

This Owner's Manual is provided and hosted by [Appliance Factory Parts](http://Appliance Factory Parts).

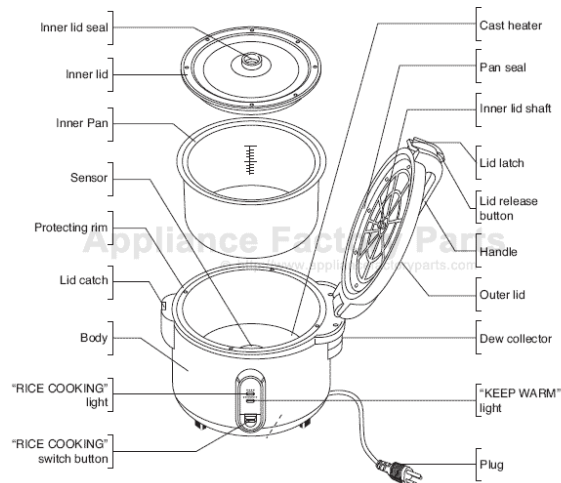

# PANASONIC SR-2363Z Owner's Manual

[Shop genuine replacement parts for PANASONIC SR-2363Z](#)



[Find Your PANASONIC Small Appliance Parts - Select From 148 Models](#)

----- Manual continues below -----

USA

Panasonic®

## Operating Instructions

Electronic Rice Cooker/Warmer **for commercial use**

使用説明書

商業用途 電鍋/保溫鍋

## Manuel d'utilisation

Cuisiseur et réchauffeur de riz électronique **à usage professionnel**

## Instrucciones de funcionamiento

Arrocera/calentador de arroz eléctrico **de uso comercial**

사용설명서

상용 전기밥솥/보온기

## Hướng Dẫn Sử Dụng

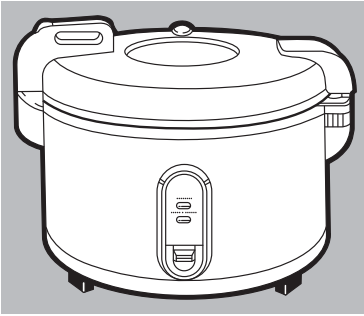
Nồi Cơm Điện/Nồi Hấp để **sử dụng thương mại**Model No. / 型號 / N° de modèle / N° de modelo / 모델번호 / Kiểu số **SR-2363Z**

## Contents

## 目錄

## Table des matières

IMPORTANT SAFEGUARDS .....	2	重要的安全措施 .....	12	PRÉCAUTIONS À PRENDRE .....	22
Safety Precautions .....	3-4	安全措施 .....	13-14	Précautions de sécurité .....	23-24
Usage Precautions .....	5	使用注意事項 .....	15	Précautions d'utilisation .....	25
Parts Identification .....	6	零件名稱 .....	16	Identification des pièces .....	26
How to Cook Rice .....	7-8	蒸煮方法 .....	17-18	Comment effectuer la cuisson .....	27-28
To Keep Cooked Rice Warm and Tasty .....	8	保持煮好的飯溫熱美味 .....	18	Pour conserver la chaleur et le goût du riz .....	28
How to Clean .....	9	清潔方法 .....	19	Comment nettoyer .....	29
Troubleshooting .....	10	故障處理 .....	20	Guide de dépannage .....	30
Specifications .....	10	規格 .....	20	Spécifications .....	30
Memo .....	11	備忘錄 .....	21	Note .....	31
Customer Service Directory .....	62				
Thank you very much for purchasing Panasonic product. Please read the IMPORTANT SAFEGUARDS on page 2, Safety Precautions on page 3-4 and Usage Precautions on page 5 before use. Please carefully read these instructions before use, and keep these instructions for future use.		非常感謝您購買 Panasonic 產品。 請閱讀第12頁的重要的安全措施、使用前請參閱第13-14頁的安全措施和第15頁的使用注意事項。 使用前請小心細讀本說明書，並保存本說明書以作日後參考。		Merci beaucoup d'avoir acheté produit Panasonic. Prière de lire attentivement les paragraphes Consignes de PRÉCAUTIONS À PRENDRE en page 22. Veuillez lire les Précautions de sécurité en page 23-24 ainsi que les Précautions d'utilisation en page 25 avant utilisation. Veuillez lire attentivement ces instructions avant utilisation et les conserver pour une utilisation ultérieure.	

## Contenidos

## 차례

## Mục lục

MEDIDAS DE SEGURIDAD IMPORTANTES ..	32	중요한 안전 장치 .....	42	CÁC BỘ PHẬN AN TOÀN QUAN TRỌNG ..	52
Precauciones de seguridad .....	33-34	안전 예방책 .....	43-44	Đề Phòng Vi An Toàn .....	53-54
Precauciones de uso .....	35	사용 예방책 .....	45	Đề Phòng Khi Sử Dụng .....	55
Identificación de partes .....	36	각 부분의 명칭 .....	46	Nập biết Bộ phận .....	56
Cómo cocinar .....	37-38	밥짓기 .....	47-48	Cách nấu cơm .....	57-58
Para mantener el arroz cocinado caliente y sabroso .....	38	지은 밥을 맛있게 보온하는 방법 .....	48	Để giữ cơm nóng và ngon .....	58
Cómo limpiarla .....	39	손질방법 .....	49	Cách Lau Chùi .....	59
Resolución de problemas .....	40	문제해결 .....	50	Giải quyết sự cố .....	60
Especificaciones .....	40	제품 사양 .....	50	Chi tiết kỹ thuật .....	60
Nota .....	41	메모 .....	51	Viết tắt .....	61
Muchas gracias por comprar producto Panasonic. Por favor lea las MEDIDAS DE SEGURIDAD IMPORTANTES en la página 32, Precauciones de seguridad en la página 33-34 y Precauciones de uso en la página 35 antes de utilizar. Por favor lea estas instrucciones antes de utilizar, y guárdelas para utilizarlas en el futuro.		Panasonic 제품을 구입해 주셔서 대단히 감사드립니다. 본 제품을 사용하기 전에 42페이지의 중요한 안전 장치, 43-44페이지의 안전 예방책과 45페이지의 사용 예방책을 반드시 읽어보시기 바랍니다. 본 제품을 사용하기 전에, 다음의 설명을 모두 읽고 보고 나중에 사용할 수 있도록 안전하게 보관해 두시기 바랍니다.		Xin cảm ơn quý vị đã mua sản phẩm của Panasonic. Xin hãy đọc CÁC BỘ PHẬN AN TOÀN QUAN TRỌNG ở trang 52, Đề Phòng Vi An Toàn ở trang 53-54 và Đề Phòng Khi Sử Dụng ở trang 55 trước khi sử dụng. Xin hãy đọc các hướng dẫn này trước khi sử dụng và giữ chúng để sử dụng trong tương lai.	

# IMPORTANT SAFEGUARDS

When using electrical appliances, basic safety precautions should always be followed including the following:

1. Read all instructions.
2. Do not touch hot surfaces. Use handles or knobs.
3. To protect against electrical shock, do not immerse cord, plugs, or (state specific part or parts in question) in water or other liquid.
4. Close supervision is necessary when any appliance is used by or near children.
5. Unplug from outlet when not in use and before cleaning. Allow to cool before putting on or taking off parts.
6. Do not operate any appliance with a damaged cord or plug or after the appliance malfunctions or has been damaged in any manner.  
Return appliance to the nearest authorized service facility for examination, repair, or adjustment.
7. The use of accessory attachments not recommended by the appliance manufacturer may cause injuries.
8. Do not use outdoors (this item may be omitted if the product is specifically intended for outdoor use).
9. Do not let cord hang over edge of table or counter, or touch hot surfaces.
10. Do not place on or near a hot gas or electric burner, or in a heated oven.
11. Extreme caution must be used when moving an appliance containing hot oil or other hot liquids.
12. Always attach plug to appliance first, then plug cord into the wall outlet. To disconnect, turn any control to "off", then remove plug from wall outlet.
13. Do not use appliance for other than intended use.

## 14. SAVE THESE INSTRUCTIONS.

This product is intended for commercial use.

### CAUTION :



- a. A short power-supply cord (or detachable power-supply cord) is to be provided to reduce the risk resulting from becoming entangled in or tripping over a longer cord.
- b. Longer detachable power-supply cords or extension cords are available and may be used if care is exercised in their use.
- c. If a longer detachable power-supply cord or extension cord is used,
  - (1) The marked electrical rating of the cord set or extension cord should be at least as great as the electrical rating of the appliance, and
  - (2) The cord should be arranged so that it will not drape over the countertop or tabletop where it can be pulled on by children or tripped over unintentionally.

If the appliance is of the grounded type, the extension cord should be grounding-type 3-wire cord.



# Safety Precautions

This instruction manual provides operating instructions and cautions for appropriate use.











## Warning and Caution for important safeguards

	<b>Warning :</b>	This sign means [It may result in severe injuries or death].
	<b>Caution :</b>	This sign means [It may result in injuries or malfunction].

The samples of symbols used in this manual are described below.

	This sign means prohibited action.
	This sign means required action.

 **Warning**

<p><b>Plug in the AC cord to the outlet firmly.</b></p> <p> (Not doing so can result in an electrical shock or fire due to generation of heat.)</p> <p>Do not use a damaged plug or outlet.</p> <hr/> <p><b>Do not plug or unplug the rice cooker with wet hands.</b></p> <p> (Doing so can result in an electrical shock.)</p> <p>Do not use wet hands.</p> <hr/> <p><b>Do not place your hands or face over or near the steam vent.</b></p> <p> </p> <p>Do not touch</p> <p>(Exposure to steam can cause personal injury.)</p>	<p><b>Do not damage the AC cord or plug.</b></p> <p> Do not disassemble, expose to heat or fire, twist, pull, place heavy objects on or tie the AC cord in a bundle.</p> <p>Prohibited</p> <p>(A damaged cord or plug can lead to electrical shock or fire.)</p> <p>If the AC cord or plug is damaged, consult your nearest retailer or service center for repair.</p> <hr/> <p><b>Do not insert metal objects such as pins or needles, or any other objects in the exhaust outlets, or in any other portion of the unit.</b></p> <p> Particularly, do not insert clips, wire or any metal objects into the unit.</p> <p>Prohibited (Doing so can lead to an electrical shock or malfunction.)</p> <hr/> <p> <b>This appliance is not intended for use by persons (including children) with reduced physical, sensory or mental capabilities, or lack of experience and knowledge, unless they have been given supervision or instruction concerning use of the appliance by a trained person responsible for their safety.</b></p> <p>(It may result in injuries.) <b>Children should not be allowed to be in the area around the unit while it is in operation.</b></p>	<p><b>Do not allow the plug to become dusty.</b></p> <p> (Dust accumulation can lead to fire or a malfunction.)</p> <p>Unplug and wipe with a dry cloth.</p> <hr/> <p><b>Do not operate the appliance with damaged AC plug or cord.</b></p> <p> (It may result in an electrical shock or fire.)</p> <p>Prohibited</p> <hr/> <p><b>Be sure the household supply voltage matches the required voltage of the appliance (120V in the U.S.).</b></p> <p> (It may cause electrical shock or fire.)</p>
---	--	---

# Safety Precautions

## Warning

To prevent personal injury, close supervision is necessary when the appliance is used near children, or persons handicapped in any manner.



(It may result in burning injuries.)

Do not immerse the appliance in water or other liquids.



(Doing so can result in personal injury.)  
If water leaks inside the appliance, consult your nearest retailer or service center.

Do not attempt to disassemble or repair the unit yourself.



Do not disassemble.

(Doing so can result to electrical shock.)  
There are no self-servicing parts inside. Refer servicing to qualified personnel.

## Caution

Do not operate the appliance near water, near a heat source, or expose to high humidity.



Prohibited (Doing so can lead to an electrical shock or fire.)

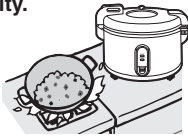

The appliance becomes hot when in use, especially the lid and inner pan. This is normal. Allow to cool before touching them.



Do not touch



Do not touch the lid and inner pan.

Doing so can lead to personal injury.

Allow the inner pan to cool before handling.



(Handling a hot pan can lead to personal injury.)

Do not place the appliance on an unstable surface.



Prohibited

(It may overturn causing personal injury or resulting in a fire.)

Do not press on the Lid release button when the appliance is being carried or moved.



Do not touch

(The lid may open and the appliance may fall causing injury or damage.)

To prevent electric shock, be sure to grasp the plug itself when disconnecting it; never unplug by pulling the AC cord.



(Firmly grasp the appliance while unplugging it.)  
(It may result in electrical shock or electrocution.)

Do not substitute the inner pan with other containers.

※ Do not use damaged inner pan with the rice cooker. Please contact authorized service agent for replacement.



Prohibited

(It may overheat causing personal injury or cause the appliance not to perform correctly.)

Unplug the appliance when not in use. Be sure to grasp the AC plug; not the cord.



Unplug

(Pulling the cord may cause it to become damaged, leading to an electrical shock.)

Do not place the appliance near a wall or furniture.



Prohibited

(The steam may cause color changes or deformation of any nearby objects.)

Do not use other than the provided cord set and do not use the cord set for other appliances.



Prohibited

(It may result in electrical shock or fire)

# Usage Precautions

## Avoiding damage to the appliance.

**Do not cover the outer lid with a cloth.**

The outer lid may become deformed, cracked or discolored and result in malfunction.

**Do not place the appliance in direct sunlight.**

**Do not substitute the inner pan with other container.**

**Always keep the outside bottom of the inner pan and the cast heater clean and dry.**

Otherwise, it may result in malfunction of the unit.

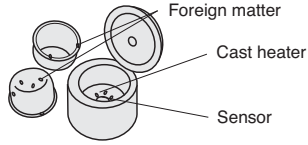

## Avoiding damage to the inner pan.

**Do not leave the rice scoop or any other objects inside the inner pan.**

The inner pan should be cleaned immediately after cooking.

**Do not use the inner pan as mixing utility.**

**Do not use metal utensils that can scratch or crack the inner pan.**

The coated surface of the inner pan will gradually wear away, so use with care.

**Do not tap or rub the inner surface of the inner pan. Clean only with a sponge or soft cloth. Do not use a scouring pad.**

English

# Parts Identification

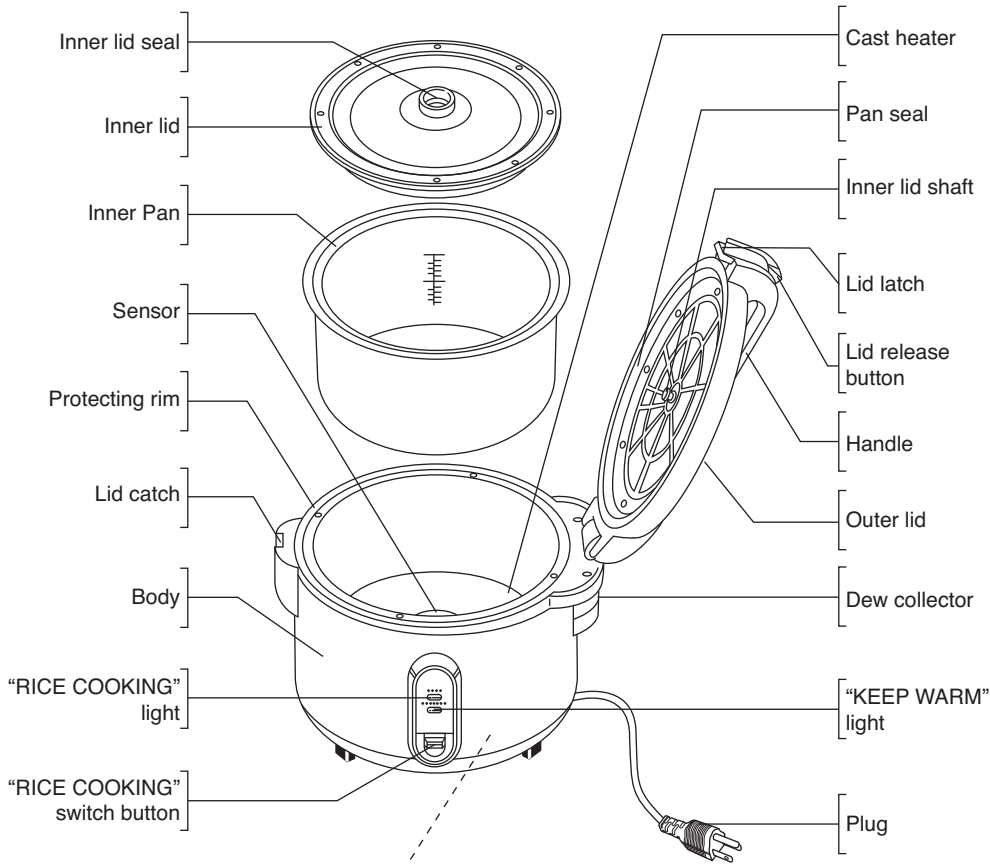

Before using, remove the sheet of paper placed between the cast heater and inner pan.

If the supply cord is damaged, it must be replaced by the manufacturer, its service agent or similarly qualified persons in order to avoid a hazard.

## Accessories



Measuring cup  
(approx. 180 ml)  
(1 PC.)



Rice scoop  
(1 PC.)



Scoop holder  
(1 PC.)

## Removal and attachment of scoop holder

- Attachment  
Face the magnet of the scoop holder towards the body of the rice cooker and gently attach to the surface.
- Removal  
Slide the scoop holder upward and pull it off.



- Do not attempt to forcibly pull the scoop holder off the rice cooker body since this could cause surface damage.

# How to Cook Rice

1

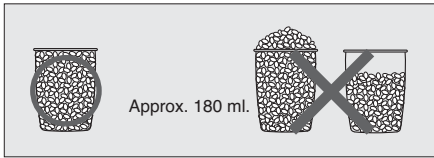

Measure the rice using the measuring cup provided.

2

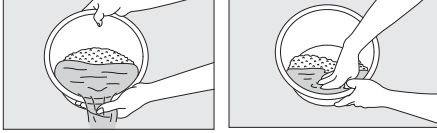

Use tap water to rinse the rice for fresher smelling rice.

Rinse and wash the rice until the water becomes relatively clear.

Rinse the rice

Do not rinse the rice by using the inner pan.

Rinse the rice in a separate bowl. Do not rinse the rice in the provided inner pan as non-stick coating may be damaged. Pour the washed rice into the inner pan.

3

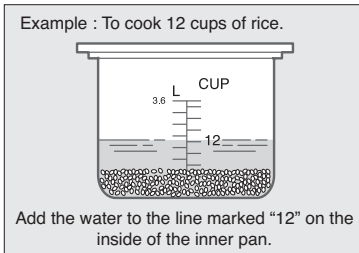

Pour in the desired amount of water

Set the inner pan on a flat surface when adding the water. Add the desired amount of water following the scale marked on the inner pan. Hot water is not recommended for cooking as it may result in soggy rice.

English

4

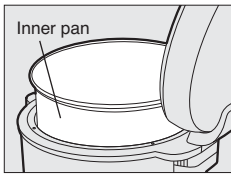

Put the inner pan into the body.

Wipe water off around the surface of the inner pan before placing into a rice cooker, otherwise it may result in strange noise during cooking. Be sure that the inner pan is directly in contact with the cast heater. Improper contact between the inner pan and the cast heater may result in uncooked rice.

5

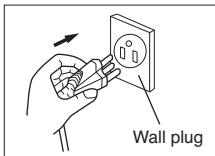

Plug in the AC cord to the power supply outlet.

Close the outer lid, plug in the AC cord to the power supply outlet.

Close the outer lid firmly. (If it is not securely closed, cooking will be affected.)

# How to Cook Rice

6

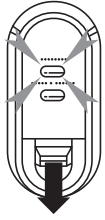

Press the switch to start cooking.  
The "RICE COOKING" lamp lights up.

## Press switch.

Do not open the outer lid or unplug the appliance while it is operating.  
Please ensure that the switch is pressed and the "RICE COOKING" lamp lights up properly.  
(The rice will not be cooked in warming mode.)

7

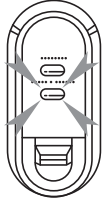

The "KEEP WARM" lamp lights up to indicate warming mode.

## After the rice is cooked, it is recommended to let it steam and warm for another 15 minutes. Then scoop and mix the rice well.

After the rice is cooked, the appliance will automatically switch to warming mode.  
Let the rice steam and warm for another 15 minutes without opening of the outer lid.  
Scoop and mix the rice well.  
Unplug the appliance when it is not in use.

# To Keep Cooked Rice Warm and Tasty

Rinse the rice until it becomes relatively clear.  
After the rice has been steamed and warmed, scoop and mix the rice gently.  
Do not leave the rice scoop inside the inner pan.  
Do not warm the rice for more than 4 hours. (It may result in color change and bad smell.)  
Do not use the rice cooker to warm other kinds of food. It is for rice only.  
Do not warm cold rice.

### Note:

Variations in the room temperature may cause the rice to discolor and lose its fresh smell.  
Unplug the rice cooker when it is not be used.  
Clean the dew collector located on the side of the rice cooker by pouring out the water, cleaning and sanitizing it after every use.

8

# How to Clean

- Be sure to unplug and carry out these operations after the unit has cooled down.
- DO NOT use objects such as benzine, thinner, cleansing powder or metal scrubbers.

## Body / Outer lid / Protecting rim / Inner lid

Wipe with a damp cloth and a non abrasive cleaner then rinse and sanitize.

\*Remark : Clean after every use.

## Inner pan

Wash with a dishwashing detergent, or soft cloth. Wipe off any moisture on the outside and sanitize.

## Cast heater

If any objects stick on the bottom of the pan or cast heater, remove them immediately.

Object, such as rice or other food debris may cause a malfunction and damage.

## Dew collector

Remove, clean and sanitize after every use.

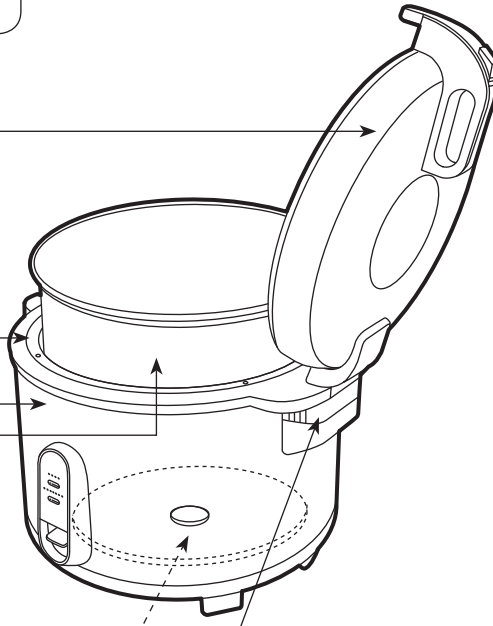

English

## Accessories



Measuring cup



Rice scoop



Scoop holder

Wash with sponge and dishwashing liquid after use.

# Troubleshooting

Check Items	Rice cooking					Keep warm			No reaction to any switch operation	Produces a strange sound
	Too hard	Uneven cooking (The core of rice remains.)	Too soft	Viscous juice overflows	Burnt rice at the bottom of the inner pan	Rice produces an odor	Changes in color	Gets too dry		
• Are the volume of rice and the volume of water correct?	●	●	●	●	●				<ul style="list-style-type: none"> <li>• No current supplied. Pull out the plug and check the breaker.</li> </ul>	<ul style="list-style-type: none"> <li>• "Pang" sound produced during cooking is the sound of bursting of water drops under the action of thermal expansion on the bottom (outside) of the inner pan.</li> </ul>
• Is the rice rinsed adequately?				●	●	●				
• Is the bottom of the inner pan dented?	●	●			●					
• Is there any foreign matter sticking to the outside of the inner pan or the sensor?	●	●	●		●	●	●			
• Is the rice being cooked with oil?	●	●				●				
• Has the rice been well fluffed after cooking?	●		●							
• Is the keep warm continuing for more than 12 hours? /						●	●	●		
• Is the volume of rice too small during a keep warm?										
• Is the Keep Warm being used with the scoop in it?						●				
• Is the Keep Warm setting being used on cold rice?						●				
• Is the outer lid securely closed?				●		●		●		
• Is the inner pan clean?					●	●				
• AC cord unplugged or switched turned off during rice cooking?		●				●				

# Specifications

<b>Model No.</b>	<b>SR-2363Z</b>	
<b>Power supply</b>	120V ~ 60Hz.	
<b>Power consumed</b>	<b>During cooking</b>	1400W
	<b>During keep warm</b>	124W
<b>Capacity</b>	1.0 - 3.6 L (5 - 20 cups dry rice)	
<b>Weight (approx.)</b>	19.2 lbs (8.7 kg)	
<b>Accessories</b>	Rice scoop, Measuring cup, Scoop holder	