

This Owner's Manual is provided and hosted by [Appliance Factory Parts](http://www.appliancefactoryparts.com).

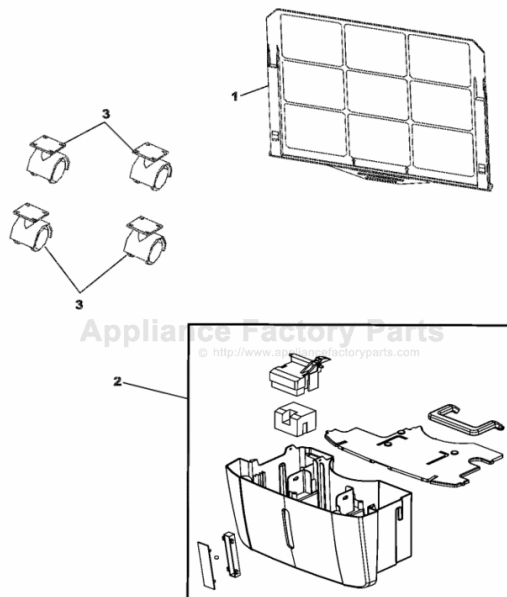

# FRIGIDAIRE FDL70S1A Owner's Manual

[Shop genuine replacement parts for FRIGIDAIRE  
FDL70S1A](#)



[Find Your FRIGIDAIRE Dehumidifier Parts - Select From 306 Models](#)

----- Manual continues below -----

---

# OWNER'S GUIDE

---

## READ AND SAVE THESE INSTRUCTIONS

Record Model No. and Serial No. of this dehumidifier in space provided below. These numbers are printed on the nameplate located behind the bucket.

Model No. \_\_\_\_\_

Serial No. \_\_\_\_\_

**IMPORTANT:** Keep a copy of your bill of sale. The date on the bill establishes the warranty period should service be required. If service is performed, it is in your best interest to obtain and keep all receipts.

### Register Your Product

The self-addressed PRODUCT REGISTRATION CARD should be filled in completely, signed, and returned to the Frigidaire Company.

### Contents

2	Warranty
3	Important Safety Instructions
3	Location
3	How It Works
4	Operation & Features
6	Fault Codes
7	Removing Collected Water
8	Care and Cleaning
8	Storage
9	Avoid Service Checklist

Operate dehumidifier only as instructed in this Owner's Guide. These instructions are not meant to cover every possible condition and situation that may occur. Common sense and caution must be used when installing, operating, and maintaining any appliance.

# DEHUMIDIFIER

---

# DEHUMIDIFIER WARRANTY

Your product is protected by this warranty

Your appliance is warranted by Electrolux. Electrolux has authorized Frigidaire Consumer Services and their authorized servicers to perform service under this warranty. Electrolux authorizes no one else to change or add to any of these obligations under this warranty. Any obligations for service and parts under this warranty must be performed by Frigidaire Consumer Services or an authorized Frigidaire servicer.

	WARRANTY PERIOD	FRIGIDAIRE, THROUGH ITS AUTHORIZED SERVICERS, WILL:	THE CONSUMER WILL BE RESPONSIBLE FOR:
<b>FULL ONE-YEAR WARRANTY</b>	One year from original purchase date.	Pay all costs for repairing or replacing parts of this appliance which prove to be defective in materials or workmanship.	Costs of service calls that are listed under <b>NORMAL RESPONSIBILITIES OF THE CONSUMER.*</b>
<b>LIMITED 2ND-5TH YEAR WARRANTY (Sealed System)</b>	Second through fifth years from original purchase date.	Repair or replace any parts in the Sealed Refrigeration System (compressor, condenser, evaporator and tubing) proves to be defective in materials or workmanship.	Diagnostic costs and any removal, transportation and reinstallation costs which are required because of service. Costs for labor, parts and transportation other than with respect to the Sealed Refrigeration System.

**\*NORMAL RESPONSIBILITIES OF THE CONSUMER**

**This warranty applies only to products in ordinary household use, and the consumer is responsible for the items listed below.**

1. Proper use of the appliance in accordance with instructions provided with the product.
2. Proper installation by an authorized servicer in accordance with instructions provided with the appliance and in accordance with all local plumbing, electrical and/or gas codes.
3. Proper connection to a grounded power supply of sufficient voltage, replacement of blown fuses, repair of loose connections or defects in house wiring.
4. Expenses for making the appliance accessible for servicing, such as removal of trim, cupboards, shelves, etc., which are not a part of the appliance when it was shipped from the factory.
5. Damages to finish after installation.
6. Damage to unit after remove from packaging carton.

**EXCLUSIONS**

**This warranty does not cover the following:**

1. CONSEQUENTIAL OR INCIDENTAL DAMAGES SUCH AS PROPERTY DAMAGE AND INCIDENTAL EXPENSES RESULTING FROM ANY BREACH OF THIS WRITTEN OR ANY IMPLIED WARRANTY.  
Note: Some states do not allow the exclusion or limitation of incidental or consequential damages, so this limitation or exclusion may not apply to you.
2. Service calls which do not involve malfunction or defects in workmanship or material, or for appliances not in ordinary household use. The consumer shall pay for such service calls.
3. Damages caused by services performed by persons other than authorized Frigidaire servicers; use of parts other than Frigidaire Genuine Renewal Parts; obtained from persons other than such servicers; or external causes such as abuse, misuse, inadequate power supply or acts of God.
4. Products with original serial numbers that have been removed or altered and cannot be readily determined.

**IF YOU NEED SERVICE**

Keep your bill of sale, delivery slip, or some other appropriate payment record. The date on the bill establishes the warranty period should service be required. If service is performed, it is in your best interest to obtain and keep all receipts. This written warranty gives you specific legal rights. You may also have other rights that vary from state to state. Service under this warranty must be obtained by following these steps, in order:

1. Contact Frigidaire Consumer Services or an authorized Frigidaire servicer.
2. If there is a question as to where to obtain service, contact our Consumer Relations Department at:

Frigidaire  
P.O. Box 212378  
Augusta, GA 30917  
**800-444-4944**



CANADA  
Electrolux Canada Group  
6150 McLaughlin Road  
Mississauga, Ontario L5R 4C2  
**1-866-213-9397**

Product features or specifications as described or illustrated are subject to change without notice. All warranties are made by Electrolux. This warranty applies only in the 50 states of the U.S.A., Puerto Rico and Canada.

**FOR SERVICE CALL 1-800-444-4944.**

## Important Safety Instructions

**⚠ WARNING** Avoid fire hazard or electric shock. Do not use an extension cord or an adaptor plug. Do not remove grounding prong from power cord.

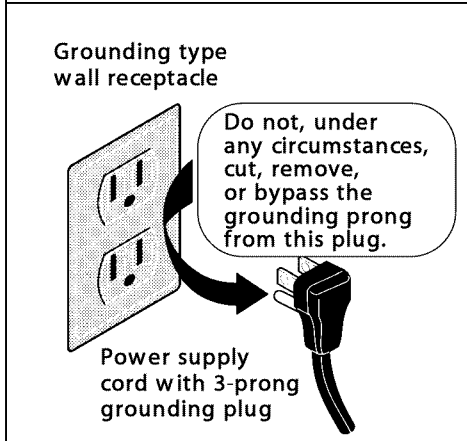

**Read all instructions before using this dehumidifier.** To reduce the risk of fire, electric shock, or injury to persons when using your dehumidifier, follow basic precautions, including the following:

### **⚠ WARNING** For Your Safety

Do not store or use gasoline or other flammable vapors and liquids in the vicinity of this or any other appliance. Read product labels for flammability and other warnings.

### **⚠ WARNING** Child Safety Precautions

- Destroy the carton, plastic bags, and any packing materials immediately after the dehumidifier is unpacked. Children should never use these items for play.
- Do not leave children unattended in an area where the appliance is operating.
- Do not allow them to sit or stand on the appliance.

### **⚠ WARNING** Electrical Information

- For your safety and protection, this dehumidifier is equipped with a three-prong grounding plug on the power cord. **Do not, under any circumstances, cut or remove the round ground prong from the plug.**
- Your dehumidifier must be plugged directly into a properly grounded and polarized three-prong receptacle. If the wall receptacle you intend to use will not accept a three-prong plug, or if you are not sure the outlet is adequately grounded or protected by a time delay fuse or circuit breaker, have a qualified electrician install the proper outlet according to the National Electrical Code and applicable local codes and ordinances. **Do not use an extension cord or an adaptor plug.**
- Never unplug the dehumidifier by pulling on the power cord. Always grip the plug firmly and pull straight out from the receptacle.
- Do not pinch, bend, or knot the power cord.

## Location

### Selecting a Location

#### IMPORTANT:

1. Dehumidifier must be operated in an enclosed area to be most effective. Close all doors, windows, and other outside openings to the room. The effectiveness of the dehumidifier depends on the rate at which new moisture-laden air enters the room.
2. Place dehumidifier in a location that does not restrict airflow through the front of the unit or out of the louvers on the sides of cabinet.
3. A dehumidifier operating in a basement will have little or no effect in drying an adjacent enclosed storage area, such as a closet, unless there is adequate circulation of air in and out of the area. It may be necessary to install a second dehumidifier in the enclosed area for satisfactory drying.
4. The dehumidifier must be installed on a level floor that will support it with a full bucket of water.
5. There should be a minimum of 12 inches clearance around the dehumidifier.

## How It Works

When the unit is started, the fan begins to pull moisture-laden air across the dehumidifying coils. The coils condense or draw moisture from the air, and air flows through the side louvers into the room as dry, warm air. Moisture removed from air is collected in a bucket on the front of the dehumidifier.

The unit is designed to operate between 41°F (5°C), and 96°F (35°C).

If the unit is switched off and needs to be switched on again, wait three minutes before doing so.

Make sure the tank is fitted correctly otherwise unit will not turn on.

## OPERATION & FEATURES

Allow the unit to reach room temperature before operating.

To begin operating the dehumidifier, follow these steps:

1. Plug the power cord into a properly grounded 115 volt AC outlet. Note the POWER indicators will illuminate.

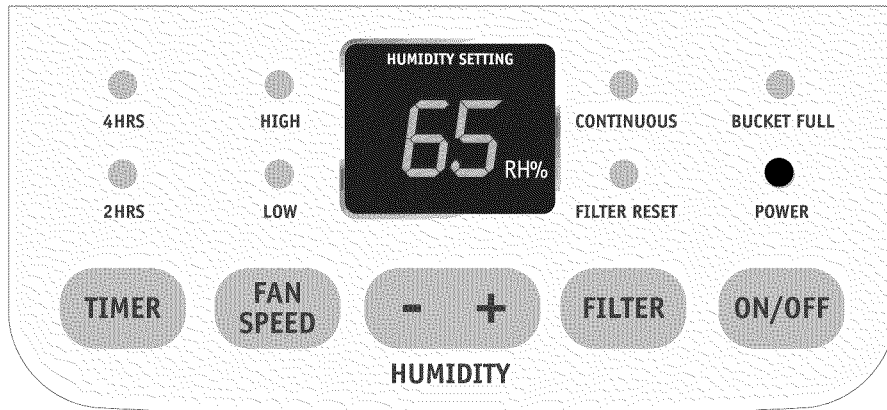

2. To turn the unit on press the ON/OFF button. The unit will run in the factory setting of CONTINUOUS and high fan speed. After a few seconds the unit will display the actual room's relative humidity. This will be the case after each and every change of setting. It is recommended you leave the unit running in the CONTINUOUS setting for the first three or four days until the sweating and dampness odors have stopped.

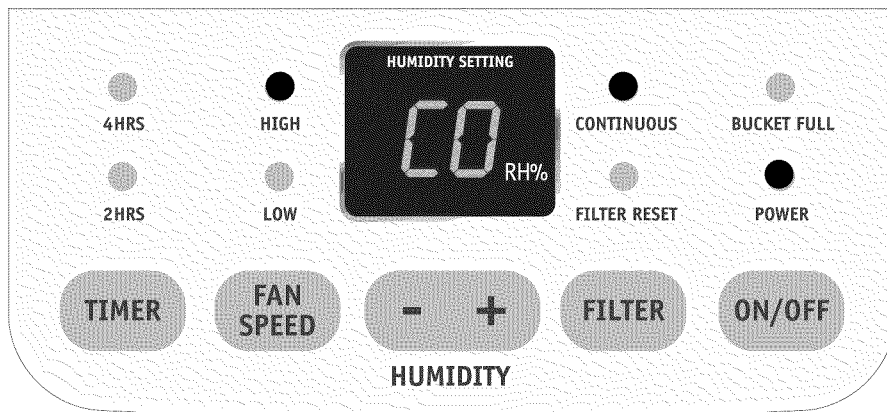

3. After a few days when the Relative Humidity has declined, press the HUMIDITY + or - buttons to choose a value between 35% to 80%, so the room is kept at a comfortable concentration. Pressing the + or - buttons will change the humidity selection in 5% increments. If at any time you want to return to the CONTINUOUS Mode, pressing the HUMIDITY - button will lower the Relative Humidity through the 5% increments until the Continuous indicator is lit and the display reads CO.

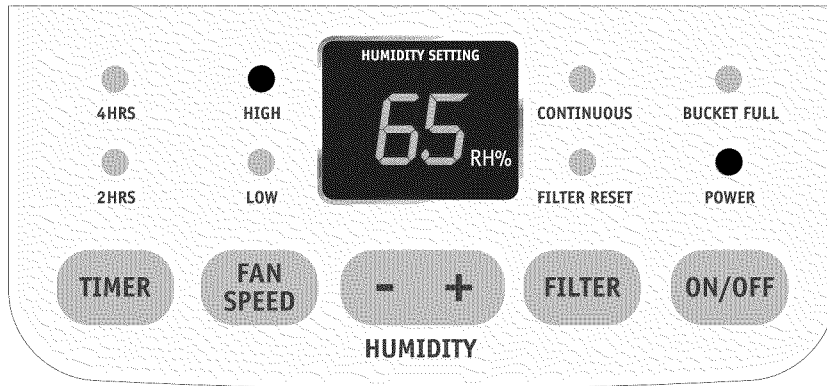

4. You can also use the FAN button to change the fan speed to HIGH (⤴) or LOW (⤵). The indicator light will show the setting you have selected. A higher fan speed will result in quicker moisture removal.

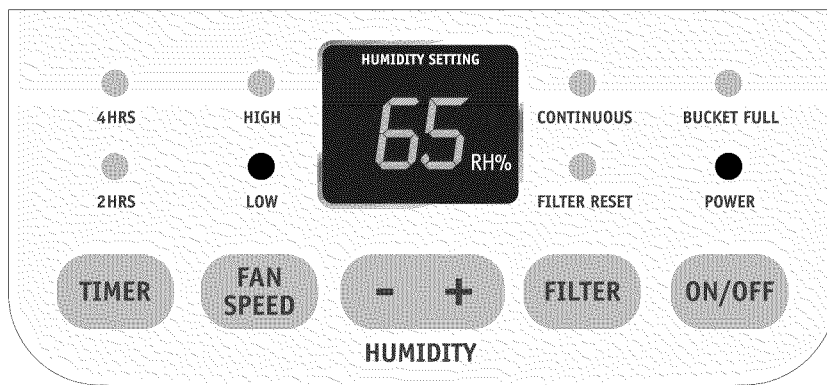

5. The FILTER RESET light will illuminate after 250 hours of operation. At this time refer to the Care and Cleaning section to remove and clean the filter. Once the filter has been cleaned, to extinguish the light simply press the FILTER button.

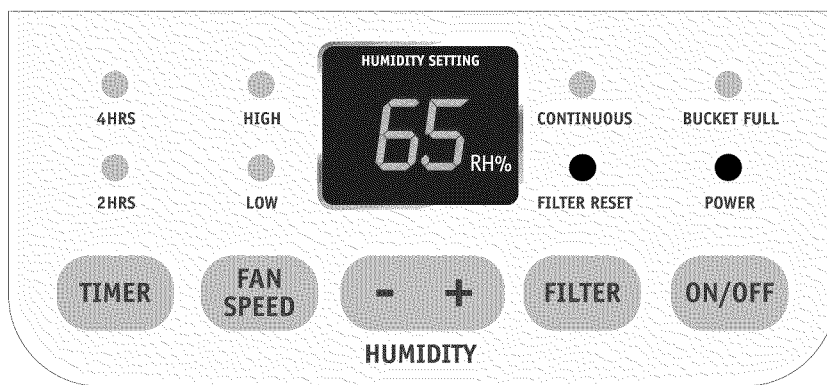

6. The TIMER function enables you to either start or stop the unit in the choice of 2 or 4 hours. If the unit is running then selecting TIMER at 2 hours will turn the unit off after 2 hours. If the unit is off pressing the TIMER button and selecting say 4 hours, the unit will turn on after 4 hours and remain working in the selected mode. The POWER indicator must be lit to make sure power is being supplied to the unit.

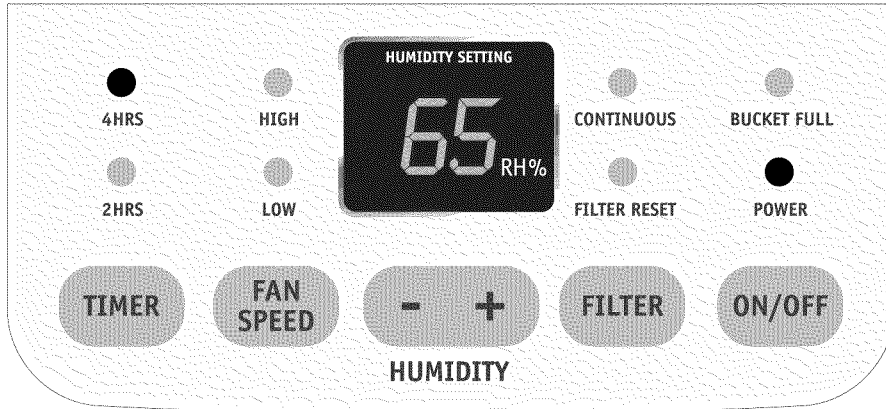

7. To shut the unit down, press the ON/OFF button. Note: the power indicator will still be lit when the unit is turned off. Only removing the plug will extinguish these lights.

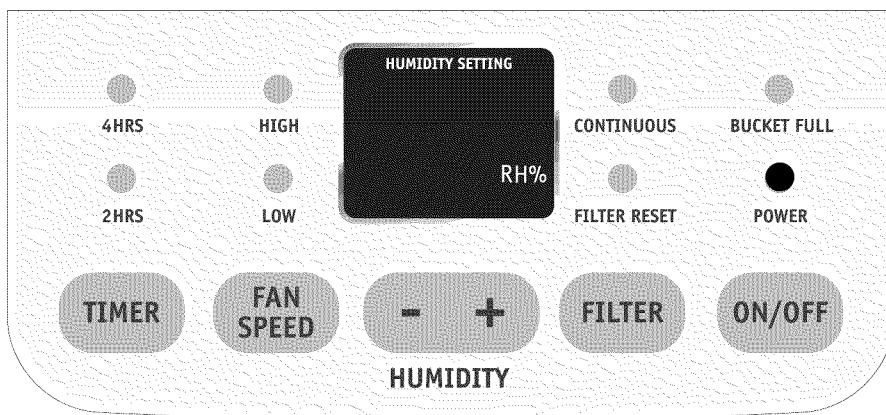

## FAULT CODES

If the display reads "F1" or "F2", a sensor has failed. Contact your Authorized Frigidaire Service Center.

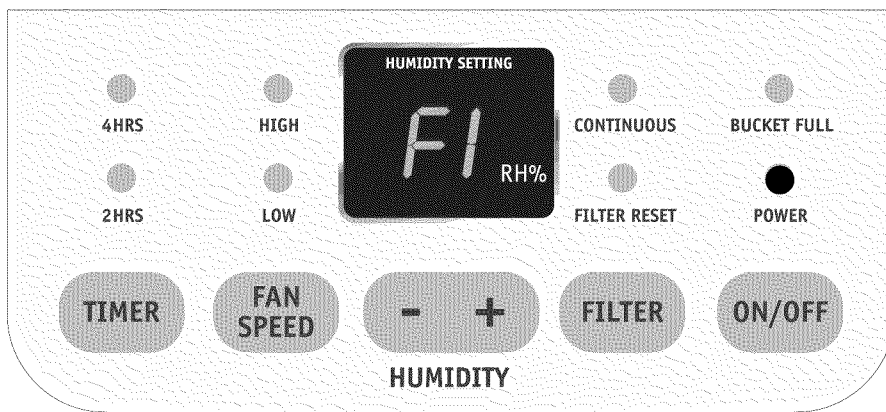

## REMOVING COLLECTED WATER

1. Emptying the Bucket:
  - a. When the bucket is full the unit will shut down and the BUCKET FULL indicator light will illuminate.

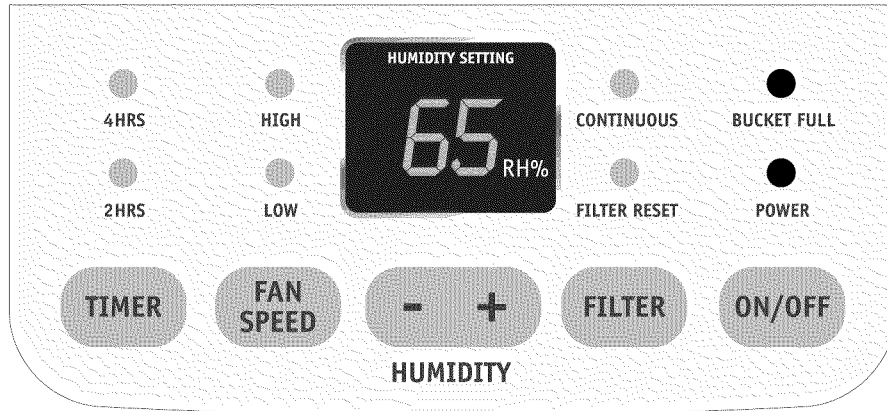

- b. Do not move the unit at this point otherwise water may spill on the floor.
    - c. Press sides of bucket gently to unclip the bucket from the unit.
    - d. Remove the bucket as shown in the photographs below and empty the bucket.

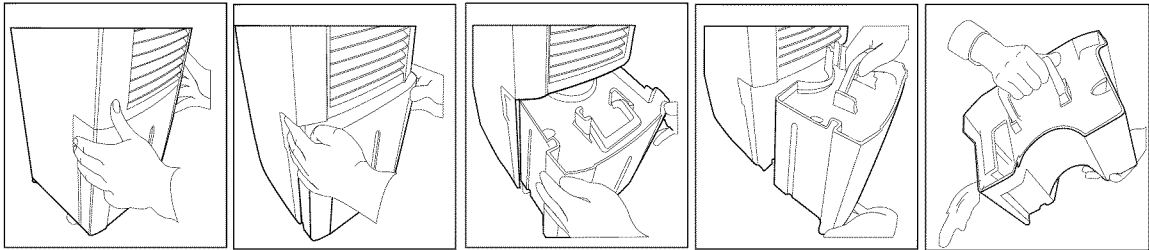

- e. Replace the empty bucket back into the unit and once seated correctly the unit will start up again.
      - f. You should hear a click when the bucket is in the correct position.

If the bucket full light does not extinguish, check that the float is correctly snapped in place as indicated by the diagram.

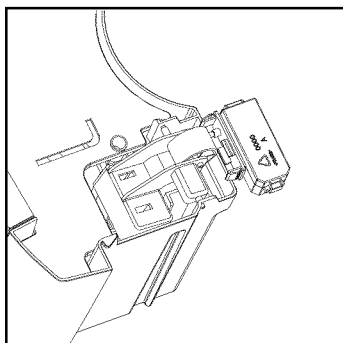

## 2. Continuous Drainage:

- a. For constant drainage operation, you will need a garden hose and a drain nearby to discharge the water into.
- b. Remove the bucket from the unit and set aside.
- c. Lift up the side flap located on the left side of the unit as looking from the front. (fig.1)
- d. Insert the female threaded end of the hose through the opening. (fig.2)
- e. Screw the garden hose onto the threaded portion of the tray underneath the bucket opening. (fig.3)
- f. Make sure the hose is secure so there are not leaks.
- g. Direct the hose toward the drain making sure that there are no kinks that will stop the water flowing.
- h. Place the end of the hose into the drain.
- i. Place the bucket back in the unit and make sure that it is located correctly. (fig.4)
- j. Select the desired humidity setting and fan speed on the unit for continuous draining to start.

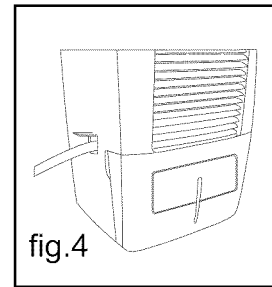
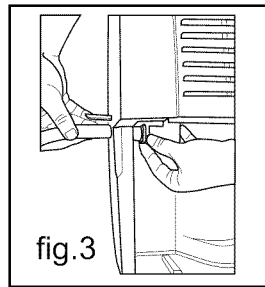
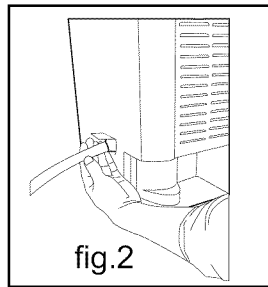
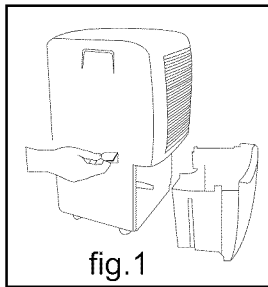

Note: If the unit stops operating check that the bucket full light is illuminated. If it is remove the bucket and empty the contents and then check the seal between the hose and the drip tray. If there is a small leak then replace the hose gasket and re-tighten the hose.

## CARE AND CLEANING

1. Filter
  - a. Remove the filter every two weeks based on normal operating conditions.
  - b. To remove the filter, remove Bucket then pull filter downwards.
  - c. Wash the filter with clean water then dry.
  - d. Re-install the filter, replace Bucket.
2. Cabinet
  - a. Dust cabinet with an oil-free cloth, or using a damp cloth.
  - b. Vacuum grill using brush attachment.
3. Water Bucket
  - a. Clean bucket with warm water and detergent.

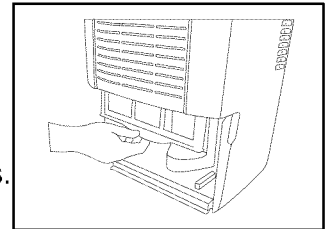

## STORAGE

When unit is not in use unplug and use the cord wrap shown for your model type.

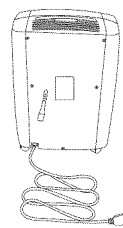
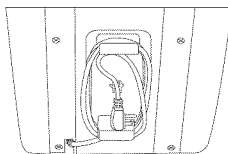

1.

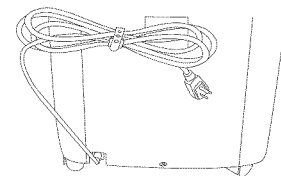

2.

## Avoid Service Checklist

Before calling for service, review this list. It may save you time and expense. This list includes common occurrences that are not the result of defective workmanship or materials in this appliance.

OCCURRENCE	SOLUTION
DEHUMIDIFIER DOES NOT OPERATE.	Plug is disconnected from outlet. Push plug firmly into wall outlet.
	House fuse blown or circuit breaker tripped. Replace fuse with time delay type or reset circuit breaker.
	The dryness level you selected has been reached. Dehumidifier automatically shuts off when selected amount of moisture has been removed from the air. If you want to remove more moisture, Select 'CONTINUOUS' by using the humidity button or knob. After the dehumidifier starts, reset the control to the desired setting.
	Bucket not installed properly. See "Removing Collected Water."
	Water in the bucket has reached its preset level. Dehumidifier automatically turns off when this occurs. Empty bucket and return bucket to position.
Dehumidifier is not turned on. Turn unit on.	
DEHUMIDIFIER RUNS TOO MUCH.	Windows or doors near dehumidifier are open to outdoors. Close all windows or doors to outside.
	Area to be dehumidified is too large. Check with your dealer to see if capacity is adequate.
	Air movement through dehumidifier is blocked. Grill or filter may be dirty. Use brush attachment of vacuum cleaner to clean grill. See "Care and Cleaning." Dehumidifier must be placed in a space that does not restrict air flowing into the rear coil or out of the front grill.
	Dehumidifier has been installed or restarted recently. The higher the moisture in the room, the longer the dehumidifier will operate.
	Dehumidifier is in the CONT mode and will remain on in this mode use the humidity button or knob to set a RH% higher level.
DEHUMIDIFIER IS OPERATING BUT ROOM IS NOT DRY ENOUGH.	Humidity setting is too high. Press the HUMIDITY button or rotate knob to a lower setting or choose CONTINUOUS for maximum dryness.
	Dehumidifier has been installed or restarted recently. The higher the moisture in the room air, the longer it takes for the room air to become dry.
	Dehumidifier does not have sufficient clearance to operate. Air flow to front grill is blocked. See "Selecting a Location."
	Room temperature is too low. Unit will not operate satisfactorily if the room temperature is below 41°F (5°C). See "Operating Conditions."
	Refer to causes under DEHUMIDIFIER RUNS TOO MUCH.
FROST APPEARS ON COILS ABOVE BUCKET OR DRIP TRAY.	Dehumidifier has been turned on recently. This is normal due to refrigerant rushing through the coil. Frost will usually disappear within 60 minutes.
	Room Temperature is too low. All models will operate satisfactorily at temperatures greater than 41°F (5°C).
NOISE IS LIKE A FAN.	Air is moving through the dehumidifier. This is a normal sound.

**If These Solutions Fail, Call 1-800-444-4944 For Frigidaire Service.**