

This Owner's Manual is provided and hosted by [Appliance Factory Parts](http://www.appliancefactoryparts.com).



PANASONIC MC-V100 Owner's Manual

[Shop genuine replacement parts for PANASONIC
MC-V100](#)



[Find Your PANASONIC Vacuum Cleaner Parts - Select From 605 Models](#)

----- Manual continues below -----

Operating Instructions

Ultra-Pro

COMMERCIAL VACUUM CLEANER
MC-V100

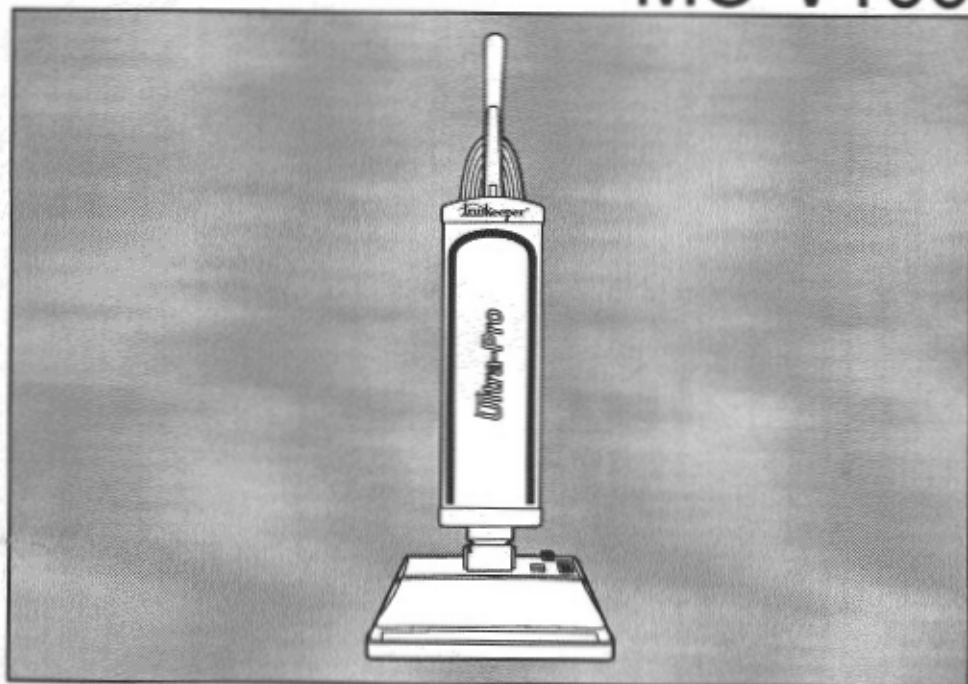

Panasonic.

Before operating your vacuum cleaner, please read these instructions completely.

C01ZAPM10U00

CONSUMER INFORMATION

Please read **IMPORTANT SAFETY INSTRUCTIONS** on page 4 before use. Read and understand all instructions.

TO OUR VALUED CUSTOMER

We are very pleased to welcome you to the Panasonic family of products. Thank you for purchasing this product. Our intent is that you become one of our many satisfied customers.

Proper assembly and safe use of your vacuum cleaner are your responsibilities. Your vacuum cleaner is intended for commercial use. The cleaner should be stored in a dry, indoor area. Read the Operating Instructions carefully for important use and safety information.

Special care is required when vacuuming certain types of carpet or floor covering. Always check the carpet or floor covering manufacturer's recommended cleaning instructions before vacuuming.

PLEASE PAY CLOSE ATTENTION TO THE WARNING AND CAUTION STATEMENTS THAT ARE FOUND THROUGHOUT THIS MANUAL.



WARNING statements are designed to alert you to the possibility of personal injury, loss of human life, and/or damage to the vacuum cleaner and/or personal property if the instructions given are not followed.



CAUTION statements are designed to alert you to the possibility of damage to the vacuum cleaner and/or personal property if the instructions given are not followed.



TO AVOID ELECTRIC SHOCK

Never vacuum damp or wet surfaces or liquids.
DO NOT store machine outdoors.
Replace worn or frayed power cord immediately.

TO AVOID ACCIDENTS

Except for hand-held cleaners, keep machine on floor - not chairs, tables, steps, stairs, etc.
Store machine promptly after each use to prevent accidents such as tripping over power cord or machine.
Use machine and accessories only in a manner intended by the manufacturer.
The use of an extension cord is not recommended.

©1998 Matsushita Electric Industrial Co., Ltd. All rights reserved.

TABLE OF CONTENTS

CONSUMER INFORMATION	2
IMPORTANT SAFETY INSTRUCTIONS	4
GROUNDING INSTRUCTIONS	5
PARTS IDENTIFICATION	6
Feature Chart	6
SPECIAL FEATURES OF CLEANER	7
Automatic Self Adjusting Nozzle	7
Edge Cleaning Feature	7
Overload Protector	7
TO OPERATE CLEANER	8
Using the Power Cord	8
On/Off Switch	8
Handle Adjustments	8
ROUTINE CARE OF CLEANER	9
Changing the Dust Bag	9
Removing/Installing the Nozzle Cover	10
Replacing the Belt	11
Cleaning the Agitator	11
Replacing the Agitator	12
Cleaning Exterior	13
Removing Clogs	13
BEFORE REQUESTING SERVICE	14
WARRANTY	15
WHAT TO DO WHEN SERVICE IS NEEDED	16

IMPORTANT SAFETY INSTRUCTIONS

When using vacuum cleaner, basic precautions should always be followed, including the following:

READ ALL INSTRUCTIONS BEFORE USING THIS VACUUM CLEANER

WARNING

To reduce the risk of fire, electrical shock, injury:

1. **DO NOT** leave vacuum cleaner when plugged in. Unplug from outlet when not in use and before servicing.
2. To reduce the risk of fire, electric shock - **DO NOT** use outdoors or on wet surfaces.
3. **DO NOT** allow to be used as a toy. Close attention is necessary when used by or near children.
4. Use only as described in this manual. Use only manufacturer's recommended attachments.
5. **DO NOT** use with damaged cord or plug. If vacuum cleaner is not working as it should, has been dropped, damaged, left outdoors, or dropped into water, return it to an authorized Panasonic Servicenter.
6. **DO NOT** pull or carry by cord, use cord as a handle, close door on cord, or pull cord around sharp edges or corners. **DO NOT** run vacuum cleaner over cord. Keep cord away from heated surfaces.
7. **DO NOT** unplug by pulling on cord. To unplug, grasp the plug, not the cord.
8. **DO NOT** handle plug or vacuum cleaner with wet hands.
9. **DO NOT** put any objects into openings. **DO NOT** use with any opening blocked; keep free of dust, lint, hair, and anything that may reduce air flow.
10. Keep hair, loose clothing, fingers, and all parts of body away from openings and moving parts.
11. **DO NOT** pick up anything that is burning or smoking, such as cigarettes, matches, or hot ashes.
12. **DO NOT** use without dust bag and/or filters in place.
13. Turn off all controls before unplugging.
14. Use extra care when cleaning on stairs.
15. **DO NOT** use cleaner to pick up flammable or combustible liquids such as gasoline or use in areas where they may be present.
16. Connect to a properly grounded outlet only. See "Grounding Instructions".

SAVE THESE INSTRUCTIONS

GROUNDING INSTRUCTIONS

This vacuum cleaner must be grounded. If it should malfunction or breakdown, grounding provides a path of least resistance for electric current to reduce the risk of electric shock. This vacuum cleaner is equipped with a cord having an equipment-grounding conductor and grounding plug. The plug must be plugged into an appropriate outlet that is properly installed and grounded in accordance with all local codes and ordinances.

DANGER

Improper connection of the equipment-grounding conductor can result in a risk of electric shock. Check with a qualified electrician or service person if you are in doubt as to whether the outlet is properly grounded. Do not modify the plug provided with the vacuum cleaner – if it will not fit the outlet, have a proper outlet installed by a qualified electrician.

This vacuum cleaner is for use on a nominal 120-volt circuit, and has a grounding plug that looks like the plug illustrated in sketch A in the following Figure. Make sure that this vacuum cleaner is connected to an outlet having the same configuration as the plug.

No adapter should be used with this vacuum cleaner.

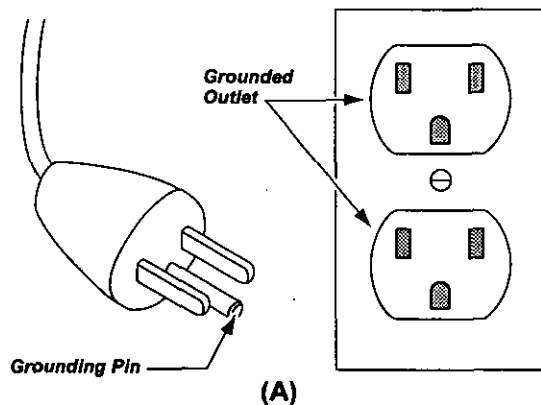

Note: Before you plug in your Panasonic vacuum cleaner, make sure that the voltage indicated on the rating plate located at the back of the vacuum cleaner is the same as your local supply.

PARTS IDENTIFICATION

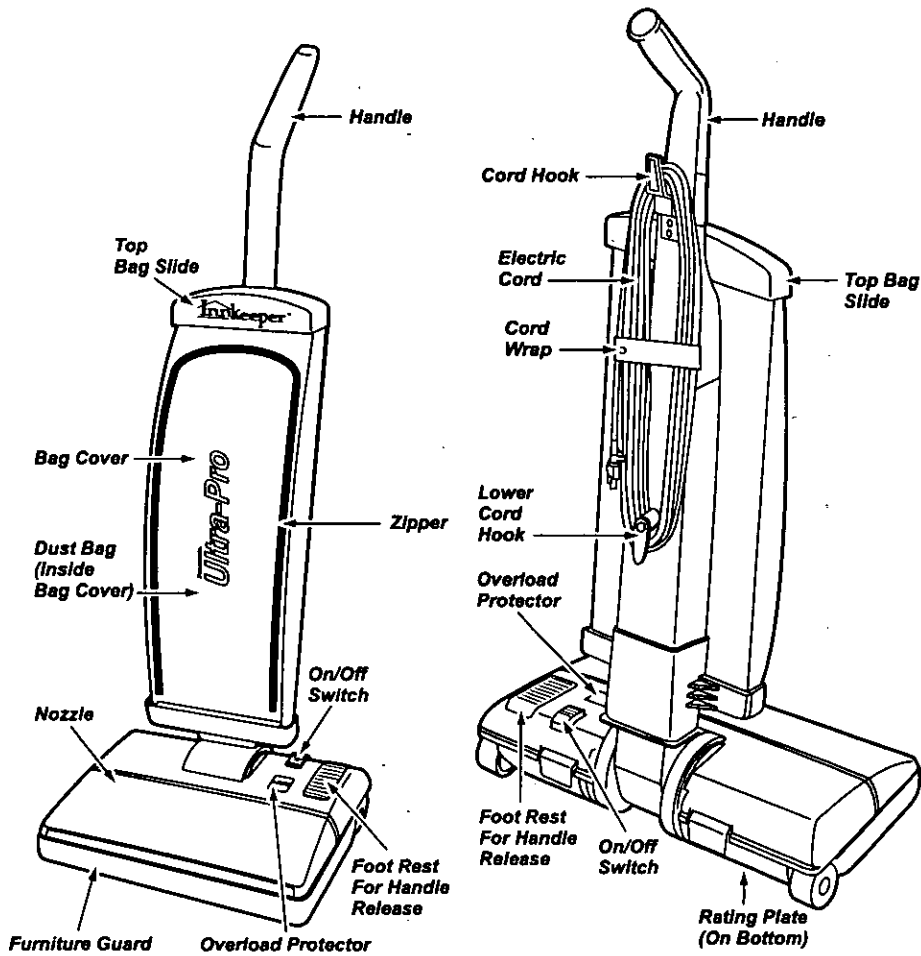

FEATURE CHART (PANASONIC UPRIGHT VACUUM CLEANER)

FEATURES	POWER	CORD WRAP	EDGE CLEANING	CORD LENGTH	CARPET HEIGHT ADJUST	OVERLOAD PROTECTOR
Model						
MC-V100	120V. AC(60Hz) 3.3 Amps	Yes	Yes	30 Ft.	Auto	Yes

SPECIAL FEATURES OF CLEANER

AUTOMATIC SELF ADJUSTING NOZZLE

Your Panasonic upright vacuum cleaner is designed with an automatic self adjusting nozzle. No manual adjustments are required. The height of the nozzle is instantly and automatically adjusted to any carpet pile height. This self adjusting feature allows the nozzle to float evenly over all carpet pile surfaces.

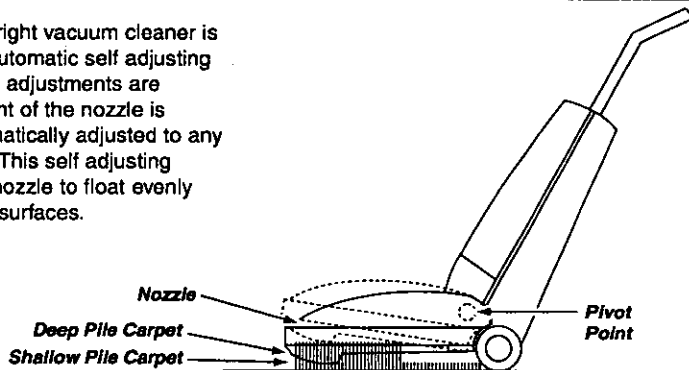

EDGE CLEANING FEATURE

The edge cleaning feature provides for improved cleaning of carpets near walls and furniture.

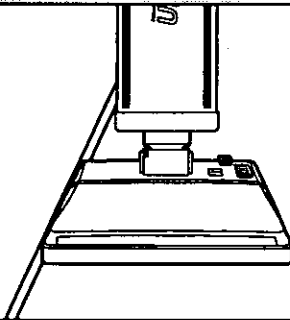

OVERLOAD PROTECTOR

The overload protector protects the motor from brush jamming and belt breakage. If the brush stops, the overload protector will stop the cleaner.

To correct problem: Unplug electrical cord. Check brush area for excessive lint build-up or jamming.

To reset: Press reset button on top of the nozzle. Plug in and turn on cleaner.

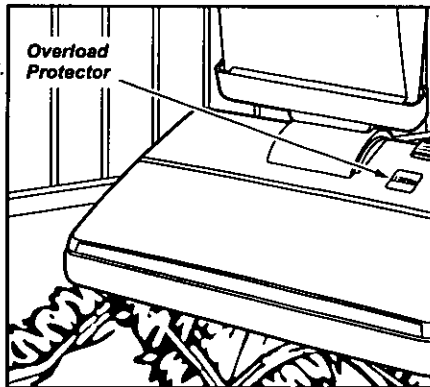

TO OPERATE CLEANER



CAUTION

DO NOT use outlets above counters. Damage to items in the surrounding areas could occur. Care should be taken when plugging the vacuum in as the ON/OFF switch may be ON.

USING THE POWER CORD

The power cord needs to be placed on the cord hooks when not in use.

1. There is a recessed area between the cord hook base and the handle that is designed to secure the power cord during vacuuming.

Always push the power cord down into this recessed area to help keep the power cord from hanging near the nozzle and being damaged by the agitator.

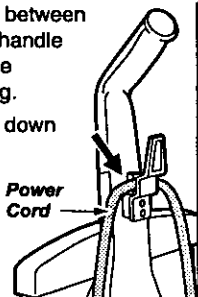

2. Loosely wrap the power cord around the cord hook. Secure the plug head to the cord by pushing the power cord into the retainer on the plug head. Place the cord wrap around the center of the cord.

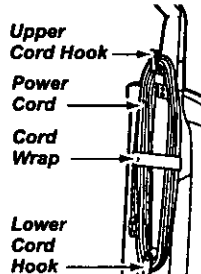

ON/OFF SWITCH

1. Plug the power cord into a 120V outlet.
2. To start the vacuum cleaner, depress the ON/OFF switch. To stop the vacuum cleaner, depress the ON/OFF switch a second time.

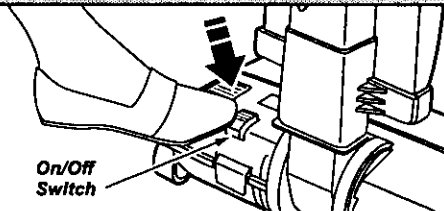

HANDLE ADJUSTMENTS

The handle may be lowered to any position required. Just step on the handle release pedal as indicated by the illustration and lower the handle as desired.

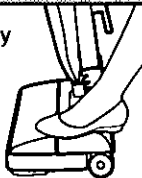

1. Upright position

The handle locks in this position for storage.

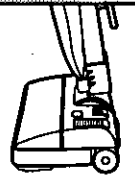

2. Middle position

This position is for normal cleaning.

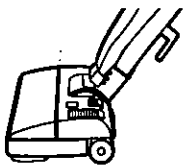

3. Low position

This position is used for cleaning under furniture.

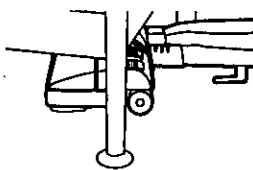

ROUTINE CARE OF CLEANER

Performing the following tasks will keep your new Panasonic vacuum cleaner operating at peak performance levels and will ensure these high levels for years to come. Check the BEFORE REQUESTING SERVICE section in this manual for recommendations on performing some of these tasks to help solve various problems that may occur.



WARNING *Electrical Shock or Personal Injury Hazard.*

Always disconnect electrical supply before performing any service and/or cleaning of the vacuum cleaner. Failure to do so could result in electrical shock or personal injury from cleaner suddenly starting.

CHANGING THE DUST BAG

Always operate the vacuum with a genuine Panasonic Type U9 Electrostatic dust bag installed. Panasonic dust bags may be ordered through any authorized Panasonic dealer.

1. Completely unzip the bag cover.

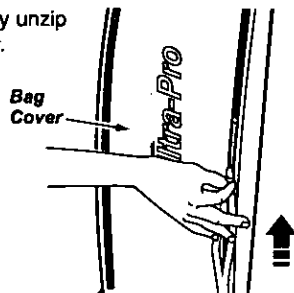

2. To remove the dust bag, grasp the cardboard portion of the dust bag and pull it out.

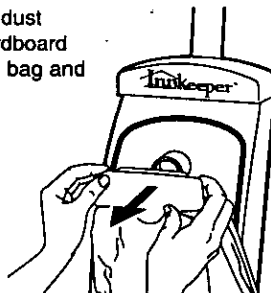

3. Spread out the end of the new dust bag.

NOTE: Pull carefully so as not to tear the bag at the folds.

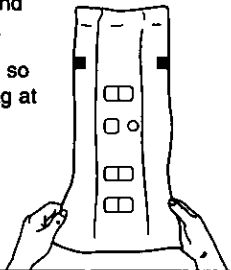

4. Attach the new dust bag onto the bag holder by holding the cardboard portion and pushing back as illustrated.



5. Be sure the dust bag is completely inside the bag cover.

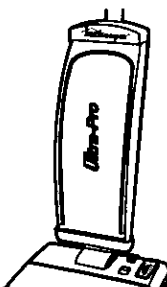

6. Zip the bag cover completely closed to assure proper operation.

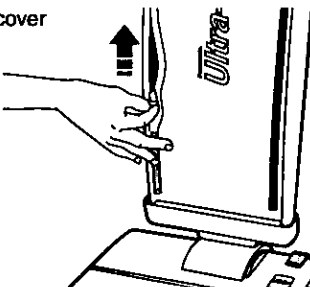



WARNING *Electric Shock or Personal Injury Hazard.*

Disconnect electrical supply before servicing or cleaning the unit. Failure to do so could result in electrical shock or personal injury from cleaner suddenly starting.

REMOVING/INSTALLING THE NOZZLE COVER

Before replacing any parts, disconnect the vacuum cleaner from the electrical outlet.

Replacing some of the parts in this section involves the removal and installation of the nozzle cover. Always place paper under nozzle anytime the nozzle cover is removed to protect the floor surface.

To Remove Nozzle Cover.

Start by placing the handle in the low position. See the HANDLE ADJUSTMENTS section. Remove the front cover by grasping the sides near the front and lifting up. Remove the screw that secures the nozzle cover to the nozzle base. Lift the rear nozzle cover tabs. Tilt the nozzle cover forward until it snaps free. Remove any residue that may exist in the belt area.

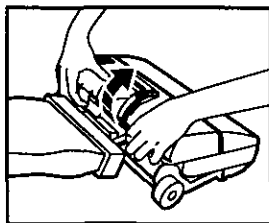
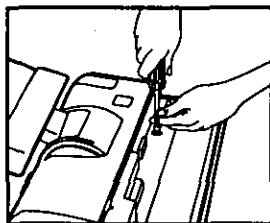
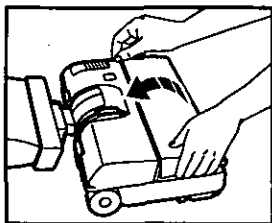

To Reinstall Nozzle Cover.

Line up the front of the nozzle cover under the front edge of the nozzle base as shown. Rotate the nozzle cover down and press firmly until the rear nozzle cover tabs snap into place. Replace the screw that secures the nozzle cover to the nozzle base. Replace the front cover by engaging the rear tabs in the slots and rotate the front cover down until it snaps into place.

NOTE: To ensure maximum cleaning efficiency, the belt should be checked regularly to make sure it is in good condition. Check to see if the belt is stretched, cracked, or if excessive slippage has occurred. Replace if necessary.

REPLACING THE BELT



WARNING *Personal Injury Hazard.*

Be careful when removing agitator. The belt tension is high. Failure to do so could result in personal injury from agitator releasing quickly and snapping away.

Disconnect the vacuum cleaner from the electrical outlet. Remove the nozzle cover as described in the REMOVING/ INSTALLING THE NOZZLE COVER section.

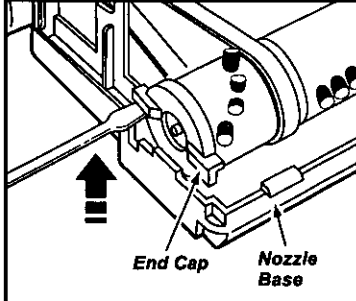

Carefully insert and lift screwdriver at each end cap to free agitator assembly from the nozzle base.

NOTE: The two end caps may come off along with the two washers as you lift the agitator out. **DO NOT** lose the two small washers.

Loop the new belt around the motor shaft and the belt pulley on the agitator. See illustration for correct belt routing. **Use only a Panasonic Type UB9 drive belt.**

Before reinserting the agitator make sure the end caps/washers are on correctly. See illustration in the REPLACING THE AGITATOR section.

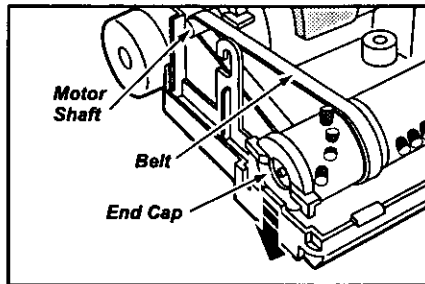
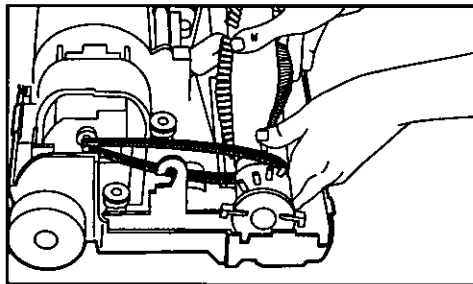

After checking the end caps, reinstall the agitator back into the nozzle base grooves. Be sure the end caps are not upside down. After installing the agitator, turn it by hand making sure that the belt is not twisted or pinched and all rotating parts turn freely. Replace the nozzle cover as described in the REMOVING/INSTALLING THE NOZZLE COVER section.

CLEANING THE AGITATOR

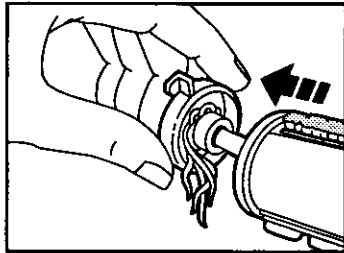

Switch off the vacuum cleaner and unplug the power cord before cleaning the agitator. In order to keep the cleaning efficiency high, clean the agitator and end caps regularly. Remove the end caps to clean. See the REPLACING THE BELT section for the proper procedure.

Agitator and end caps - Cut off any carpet pile and lint entangled around the agitator and end caps with a pair of scissors.

REPLACING THE AGITATOR

1. When to replace the agitator.

The agitator should be replaced when the brushes are worn. Brushes should be checked by holding a card across the lower plate, see illustration. If the bristles on the agitator **DO NOT** touch the card, you **SHOULD** replace the agitator for best cleaning results.

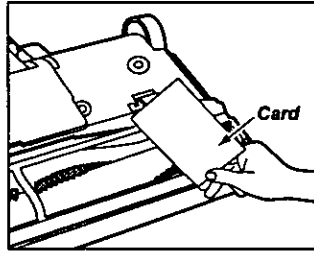

2. How to replace the agitator.

Place the vacuum cleaner handle in the low position. See the **HANDLE ADJUSTMENTS** section. Remove the nozzle cover as outlined in the **REMOVING/INSTALLING THE NOZZLE COVER** section. After the nozzle cover is removed, carefully lift up the agitator until it clears both sides of the nozzle housing. While holding the agitator up, remove the belt.

NOTE: The two end caps may come off along with the two washers as you lift the agitator out. **DO NOT** lose the two small washers. Look at the exploded view of the agitator below for correct assembly of the parts.

3. To replace the agitator.

Place the belt over the belt pulley on the agitator unit. **NOTE:** There is a place for the belt to fit on one end of the agitator only. Replace both washers and end caps, see illustration below for correct assembly. After assembling the belt, washers and end caps place the agitator back into the nozzle housing by aligning each end cap.

After completing the assembly, rotate the brush, turning it by hand to assure that it rotates smoothly and the part is assembled correctly.

Replace the nozzle cover as outlined in the **REMOVING/INSTALLING THE NOZZLE COVER** section.

AGITATOR ASSEMBLY

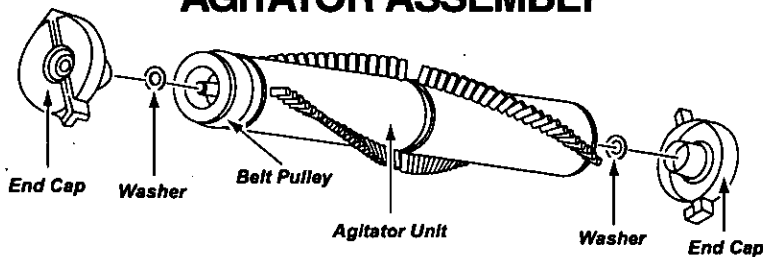

CLEANING EXTERIOR

1. Unplug cord from wall outlet. **DO NOT drip water on cleaner.**
2. Clean exterior using a clean, soft cloth that has been dipped in a solution of mild liquid detergent and water and wrung dry. Wipe dry after cleaning.
3. To reduce static electricity and dust build-up, wipe outer surface of cleaner.

REMOVING CLOGS

For best cleaning results, keep the airflow passage clear.

1. Unplug the power cord from the outlet before checking the airflow passages. Check each starred area occasionally for clogs.

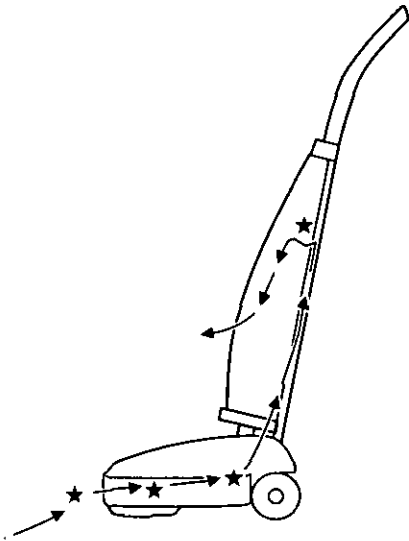

2. Remove the dust bag and visually inspect the opening to the dirt tube for any clogging. For details see the **CHANGING THE DUST BAG** section.

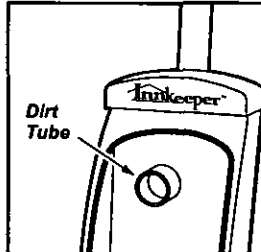

3. Remove the nozzle cover and check for clogs. See the **REMOVING/ INSTALLING THE NOZZLE COVER** section for detailed instructions.

NOTE: If clogging has occurred between the nozzle area and the dirt tube opening, do not attempt to service. Take the vacuum to the nearest authorized Panasonic Servicenter.

BEFORE REQUESTING SERVICE



WARNING *Electric Shock or Personal Injury Hazard.*

Disconnect the electrical supply before servicing or cleaning the unit. Failure to do so could result in electric shock or personal injury from cleaner suddenly starting.

Review this chart to find do-it-yourself solutions for minor performance problems. Any service needed, other than those described in these Operating Instructions, should be performed by an authorized service representative.

PROBLEM	POSSIBLE CAUSE	POSSIBLE SOLUTION
Cleaner will not run.	<ol style="list-style-type: none"> 1. Unplugged at wall outlet. 2. On/Off switch not turned on. 3. Tripped circuit breaker/blown fuse at household service panel. 4. Tripped overload protector. 	<ol style="list-style-type: none"> 1. Plug in firmly. Push On/Off switch to On. 2. Push On/Off switch to On. 3. Reset circuit breaker or replace fuse. 4. Remove any items that may be caught or jammed, then reset. If cleaner starts and stops again, clean brush and end caps, then reset.
Poor job of dirt pickup.	<ol style="list-style-type: none"> 1. Full or clogged dust bag. 2. Worn agitator. 3. Clogged nozzle. 4. Clogged dirt tube. 5. Broken belt. 	<ol style="list-style-type: none"> 1. Change bag. 2. Replace agitator. 3. Clean nozzle area. 4. Clean dirt tube. 5. Replace belt.
Dust escapes the paper bag.	<ol style="list-style-type: none"> 1. Bag improperly installed. 2. Bag torn. 3. Bag cover improperly installed. 	<ol style="list-style-type: none"> 1. Properly install bag. 2. Replace bag. 3. Check instructions.

WARRANTY

Panasonic Commercial Vacuum Cleaner Limited Warranty

Panasonic Home and Commercial Products Company (referred to as "the warrantor") will repair this product with new or refurbished parts free of charge, in the U.S.A. or Puerto Rico, for six (6) months from the date of original purchase, in the event of a defect in materials or workmanship.

This Limited Warranty Excludes both Labor and Parts for the following items: disposable dust bags, filters, belts, light bulbs, agitator brushes and batteries (if supplied).

Carry-in or mail-in service in the U.S.A. can be obtained during the warranty period by contacting a Panasonic Services Company (PASC) Factory Servicenter listed in the Servicenter Directory, or by calling toll free, 1-888-350-9590, or by contacting your selling distributor. Carry-in or mail-in service in Puerto Rico can be obtained during the warranty period by calling the local Panasonic Sales Company telephone number listed in the Servicenter Directory.

This warranty is extended only to the original purchaser. A purchase receipt or other proof of date of original purchase will be required before warranty performance is rendered.

This warranty only covers failures due to defects in materials and workmanship which occur during normal use and does not cover damages which occur in shipment, or failures which are caused by products not supplied by the warrantor, or failures which result from accident, misuse, abuse, neglect, mishandling, misapplication, faulty installation, improper operation or maintenance, alteration, modification, power line surge, improper voltage supply, lightning damage, or service by anyone other than a Panasonic Authorized Servicenter, or damage that is attributable to acts of God.

LIMITS AND EXCLUSIONS:

There are no express warranties except as listed above.

THE WARRANTOR SHALL NOT BE LIABLE FOR INCIDENTAL OR CONSEQUENTIAL DAMAGES RESULTING FROM THE USE OF THIS PRODUCT, OR ARISING OUT OF ANY BREACH OF THIS WARRANTY. ALL EXPRESS AND IMPLIED WARRANTIES, INCLUDING THE WARRANTIES OF MERCHANTABILITY AND FITNESS FOR A PARTICULAR PURPOSE, ARE LIMITED TO THE APPLICABLE WARRANTY PERIOD SET FORTH ABOVE.

Some states do not allow the exclusion or limitation of incidental or consequential damages, or limitations on how long an implied warranty lasts, so the above exclusions or limitations may not apply to you.

This warranty gives you specific legal rights and you may also have other rights which vary from state to state. If a problem with this product develops during or after the warranty period, you may contact your dealer or Servicenter. If the problem is not handled to your satisfaction, then write to the Customer Satisfaction Center at the listed address on the back cover.

WHAT TO DO WHEN SERVICE IS NEEDED

If your Panasonic Vacuum Cleaner needs service, look in the yellow pages of the telephone book under HOME APPLIANCE SERVICE for your nearest Panasonic Services Company ("PASC") Factory Servicenter, or PASC authorized Servicenter, or call 1-888-350-9590, toll free to find a convenient servicenter. **DO NOT** send the product to the Executive or Regional Sales offices. They are **NOT** equipped to make repairs.

If you ship the product

Carefully pack and send it prepaid, adequately insured and preferably in the original carton. Attach a postage-paid letter to the outside of the carton, which contains a description of your complaint. **DO NOT send the product to the Executive or Regional Sales Offices. They are NOT equipped to make repairs.**

Customer's Record

Model No. _____ Dealer's Name _____

Serial No. _____

Dealer's Address _____

Date of Purchase _____

Consumers requiring product information or operating assistance with a consumer product should contact:

**CUSTOMER SATISFACTION
CENTER
DEPARTMENT 2F-3
1-888-350-9590**

**DIAL TOLL FREE
1-888-350-9590**

Panasonic Services Co.

**24 hours a day,
7 days a week**

PANASONIC HOME & COMMERCIAL PRODUCTS
COMPANY, DIVISION OF MATSUSHITA ELECTRIC
CORPORATION OF AMERICA

The Panasonic Way
A-4
Fairfield, New Jersey 07094

©1988 Panasonic Company
P01ZAPM10U
P01ZAPM10U00

Printed in U.S.A.