

Panasonic®

VACUUM CLEANER

Aspirateur

Aspiradora

MC-V5209

Operating Instructions

Manuel d'utilisation

Instrucciones de operación

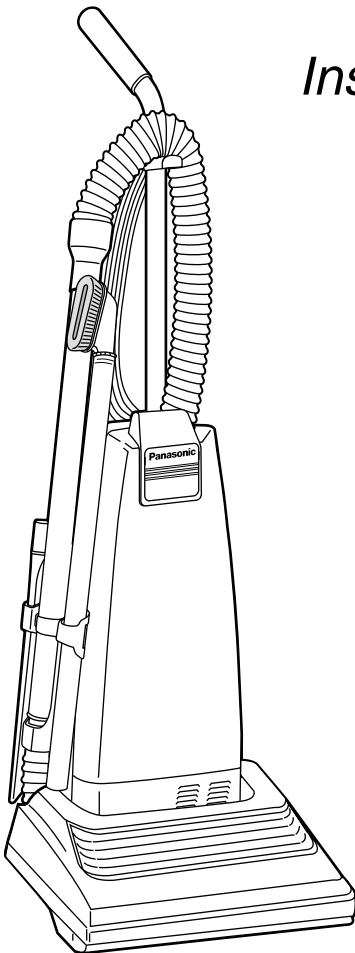

QUICKDRAW™
TOOLS-ON-BOARD WITH READY-TO-USE HOSE

Before operating your vacuum cleaner, please read these instructions completely.

Avant d'utiliser l'appareil, il est recommandé de lire attentivement ce manuel.

Antes de usar su aspiradora, lea completamente estas instrucciones por favor.

CONSUMER INFORMATION

Please read **IMPORTANT SAFETY INSTRUCTIONS** on page 5 before use. Read and understand all instructions.

TO OUR VALUED CUSTOMER

We are very pleased to welcome you to the Panasonic family of products. Thank you for purchasing this product. Our intent is that you become one of our many satisfied customers.

Proper assembly and safe use of your vacuum cleaner are your responsibilities. Your vacuum cleaner is intended for commercial use. The cleaner should be stored in a dry, indoor area. Read the Operating Instructions carefully for important use and safety information.

Special care is required when vacuuming certain types of carpet or floor covering. Always check the carpet or floor covering manufacturer's recommended cleaning instructions before vacuuming.

PLEASE PAY CLOSE ATTENTION TO ALL WARNING AND CAUTION STATEMENTS.

WARNING

WARNING statements are designed to alert you to the possibility of personal injury, loss of human life, and/or damage to the vacuum cleaner and/or personal property if the instructions given are not followed.

CAUTION

CAUTION statements are designed to alert you to the possibility of damage to the vacuum cleaner and/or personal property if the instructions given are not followed.

WARNING

TO AVOID ELECTRICAL SHOCK

Never vacuum damp or wet surfaces or liquids.
DO NOT store machine outdoors.
Replace worn or frayed power cord immediately.
Unplug from outlet when not in use and before servicing.

TO AVOID ACCIDENTS

Except for hand-held cleaners, keep machine on floor - not chairs, tables, steps, stairs, etc.
Store machine promptly after each use to prevent accidents such as tripping over power cord or machine.
Use machine and accessories only in a manner intended by the manufacturer.
The use of an extension cord is not recommended.

IMPORTANT SAFETY INSTRUCTIONS

When using vacuum cleaner, basic precautions should always be followed, including the following:

READ ALL INSTRUCTIONS BEFORE USING THIS VACUUM CLEANER

WARNING

To reduce the risk of fire, electrical shock, injury:

1. **DO NOT** leave vacuum cleaner when plugged in. Unplug from outlet when not in use and before servicing.
2. To reduce the risk of fire, electric shock - **DO NOT** use outdoors or on wet surfaces.
3. **DO NOT** allow to be used as a toy. Close attention is necessary when used by or near children.
4. Use only as described in this manual. Use only manufacturer's recommended tools.
5. **DO NOT** use with damaged cord or plug. If vacuum cleaner is not working as it should, has been dropped, damaged, left outdoors, or dropped into water, return it to an authorized Panasonic Servicenter.
6. **DO NOT** pull or carry by cord, use cord as a handle, close door on cord, or pull cord around sharp edges or corners. **DO NOT** run vacuum cleaner over cord. Keep cord away from heated surfaces.
7. **DO NOT** unplug by pulling on cord. To unplug, grasp the plug, not the cord.
8. **DO NOT** handle plug or vacuum cleaner with wet hands.
9. **DO NOT** put any objects into openings. **DO NOT** use with any opening blocked; keep free of dust, lint, hair, and anything that may reduce air flow.
10. Keep hair, loose clothing, fingers, and all parts of body away from openings and moving parts.
11. **DO NOT** pick up anything that is burning or smoking, such as cigarettes, matches, or hot ashes.
12. **DO NOT** use without dust bag and/or filters in place.
13. Turn off all controls before unplugging.
14. Use extra care when cleaning on stairs.
15. **DO NOT** use cleaner to pick up flammable or combustible liquids such as gasoline or use in areas where they may be present.
16. **DO NOT** operate cleaner without belt cover properly installed.

SAVE THESE INSTRUCTIONS

THIS VACUUM CLEANER IS INTENDED FOR HOUSEHOLD USE ONLY

Note: Before you plug in your Panasonic vacuum cleaner, make sure that the voltage indicated on the rating plate located at the back of the vacuum cleaner is the same as your local supply.

TABLE OF CONTENTS

CONSUMER INFORMATION	2
IMPORTANT SAFETY INSTRUCTIONS	5
PARTS IDENTIFICATION	10
FEATURE CHART	11
ASSEMBLY	12
Attaching Handle	12
FEATURES	14
Using Cord Hook	14
Tool Storage	14
Edge Cleaning	16
Motor Protector	16
Automatic Self Adjusting Nozzle	16
TO OPERATE CLEANER	18
Power Cord	18
ON-OFF Switch	18
Handle Adjustments	20
Using Tools	22
ROUTINE CARE OF CLEANER	24
Replacing Secondary HEPA Filter	24
Changing Dust Bag	24, 26
Removing and Installing Lower Plate	28
Replacing Headlight Bulb	30
Replacing Belt	32
Cleaning Agitator	32
Replacing Brushes	34
Agitator Assembly	36
Removing Clogs	36
Cleaning Exterior and Tools	38
BEFORE REQUESTING SERVICE	41
WARRANTY	43,44
WHAT TO DO WHEN SERVICE IS NEEDED	48

PARTS IDENTIFICATION

Nomenclature Identificación de piezas

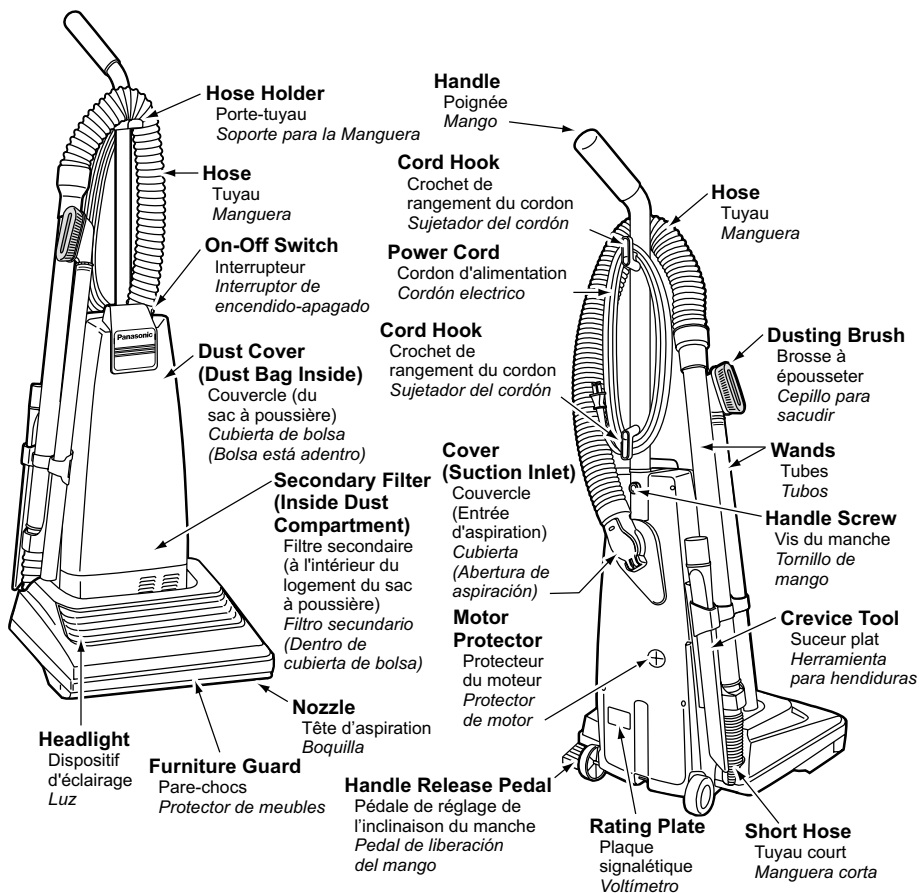

FEATURE CHART

Power	Motor Protector	Cord Length	Tools
120V AC(60Hz)	Yes	7.6 m (25 Ft.)	Yes

Tableau des caractéristiques

Alimentation	Protecteur du moteur	Longueur du cordon	Accessoires
12.0 A (12,0 A)	Oui	7,6 m (25 pi)	Oui

Diagrama de características

<i>Voltaje</i>	<i>Protector de motor</i>	<i>Extensión de cordón</i>	<i>Herramientas</i>
12.0 A (12,0 A)	<i>Sí</i>	7,6 m (25 pi)	<i>Sí</i>

ASSEMBLY

Attaching Handle

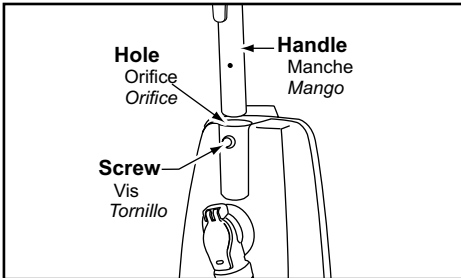

- 1)
 - **DO NOT** plug in until assembly is complete.
 - Remove handle screw.
 - Insert handle with cord hooks to the back of the cleaner.

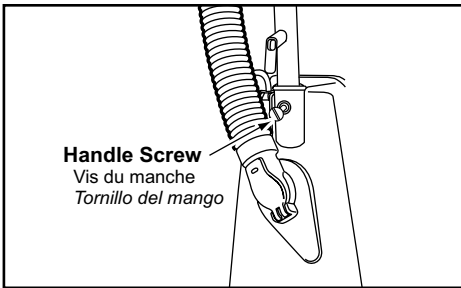

- 2)
 - Insert screw.
 - Tighten screw.

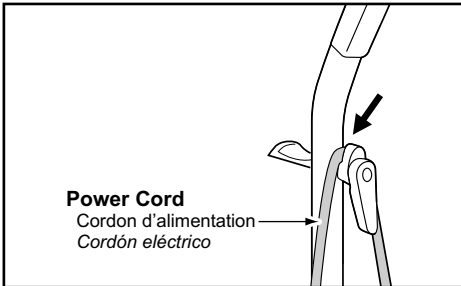

- 3)
 - Push power cord into cord clip.

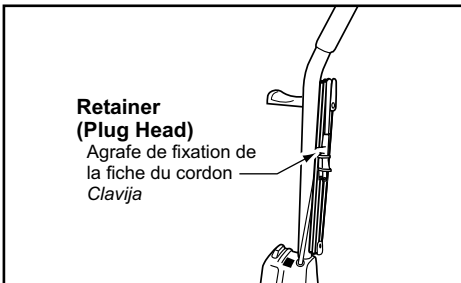

- 4)
 - Wrap power cord around cord hooks.
 - Secure retainer (plug head) to power cord.

FEATURE

Using Cord Hook

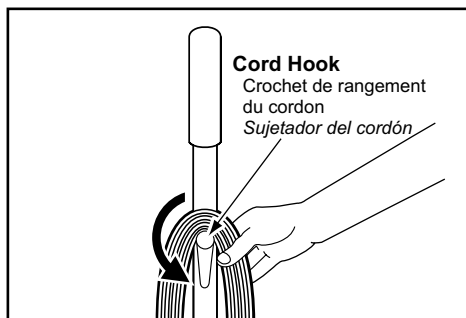

- 1)
 - Detach plug head from power cord.
 - Rotate cord hook down to release cord.

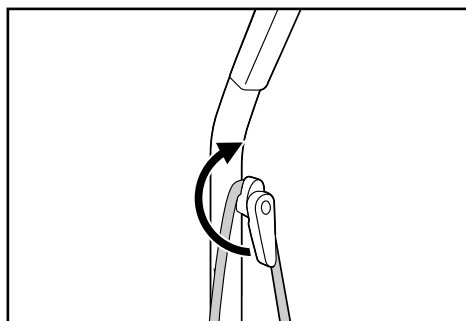

- 2)
 - Return the cord hook to the upright position before attempting to rewind the cord.

Tool Storage

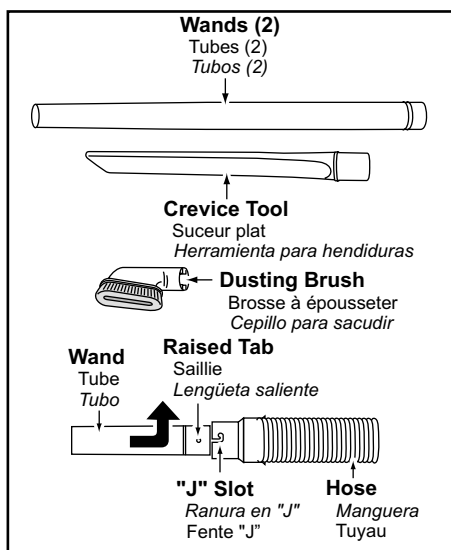

- Some tools may already be stored on vacuum cleaner.
- Place hose in front of handle on hose holder.
- Attach wand to hose by aligning the two (2) raised tabs on wand with "J" slots in hose, guide tabs along grooves, twist to lock in place.
- Place wand in center slot of tool holder, twisting and pushing down over short hose to assure a good connection.
- Store other wand in front slot of tool holder with dusting brush in top of wand.
- Place crevice tool into rectangular rear slot of tool holder.
- Refer to PARTS IDENTIFICATION section for tool location.

Edge Cleaning

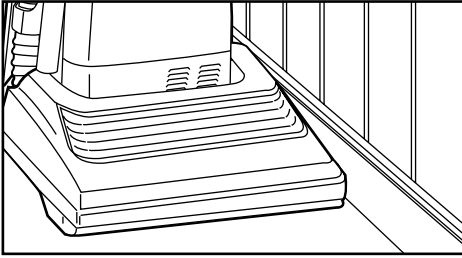

- Edge cleaning feature provides for improved cleaning of carpets near walls and furniture.

Motor Protector

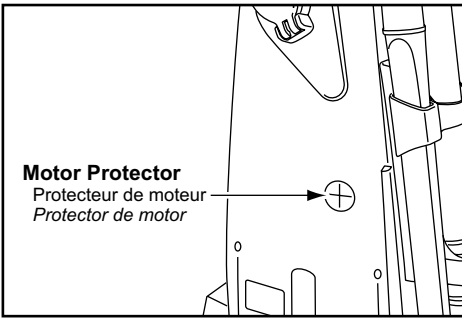

- Automatically opens to provide cooling air to the motor when a clog occurs or when dust bag needs changing.
- Motor protector may open when using tools.
- If motor protector opens, the vacuum will make a slightly different sound.

Note: Do not block motor protector.

Automatic Self Adjusting Nozzle

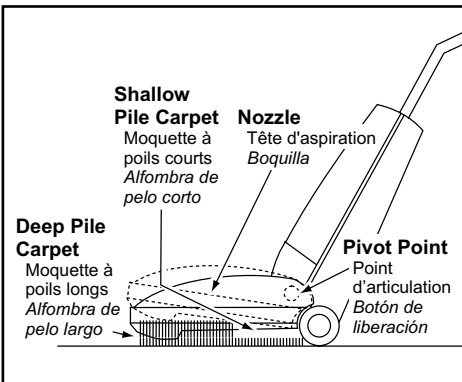

- The nozzle of your Panasonic upright vacuum cleaner automatically adjusts to any carpet pile height.
- Feature allows nozzle to float evenly over carpet pile surfaces.
- No manual adjustments required.

TO OPERATE CLEANER

Power Cord

NOTE: To reduce the risk of electrical shock, this vacuum has a polarized plug, one blade is wider than the other. This plug will fit in a polarized outlet only one way. If the plug does not fit fully in the outlet, reverse the plug. If it still does not fit, contact a qualified electrician to install the proper outlet. **DO NOT CHANGE THE PLUG IN ANY WAY.** Only use outlets near the floor.

ON-OFF Switch

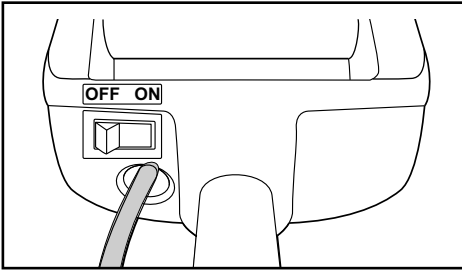

- Ensure ON-OFF switch is OFF.
- Plug the power cord into 120V outlet.
- ON position turns vacuum on.
- OFF position turns vacuum off.

Handle Adjustments

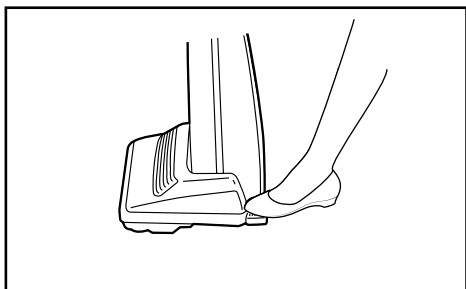

1)

- Step on handle release pedal to change handle position.

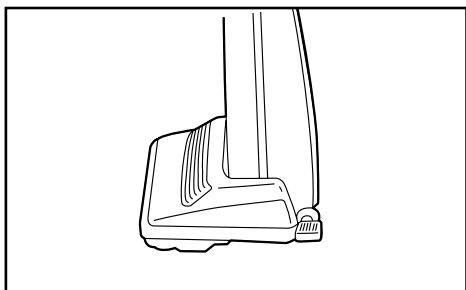

2)

- Move vacuum to upright position for storage and tool use.

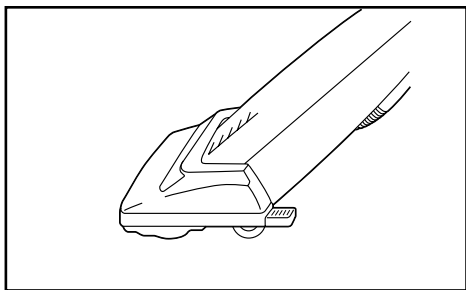

3)

- Move vacuum to middle position for normal use.

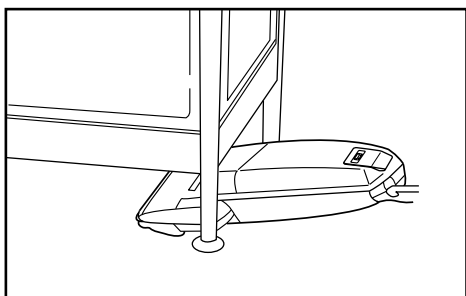

4)

- Use low position for cleaning under furniture.

Using Tools

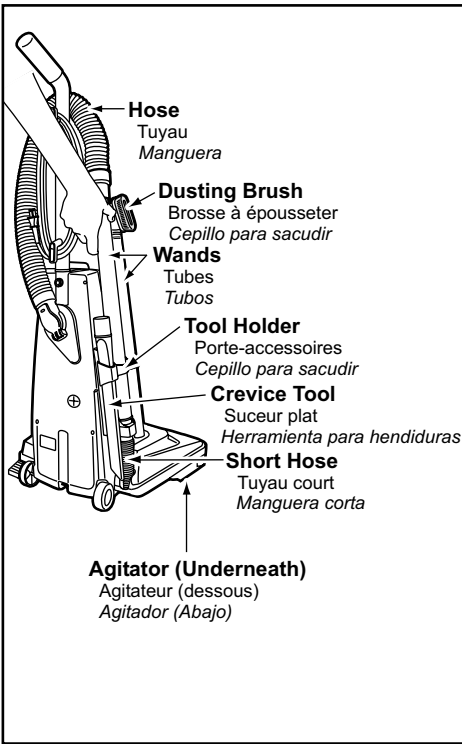

- Agitator rotates when using tools, use care to ensure that nothing comes into contact with agitator.
- Remove wand from short hose by twisting and pulling up.
- The tools can be attached to hose, wand or crevice tool.
- **DO NOT** overextend your reach with hose as it could tip vacuum.
- Place all tools and hose back in the same manner as shown in **TOOL STORAGE**.

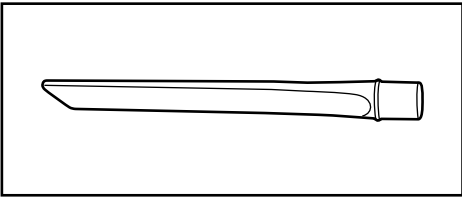

- The Crevice Tool may be used on the following items:
 - Furniture
 - Cushions
 - Drapes
 - Stairs
 - Walls

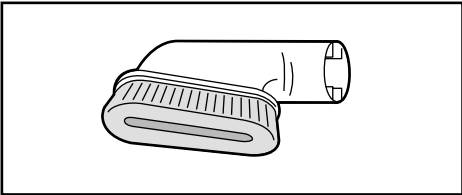

- The Dusting Brush may be used on the following items:
 - Furniture
 - Drapes
 - Stairs
 - Walls

ROUTINE CARE OF CLEANER

Performing the following tasks will keep your new Panasonic vacuum cleaner operating at peak performance levels and will ensure these high levels for years to come. Check the **BEFORE REQUESTING SERVICE** section in this manual for recommendations on performing some of these tasks to help solve various problems that may occur.

Replacing Secondary HEPA Filter

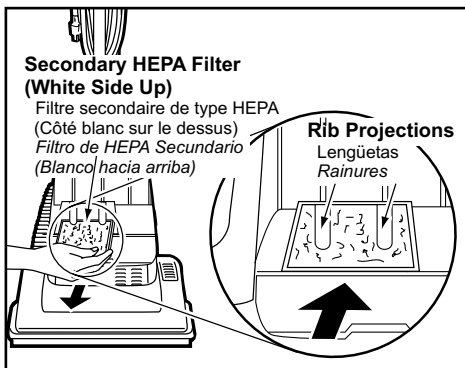

- Secondary HEPA filter protects the motor.
- Check filter when installing a new dust bag.
- If dirty, pull filter from bottom of dust compartment and replace.
- Place new filter, white side up, in dust compartment, **DO NOT CLEAN WITH WATER***.
- Ensure filter is fully inserted under plastic rib projections.

*Filter cannot be cleaned and should be replaced at least once each year.

Changing Dust Bag

Always operate vacuum with genuine Panasonic Type U3 Standard or U6 Electrostatic dust bags installed. Panasonic dust bags may be purchased through any authorized Panasonic dealer or ordered from service company.

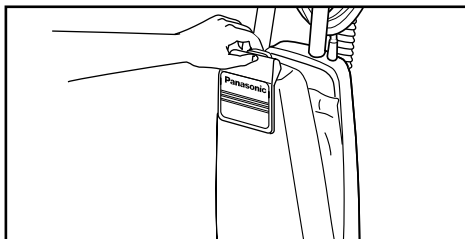

- Pull outward on dust cover grip to remove the dust cover.

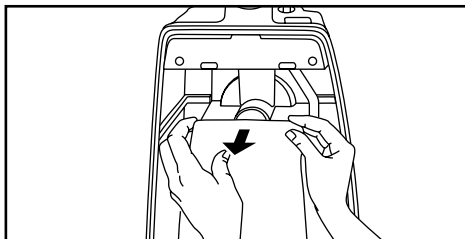

- Remove dust bag by grasping cardboard portion and pulling out.

Changing Dust Bag

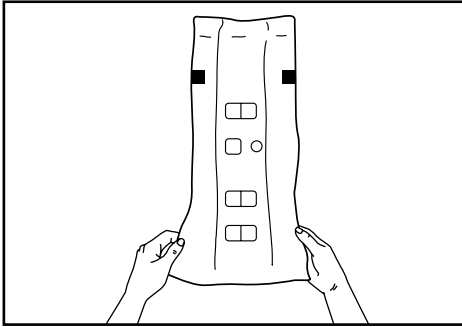

3)

- Spread out new dust bag, taking care not to tear bag.

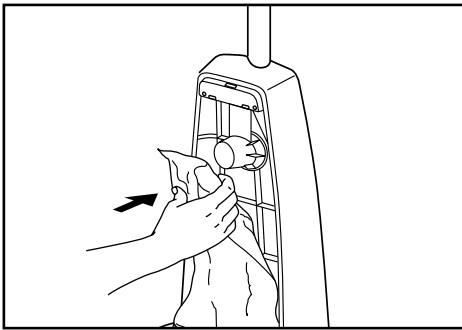

4)

- Attach new dust bag onto bag holder by holding cardboard portion and pushing back.

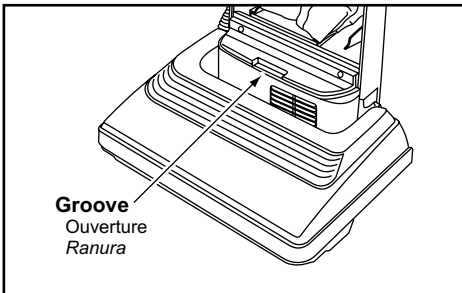

5)

- Reinsert tab on end of dust cover into groove on dust compartment to allow cover to rotate closed.

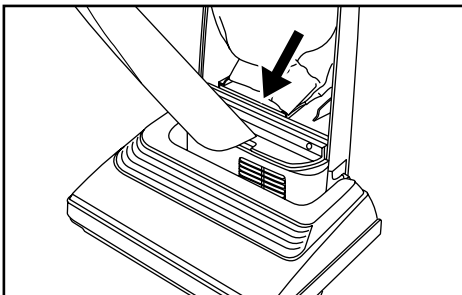

6)

- Rotate dust cover up into closed position and press into place without pinching dust bag.

! **WARNING** Electrical Shock or Personal Injury Hazard

Disconnect the electrical supply before servicing or cleaning the unit. Failure to do so could result in electrical shock or personal injury from cleaner suddenly starting.

Removing and Installing Lower Plate

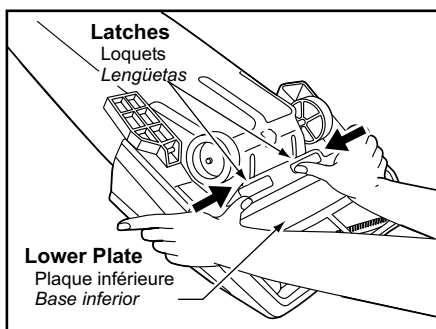

- **Before servicing any parts, disconnect vacuum from electrical outlet.**
- **Place paper under nozzle anytime lower plate is removed to protect floor.**
- **Place handle in upright position and turn vacuum over to expose lower plate.**
- **Release lower plate by pressing two (2) latches inward.**
- **Remove lower plate and remove any residue that may exist in belt area.**
- **Reinstall lower plate by hooking front end of lower plate into slots on front of nozzle housing.**
- **Make sure all wires are routed properly and not pinched.**
- **Press lower plate into place then push two (2) latches outward.**

Replacing Headlight Bulb

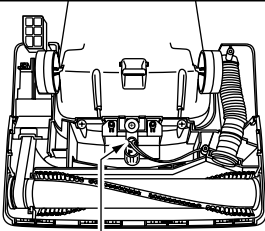

Bulb Socket Assembly

Assemblage de la lampe
Casquillo portalámparas

- Remove lower plate.
- Remove bulb socket screw, grasp the bulb socket assembly and pull upward while moving it back and forth.
- Remove old bulb from the bulb socket assembly by pushing in while turning counter-clockwise.
- Replace bulb by pushing in while turning clockwise.
- Only use a bulb rated 130 V AC-15 Watts or less.
- Replace bulb socket assembly into nozzle housing by pushing it back down into slot and reinstall bulb socket screw.
- Reinstall lower plate.

Replacing Belt

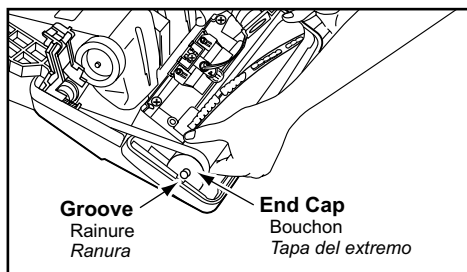
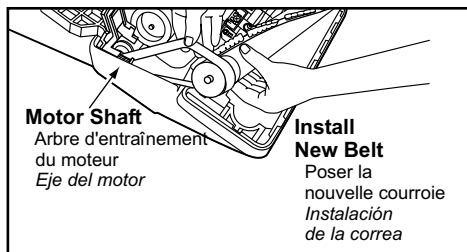
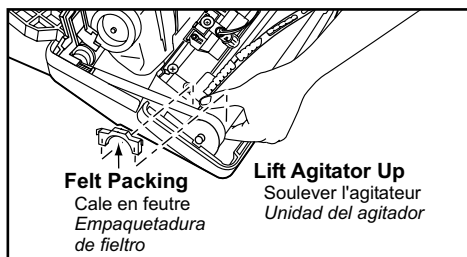

- Replace belt whenever a burning rubber smell caused by excessive slippage occurs.
- Remove lower plate.
- Lift rear belt cover and remove felt packing.
- Remove agitator by carefully lifting out.
- Remove worn or broken belt.
- Clean agitator.
- Loop new belt (Panasonic Type UB8 only) around motor shaft and agitator pulley; see illustration for correct belt routing.
- Reinstall agitator back into nozzle housing grooves.
- Close rear belt cover and reinstall felt packing.
- After reinstalling the agitator, turn it by hand to make sure that belt is not twisted or pinched and that all rotating parts turn freely.
- Reinstall lower plate.

Cleaning Agitator

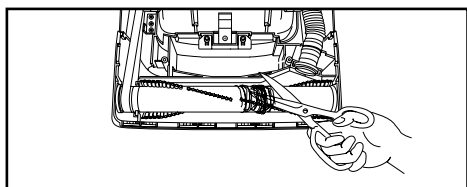

- Clean agitator after every five uses and every time the belt is replaced.
- Remove lower plate.
- Cut off any carpet pile and lint entangled around agitator with a pair of scissors.
- Remove agitator.
- Remove any string or debris located on the end caps, washers or agitator shaft.
- Reinstall agitator and lower plate.

Replacing Brushes

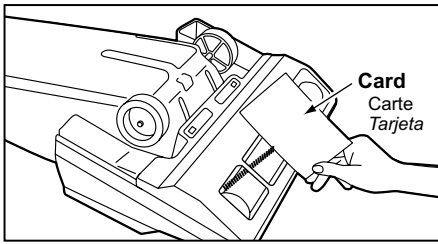

➤ When the bristles on the agitator are worn so that they do not touch a card held across the lower plate, the brushes should be replaced.

➤ Remove lower plate and agitator.

➤ Remove the E-clip from agitator shaft and end cap.

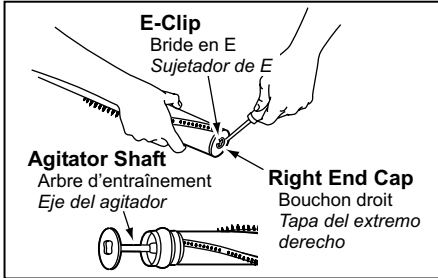

➤ Do not bend agitator shaft or lose E-clip.

➤ Pull agitator shaft out of agitator body.

➤ Pull, or pry out, agitator holder and agitator pulley.

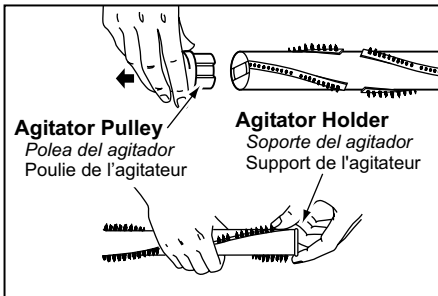

➤ Push each brush out of agitator body as shown.

➤ Install new brushes by reversing procedure.

➤ Reinstall agitator holder and agitator pulley completely.

➤ Reinstall the agitator shaft, end cap and E-clip.

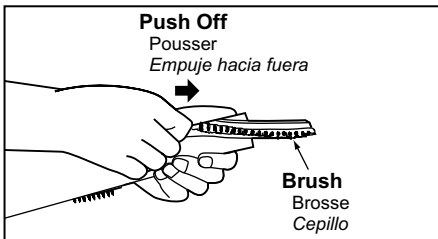

➤ See AGITATOR ASSEMBLY for correct assembly of parts.

➤ Position belt over agitator pulley on the agitator.

➤ Reinstall agitator and lower plate.

Agitator Assembly

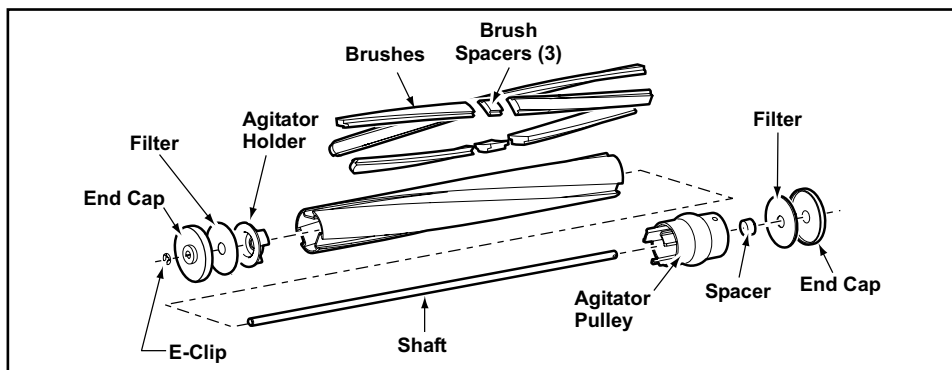

Removing Clogs

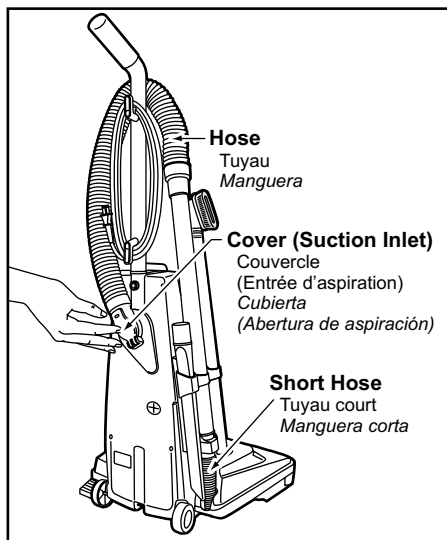

The hose located on the back of the vacuum cleaner carries the dirt from the nozzle up to the dust bag. If the hose should become clogged:

- Unplug vacuum.
- Pull open suction inlet cover and check for clogging.
- Disconnect wand from short hose and check wand and hose.
- Plug in vacuum cleaner and turn on.
- Disconnect wand and stretch hose in and out to remove clog.
- If clog still exists, turn vacuum cleaner OFF and **UNPLUG POWER CORD.**
- Remove lower plate.
- Remove short hose from nozzle by lifting straight up.
- Inspect hose end and clear any obstructions.
- Reinstall short hose and lower plate.

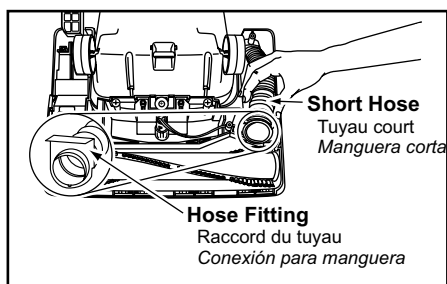

Cleaning Exterior and Tools

- Unplug cord from wall outlet.
- Clean exterior using a clean, soft cloth that has been dipped in a solution of mild liquid detergent and water and wrung dry.
- DO NOT drip water on cleaner, wipe dry after cleaning.
- DO NOT clean tools in dishwasher or clothes washer.
- Wash tools in warm soapy water, rinse and air dry.
- DO NOT use tools if they are wet.

BEFORE REQUESTING SERVICE



WARNING Electrical Shock or Personal Injury Hazard

Disconnect the electrical supply before servicing or cleaning the unit. Failure to do so could result in electrical shock or personal injury from cleaner suddenly starting.

Review this chart to find do-it-yourself solutions for minor performance problems. Any service needed, other than those described in these Operating Instructions, should be performed by an authorized service representative.

PROBLEM	POSSIBLE CAUSE	POSSIBLE SOLUTION
Cleaner will not run.	<ol style="list-style-type: none"> 1. Unplugged at wall outlet. 2. ON-OFF switch not turned on. 3. Tripped circuit breaker/blown fuse at household service panel. 	<ol style="list-style-type: none"> 1. Plug in firmly. Push ON-OFF switch to ON. 2. Push ON-OFF switch to ON. 3. Reset circuit breaker or replace fuse.
Poor job of dirt pickup.	<ol style="list-style-type: none"> 1. Full or clogged dust bag. 2. Broken belt. 3. Clogged hose or nozzle. 4. Hose not inserted fully. 5. Worn agitator. 6. Hole in hose. 7. Dust cover improperly installed. 8. Belt not installed on motor shaft. 	<ol style="list-style-type: none"> 1. Change dust bag. 2. Replace belt. 3. Clean hose or nozzle area. 4. Insert hose. 5. Replace agitator. 6. Replace hose. 7. Properly install dust cover. 8. Install belt on motor shaft.
Dust escapes the paper bag.	<ol style="list-style-type: none"> 1. Bag improperly installed. 2. Bag torn. 	<ol style="list-style-type: none"> 1. Properly install bag. 2. Replace bag.
Light will not work.	<ol style="list-style-type: none"> 1. Burned out light bulb. 	<ol style="list-style-type: none"> 1. Replace light bulb.

WARRANTY

Panasonic Vacuum Cleaner Limited Warranty (United States)

Panasonic Consumer Electronics Company (collectively referred to as "the warrantor") will repair this product with new or refurbished parts free of charge, in the U.S.A. or Puerto Rico for one (1) year from the date of original purchase in the event of a defect in materials or workmanship.

This Limited Warranty Excludes both Labor and Parts for the following items which require normal replacement: Disposable Dust Bag, Filters, Belts, Light Bulbs, Agitator Brushes and Batteries (if supplied).

Carry-in or mail-in service in the U.S.A. can be obtained during the warranty period by contacting a Panasonic Services Company (PASC) Factory Servicenter listed in the Servicenter Directory. Or call, toll free, 1-800-211-PANA (7262) to locate a PASC Authorized Servicenter. Carry-in or mail-in service in Puerto Rico can be obtained during the warranty period by calling the local Panasonic Sales Company telephone number listed in the Servicenter Directory.

This warranty is extended only to the original purchaser. A purchase receipt or other proof of date of original purchase will be required before warranty performance is rendered.

This warranty only covers failures due to defects in materials and workmanship which occur during normal use and does not cover damages which occur in shipment, or failures which are caused by products not supplied by the warrantor, or failures which result from accident, misuse, abuse, neglect, mishandling, misapplication, faulty installation, improper operation or maintenance, alteration, modification, power line surge, improper voltage supply, lightning damage, commercial use such as hotel, office, restaurant or other business or rental use of the product, or service by anyone other than a PASC Authorized Servicenter, or damage that is attributable to acts of God.

LIMITS AND EXCLUSIONS:

There are no express warranties except as listed above.

THE WARRANTOR SHALL NOT BE LIABLE FOR INCIDENTAL OR CONSEQUENTIAL DAMAGES RESULTING FROM THE USE OF THIS PRODUCT, OR ARISING OUT OF ANY BREACH OF THIS WARRANTY. ALL EXPRESS AND IMPLIED WARRANTIES, INCLUDING THE WARRANTIES OF MERCHANTABILITY AND FITNESS FOR A PARTICULAR PURPOSE, ARE LIMITED TO THE APPLICABLE WARRANTY PERIOD SET FORTH ABOVE.

Some states do not allow the exclusion or limitation of incidental or consequential damages, or limitations on how long an implied warranty lasts, so the above exclusions or limitations may not apply to you.

This warranty gives you specific legal rights and you may also have other rights which vary from state to state. If a problem with this product develops during or after the warranty period, you may contact your dealer or Servicenter. If the problem is not handled to your satisfaction, then write to the Consumer Affairs Department at the listed address on the back cover.

WARRANTY

Panasonic Canada Inc.
5770 Ambler Drive, Mississauga, Ontario L4W 2T3

PANASONIC PRODUCT - LIMITED WARRANTY (Canada)

Panasonic Canada Inc. warrants this product to be free from defects in material and workmanship and agrees to remedy any such defect for a period as stated below from the date of original purchase.

Vacuum Cleaner - One (1) year, parts and labour

LIMITATIONS AND EXCLUSIONS

This warranty does not apply to products purchased outside Canada or to any product which has been improperly installed, subjected to usage for which the product was not designed, misused or abused, damaged during shipping, or which has been altered or repaired in any way that affects the reliability or detracts from the performance, nor does it cover any product which is used commercially. Parts such as disposable dust bags, filters, belts, light bulbs and agitator brushes are also excluded from coverage under this warranty.

This warranty is extended to the original end user purchaser only. A purchase receipt or other proof of date of original purchase is required before warranty service is performed.

THIS EXPRESS, LIMITED WARRANTY IS IN LIEU OF ALL OTHER WARRANTIES, EXPRESS OR IMPLIED, INCLUDING ANY IMPLIED WARRANTIES OF MERCHANTABILITY AND FITNESS FOR A PARTICULAR PURPOSE. IN NO EVENT WILL PANASONIC CANADA INC. BE LIABLE FOR ANY SPECIAL, INDIRECT OR CONSEQUENTIAL DAMAGES.

In certain instances, some jurisdictions do not allow the exclusion or limitation of incidental or consequential damages, or the exclusion of implied warranties, so the above limitations and exclusions may not be applicable.

WARRANTY SERVICE

For product operation and information assistance, please contact your Dealer or our Customer Care Centre at:
Telephone #: (905) 624-5505 Fax #: (905) 238-2360 Web: www.panasonic.ca

For product repairs, please contact one of the following:

- Your Dealer who will inform you of an authorized Servicentre nearest you.
- Our Customer Care Centre at (905) 624-5505 or www.panasonic.ca
- A Panasonic Factory Servicentre listed below:

Richmond, British Columbia

Panasonic Canada Inc.
12111 Riverside Way
Richmond, BC V6W 1K8
Tel: (604) 278-4211
Fax: (604) 278-5627

Calgary, Alberta

Panasonic Canada Inc.
6835-8th St. N.E.
Calgary, AB T2E 7H7
Tel: (403) 295-3955
Fax: (403) 274-5493

Mississauga, Ontario

Panasonic Canada Inc.
5770 Ambler Dr.
Mississauga, ON L4W 2T3
Tel: (905) 624-8447
Fax: (905) 238-2418

Lachine, Québec

Panasonic Canada Inc.
3075, rue Louis A. Amos
Lachine, QC H8T 1C4
Tel: (514) 633-8684
Fax: (514) 633-8020

IF YOU SHIP THE PRODUCT TO A SERVICENTRE

Carefully pack and send prepaid, adequately insured and preferably in the original carton.
Include details of the defect claimed, and proof of date of original purchase.