

This Owner's Manual is provided and hosted by [Appliance Factory Parts](#).



# PANASONIC MC-V5502 Owner's Manual

[Shop genuine replacement parts for PANASONIC  
MC-V5502](#)



[Find Your PANASONIC Vacuum Cleaner Parts - Select From 605 Models](#)

----- Manual continues below -----

# Operating Instructions

**HeavyDuty Plus**

COMMERCIAL VACUUM CLEANER  
**MC-V5502**

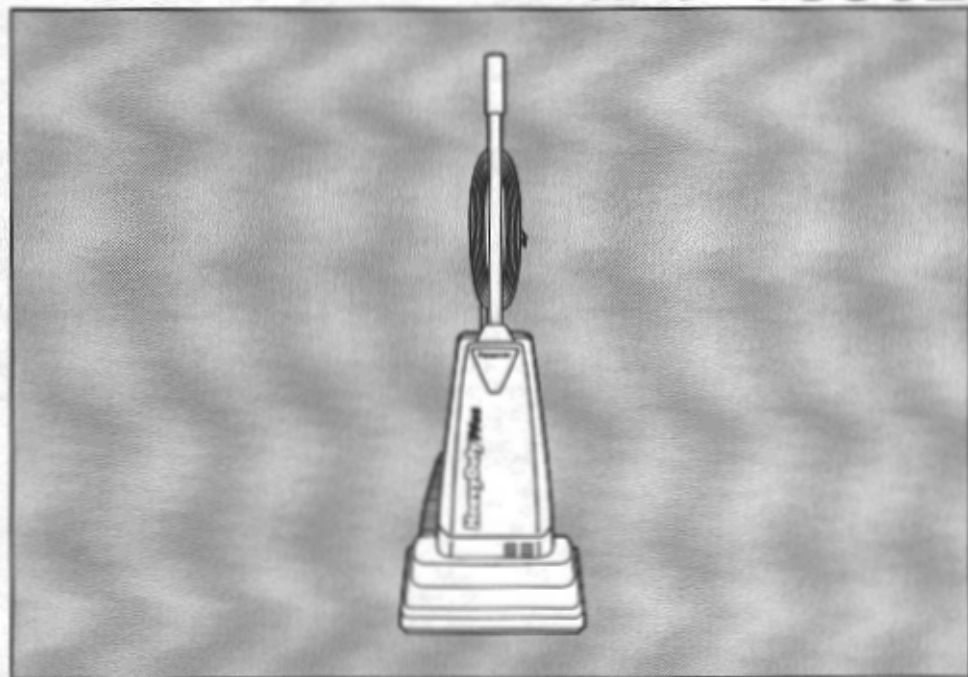

**Panasonic®**

Before operating your vacuum cleaner, please read these instructions completely.

C01ZARF00U00

# CONSUMER INFORMATION

Please read **IMPORTANT SAFETY INSTRUCTIONS** on page 4 before use. Read and understand all instructions.

## TO OUR VALUED CUSTOMER

We are very pleased to welcome you to the Panasonic family of products. Thank you for purchasing this product. Our intent is that you become one of our many satisfied customers.

**Proper assembly and safe use of your vacuum cleaner are your responsibilities. Your vacuum cleaner is intended for commercial use. The cleaner should be stored in a dry, indoor area. Read the Operating Instructions carefully for important use and safety information.**

**Special care is required when vacuuming certain types of carpet or floor covering. Always check the carpet or floor covering manufacturer's recommended cleaning instructions before vacuuming.**

**PLEASE PAY CLOSE ATTENTION TO THE WARNING AND CAUTION STATEMENTS THAT ARE FOUND THROUGHOUT THIS MANUAL.**



**WARNING** statements are designed to alert you to the possibility of personal injury, loss of human life, and/or damage to the vacuum cleaner and/or personal property if the instructions given are not followed.



**CAUTION** statements are designed to alert you to the possibility of damage to the vacuum cleaner and/or personal property if the instructions given are not followed.



### TO AVOID ELECTRIC SHOCK

Never vacuum damp or wet surfaces or liquids.   
DO NOT store machine outdoors.   
Replace worn or frayed power cord immediately.

### TO AVOID ACCIDENTS

Except for hand-held cleaners, keep machine on floor - not chairs, tables, steps, stairs, etc.   
Store machine promptly after each use to prevent accidents such as tripping over power cord or machine.   
Use machine and accessories only in a manner intended by the manufacturer.   
The use of an extension cord is not recommended.

©1998 Matsushita Electric Industrial Co., Ltd. All rights reserved.

# TABLE OF CONTENTS

<b>CONSUMER INFORMATION</b> .....	2
<b>IMPORTANT SAFETY INSTRUCTIONS</b> .....	4
<b>GROUNDING INSTRUCTIONS</b> .....	5
<b>PARTS IDENTIFICATION</b> .....	6
Feature Chart .....	6
<b>TO ASSEMBLE CLEANER</b> .....	7
Attaching Handle to Vacuum Cleaner .....	7
Attachments, Optional Accessories .....	8
<b>SPECIAL FEATURES OF CLEANER</b> .....	9
Automatic Self Adjusting Nozzle .....	9
Edge Cleaning Feature .....	9
Motor Protector .....	9
<b>TO OPERATE CLEANER</b> .....	10
On/Off Switch .....	10
Handle Adjustments .....	10
Attachments, Optional Accessories .....	11
<b>ROUTINE CARE OF CLEANER</b> .....	12
Cleaning Secondary Foam Filter .....	12
Changing the Dust Bag .....	13
Removing/Installing the Lower Plate .....	14
Replacing the Belt .....	15
Cleaning the Agitator .....	15
Replacing the Brushes .....	16
Cleaning Exterior and Attachments .....	17
Removing Clogs .....	17
<b>BEFORE REQUESTING SERVICE</b> .....	18
<b>WARRANTY</b> .....	19
<b>WHAT TO DO WHEN SERVICE IS NEEDED</b> .....	20

# IMPORTANT SAFETY INSTRUCTIONS

When using vacuum cleaner, basic precautions should always be followed, including the following:

## READ ALL INSTRUCTIONS BEFORE USING THIS VACUUM CLEANER

### WARNING

To reduce the risk of fire, electrical shock, injury:

1. **DO NOT** leave vacuum cleaner when plugged in. Unplug from outlet when not in use and before servicing.
2. To reduce the risk of fire, electric shock - **DO NOT** use outdoors or on wet surfaces.
3. **DO NOT** allow to be used as a toy. Close attention is necessary when used by or near children.
4. Use only as described in this manual. Use only manufacturer's recommended attachments.
5. **DO NOT** use with damaged cord or plug. If vacuum cleaner is not working as it should, has been dropped, damaged, left outdoors, or dropped into water, return it to an authorized Panasonic Servicenter.
6. **DO NOT** pull or carry by cord, use cord as a handle, close door on cord, or pull cord around sharp edges or corners. **DO NOT** run vacuum cleaner over cord. Keep cord away from heated surfaces.
7. **DO NOT** unplug by pulling on cord. To unplug, grasp the plug, not the cord.
8. **DO NOT** handle plug or vacuum cleaner with wet hands.
9. **DO NOT** put any objects into openings. **DO NOT** use with any opening blocked; keep free of dust, lint, hair, and anything that may reduce air flow.
10. Keep hair, loose clothing, fingers, and all parts of body away from openings and moving parts.
11. **DO NOT** pick up anything that is burning or smoking, such as cigarettes, matches, or hot ashes.
12. **DO NOT** use without dust bag and/or filters in place.
13. Turn off all controls before unplugging.
14. Use extra care when cleaning on stairs.
15. **DO NOT** use cleaner to pick up flammable or combustible liquids such as gasoline or use in areas where they may be present.
16. Connect to a properly grounded outlet only. See "Grounding Instructions."

## SAVE THESE INSTRUCTIONS

# GROUNDING INSTRUCTIONS

This vacuum cleaner must be grounded. If it should malfunction or breakdown, grounding provides a path of least resistance for electric current to reduce the risk of electric shock. This vacuum cleaner is equipped with a cord having an equipment-grounding conductor and grounding plug. The plug must be plugged into an appropriate outlet that is properly installed and grounded in accordance with all local codes and ordinances.

## **DANGER**

Improper connection of the equipment-grounding conductor can result in a risk of electric shock. Check with a qualified electrician or service person if you are in doubt as to whether the outlet is properly grounded. Do not modify the plug provided with the vacuum cleaner – if it will not fit the outlet, have a proper outlet installed by a qualified electrician.

This vacuum cleaner is for use on a nominal 120-volt circuit, and has a grounding plug that looks like the plug illustrated in sketch A in the following Figure. Make sure that this vacuum cleaner is connected to an outlet having the same configuration as the plug.

No adapter should be used with this vacuum cleaner.

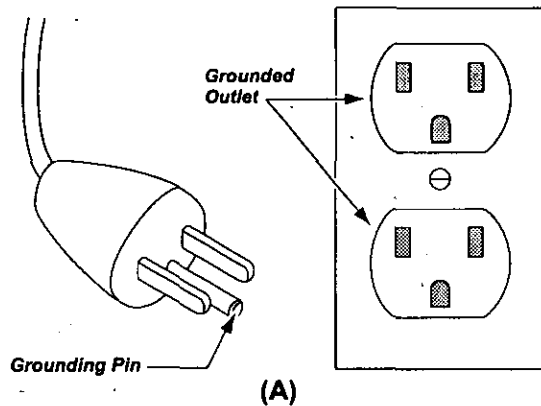

**Note:** Before you plug in your Panasonic vacuum cleaner, make sure that the voltage indicated on the rating plate located at the back of the vacuum cleaner is the same as your local supply.

# PARTS IDENTIFICATION

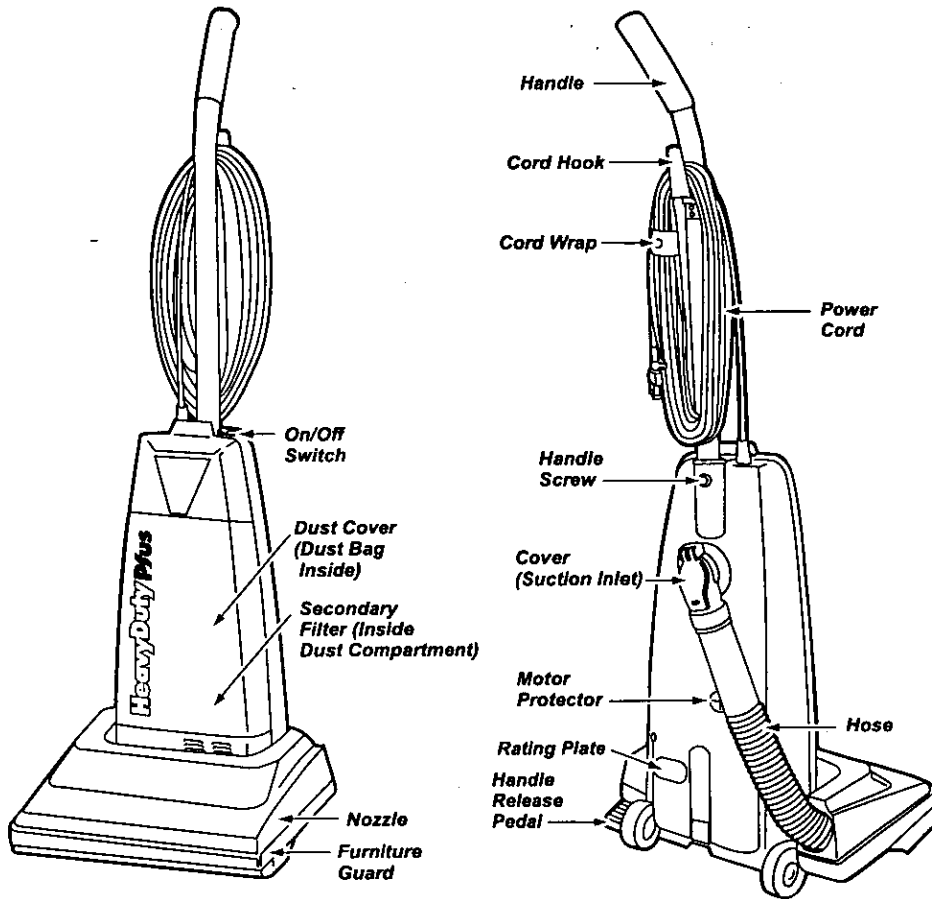

## FEATURE CHART

(PANASONIC UPRIGHT VACUUM CLEANER)

FEATURES	POWER	CORD WRAP	EDGE CLEANING	CORD LENGTH	CARPET HEIGHT ADJUST	MOTOR PROTECTOR
Model						
MC-V5502	120V. AC(60Hz) 9.0 Amps	Yes	Yes	35 Ft.	Auto	Yes

# TO ASSEMBLE CLEANER



## **WARNING** *Electrical Shock Hazard.*

**DO NOT** plug into electrical supply until assembly is complete. Failure to do so could result in electrical shock or injury.

### ATTACHING HANDLE TO VACUUM CLEANER

The vacuum cleaner main body and handle are packed separately.

1. The handle screw has been installed for shipping purposes. Please remove the screw before inserting the handle. Insert the handle as shown in the illustration. Ensure that the cord hook is on the back side of the handle before inserting.

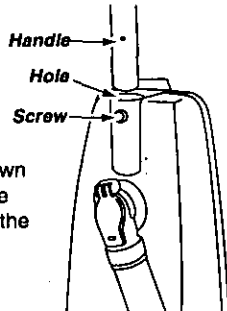

2. Insert the screw that you have removed. Be sure the screw is tightened, but not overtightened.

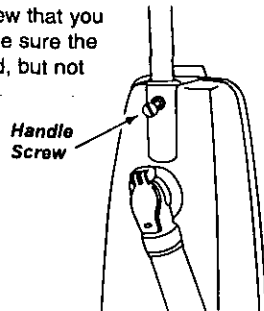

3. There is a recessed area between the cord hook base and the handle that is designed to secure the power cord during vacuuming.

Always push the power cord down into this recessed area to help keep the power cord from hanging near the nozzle and being damaged by the agitator.

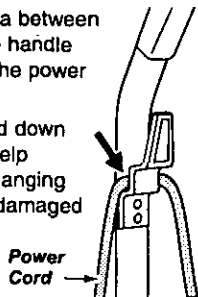

4. Loosely wrap the power cord around the cord hook. Secure the plug head to the cord by pushing the power cord into the retainer on the plug head. Place the cord wrap around the bottom loop of the cord.

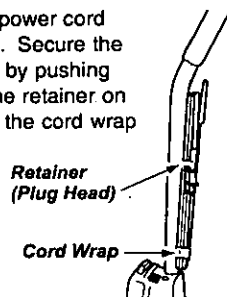

# ATTACHMENTS, Optional Accessories



## CAUTION

**DO NOT** get the power cord caught under the nozzle when using the vacuum or attachments as it can be damaged by the agitator as it revolves.

The attachments for this unit are optional. For information on how to obtain these items consult the Servicenter list that is packaged with this manual or contact any authorized Panasonic vacuum cleaner dealer.

### DELUXE TOOL KIT (MC-770AD)

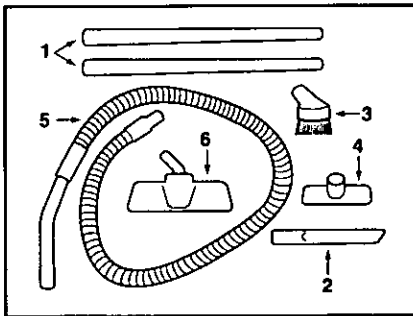

1. Metal Extension Wand (2 pieces).
2. Crevice Tool.
3. Dusting Brush.
4. Upholstery Tool.
5. Hose Assembly (includes curved wand and grommet).
6. 3-Way Floor Nozzle.

### STANDARD TOOL KIT (MC-670AS/MC-680AS)

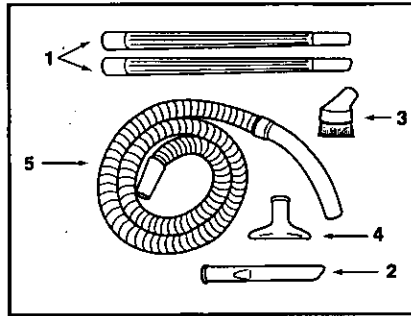

1. Plastic Extension Wand (2 pieces).
2. Crevice Tool.
3. Dusting Brush.
4. Upholstery Tool.
5. Hose Assembly (includes curved wand and grommet).

### SNAP ON TOOL KIT (MC-880AD)

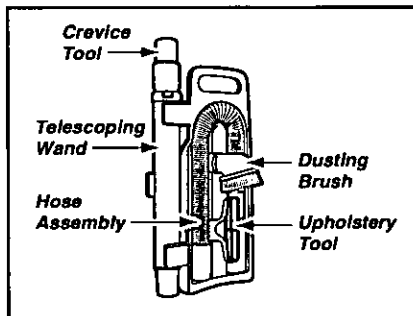

1. Telescoping Wand.
2. Crevice Tool.
3. Dusting Brush.
4. Upholstery Tool.
5. Hose Assembly.

# SPECIAL FEATURES OF CLEANER

## AUTOMATIC SELF ADJUSTING NOZZLE

Your Panasonic upright vacuum cleaner is designed with an automatic self adjusting nozzle. No manual adjustments are required. The height of the nozzle is instantly and automatically adjusted to any carpet pile height. This self adjusting feature allows the nozzle to float evenly over all carpet pile surfaces.

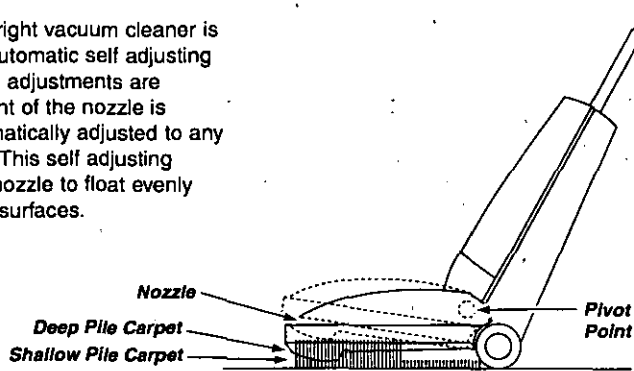

## EDGE CLEANING FEATURE

The edge cleaning feature provides for improved cleaning of carpets near walls and furniture.

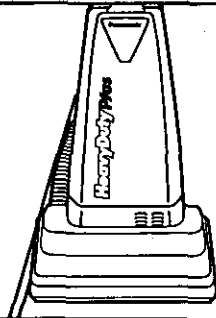

## MOTOR PROTECTOR

This vacuum has a motor protector by-pass valve which automatically opens to provide cooling air to the motor when a clog prevents the normal flow of air to the motor. The by-pass valve opens to prevent the motor from overheating and possibly causing damage to the vacuum. When open, a change of sound will be noticed as air rushes through the valve opening. If this occurs, turn the vacuum off and unplug the power cord from the outlet. Check for clogs as described in the REMOVING CLOGS section.

The motor protector by-pass valve may open when using attachments or when cleaning new carpet, due to reduced air flow by the attachments themselves or by new carpet fuzz filling the bag quickly.

Motor Protector

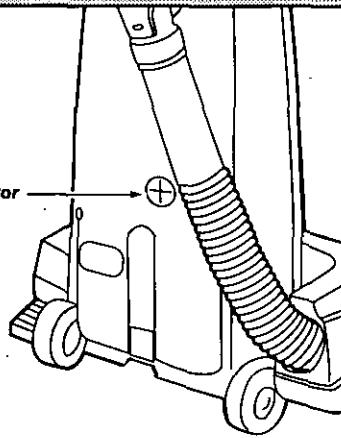

# TO OPERATE CLEANER



## CAUTION

**DO NOT use outlets above counters. Damage to items in the surrounding areas could occur. Be sure the switch is in the off position while plugging the cord in.**

### ON/OFF SWITCH

1. Plug the power cord into a 120V outlet.
2. To start the vacuum cleaner, push the switch to the ON position.
3. To stop the vacuum cleaner, push the switch to the OFF position.

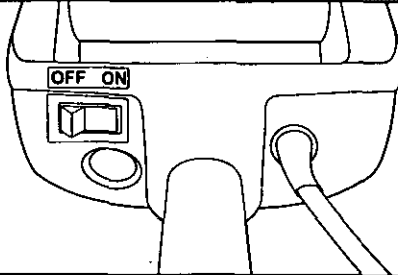

### HANDLE ADJUSTMENTS

The handle may be lowered to any position required. Just step on the handle release pedal as indicated by the illustration and lower the handle as desired.

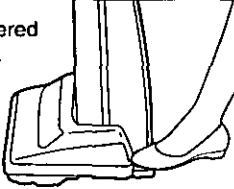

#### 1. Upright position

The handle locks in this position for storage. The handle should always be in an upright position when the attachments are used.

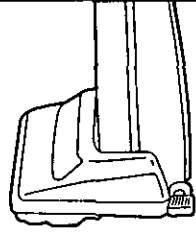

#### 2. Middle position

This position is for normal cleaning.

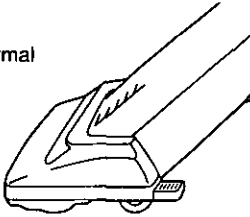

#### 3. Low position

This position is used for cleaning under furniture.

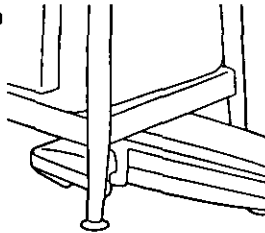



# WARNING *Personal Injury Hazard when Using Attachments.*

**DO NOT** place hands or feet underneath the unit when using the attachment tools. The agitator begins to revolve rapidly when using attachments.

## ATTACHMENTS, Optional Accessories



# CAUTION

When using the attachments, the agitator begins rotating. **DO NOT** allow the cleaner to remain in just one place for a period of time, as the agitator may damage the floor surface. Avoid placing the cleaner on furniture, the fringed area of rugs, deep pile carpeting, or carpeted stairs. The ideal position for the cleaner when using attachments is for the unit to be on a level area with the handle in the full upright position. See the **HANDLE ADJUSTMENTS** section.

### TO CONNECT OPTIONAL HOSE, ALL KITS

To connect the accessory hose to your vacuum cleaner, simply lift up the suction inlet cover located on the back of your cleaner and insert the hose end into the opening as illustrated. Be sure the hose is fitted snugly in the opening for proper operation.

**Note:** If the opening is dusty, first wipe with a clean cloth. Insert the tapered hose end fully and give it a slight twist for a snug fit.

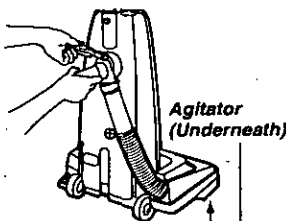

### TO CONNECT OPTIONAL CLEANING TOOLS

1. Connect any of the cleaning tools to the end of the extension wand/wands or directly to the hose assembly in the following manner. Push the cleaning tool onto the extension wand/wands or hose assembly and twist slightly for a firm connection. To remove the cleaning tool from the extension wand/wands or hose assembly, simply pull it apart.

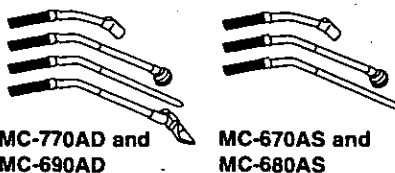

2. Remove the telescoping wand, MC-880AD, from its storage position. Remove the crevice tool from its storage position in the wand by pulling up. Turn the wand locking ring to the UNLOCK position. Extend the wand to its full length. Turn the wand locking ring to the LOCK position.

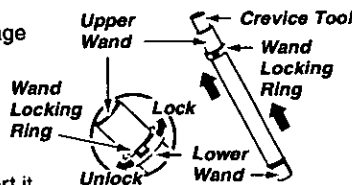

3. Attach the wand to the hose, twisting slightly as you insert it. To achieve the maximum reach, approximately 10 feet, with the attachments, add the crevice tool to the end of the wand. The dusting brush or the upholstery tool can be attached directly to the wand, hose, or to the end of the crevice tool. For the correct way to position the dusting brush or the upholstery tool see the illustration.

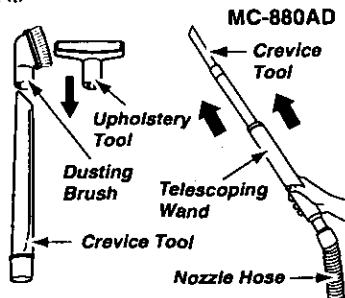

**\*Always clean attachments before using on fabrics. Attachments used in dirty areas, such as under a refrigerator, should not be used on other surfaces until they are washed. They could leave marks. See the CLEANING EXTERIOR AND ATTACHMENTS section.**

# ROUTINE CARE OF CLEANER

Performing the following tasks will keep your new Panasonic vacuum cleaner operating at peak performance levels and will ensure these high levels for years to come. Check the BEFORE REQUESTING SERVICE section in this manual for recommendations on performing some of these tasks to help solve various problems that may occur.



## **WARNING** *Electrical Shock or Personal Injury Hazard.*

*Always disconnect electrical supply before performing any service and/or cleaning of the vacuum cleaner. Failure to do so could result in electrical shock or personal injury from cleaner suddenly starting. DO NOT operate the cleaner without the secondary filter. Be sure the secondary filter is properly installed. Failure to do so could result in motor failure.*

## **CLEANING SECONDARY FOAM FILTER**

A secondary foam filter protects the motor from dirt. When installing a new dust bag, check this filter. Accumulated dirt in the dust compartment will collect on the filter and may restrict motor performance. When the filter becomes dirty, pull it from the bottom of the dust compartment and clean by rinsing with water. When dry, slide the filter back into place. Insert the secondary foam filter with a ruler or something flat. It should be fully inserted under the plastic rib projections all the way to the rear.

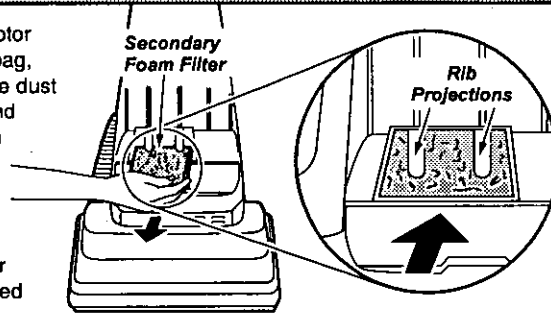

## CHANGING THE DUST BAG

Always operate the vacuum with a genuine Panasonic Type U3 Standard or U6 Electrostatic dust bag installed. Panasonic dust bags may be ordered through any authorized Panasonic dealer. An optional cloth bag is available.

1. Pull outward on the dust cover grip, located on the top of the dust cover and remove the cover.

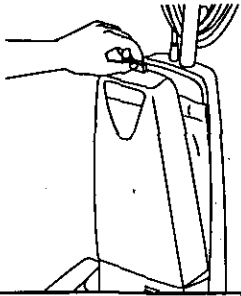

2. To remove the dust bag, grasp the cardboard portion of the dust bag and pull it out.

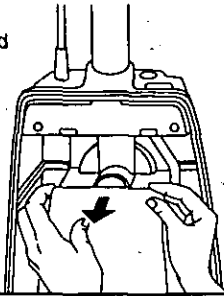

3. Spread out the end of the new dust bag.

**NOTE:** Pull carefully so as not to tear the bag at the folds.

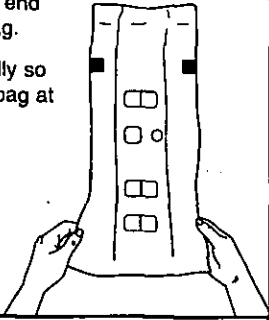

4. Attach the new dust bag onto the bag holder by holding the cardboard portion and pushing back as illustrated.

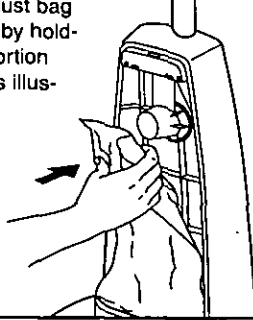

5. Reinsert the tab provided on the end of the dust cover into the groove on the dust compartment to allow the cover to rotate closed.

**NOTE:** The dust cover must be completely and correctly installed for proper operation.

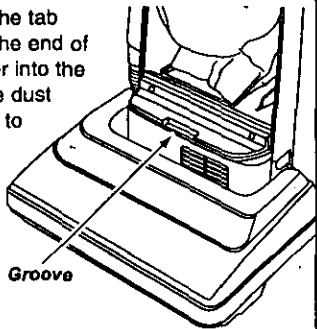

6. Rotate the dust cover up into the closed position and press into place.

**NOTE:** The dust bag should not be caught between the lower edge of the dust cover and the gasket as indicated by the arrow in the illustration.

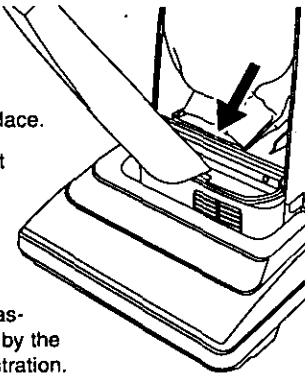



## **WARNING** *Electric Shock or Personal Injury Hazard.*

*When the lower plate is removed for any reason, before reinstalling, be sure that all electrical wires are routed in a manner that prevents them from coming into contact with the lower plate, lower plate screws, or any moving parts. Be sure that the wires are not pinched in any way when the lower plate is reinstalled.*

## **REMOVING/INSTALLING THE LOWER PLATE**

**Before replacing any parts, disconnect the vacuum cleaner from the electrical outlet.**

Replacing some of the parts in this section involves the removal and installation of the lower plate. Always place paper under nozzle anytime the lower plate is removed to protect the floor surface.

### **To Remove Lower Plate.**

Start by placing the handle in the low position. See the HANDLE ADJUSTMENTS section. Turn the vacuum cleaner over, exposing the underside. Release the lower plate by pressing the two (2) latches that secure the lower plate inward, as shown in the illustration. Remove the lower plate and remove any residue that may exist in the belt area.

### **To Reinstall Lower Plate.**

Close the rear belt cover. Hook the front end of lower plate onto the tabs on the front of the nozzle housing. Press the lower plate into place and fasten by pushing the two (2) latches outward.

**NOTE:** To ensure maximum cleaning efficiency, the belt should be checked regularly to make sure it is in good condition. Check to see if the belt is stretched, cracked, or if excessive slippage has occurred. Replace if necessary.

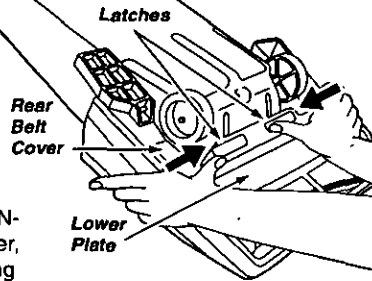

## REPLACING THE BELT



### **WARNING** Personal Injury Hazard.

Be careful when removing agitator. The belt tension is high. Failure to do so could result in personal injury from agitator releasing quickly and snapping away.

Unplug and turn the unit over. Remove the lower plate as described in the REMOVING/INSTALLING THE LOWER PLATE section. Close the rear belt cover.

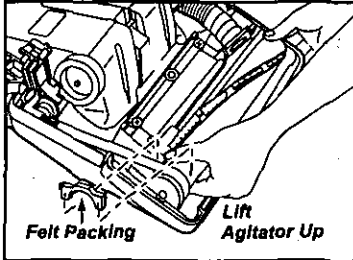

Remove the felt packing. Remove the agitator by carefully lifting it out, and remove the worn or broken belt from the agitator pulley and motor shaft.

Loop the new belt around the motor shaft and loop it around the agitator pulley. See illustration for correct belt routing. Use only a Panasonic Type UB8 drive belt.

Before reinserting the agitator make sure the end caps (rubber) are on correctly. See illustration in the REPLACING THE BRUSHES section.

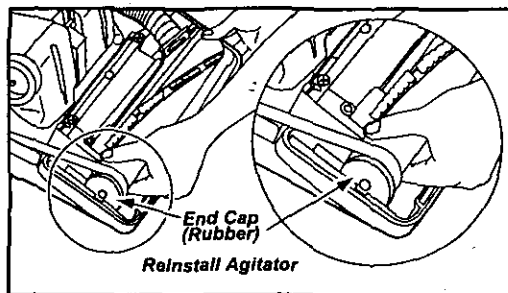
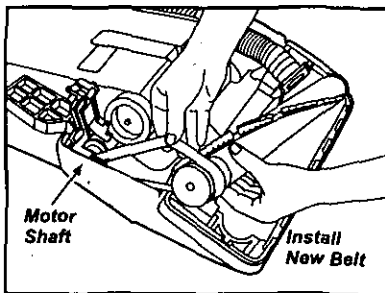

After checking the end caps (rubber), reinstall the agitator back into the housing grooves and replace the felt packing. After installing the agitator, turn it by hand making sure that the belt is not twisted or pinched and all rotating parts turn freely. Close the rear belt cover. Replace the lower plate as described in the REMOVING/INSTALLING THE LOWER PLATE section.

## CLEANING THE AGITATOR

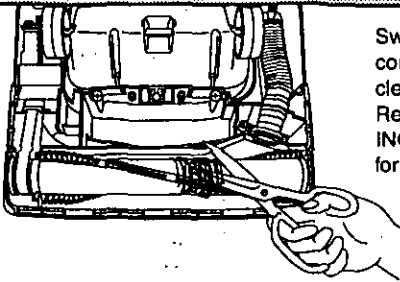

Switch off the vacuum cleaner and unplug the power cord before cleaning the agitator. In order to keep the cleaning efficiency high, clean the agitator regularly. Remove the lower plate if necessary. See the REMOVING/INSTALLING THE LOWER PLATE section for the proper procedure.

Agitator - Cut off any carpet pile and lint entangled around the agitator with a pair of scissors as illustrated.

# REPLACING THE BRUSHES

## 1. When to replace the brushes.

The brushes should be replaced when they are worn. Brushes should be checked by holding a card across the lower plate, see illustration. If the bristles on the agitator **DO NOT** touch the card, you **SHOULD** replace the brushes for best cleaning results.

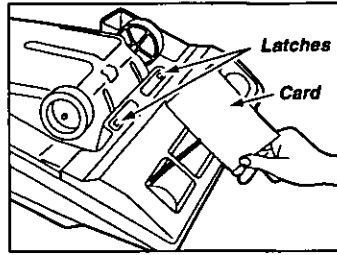

## 2. How to replace the brushes.

Remove the lower plate as outlined in the REMOVING/INSTALLING THE LOWER PLATE section. After the lower plate is removed, carefully lift up the agitator until it clears both sides of the nozzle housing. While holding the agitator up, remove the belt and the end caps (rubber). Carefully remove the E-clip from the agitator shaft using a small screwdriver and then remove the right end cap (metal). Pull the agitator shaft of the opposite end of the agitator and pull or pry out the agitator pulley and agitator holder. The brushes can now be replaced easily. Each brush must be inserted so that the end with eleven (11) tufts is placed on the side of the agitator body closest to the belt pulley. Push each brush as shown in the illustration until it is free from the agitator body. Install the new brushes by reversing the procedure. Reinstall the agitator holder, agitator pulley, making sure they are completely and firmly inserted, the agitator shaft/end cap (metal), and E-clip in the reverse order of removal. See the exploded view below for the correct assembly of all parts.

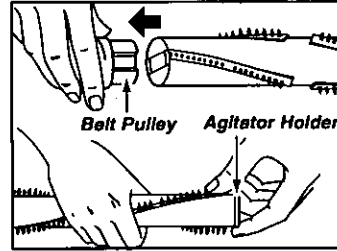
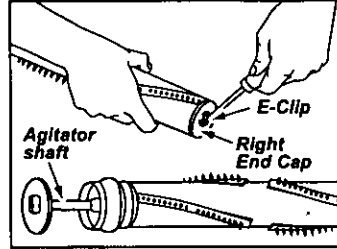

**NOTE:** Take care not to bend the agitator shaft. **DO NOT** misplace the small E-clip. Be careful when removing and re-installing it on the agitator shaft end, as it can easily get away from you.

## 3. To replace the agitator.

Place the belt over the belt pulley on the agitator. **NOTE:** There is a place for the belt to fit on one end of the agitator only. After assembling the belt, place the agitator back into the nozzle housing by aligning each end cap (rubber).

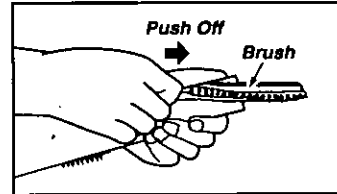

After completing the assembly, rotate the brush, turning it by hand to assure that it rotates smoothly and the part is assembled correctly.

Replace the lower plate as outlined in the REMOVING/INSTALLING THE LOWER PLATE section.

## AGITATOR ASSEMBLY

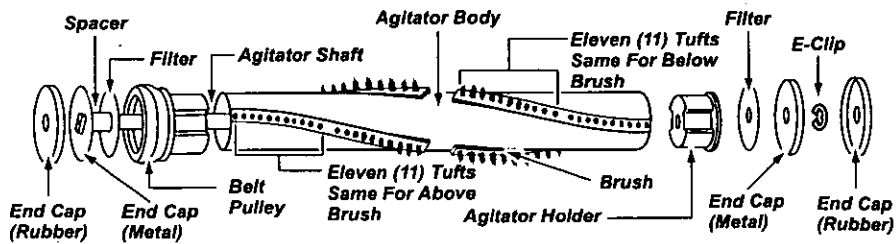

## CLEANING EXTERIOR AND ATTACHMENTS

1. Unplug cord from wall outlet. **DO NOT drip water on cleaner.**
2. Clean exterior using a clean, soft cloth that has been dipped in a solution of mild liquid detergent and water and wrung dry. Wipe dry after cleaning.
3. To reduce static electricity and dust build-up, wipe outer surface of cleaner and attachments.
4. Wash attachments in warm soapy water, rinse and air dry. **DO NOT clean in dishwasher or clothes washer.**

**DO NOT USE ATTACHMENTS IF THEY ARE WET.**



## CAUTION

*Attachments used in dirty areas, such as under a refrigerator, should not be used on other surfaces until they are washed. They could leave marks.*

## REMOVING CLOGS

The hose located on the back of the vacuum cleaner carries the dirt from the nozzle up to the dust bag. If the hose should become clogged:

1. Unplug the power cord from the outlet before checking the airflow passages. Pull open the suction inlet cover and check for clogging in this area.

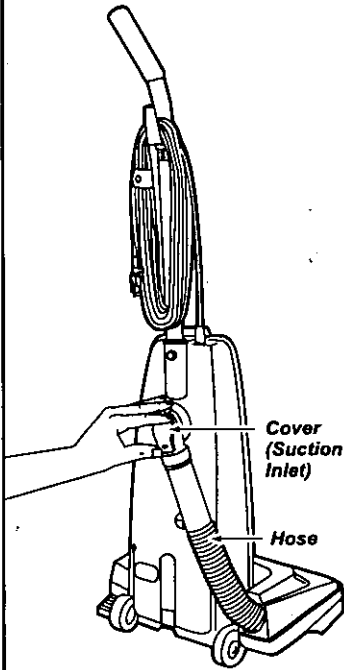

2. Disconnect any optional accessories that may be in use and check them for clogging. Plug in the vacuum cleaner and turn it on. While running the vacuum cleaner with the accessories disconnected, stretch the hose in and out to remove the clog.

3. If the clog still exists, turn the vacuum cleaner OFF and unplug the power cord. Turn the vacuum cleaner over, exposing the underside. Remove the lower plate. Remove the hose from the housing by lifting it straight up. Inspect the hose end and clear it of any obstructions. Reinstall the hose and lower plate. See the REMOVING/ INSTALLING THE LOWER PLATE section for detailed instructions.

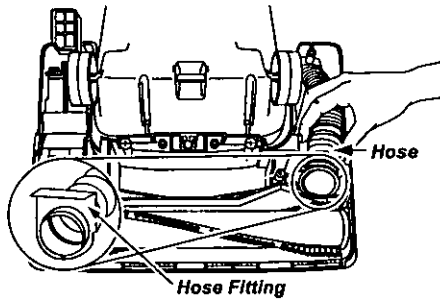

# BEFORE REQUESTING SERVICE



## **WARNING** *Electric Shock or Personal Injury Hazard.*

*Disconnect the electrical supply before servicing or cleaning the unit. Failure to do so could result in electric shock or personal injury from cleaner suddenly starting.*

Review this chart to find do-it-yourself solutions for minor performance problems. Any service needed, other than those described in these Operating Instructions, should be performed by an authorized service representative.

<b>PROBLEM</b>	<b>POSSIBLE CAUSE</b>	<b>POSSIBLE SOLUTION</b>
<b>Cleaner will not run.</b>	<ol style="list-style-type: none"> <li>1. Unplugged at wall outlet.</li> <li>2. ON/OFF switch not turned on.</li> <li>3. Tripped circuit breaker/blown fuse at household service panel.</li> </ol>	<ol style="list-style-type: none"> <li>1. Plug in firmly. Push ON/OFF switch to On.</li> <li>2. Push ON/OFF switch to ON.</li> <li>3. Reset circuit breaker or replace fuse.</li> </ol>
<b>Poor job of dirt pickup.</b>	<ol style="list-style-type: none"> <li>1. Full or clogged dust bag.</li> <li>2. Broken belt.</li> <li>3. Clogged hose or nozzle.</li> <li>4. Hose not inserted fully.</li> <li>5. Worn brushes.</li> <li>6. Hole in hose.</li> <li>7. Dust cover improperly installed.</li> </ol>	<ol style="list-style-type: none"> <li>1. Change bag.</li> <li>2. Replace belt.</li> <li>3. Clean hose or nozzle area.</li> <li>4. Insert hose.</li> <li>5. Replace brushes.</li> <li>6. Replace hose.</li> <li>7. Properly install dust cover.</li> </ol>
<b>Dust escapes the paper bag.</b>	<ol style="list-style-type: none"> <li>1. Bag improperly installed.</li> <li>2. Bag torn.</li> </ol>	<ol style="list-style-type: none"> <li>1. Properly install bag.</li> <li>2. Replace bag.</li> </ol>

# WARRANTY

## Panasonic Commercial Vacuum Cleaner Limited Warranty

Panasonic Consumer Electronics Company (referred to as "the warrantor") will repair this product with new or refurbished parts free of charge, in the U.S.A. or Puerto Rico, for one (1) year from the date of original purchase, in the event of a defect in materials or workmanship.

**This Limited Warranty Excludes both Labor and Parts for the following items:** disposable dust bags, filters, belts, light bulbs, agitator brushes and batteries (if supplied).

Carry-in or mail-in service in the U.S.A. can be obtained during the warranty period by contacting a Panasonic Services Company (PASC) Factory Servicenter listed in the Servicenter Directory, or by calling toll free, 1-800-211-PANA (7262), or by contacting your selling distributor. Carry-in or mail-in service in Puerto Rico can be obtained during the warranty period by calling the local Panasonic Sales Company telephone number listed in the Servicenter Directory.

This warranty is extended only to the original purchaser. A purchase receipt or other proof of date of original purchase will be required before warranty performance is rendered.

This warranty only covers failures due to defects in materials and workmanship which occur during normal use and does not cover damages which occur in shipment, or failures which are caused by products not supplied by the warrantor, or failures which result from accident, misuse, abuse, neglect, mishandling, misapplication, faulty installation, improper operation or maintenance, alteration, modification, power line surge, improper voltage supply, lightning damage, or service by anyone other than a Panasonic Authorized Servicenter, or damage that is attributable to acts of God.

### **LIMITS AND EXCLUSIONS:**

There are no express warranties except as listed above.

THE WARRANTOR SHALL NOT BE LIABLE FOR INCIDENTAL OR CONSEQUENTIAL DAMAGES RESULTING FROM THE USE OF THIS PRODUCT, OR ARISING OUT OF ANY BREACH OF THIS WARRANTY. ALL EXPRESS AND IMPLIED WARRANTIES, INCLUDING THE WARRANTIES OF MERCHANTABILITY AND FITNESS FOR A PARTICULAR PURPOSE, ARE LIMITED TO THE APPLICABLE WARRANTY PERIOD SET FORTH ABOVE.

Some states do not allow the exclusion or limitation of incidental or consequential damages, or limitations on how long an implied warranty lasts, so the above exclusions or limitations may not apply to you.

This warranty gives you specific legal rights and you may also have other rights which vary from state to state. If a problem with this product develops during or after the warranty period, you may contact your dealer or Servicenter. If the problem is not handled to your satisfaction, then write to the Customer Satisfaction Center at the listed address on the back cover.

# WHAT TO DO WHEN SERVICE IS NEEDED

If your Panasonic Vacuum Cleaner needs service, look in the yellow pages of the telephone book under HOME APPLIANCE SERVICE for your nearest Panasonic Services Company ("PASC") Factory Servicenter, or PASC authorized Servicenter, or call 1-800-211-PANA (7262) toll free to find a convenient servicenter. **DO NOT** send the product to the Executive or Regional Sales offices. They are **NOT** equipped to make repairs.

## If you ship the product

Carefully pack and send it prepaid, adequately insured and preferably in the original carton. Attach a postage-paid letter to the outside of the carton, which contains a description of your complaint. **DO NOT send the product to the Executive or Regional Sales Offices. They are NOT equipped to make repairs.**

## Customer's Record

Model No. \_\_\_\_\_ Dealer's Name \_\_\_\_\_

Serial No. \_\_\_\_\_

Dealer's Address \_\_\_\_\_

Date of Purchase \_\_\_\_\_

PANASONIC CONSUMER  
ELECTRONICS COMPANY, DIVISION  
OF MATSUSHITA ELECTRIC  
CORPORATION OF AMERICA

One Panasonic Way  
Secaucus, New Jersey 07094

PANASONIC HOME & COMMERCIAL  
PRODUCTS COMPANY, DIVISION OF  
MATSUSHITA ELECTRIC  
CORPORATION OF AMERICA

One Panasonic Way  
Secaucus, New Jersey 07094

PANASONIC SALES COMPANY,  
MATSUSHITA ELECTRIC OF  
PUERTO RICO INC.

Ave. 65 de infantería, Km 9.5  
San Gabriel Industrial Park  
Carolina, Puerto Rico 00985

AC01ZARF0U  
C01ZARF00U00

Printed in U.S.A.