

This Owner's Manual is provided and hosted by [Appliance Factory Parts](#).



# PANASONIC MC-V7311 Owner's Manual

[Shop genuine replacement parts for PANASONIC  
MC-V7311](#)



[Find Your PANASONIC Vacuum Cleaner Parts - Select From 605 Models](#)

----- Manual continues below -----

# Panasonic®

VACUUM CLEANER  
*Aspiradora*

## MC-V7311

**Operating Instructions**  
*Instrucciones de operación*

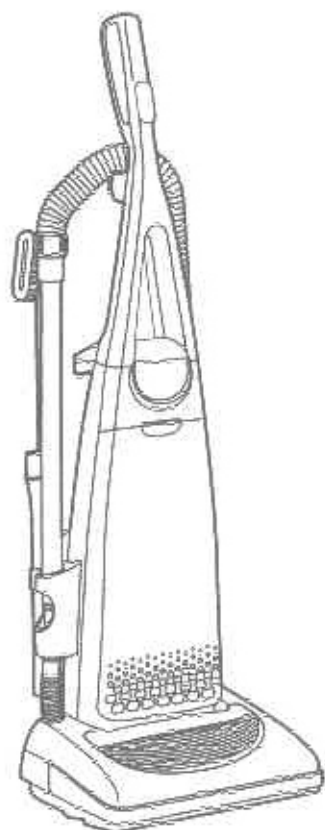

**Before operating your vacuum cleaner, please read these instructions completely.**

*Antes de usar su aspiradora, lea completamente estas instrucciones por favor.*

©1ZBVE00U00

# CONSUMER INFORMATION

Please read **IMPORTANT SAFETY INSTRUCTIONS** on page 5 before use. Read and understand all instructions.

## TO OUR VALUED CUSTOMER

We are very pleased to welcome you to the Panasonic family of products. Thank you for purchasing this product. Our intent is that you become one of our many satisfied customers.

Proper assembly and safe use of your vacuum cleaner are your responsibilities. Your vacuum cleaner is intended only for household use. The cleaner should be stored in a dry, indoor area. Read the Operating Instructions carefully for important use and safety information.

Special care is required when vacuuming certain types of carpet or floor covering. Always check the carpet or floor covering manufacturer's recommended cleaning instructions before vacuuming.

## PLEASE PAY CLOSE ATTENTION TO ALL WARNING AND CAUTION STATEMENTS.



**WARNING** statements are designed to alert you to the possibility of personal injury, loss of human life, and/or damage to the vacuum cleaner and/or personal property if the instructions given are not followed.



**CAUTION** statements are designed to alert you to the possibility of damage to the vacuum cleaner and/or personal property if the instructions given are not followed.



### TO AVOID ELECTRICAL SHOCK

Never vacuum damp or wet surfaces or liquids.  
DO NOT store machine outdoors.  
Replace worn or frayed power cord immediately.  
Unplug from outlet when not in use and before servicing.

### TO AVOID ACCIDENTS

Except for hand-held cleaners, keep machine on floor - not chairs, tables, steps, stairs, etc.  
Store machine promptly after each use to prevent accidents such as tripping over power cord or machine.  
Use machine and accessories only in a manner intended by the manufacturer.  
The use of an extension cord is not recommended.

©2002 Matsushita Electric Corporation of America. All rights reserved.

# TABLE OF CONTENTS / *Tabla de contenido*

<b>CONSUMER INFORMATION / Información para consumidor</b> .....	2-3
<b>IMPORTANT SAFETY INSTRUCTIONS</b> <i>Instrucciones importantes de seguridad</i> .....	5-6
<b>PARTS IDENTIFICATION / Identificación de piezas</b> .....	7
<b>ASSEMBLY / Montaje</b> .....	8
<b>Attaching Handle / Colocación del mango</b> .....	8
<b>Using Cord Reel / Usando el mecanismo de enrollar</b> .....	8
<b>Tool Storage / Almacenaje de herramientas</b> .....	9
<b>FEATURES / Características</b> .....	10
<b>Automatic Self Adjusting Nozzle / Boquilla de ajuste automático</b> .....	10
<b>Edge Cleaning / Limpieza para orillas</b> .....	10
<b>Motor Protector / Protector del motor</b> .....	10
<b>Carpet-Bare Floor Selector / Selector carpet-bare floor</b> .....	11
<b>Hose Ring and Hose Ring Mount</b> <i>Anillo de manguera y soporte del anillo para manguera</i> .....	11
<b>TO OPERATE CLEANER / Para operar la aspiradora</b> .....	12
<b>Power Cord / Cordón eléctrico</b> .....	12
<b>ON-OFF Switch / Control ON-OFF</b> .....	12
<b>Handle Adjustments / Ajustes del mango</b> .....	12
<b>Using Tools / Uso de herramientas</b> .....	13
<b>ROUTINE CARE OF CLEANER / Cuidado de rutina de la aspiradora</b> .....	14
<b>Cleaning Secondary Foam Filter</b> <i>Limpieza del segundo filtro de goma espuma</i> .....	14
<b>Replacing HEPA Exhaust Filter / Cambiar del filtro de escape HEPA</b> .....	14
<b>Changing Dust Bag / Cambio de la bolsa de polvo</b> .....	15
<b>Removing and Installing Lower Plate</b> <i>Cambiar y insertar de la base inferior</i> .....	16
<b>Replacing Headlight Bulb / Cambio de la bombilla</b> .....	16
<b>Replacing Belt / Cambio de la correa</b> .....	17
<b>Cleaning Agitator / Limpieza del agitador</b> .....	18
<b>Replacing Agitator / Cambio del agitador</b> .....	18
<b>Cleaning Exterior and Tools / Limpieza del exterior y de los herramientas</b> .....	19
<b>Removing Clogs / Quitar de los residuos de basura en los conductos</b> .....	20
<b>BEFORE REQUESTING SERVICE / Antes de pedir servicio</b> .....	21-22
<b>NOTES / Notas</b> .....	23-25
<b>WARRANTY / Garantía</b> .....	26-27
<b>WHAT TO DO WHEN SERVICE IS NEEDED / Cuando necesita servicio</b> .....	28

# IMPORTANT SAFETY INSTRUCTIONS

When using vacuum cleaner, basic precautions should always be followed, including the following:

## READ ALL INSTRUCTIONS BEFORE USING THIS VACUUM CLEANER



## WARNING

To reduce the risk of fire, electrical shock, injury:

1. **DO NOT** leave vacuum cleaner when plugged in. Unplug from outlet when not in use and before servicing.
2. To reduce the risk of fire, electric shock - **DO NOT** use outdoors or on wet surfaces.
3. **DO NOT** allow to be used as a toy. Close attention is necessary when used by or near children.
4. Use only as described in this manual. Use only manufacturer's recommended tools.
5. **DO NOT** use with damaged cord or plug. If vacuum cleaner is not working as it should, has been dropped, damaged, left outdoors, or dropped into water, return it to an authorized Panasonic Servicenter.
6. **DO NOT** pull or carry by cord, use cord as a handle, close door on cord, or pull cord around sharp edges or corners. **DO NOT** run vacuum cleaner over cord. Keep cord away from heated surfaces.
7. **DO NOT** unplug by pulling on cord. To unplug, grasp the plug, not the cord.
8. **DO NOT** handle plug or vacuum cleaner with wet hands.
9. **DO NOT** put any objects into openings. **DO NOT** use with any opening blocked; keep free of dust, lint, hair, and anything that may reduce air flow.
10. Keep hair, loose clothing, fingers, and all parts of body away from openings and moving parts.
11. **DO NOT** pick up anything that is burning or smoking, such as cigarettes, matches, or hot ashes.
12. **DO NOT** use without dust bag and/or filters in place.
13. Turn off all controls before unplugging.
14. Use extra care when cleaning on stairs.
15. **DO NOT** use cleaner to pick up flammable or combustible liquids such as gasoline or use in areas where they may be present.
16. **HOLD** plug when rewinding onto cord reel. Do not allow plug to whip when rewinding.

## SAVE THESE INSTRUCTIONS

### THIS VACUUM CLEANER IS INTENDED FOR HOUSEHOLD USE ONLY

**Note:** Before you plug in your Panasonic vacuum cleaner, make sure that the voltage indicated on the rating plate located at the back of the vacuum cleaner is the same as your local supply.

# PARTS IDENTIFICATION

## Identificación de piezas

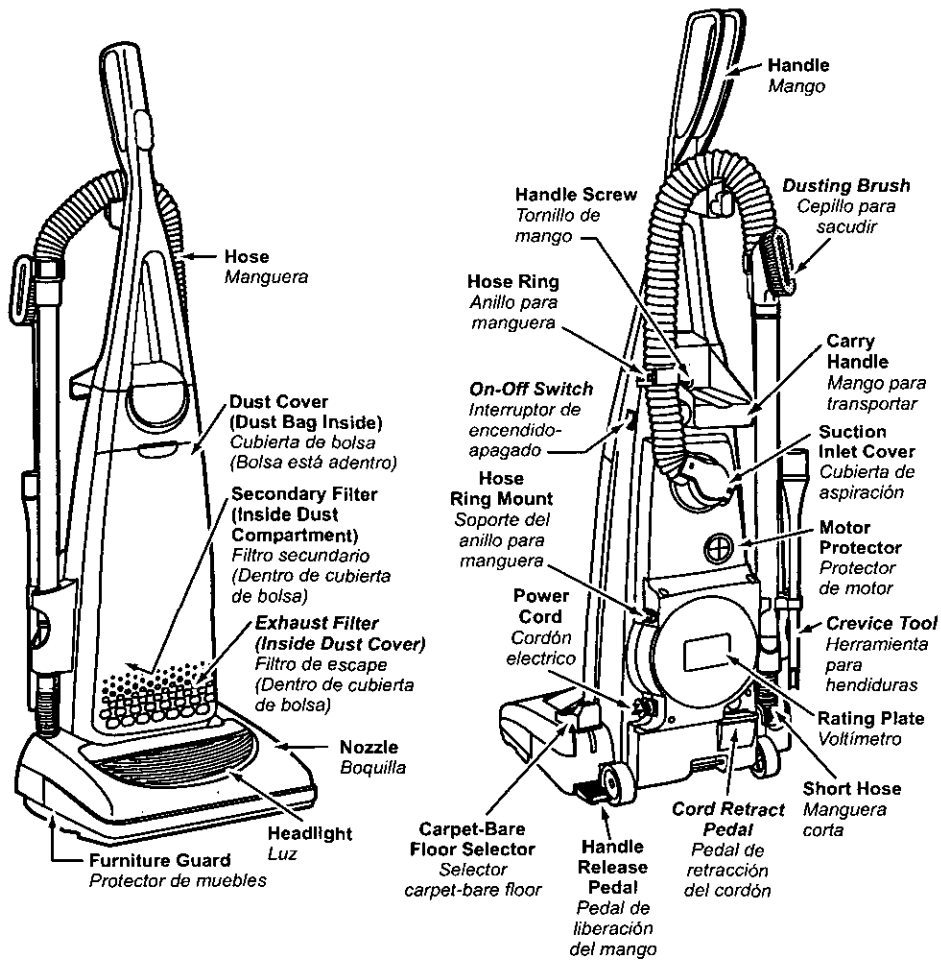

### FEATURE CHART / Diagrama de características (PANASONIC UPRIGHT VACUUM) (Aspiradora vertical Panasonic)

FEATURES Características	Power Voltaje	Cord Reel Mecanismo de enrollar el cordón	Headlight Luz	Cord Length Extensión de cordón	Bare Floor Uso sin alfombra
Model / Modelo MC-V7311	120V AC (60Hz) 12.0 A / 12.0 A	Yes Si	Yes Si	28 Ft. (8.5 m) 8,5 m (28 pi)	Yes Si

## ASSEMBLY / Montaje

### Attaching Handle / Colocación del mango

- 1)
  - **DO NOT plug in until assembly is complete**  
*No enchufe hasta que el montaje esté completo*
  - **Turn ON-OFF switch OFF**  
*Mueva el control ON-OFF a la posición OFF*
  - **Remove handle screw**  
*Quite el tornillo del mango*
  - **Insert handle**  
*Instale el mango*

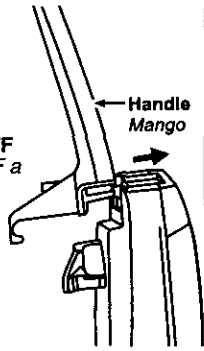

- 2)
  - **Insert screw**  
*Instale el tornillo*
  - **Tighten screw**  
*Apriete el tornillo*

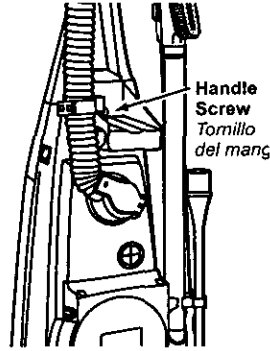

### Using Cord Reel / Usando el mecanismo de enrollar

- 1)
  - **Pull cord out of cord reel until the end is reached**  
*Tire del cordón del mecanismo de enrollar hasta que se alcance el extremo*
  - **Do not use vacuum without cord pulled out all the way**  
*No use la aspiradora sin que el cordón se extienda por completo*

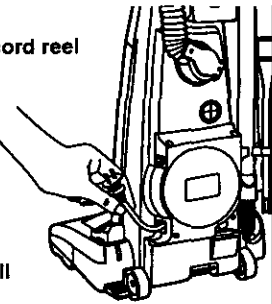

- 2)
  - **Push power cord into two (2) cord clips in back of handle**  
*Empuje el cordón eléctrico hasta las dos (2) áreas indicadas en la parte trasera del mango*

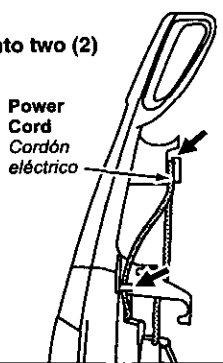

- 3)
  - **Plug the polarized power cord into a 120V outlet located near floor**  
*Conecte el cordón eléctrico polarizado en un enchufe de 120 V que se encuentre cerca del piso*

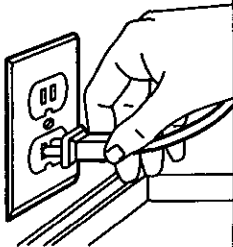

- 4)
  - **To prevent injury or damage, hold plug head while rewinding cord**  
*Tenga en la mano el enchufe del cordón para evitar lesión personal o daño mientras se rebobina el cordón*
  - **Push cord retract pedal down to rewind**  
*Empuje hacia abajo el pedal de retracción del cordón para rebobinar*

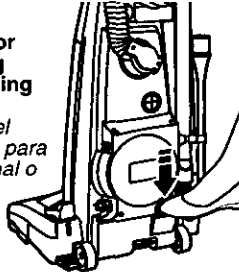

# Tool Storage / Almacenaje de herramientas

## Tools / Herramientas

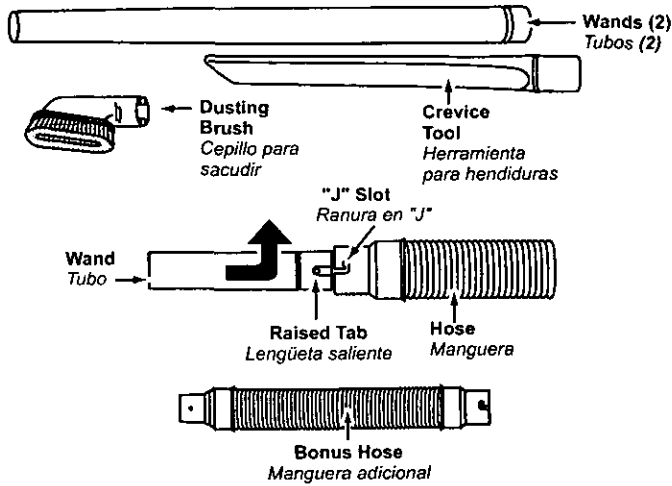

➤ **Some tools may already be stored on vacuum cleaner**  
*Es posible que ya se almacenen unas herramientas en la aspiradora*

➤ **Place hose in back of handle on hose holder**  
*Coloque la manguera en la parte trasera del soporte de manguera*

➤ **Attach wand to hose by aligning the two (2) raised tabs on wand with "J" slots in hose, guide tabs along grooves, twist to lock in place**  
*Para conectar el tubo a la manguera, alinee las dos (2) lengüetas levantadas en el tubo con las ranuras "J" en la manguera. Mueva las lengüetas hacia las ranuras, ruédelas para asegurar*

➤ **Place wand in front slot of tool holder, twisting and pushing down over short hose to assure a good connection**  
*Coloque el tubo en la ranura delantera del soporte para herramientas, rodando y empujando hacia abajo a la manguera corta para asegurar una conexión buena*

➤ **Store other wand, with combination brush on top, in round rear slot of tool holder**  
*Almacene el otro tubo con el cepillo de combinación en la parte superior en la ranura redonda y posterior del soporte para herramientas*

➤ **Place crevice tool into rectangular rear slot of tool holder**  
*Coloque la herramienta para tapices en la ranura posterior y rectangular del soporte de herramientas*

➤ **Refer to PARTS IDENTIFICATION section for tool location**  
*Véase la sección de "Identificación de piezas" para la ubicación de las herramientas*

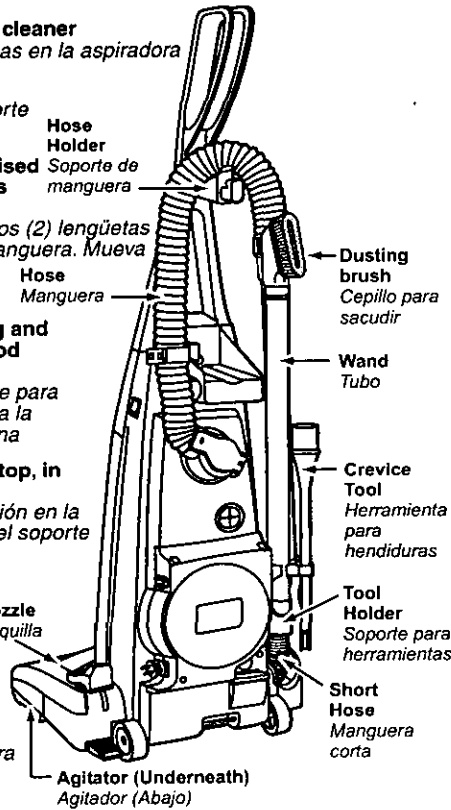

## FEATURES / Características

### Automatic Self Adjusting Nozzle Boquilla de ajuste automático

- **The nozzle of your Panasonic upright vacuum cleaner automatically adjusts to any carpet pile height**  
*La boquilla de su aspiradora vertical Panasonic se ajusta automáticamente a la altura de cualquier pelo de alfombra*
- **Feature allows nozzle to float evenly over carpet pile surfaces**  
*La característica permite que la boquilla flote fácilmente en las superficies del pelo de alfombra*
- **No manual adjustments required**  
*No se requieren los ajustes manuales*

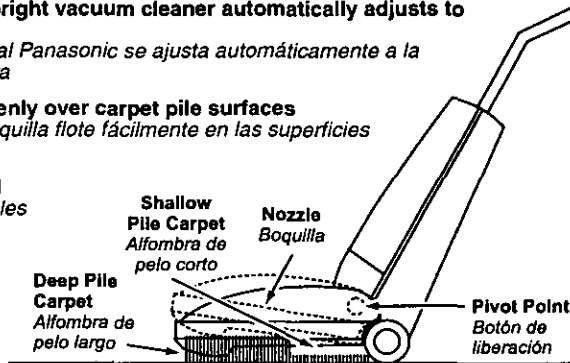

### Edge Cleaning / Limpieza para orillas

- **Edge cleaning feature provides for improved cleaning of carpets near walls and furniture**  
*Use la característica de limpieza para orillas para aspirar con facilidad cerca de las paredes y los muebles*

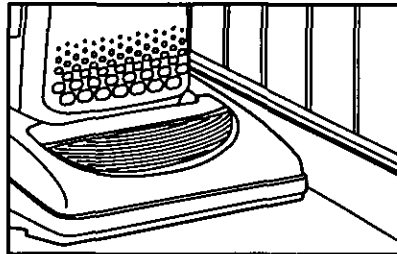

### Motor Protector / Protector del motor

- **Motor protector automatically opens to provide cooling air when a clog occurs or when bag needs changing**  
*Se abre automáticamente el protector del motor para proveer el aire fresco cuando hay unos residuos o cuando se necesita cambiar la bolsa*
- **Motor protector may open when using tools**  
*Es posible que el protector del motor se abra cuando se usan las herramientas*
- **Check operation by placing hand over end of hose**  
*Revise la operación al colocar la mano en el extremo de la manguera*

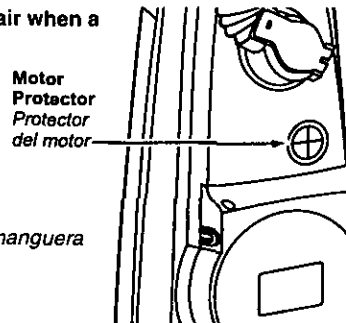

**Note: Do not block motor protector**  
*NOTA: No obstruye el protector de motor.*

## Carpet-Bare Floor Selector / Selector carpet-bare floor

- **Selector should be placed in BARE FLOOR (TOOLS) position when using cleaner on bare floors and when using tools**  
*Se debe colocado el selector en la posición para BARE FLOOR (TOOLS) cuando pasa la aspiradora en los suelos sin alfombra y cuando se usan las herramientas*

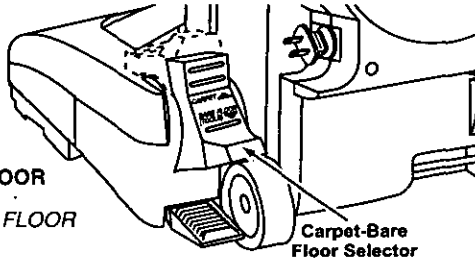

- **The agitator does not rotate in the BARE FLOOR (TOOLS) position**  
*El agitador no rueda en la posición para BARE FLOOR (TOOLS)*

- **Selector should be placed in CARPET position when using cleaner on carpeted floors**  
*Se debe colocado el selector en la posición para CARPET cuando pasa la aspiradora en los suelos con alfombra*

- **For longer belt life, turn vacuum off before moving selector**  
*Apague la aspiradora antes de mover el selector para una vida más larga de la correa*

- **Otherwise, take care when selecting either position to ensure selector is pushed fully and quickly as possible to desired position**  
*Siempre tenga cuidado al seleccionar cualquier posición para asegurar que el selector esté movido rápido y por completo a la posición deseado*

- **Failure to do so can cause belt to rub on selector shaft and result in belt becoming hot and creating a burning rubber smell**  
*Al no mover el selector rápido y por completo a la posición deseado, se puede causar que la correa friccionne en el eje del selector y resulte que la correa se caliente creando un olor a quemado de goma*



To Clean Bare Floor Or Use Tools  
*Para aspirar sobre un suelo sin alfombra o usar los accesorios*

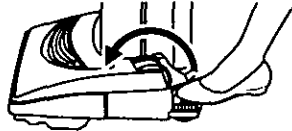

To Clean Carpet  
*Para aspirar sobre una alfombra*

## Hose Ring and Hose Ring Mount

### Anillo de manguera y soporte del anillo para manguera

- **Hose ring and hose ring mount are designed to prevent tipping of vacuum while using tools**  
*El anillo de manguera y el soporte del anillo para manguera están diseñados para impedir que la aspiradora no volque cuando se utilizan las herramientas*

- **Place hose ring in hose ring mount as shown in illustration**  
*Coloque el anillo para manguera en el soporte del anillo para manguera como se ve en el diagrama*

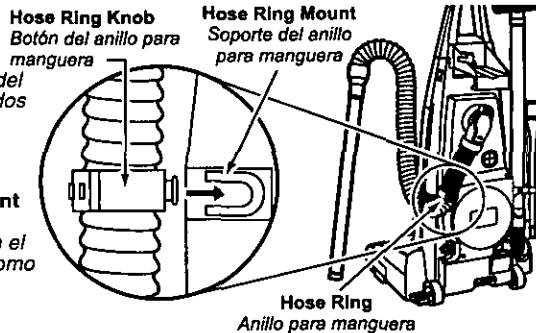

Hose Ring  
*Anillo para manguera*

# TO OPERATE CLEANER

## Para operar la aspiradora

### Power Cord / Cordón eléctrico

**NOTE:** To reduce the risk of electrical shock, this vacuum has a polarized plug, one blade is wider than the other. This plug will fit in a polarized outlet only one way. If the plug does not fit fully in the outlet, reverse the plug. If it still does not fit, contact a qualified electrician to install the proper outlet. **DO NOT CHANGE THE PLUG IN ANY WAY.** Only use outlets near the floor.

**Nota:** Para reducir el riesgo de choque eléctrico, esta aspiradora cuenta con una clavija polarizada, uno de los contactos es más ancho que el otro. La clavija sólo puede insertarse de una manera en el enchufe. Si la clavija no cabe bien en el enchufe, inviértala. Si aún no cabe, llame a un electricista para que instale un enchufe correcto. No altere la clavija de ninguna manera. No altere la clavija de ninguna manera. Use solamente las tomas de pared cercas del suelo.

### ON-OFF Switch / Control ON-OFF

- **Ensure ON-OFF switch is OFF**  
Asegúrese de que el control ON-OFF esté en la posición OFF
- **Plug the power cord into 120V outlet**  
Enchufe el cordón eléctrico en una toma de pared de 120 V
- **ON position turns vacuum on**  
La posición ON enciende la aspiradora
- **OFF position turns off vacuum**  
La posición OFF apaga la aspiradora

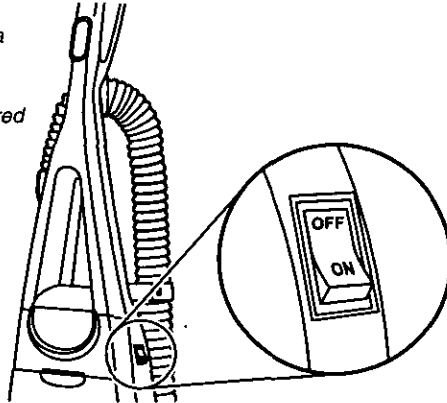

### Handle Adjustments / Ajustes del mango

- 1)
- **Step on handle release pedal to change handle position**  
Pise en el pedal de liberación del mango para cambiar la posición del mango

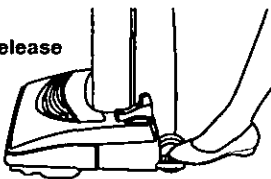

- 2)
- **Move vacuum to upright position for storage and tool use**  
Mueva la aspiradora a la posición vertical para el almacenaje y el uso de las herramientas

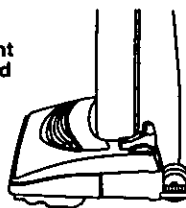

- 3)
- **Move vacuum to middle position for normal use**  
Mueva la aspiradora a la posición mediana para el uso normal

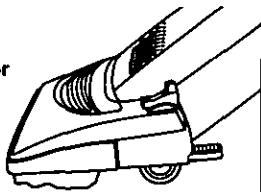

- 4)
- **Use low position for cleaning under furniture**  
La posición baja para limpiar debajo de los muebles

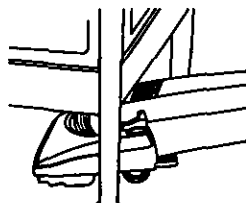

## Using Tools / Uso de herramientas

- **ALWAYS** place carpet-bare floor selector in **BARE FLOOR (TOOLS)** position when using tools  
Al usar las herramientas siempre coloque el selector carpet/bare floor en la posición **BARE FLOORS (TOOLS)**

- **Remove wand from short hose by twisting and pulling up**  
Rodando y levantando hacia arriba quite el tubo de la manguera corta



- **The tools can be attached to hose, wand(s) or crevice tool**  
Se puede conectar las herramientas con la manguera, el tubo(s) o la herramienta de hendiduras

- **DO NOT** overextend your reach with hose as it could tip vacuum  
No extienda demasiado la extensión de la manguera porque puede causar que la aspiradora vuelque

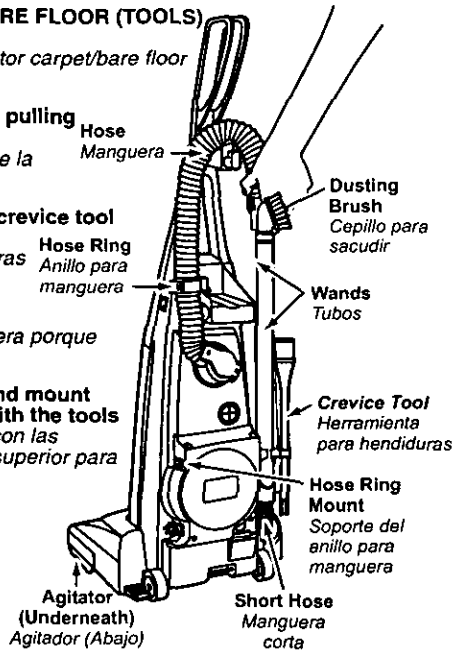
- **To prevent tipping of vacuum, use hose ring and mount when cleaning areas below upper cord hook with the tools**  
Use el anillo de manguera y el soporte al limpiar con las herramientas las áreas bajo del nivel del gancho superior para que la aspiradora no vuelque



## TOOL USE / Uso de herramientas

TOOL / Herramienta	CLEANING AREA / Área para limpiar				
	Furniture / Muebles	Cushions / Cojines	Drapes / Cortinas	Stairs / Escaleras	Walls / Paredes
CREVICE TOOL / Herramienta para hendiduras 	X	X	X	X	X
DUSTING BRUSH / Cepillo para sacudir 	X		X	X	

**Always clean tools before using**  
Siempre limpie las herramientas antes de usarlas

## ROUTINE CARE OF CLEANER

### Cuidado de rutina de la aspiradora

Performing the following tasks will keep your new Panasonic vacuum cleaner operating at peak performance levels and will ensure these high levels for years to come. Check the BEFORE REQUESTING SERVICE section in this manual for recommendations on performing some of these tasks to help solve various problems that may occur.

*Siguiendo las instrucciones dadas, se nueva aspiradora Panasonic funcionará al nivel máximo y continuará funcionando por mucho años en el futuro. Lea la sección "Antes de pedir servicio" en este manual para las recomendaciones para arreglar unos problemas que puedan ocurrir.*

## Cleaning Secondary Foam Filter

### Limpieza del segundo filtro de goma espuma

- > **The secondary foam filter protects the motor**  
*El segundo filtro de goma espuma protege el motor*
- > **Check filter when installing a new dust bag**  
*Al instalar una nueva bolsa de polvo revise el filtro*
- > **If dirty, pull filter from bottom of dust compartment and clean by rinsing in water**  
*Si esté sucio, tire del filtro del fondo del compartimento de polvo y límpielo enjuagando con agua*
- > **When dry, slide filter back into place**  
*Cuando esté seco deslice el filtro a su lugar*
- > **Ensure filter is fully inserted under plastic rib projections**  
*Asegúrese de que el filtro está instalado debajo de las lengüetas plásticas*

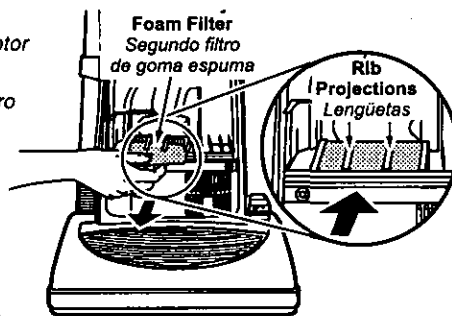

## Replacing HEPA Exhaust Filter

### Cambiar del filtro de escape HEPA

- > **The HEPA exhaust filter removes dirt from recirculated air**  
*El filtro de escape HEPA quita el polvo del aire reciclado*
- > **Check filter when installing a new dust bag**  
*Revise el filtro al instalar una nueva bolsa de polvo*
- > **If dirty, remove filter from bottom of the dust cover by pulling straight up on retainers on frame. Lift one side at a time**  
*Si esté sucio, quite el filtro del fondo de la cubierta de polvo al tirar hacia arriba en las lengüetas del marco. Levante un lado y después el otro lado*
- > **Place new filter in dust cover DO NOT CLEAN WITH WATER\***  
*Coloque el filtro nuevo en la cubierta de polvo No limpie con agua\**
- > **Place filter in frame and install in dust cover, making sure white side is facing down towards dust cover grill**  
*Coloque el filtro en el marco y instale la cubierta de polvo asegurando de que el lado blanco dé hacia arriba*

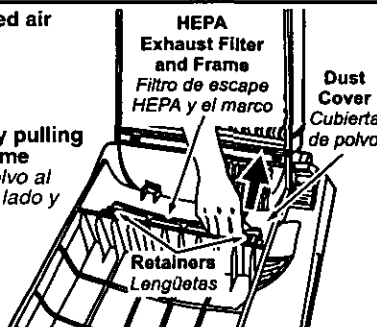

**\*Filter cannot be cleaned and should be replaced at least once each year**  
**\*No se puede limpiar el filtro y se debe cambiarlo a lo menos una vez cada año**

# Changing Dust Bag

## Cambio de la bolsa para polvo

Always operate vacuum with genuine Panasonic Type U3 Standard or U6 Electrostatic dust bags installed. Panasonic dust bags may be purchased through any authorized Panasonic dealer or ordered from service company.

Siempre opere la aspiradora con las bolsas Panasonic Type U3 Standard U6 Electrostatic instaladas. Se puede comprar las bolsas de polvo en cualquier vendedor autorizado Panasonic o mandar de una compañía de servicio

- 1)  
 ➤ Pull outward on dust cover grip to remove the dust cover  
 Empuje hacia afuera en la cubierta de polvo para quitarla

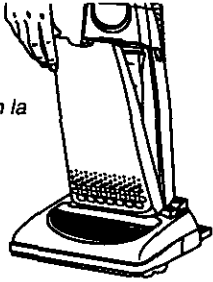

- 2)  
 ➤ Remove dust bag by grasping cardboard portion and pulling out  
 Agarre la parte de cartón de la bolsa y empuje hacia afuera para quitar la bolsa de polvo

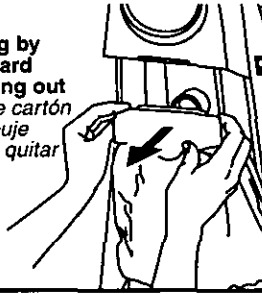

- 3)  
 ➤ Spread out new dust bag, taking care not to tear bag  
 Extienda la nueva bolsa de polvo teniendo cuidado de no romper la bolsa



- 4)  
 ➤ Fold new dust bag to clear slots as shown  
 Doble la nueva bolsa de polvo para que no toque las ranuras como se ve en el diagrama

- Attach new dust bag onto bag holder by holding cardboard portion and pushing back  
 Teniendo la parte de cartón y empujando hacia atrás instale la nueva bolsa de polvo en el soporte para la bolsa

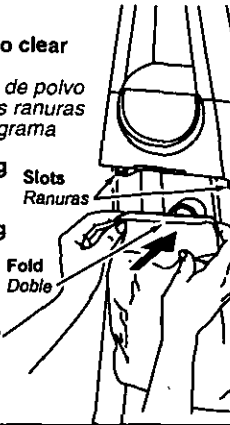

- 5)  
 ➤ Reinsert tabs on end of dust cover into grooves on dust compartment to allow cover to rotate closed  
 Reinstale las lengüetas en el extremo de la cubierta de polvo en las ranuras en el compartimento de polvo para que la cubierta ruéde hasta la posición cerrada

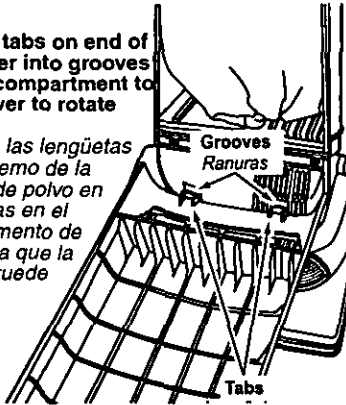

- 6)  
 ➤ Rotate dust cover up into closed position and press into place without pinching dust bag  
 Ruede la cubierta de polvo hasta la posición cerrada y apriétela en su lugar sin apretar la bolsa de polvo

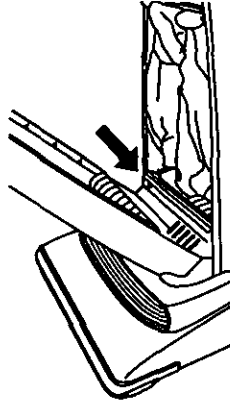

## Removing and Installing Lower Plate

### Quitando e insertando la base inferior

- **Before servicing any parts, disconnect vacuum from electrical outlet**

*Desenchufe la aspiradora de la toma de pared antes de hacerles servicio a las piezas*

- **Always place paper under nozzle anytime lower plate is removed to protect floor**

*Siempre coloque un papel debajo de la boquilla para proteger el suelo cada vez se quita la base inferior*

- **Place handle in upright position and turn vacuum over to expose lower plate**

*Coloque el mango en la posición vertical y vuelque la aspiradora para exponer la base inferior*

- **Release lower plate by removing two (2) screws and pressing inward on two (2) locking tabs**

*Para liberar la base inferior, quite los dos (2) tornillos y apriete hacia adentro en las dos (2) lengüetas de cierre*

- **Remove lower plate and remove any residue that may exist in belt area**

*Quite la base inferior y quite los residuos que exista en el área de la correa*

- **Reinstall lower plate by hooking front end of lower plate into slots on front of nozzle housing**

*Para reinstalar la base inferior, enganche el extremo delantero de la base inferior en las ranuras en el montaje delantero de la boquilla*

- **Make sure all wires are routed properly and not pinched**

*Asegúrese de que las alambres estén dirigidas bien y no estén apretadas*

- **Press lower plate until locking tabs snap into place then replace two (2) screws**

*Apriete la base inferior hasta que las lengüetas hagan clic en su lugar y luego reemplace dos (2) tornillos*

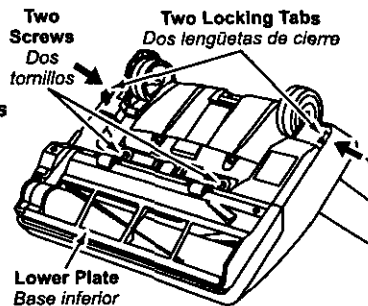

## Replacing Headlight Bulb / Cambio de la bombilla

- **Remove lower plate**

*Quite la base inferior*

- **Grasp the bulb socket assembly and pull upward while moving it back and forth**

*Agarre el casquillo portalámparas y levante al moverlo hacia trasera y delantera*

- **Remove old bulb from the socket by pushing in while turning counterclockwise**

*Quite la bombilla vieja del casquillo portalámparas al empujar hacia adentro y rodar en el sentido contrario de las agujas de reloj al mismo tiempo*

- **Replace bulb by pushing in while turning clockwise**

*Reemplace la bombilla empujando hacia adentro y rodando en el sentido de las agujas de reloj al mismo tiempo*

- **Only use a bulb rated 130 V AC-15 Watts or less**

*Use solamente una bombilla de 130 V AC-15 vatios o de menos voltios*

- **Replace bulb socket assembly into nozzle housing by pushing it back down into slot /**

*Reemplace el casquillo portalámparas en el montaje de boquilla empujándolo hacia abajo en la ranura*

- **Reinstall lower plate**

*Reemplace la base inferior*

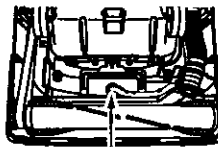

## Replacing Belt / Cambie la correa

- **Replace belt whenever a burning rubber smell caused by excessive slippage occurs**  
*Cambie la correa cuando ocurra un olor de goma que quema causado por un patinaje excesivo*
- **Place carpet-bare floor selector in CARPET position**  
*Mueva el selector carpet-bare floor sin alfombra a la posición CARPET*
- **Remove lower plate**  
*Quite la base inferior*
- **Remove agitator by carefully lifting out**  
*Al levantar con cuidado quite el agitador*
- **Remove worn or broken belt**  
*Quite la correa gastada o rota*
- **If end caps fall off, do not lose the two (2) washers**  
*Si se caen los tapas del extremo, no pierda las dos (2) arandelas*
- **Loop new belt (Panasonic Type UB8 only) around motor shaft and belt pulley; see illustration for correct belt routing**  
*Envuelva la correa nueva (Panasonic Type UB8 solamente) en el eje del motor y la polea de cepillo, véase el diagrama para envolver la correa*
- **Clean agitator and replace the two (2) washers and end caps**  
*Limpie el agitador y cambie las dos (2) arandelas y las tapas del extremo*
- **Reinstall agitator back into nozzle housing grooves**  
*Reinstale el agitador en las ranuras del compartimento de la boquilla*
- **After reinstalling the agitator, turn it by hand to make sure that belt is not twisted or pinched and that all rotating parts turn freely**  
*Después de instalar el agitador, ruede a mano para que asegure que la correa no esté torcida ni apretada y que rueden libremente todas las piezas rodantes*
- **Reinstall lower plate**  
*Reemplace la base inferior*

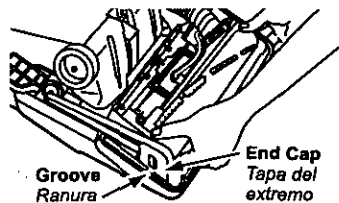
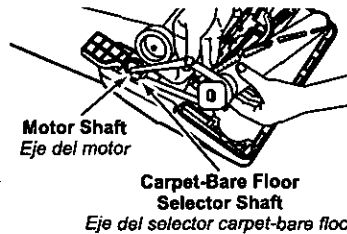
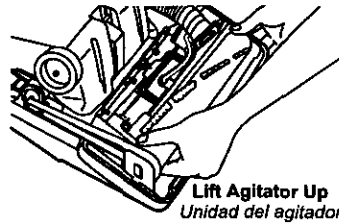

## Cleaning Agitator / Limpieza del agitador

- **Clean agitator after every five uses and every time the belt is replaced**  
*Limpie el agitador después de cada cinco utilizaciones y cada vez que se cambia la correa*
- **Remove lower plate**  
*Quite la base inferior*
- **Cut off any carpet pile and lint entangled around agitator with a pair of scissors**  
*Corte con unas tijeras el pelo de alfombra y la pelusa envueltos en el agitador*
- **Remove agitator**  
*Quite el agitador*
- **Remove any string or debris located on the end caps, washers or agitator shaft**  
*Quite los hilos o los residuos ubicados en los tapas del extremo, en las arandelas o en el eje del agitador*
- **Reinstall agitator and lower plate**  
*Reemplace el agitador y la base inferior*

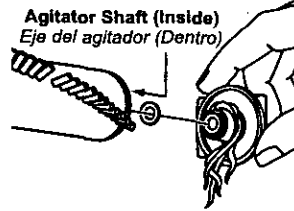
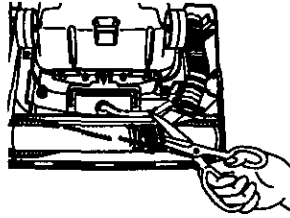

## Replacing Agitator / Cambio del agitador

- **When the bristles on the agitator are worn so that they do not touch a card held across the lower plate, the agitator should be replaced**  
*Cuando las cerdas del cepillo del agitador estén gastadas y no toquen una tarjeta puesta por la base inferior, se debe cambiar el agitador*
- **Remove lower plate and agitator**  
*Quite la base inferior y el agitador*
- **Clean debris from end caps**  
*Limpie los residuos de los tapas del extremo*
- **Position belt over belt pulley on the new brush unit**  
*Coloque la correa sobre la polea de correa en la nueva unidad de cepillo*
- **Reinstall agitator and lower plate**  
*Reemplace el agitador y la base inferior*

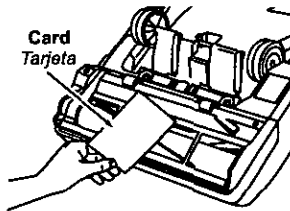

## Agitator Assembly / Montaje de agitador

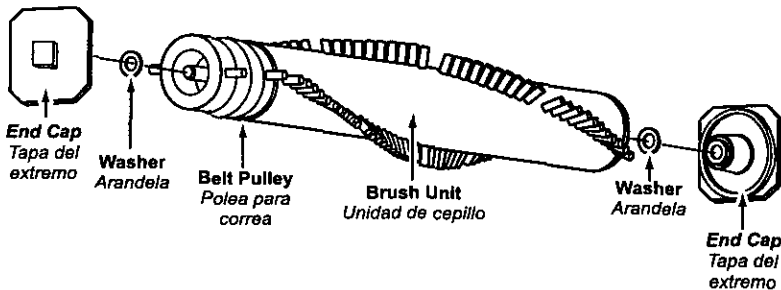

## **Cleaning Exterior and Tools**

### *Limpiando el exterior y las herramientas*

- **Unplug cord from wall outlet**  
*Desenchufe de la toma en la pared*
- **Clean exterior using a clean, soft cloth that has been dipped in a solution of mild liquid detergent and water and wrung dry**  
*Limpie la parte exterior con un trapo suave y limpio que se ha metido en una solución de detergente líquido y agua y se ha escurrido hasta que esté seco*
- **DO NOT drip water on cleaner, wipe dry after cleaning**  
*No deje caer el agua en la aspiradora, seque con un trapo después de limpiarla*
- **DO NOT clean tools in dishwasher or clothes washer**  
*No limpie las herramientas en el lavaplatos ni en la lavadora de ropa*
- **Wash tools in warm soapy water, rinse and air dry**  
*Lave las herramientas en la tibia agua con jabón, enjuague y seque al aire*
- **DO NOT use tools if they are wet**  
*No use las herramientas si están mojados*

## Removing Clogs

### Quitar de los residuos de basura en los conductos

The hose located on the back of the vacuum cleaner carries the dirt from the nozzle up to the dust bag. If the hose should become clogged:

La manguera situada en la parte posterior de la aspiradora lleva el polvo de la boquilla hasta la bolsa de polvo. Si hay residuos en la manguera:

- **Unplug vacuum**  
*Desenchufe la aspiradora*
- **Pull open suction inlet cover and check for clogging**  
*Tire de la cubierta de aspiración y revise por los residuos*
- **Disconnect wand from short hose and check the wand and hose**  
*Desconecte el tubo de la manguera corta y revise por residuos en el tubo y en la manguera*
- **Plug in vacuum cleaner and turn on**  
*Enchufe la aspiradora y enciéndala*
- **Disconnect wand and stretch hose in and out to remove clog**  
*Desconecte el tubo y estire la manguera hasta la extensión máxima y mínima para quitar los residuos*
- **If clog still exists, turn vacuum cleaner OFF and UNPLUG POWER CORD**  
*Si ya hay los residuos, apague la aspiradora y desenchufe el cordón eléctrico*
- **Remove lower plate**  
*Quite la base inferior*
- **Remove short hose from nozzle by lifting straight up**  
*Levante hacia arriba para quitar la manguera corta de la boquilla*
- **Inspect hose end and clear any obstructions**  
*Revise el extremo de la manguera y quite los obstáculos*
- **Reinstall short hose and lower plate**  
*Reemplace la manguera corta y la base inferior*

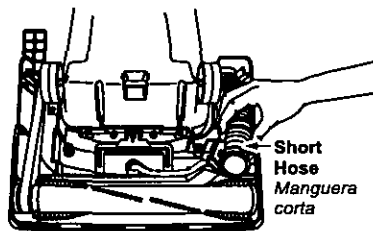
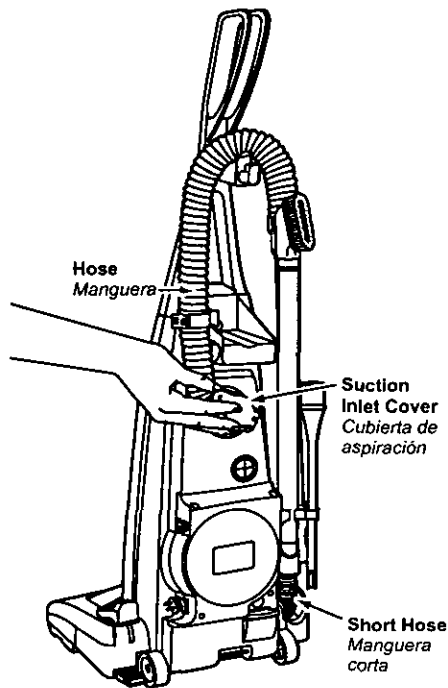

## BEFORE REQUESTING SERVICE



### **WARNING** *Electrical Shock or Personal Injury Hazard.*

*Disconnect the electrical supply before servicing or cleaning the unit. Failure to do so could result in electrical shock or personal injury from cleaner suddenly starting.*

Review this chart to find do-it-yourself solutions for minor performance problems. Any service needed, other than those described in these Operating Instructions, should be performed by an authorized service representative.

PROBLEM	POSSIBLE CAUSE	POSSIBLE SOLUTION
Cleaner will not run.	<ol style="list-style-type: none"> <li>1. Unplugged at wall outlet.</li> <li>2. ON-OFF switch not turned on.</li> <li>3. Tripped circuit breaker/blown fuse at household service panel.</li> </ol>	<ol style="list-style-type: none"> <li>1. Plug in firmly. Push ON-OFF switch to ON.</li> <li>2. Push ON-OFF switch to ON.</li> <li>3. Reset circuit breaker or replace fuse.</li> </ol>
Poor job of dirt pickup.	<ol style="list-style-type: none"> <li>1. Full or clogged dust bag.</li> <li>2. Broken belt.</li> <li>3. Carpet-bare floor setting incorrect.</li> <li>4. Clogged hose or nozzle.</li> <li>5. Hose not inserted fully.</li> <li>6. Worn agitator.</li> <li>7. Hole in hose.</li> <li>8. Dust cover improperly installed.</li> <li>9. Belt not installed on motor shaft.</li> </ol>	<ol style="list-style-type: none"> <li>1. Change bag.</li> <li>2. Replace belt.</li> <li>3. Set in the correct position.</li> <li>4. Clean hose or nozzle area.</li> <li>5. Insert hose.</li> <li>6. Replace agitator.</li> <li>7. Replace hose.</li> <li>8. Properly install dust cover.</li> <li>9. Install belt on motor shaft.</li> </ol>
Bare floor option will not work.	<ol style="list-style-type: none"> <li>1. Belt improperly installed with bare floor selector in wrong position.</li> </ol>	<ol style="list-style-type: none"> <li>1. Properly install belt.</li> </ol>
Dust escapes the paper bag.	<ol style="list-style-type: none"> <li>1. Bag improperly installed.</li> <li>2. Bag torn.</li> </ol>	<ol style="list-style-type: none"> <li>1. Properly install bag.</li> <li>2. Replace bag.</li> </ol>
Light will not work.	<ol style="list-style-type: none"> <li>1. Burned out light bulb.</li> </ol>	<ol style="list-style-type: none"> <li>1. Replace light bulb.</li> </ol>

# WARRANTY

## Panasonic Vacuum Cleaner Limited Warranty

Panasonic Home and Commercial Products Company (collectively referred to as "the warrantor") will repair this product with new or refurbished parts free of charge, in the U.S.A. or Puerto Rico for one (1) year from the date of original purchase in the event of a defect in materials or workmanship.

**This Limited Warranty Excludes both Labor and Parts for the following items which require normal replacement:** Disposable Dust Bag, Filters, Belts, Light Bulbs, Agitator Brushes and Batteries (if supplied).

Carry-in or mail-in service in the U.S.A. can be obtained during the warranty period by contacting a Panasonic Services Company (PASC) Factory Servicenter listed in the Servicenter Directory. Or call, toll free, 1-800-211-PANA (7262) to locate a PASC Authorized Servicenter. Carry-in or mail-in service in Puerto Rico can be obtained during the warranty period by calling the local Panasonic Sales Company telephone number listed in the Servicenter Directory.

This warranty is extended only to the original purchaser. A purchase receipt or other proof of date of original purchase will be required before warranty performance is rendered.

This warranty only covers failures due to defects in materials and workmanship which occur during normal use and does not cover damages which occur in shipment, or failures which are caused by products not supplied by the warrantor, or failures which result from accident, misuse, abuse, neglect, mishandling, misapplication, faulty installation, improper operation or maintenance, alteration, modification, power line surge, improper voltage supply, lightning damage, commercial use such as hotel, office, restaurant or other business or rental use of the product, or service by anyone other than a PASC Authorized Servicenter, or damage that is attributable to acts of God.

### **LIMITS AND EXCLUSIONS:**

There are no express warranties except as listed above.  
THE WARRANTOR SHALL NOT BE LIABLE FOR INCIDENTAL OR CONSEQUENTIAL DAMAGES RESULTING FROM THE USE OF THIS PRODUCT, OR ARISING OUT OF ANY BREACH OF THIS WARRANTY. ALL EXPRESS AND IMPLIED WARRANTIES, INCLUDING THE WARRANTIES OF MERCHANTABILITY AND FITNESS FOR A PARTICULAR PURPOSE, ARE LIMITED TO THE APPLICABLE WARRANTY PERIOD SET FORTH ABOVE.

Some states do not allow the exclusion or limitation of incidental or consequential damages, or limitations on how long an implied warranty lasts, so the above exclusions or limitations may not apply to you.

This warranty gives you specific legal rights and you may also have other rights which vary from state to state. If a problem with this product develops during or after the warranty period, you may contact your dealer or Servicenter. If the problem is not handled to your satisfaction, then write to the Consumer Affairs Department at the listed address on the back cover.

# WHAT TO DO WHEN SERVICE IS NEEDED

## *Cuando necesita servicio*

If your Panasonic Vacuum Cleaner needs service, look in the yellow pages of the telephone book under HOME APPLIANCE SERVICE for your nearest Panasonic Services Company ("PASC") Factory Servicenter, or PASC authorized Servicenter, or call, 1-800-211-PANA (7262) toll free to find a convenient servicer. **DO NOT send the product to the Executive or Regional Sales offices. They are NOT equipped to make repairs.**

*Si su aspiradora Panasonic necesita servicio, busque el Centro de Servicio Panasonic o un Centro de Servicio PASC autorizado más cercano bajo "Servicio de Electrodomésticos" en las páginas amarillas de la guía de teléfonos o llame gratis al 1-800-211-PANA (7262) para encontrar un centro de servicio conveniente. **No mande el producto a las Executive o Regional Sales Offices. No están equipadas para arreglar estos productos.***

### If you ship the product

Carefully pack and send it prepaid, adequately insured and preferably in the original carton. Attach a postage-paid letter to the outside of the carton, which contains a description of your complaint. **DO NOT send the product to the Executive or Regional Sales Offices. They are NOT equipped to make repairs.**

### *Si manda el producto*

*Empaquete con cuidado en el cartón original si posible y mándelo prepagado y con seguro suficiente. Ponga una carta con sellos en la que describe su problema con el producto en el exterior del cartón. **No mande el producto a las Executive o Regional Sales Offices. No están equipadas para arreglar estos productos.***

### Customer's Record / *Récord de Comprador*

Model No. \_\_\_\_\_ Dealer's Name \_\_\_\_\_  
*Número de Modelo* \_\_\_\_\_ *Nombre del Vendedor* \_\_\_\_\_

Serial No. / *Número de Serie* \_\_\_\_\_

Dealer's Address / *Dirección del Vendedor* \_\_\_\_\_

Date of Purchase / *Fecha de Compra* \_\_\_\_\_

PANASONIC HOME & COMMERCIAL PRODUCTS  
COMPANY, DIVISION OF MATSUSHITA ELECTRIC  
CORPORATION OF AMERICA

One Panasonic Way  
Secaucus, New Jersey 07094  
World Wide Web Address  
<http://www.panasonic.com>

AC01ZBVEZ0U  
C01ZBVE00U00

PANASONIC SALES COMPANY,  
MATSUSHITA ELECTRIC OF  
PUERTO RICO INC.

Ave. 65 de infantería, Km 9.5  
San Gabriel Industrial Park  
Carolina, Puerto Rico 00985

Printed in Mexico  
*Impreso en Mexico*