

Panasonic®

VACUUM CLEANER
Aspirateur
Aspiradora

MC-V7312

Operating Instructions

Manuel d'utilisation
Instrucciones de operación

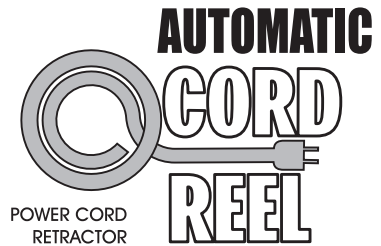
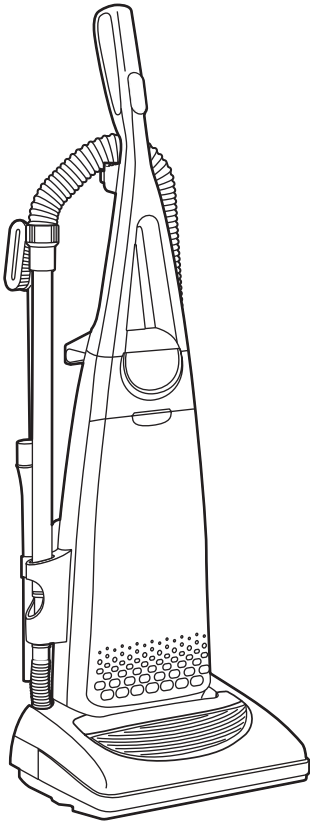

Before operating your vacuum cleaner, please read these instructions completely.

Avant d'utiliser l'appareil, il est recommandé de lire attentivement ce manuel.

Antes de usar su aspiradora, lea completamente estas instrucciones por favor.

C01ZBZE00000

CONSUMER INFORMATION

Please read **IMPORTANT SAFETY INSTRUCTIONS** on page 5 before use. Read and understand all instructions.

TO OUR VALUED CUSTOMER

We are very pleased to welcome you to the Panasonic family of products. Thank you for purchasing this product. Our intent is that you become one of our many satisfied customers.

Proper assembly and safe use of your vacuum cleaner are your responsibilities. Your vacuum cleaner is intended only for household use. The cleaner should be stored in a dry, indoor area. Read the Operating Instructions carefully for important use and safety information.

Special care is required when vacuuming certain types of carpet or floor covering. Always check the carpet or floor covering manufacturer's recommended cleaning instructions before vacuuming.

PLEASE PAY CLOSE ATTENTION TO ALL WARNING AND CAUTION STATEMENTS.



WARNING

WARNING statements are designed to alert you to the possibility of personal injury, loss of human life, and/or damage to the vacuum cleaner and/or personal property if the instructions given are not followed.



CAUTION

CAUTION statements are designed to alert you to the possibility of damage to the vacuum cleaner and/or personal property if the instructions given are not followed.



WARNING

TO AVOID ELECTRICAL SHOCK

Never vacuum damp or wet surfaces or liquids.
DO NOT store machine outdoors.
Replace worn or frayed power cord immediately.
Unplug from outlet when not in use and before servicing.

TO AVOID ACCIDENTS

Except for hand-held cleaners, keep machine on floor - not chairs, tables, steps, stairs, etc.
Store machine promptly after each use to prevent accidents such as tripping over power cord or machine.
Use machine and accessories only in a manner intended by the manufacturer.
The use of an extension cord is not recommended.

IMPORTANT SAFETY INSTRUCTIONS

When using vacuum cleaner, basic precautions should always be followed, including the following:

READ ALL INSTRUCTIONS BEFORE USING THIS VACUUM CLEANER



WARNING

To reduce the risk of fire, electrical shock, injury:

1. **DO NOT** leave vacuum cleaner plugged in. Unplug from outlet when not in use and before servicing.
2. To reduce the risk of fire or electric shock - **DO NOT** use outdoors or on wet surfaces.
3. **DO NOT** allow to be used as a toy. Close attention is necessary when used by or near children.
4. Use only as described in this manual. Use only manufacturer's recommended tools.
5. **DO NOT** use with damaged cord or plug. If vacuum cleaner is not working as it should, has been dropped, damaged, left outdoors, or dropped into water, return it to an authorized Panasonic Servicenter.
6. **DO NOT** pull or carry by cord, use cord as a handle, close door on cord, or pull cord around sharp edges or corners. **DO NOT** run vacuum cleaner over cord. Keep cord away from heated surfaces.
7. **DO NOT** unplug by pulling on cord. To unplug, grasp the plug, not the cord.
8. **DO NOT** handle plug or vacuum cleaner with wet hands.
9. **DO NOT** put any objects into openings. **DO NOT** use with any opening blocked; keep free of dust, lint, hair, and anything that may reduce air flow.
10. Keep hair, loose clothing, fingers, and all parts of body away from openings and moving parts.
11. **DO NOT** pick up anything that is burning or smoking, such as cigarettes, matches, or hot ashes.
12. **DO NOT** use without dust bag and/or filters in place.
13. Turn off all controls before unplugging.
14. Use extra care when cleaning on stairs.
15. **DO NOT** use cleaner to pick up flammable or combustible liquids such as gasoline or use in areas where they may be present.
16. **DO NOT** operate cleaner without belt cover properly installed.

SAVE THESE INSTRUCTIONS THIS VACUUM CLEANER IS INTENDED FOR HOUSEHOLD USE ONLY

Note: Before you plug in your Panasonic vacuum cleaner, make sure that the voltage indicated on the rating plate located at the back of the vacuum cleaner is the same as your local supply.

TABLE OF CONTENTS

CONSUMER INFORMATION	2
IMPORTANT SAFETY INSTRUCTIONS	5
PARTS IDENTIFICATION	10
FEATURE CHART	11
ASSEMBLY	12
Attaching Handle	12
Using Cord Reel	12
Tool Storage	14
FEATURES	16
Automatic Self Adjusting Nozzle	16
Edge Cleaning	16
Motor Protector	16
Carpet-Bare Floor Selector	18
Hose Ring and Hose Ring Mount	20
TO OPERATE CLEANER	22
Power Cord	22
ON-OFF Switch	22
Handle Adjustments	22
Using Tools	24
ROUTINE CARE OF CLEANER	26
Cleaning Secondary Foam Filter	26
Replacing HEPA Exhaust Filter	26
Changing Dust Bag	28
Removing and Installing Lower Plate	30
Replacing Headlight Bulb	32
Replacing Belt	34
Cleaning Agitator	36
Replacing Agitator	36
Agitator Assembly	36
Cleaning Exterior and Tools	38
Removing Clogs	40
BEFORE REQUESTING SERVICE	42
WARRANTY	45,46
WHAT TO DO WHEN SERVICE IS NEEDED	back cover

PARTS IDENTIFICATION

Identificación de piezas

Nomenclature

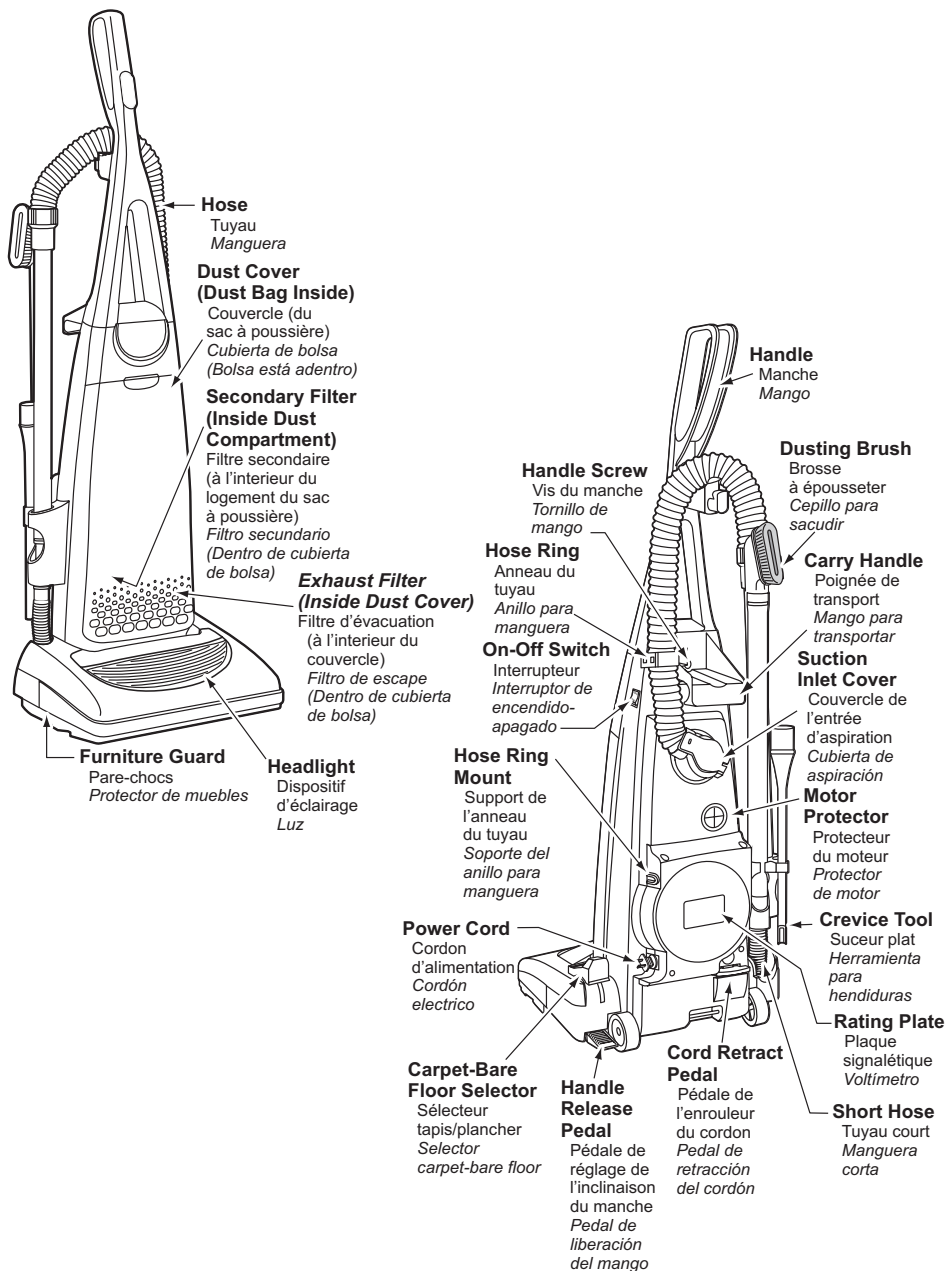

FEATURE CHART

Power	Cord Reel	Headlight	Cord Length	Bare Floor
120V AC(60Hz)	Yes	Yes	28 Ft (8 m)	Yes

Tableau des caractéristiques

Alimentation	Enrouleur de cordon	Dispositif d'éclairage	Longueur du cordon	Position plancher
120 V c.a. (60 Hz)	Oui	Oui	8 m (28 pi)	Oui

Diagrama de características

<i>Voltaje</i>	<i>Mecanismo de enrollar el cordón</i>	<i>Luz</i>	<i>Extensión de cordón</i>	<i>Uso sin alfombra</i>
12.0 A/12,0 A	Si	Si	8 m (28 pi)	Si

ASSEMBLY

Attaching Handle

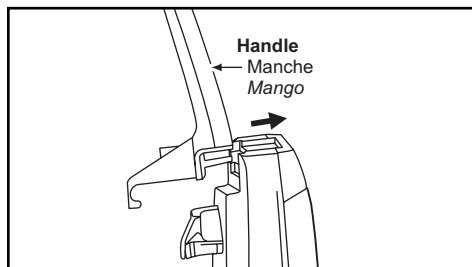

- 1)
 - **DO NOT** plug in until assembly is complete.
 - Turn ON-OFF switch OFF.
 - Remove handle screw.
 - Insert handle.

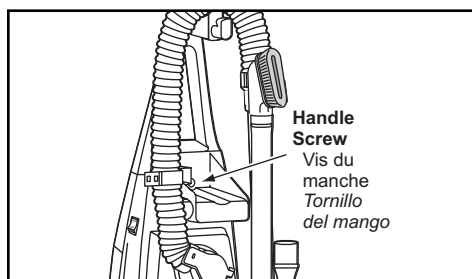

- 2)
 - Insert screw.
 - Tighten screw.

Using Cord Reel

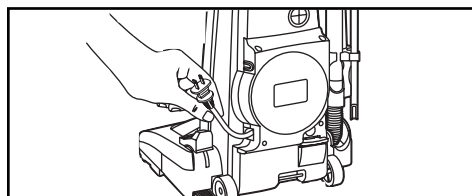

- Pull cord out of cord reel until the end is reached.
- Do not use vacuum without cord pulled out all the way.

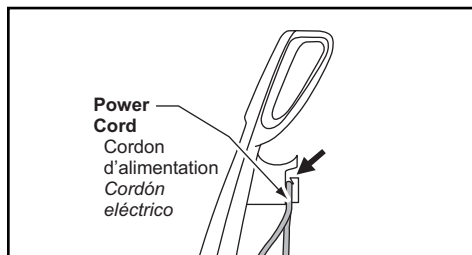

- Push power cord into two (2) cord clips in back of handle.
- Plug the polarized power cord into a 120V outlet located near floor.

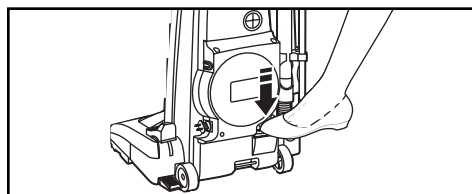

- To prevent injury or damage, hold plug head while rewinding cord.
- Push cord retract pedal down to rewind.

Tool Storage

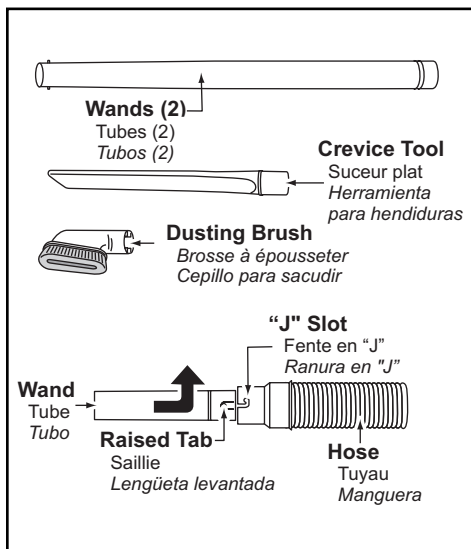

- Some tools may already be stored on vacuum cleaner.
- Place hose in back of handle on hose holder.
- Attach wand to hose by aligning the two (2) raised tabs on wand with "J" slots in hose, guide tabs along grooves, twist to lock in place.
- Place wand in rear slot of tool holder, twisting and pushing down over short hose to assure a good connection.
- Store other wand, with dusting brush on top, in round rear slot of tool holder.
- Place crevice tool into front slot of tool holder.

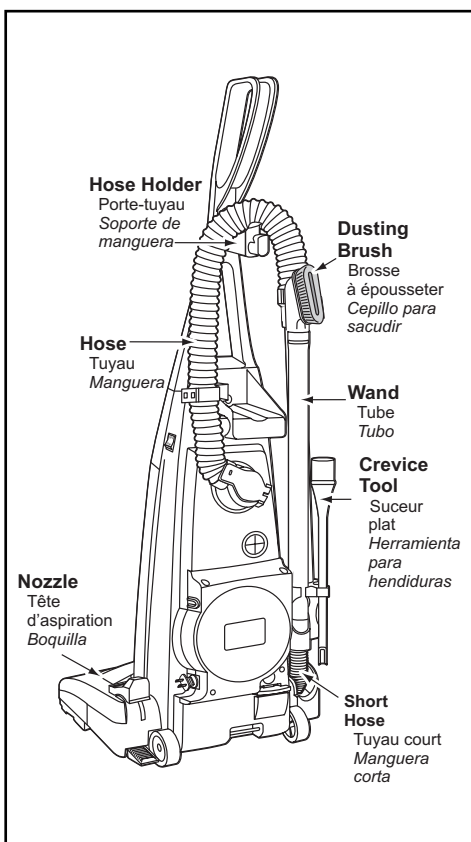

FEATURES

Automatic Self Adjusting Nozzle

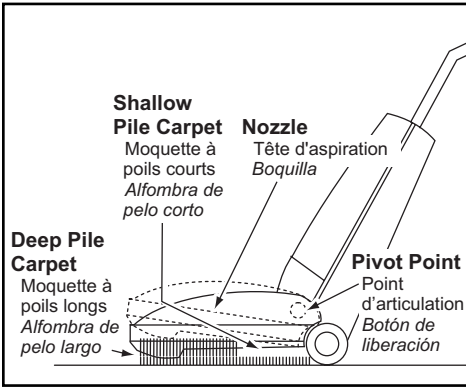

- The nozzle of your Panasonic upright vacuum cleaner automatically adjusts to any carpet pile height.
- Feature allows nozzle to float evenly over carpet pile surfaces.
- No manual adjustments required.

Edge Cleaning

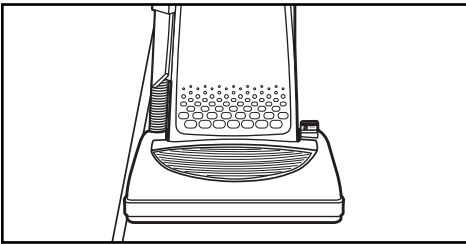

- Edge cleaning feature provides for improved cleaning of carpets near walls and furniture.

Motor Protector

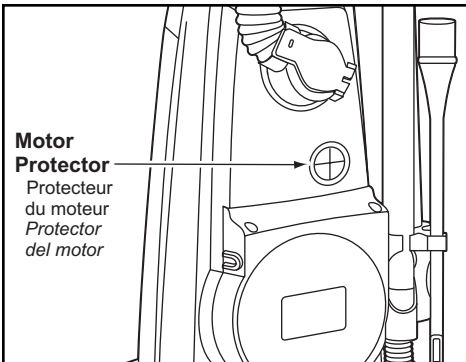

- Automatically opens to provide cooling air to the motor when a clog occurs or when dust bag needs changing.
- Motor protector may open when using tools.
- Check operation by placing hand over end of hose.
- If motor protector opens, the vacuum will make a slightly different sound.
- Do not block motor protector.

Carpet-Bare Floor Selector

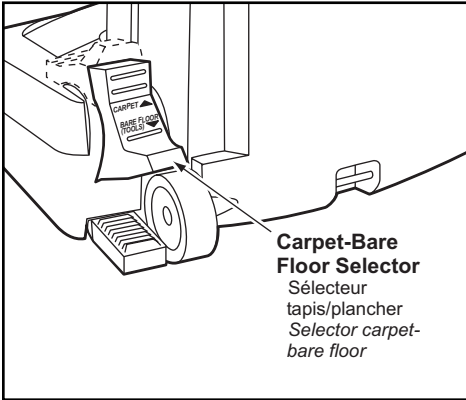

- Selector should be placed in **BARE FLOOR (TOOLS)** position when using cleaner on bare floors and when using tools.
- The agitator does not rotate in the **BARE FLOOR (TOOLS)** position.
- Selector should be placed in **CARPET** position when using cleaner on carpeted floors.
- For longer belt life, turn vacuum off before moving selector.



- Otherwise, take care when selecting either position to ensure selector is pushed as **fully and quickly** as possible to desired position.
- Failure to do so can cause belt to rub on selector shaft and result in belt becoming hot and creating a burning rubber smell.

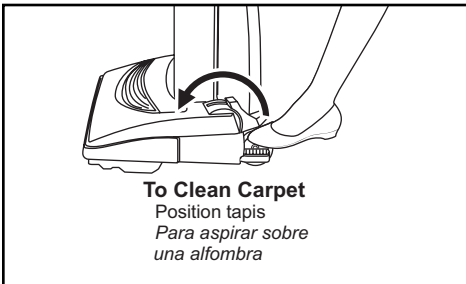

Hose Ring and Hose Ring Mount

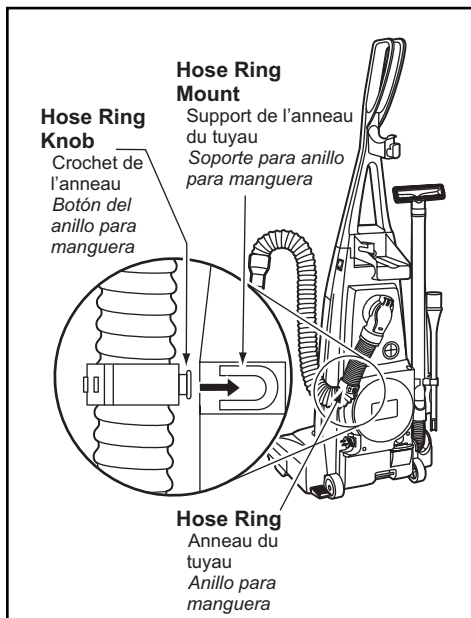

- Hose ring and hose ring mount are designed to prevent tipping of vacuum while using tools.
- Place hose ring in hose ring mount as shown in illustration.

TO OPERATE CLEANER

Power Cord

Note: To reduce the risk of electrical shock, this vacuum has a polarized plug, one blade is wider than the other. This plug will fit in a polarized outlet only one way. If the plug does not fit fully in the outlet, reverse the plug. If it still does not fit, contact a qualified electrician to install the proper outlet. **DO NOT CHANGE THE PLUG IN ANY WAY.** Only use outlets near the floor.

ON-OFF Switch

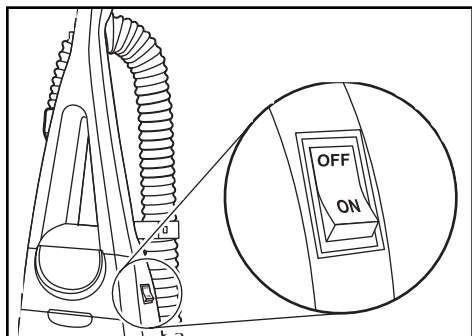

- Ensure ON-OFF switch is OFF.
- Plug the power cord into 120V outlet.
- ON position turns vacuum on.
- OFF position turns vacuum off.

Handle Adjustments

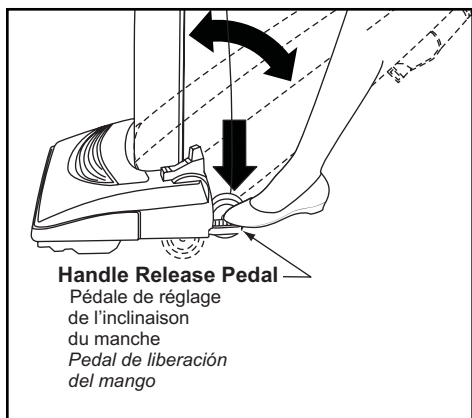

- Step on handle release pedal to change handle position.
- Move vacuum to upright position for storage and tool use.
- Move vacuum to middle position for normal use.
- Use low position for cleaning under furniture.

Using Tools

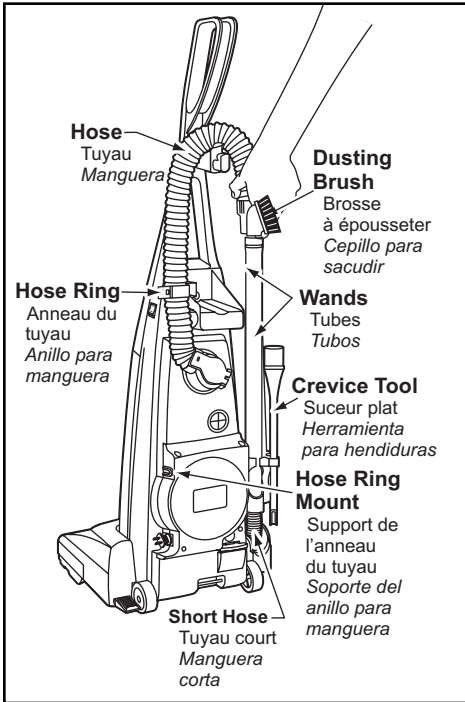

- **ALWAYS** place Carpet-Bare Floor selector in Bare Floor (tools) position when using tools.
- Remove wand from short hose by twisting and pulling up.
- The tools can be attached to hose, wand(s) or crevice tool.
- **DO NOT** overextend your reach with hose as it could tip vacuum.
- To prevent tipping of vacuum, use hose ring mount when cleaning areas below upper cord hook with the tools.

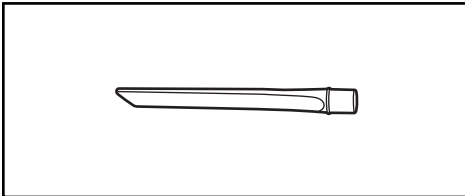

- The Crevice Tool may be used on the following items:
 - Furniture
 - Cushions
 - Drapes
 - Stairs
 - Walls

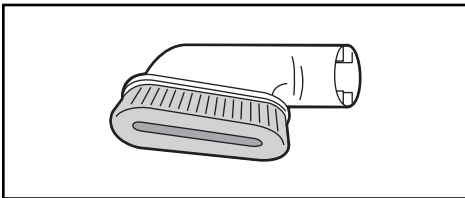

- The Dusting Brush may be used on the following items:
 - Furniture
 - Drapes
 - Stairs
 - Walls

Note: Always clean tools before using.

ROUTINE CARE OF CLEANER

Performing the following tasks will keep your new Panasonic vacuum cleaner operating at peak performance levels and will ensure these high levels for years to come. Check the **BEFORE REQUESTING SERVICE** section in this manual for recommendations on performing some of these tasks to help solve various problems that may occur.

Cleaning Secondary Foam Filter

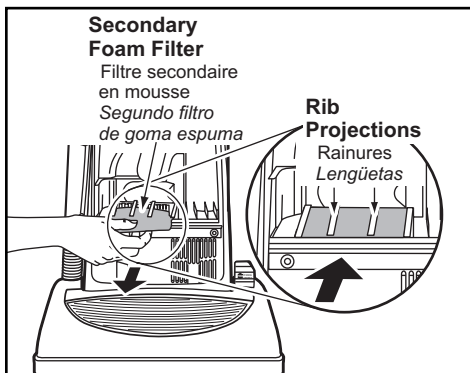

- The secondary foam filter protects the motor.
- Check filter when installing a new dust bag.
- If dirty, pull filter from bottom of dust compartment and clean by rinsing in water.
- When dry, slide filter back into place.
- Ensure filter is fully inserted under plastic rib projections.

Replacing HEPA Exhaust Filter

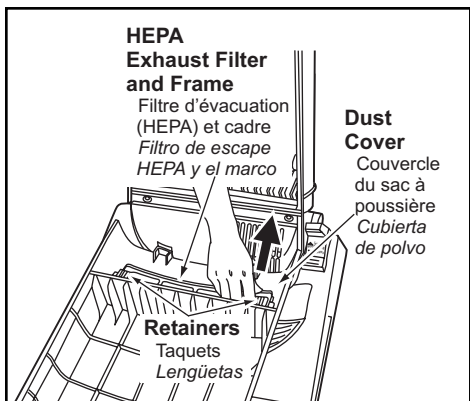

- The HEPA exhaust filter removes dirt from recirculated air.
- Check filter when installing a new dust bag.
- If dirty, remove filter from bottom of the dust cover by pulling straight up on retainers on frame. Lift one side at a time.
- Place new filter in dust cover **DO NOT CLEAN WITH WATER***
- Place filter in frame and install in dust cover. For proper operation the white side must face dust cover grill.

*Filter cannot be cleaned and should be replaced at least once each year.

Changing Dust Bag

Always operate vacuum with genuine Panasonic Type U3 Standard or U6 Electrostatic dust bags installed. Panasonic dust bags may be purchased through any authorized Panasonic dealer or ordered from service company.

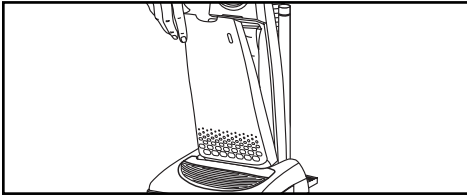

- 1)
➤ Pull outward on dust cover grip to remove the dust cover.

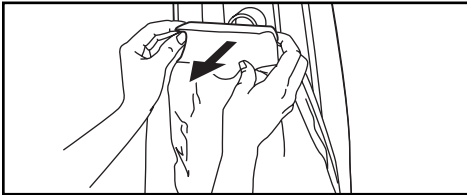

- 2)
➤ Remove dust bag by grasping cardboard portion and pulling out.

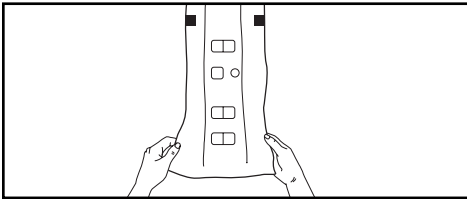

- 3)
➤ Spread out new dust bag, taking care not to tear bag.



- 4)
➤ Fold new dust bag to clear slots as shown.

➤ Attach new dust bag onto bag holder by holding cardboard portion and pushing back.

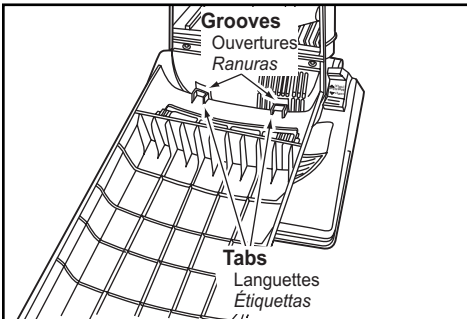

- 5)
➤ Reinsert tabs on end of dust cover into grooves on dust compartment to allow cover to rotate closed.

6)
➤ Rotate dust cover up into closed position and press into place without pinching dust bag.



WARNING *Electrical Shock or Personal Injury Hazard.*

Disconnect the electrical supply before servicing or cleaning the unit. Failure to do so could result in electrical shock or personal injury from cleaner suddenly starting.

Removing and Installing Lower Plate

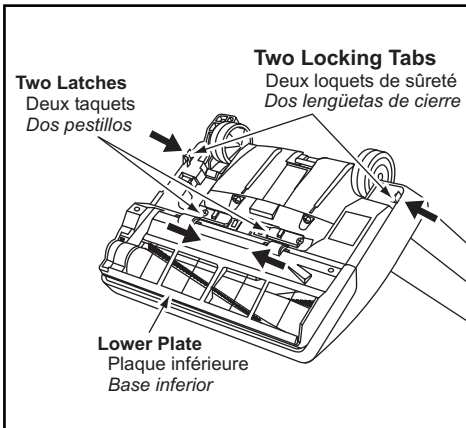

- **Before servicing any parts, disconnect vacuum from electrical outlet.**
- **Always place paper under nozzle whenever lower plate is removed to protect floor.**
- **Place handle in upright position and turn vacuum over to expose lower plate.**
- **Release lower plate by pressing two (2) latches and two (2) locking tabs inward as shown.**
- **Remove lower plate and remove any residue that may exist in belt area.**
- **Reinstall lower plate by hooking front end of lower plate into slots on front of nozzle housing.**
- **Make sure all wires are routed properly and not pinched.**
- **Press lower plate until locking tabs snap into place then push the two (2) latches outward.**

Replacing Headlight Bulb

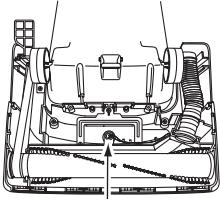

Bulb Socket Assembly
Assemblage de la lampe
Casquillo portalámparas

- Remove lower plate.
- Grasp the bulb socket and pull upward while moving it back and forth.
- Remove old bulb from the socket by pushing in while turning counter-clockwise.
- Replace bulb by pushing in while turning clockwise.
- Only use a bulb rated 130 Volts AC-15 Watts or less.
- Reinstall bulb socket into nozzle housing by pushing it back down into slot.
- Reinstall lower plate.

Replacing Belt

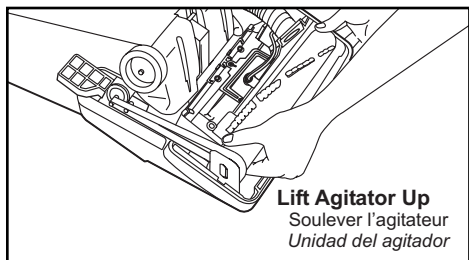

- Replace belt whenever a burning rubber smell caused by excessive slippage occurs.
- Place carpet-bare floor selector in CARPET position.
- Remove lower plate.
- Remove agitator by carefully lifting out.

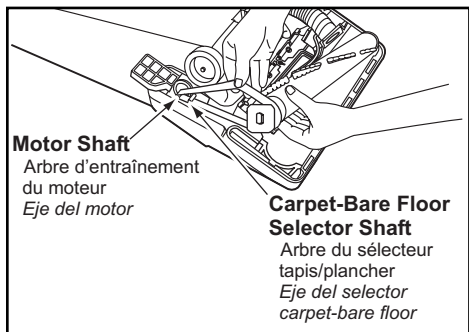

- Remove worn or broken belt.
- Clean agitator and reinstall the two (2) end caps.
- Loop new belt (Panasonic Type UB8 only) around motor shaft and brush pulley; see illustration for correct belt routing.
- Reinstall agitator back into nozzle housing grooves.

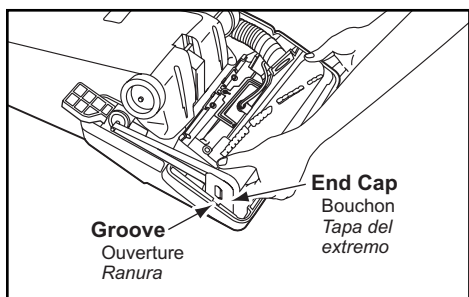

- After reinstalling the agitator, turn it by hand to make sure that belt is not twisted or pinched and that all rotating parts turn freely.
- Reinstall lower plate.

Cleaning Agitator

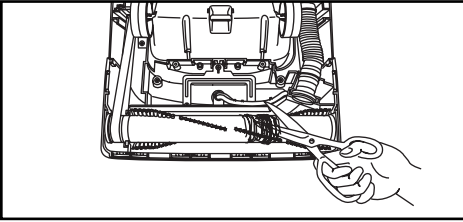

- Clean agitator after every five uses and every time the belt is replaced.
- Remove lower plate.
- Cut off any carpet pile and lint entangled around agitator with a pair of scissors.
- Remove agitator.
- Remove any string or debris located on the end caps or ball bearings.
- Reinstall agitator and lower plate.

Replacing Agitator

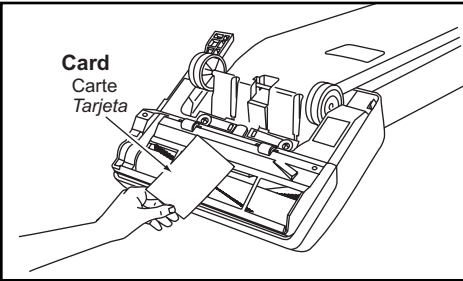

- When the bristles on the agitator are worn so that they do not touch a card held across the lower plate, the agitator should be replaced.
- Remove lower plate and agitator.
- Position belt over belt pulley on the new brush unit.
- Reinstall agitator and lower plate.

Agitator Assembly

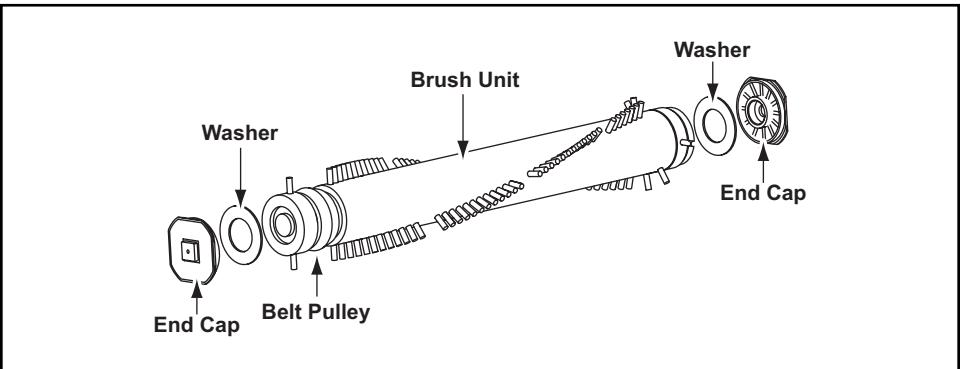

Cleaning Exterior and Tools

- Unplug cord from wall outlet.
- Clean exterior using a clean, soft cloth that has been dipped in a solution of mild liquid detergent and water and wrung dry.
- DO NOT drip water on cleaner and wipe dry after cleaning.
- DO NOT clean tools in dishwasher or clothes washer.
- Wash tools in warm soapy water, rinse and air dry.
- DO NOT use tools if they are wet.

Removing Clogs

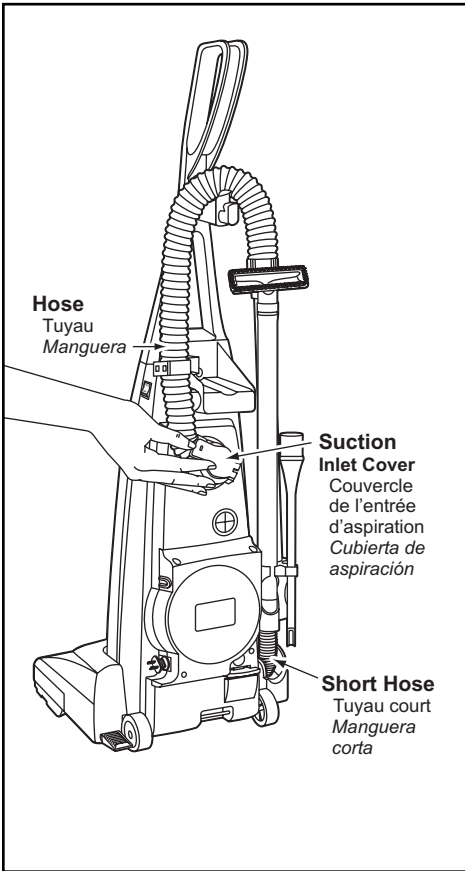

The hose located on the back of the vacuum cleaner carries the dirt from the nozzle up to the dust bag. If the hose should become clogged:

- **Unplug vacuum.**
- **Pull open suction inlet cover and check for clogging.**
- **Disconnect wand from short hose and check the wand and hose.**
- **Plug in vacuum cleaner and turn on.**
- **Disconnect wand and stretch hose in and out to remove clog.**
- **If clog still exists, turn vacuum cleaner OFF and UNPLUG POWER CORD.**
- **Turn vacuum over and inspect agitator area for clogs.**

BEFORE REQUESTING SERVICE



WARNING *Electric Shock or Personal Injury Hazard.*

Disconnect the electrical supply before servicing or cleaning the unit. Failure to do so could result in electric shock or personal injury from cleaner suddenly starting.

Review this chart to find do-it-yourself solutions for minor performance problems. Any service needed, other than those described in these Operating Instructions, should be performed by an authorized service representative.

PROBLEM	POSSIBLE CAUSE	POSSIBLE SOLUTION
Cleaner will not run.	<ol style="list-style-type: none"> 1. Unplugged at wall outlet. 2. ON-OFF switch not turned on. 3. Tripped circuit breaker/blown fuse at household service panel. 	<ol style="list-style-type: none"> 1. Plug in firmly. Push ON-OFF switch to On. 2. Push ON-OFF switch to ON. 3. Reset circuit breaker or replace fuse.
Poor job of dirt pickup.	<ol style="list-style-type: none"> 1. Full or clogged dust bag. 2. Broken belt. 3. Clogged hose or nozzle. 4. Hose not inserted fully. 5. Worn agitator. 6. Hole in hose. 7. Dust cover improperly installed. 	<ol style="list-style-type: none"> 1. Change bag. 2. Replace belt. 3. Clean hose or nozzle area. 4. Insert hose. 5. Replace agitator. 6. Replace hose. 7. Properly install dust cover.
Dust escapes the paper bag.	<ol style="list-style-type: none"> 1. Bag improperly installed. 2. Bag torn. 	<ol style="list-style-type: none"> 1. Properly install bag. 2. Replace bag.

WARRANTY

Panasonic Vacuum Cleaner Limited Warranty

Panasonic Consumer Electronics Company (collectively referred to as "the warrantor") will repair this product with new or refurbished parts free of charge, in the U.S.A. or Puerto Rico for one (1) year from the date of original purchase in the event of a defect in materials or workmanship.

This Limited Warranty Excludes both Labor and Parts for the following items which require normal replacement: Disposable Dust Bag, Filters, Belts, Light Bulbs, Agitator Brushes and Batteries (if supplied).

Carry-in or mail-in service in the U.S.A. can be obtained during the warranty period by contacting a Panasonic Services Company (PASC) Factory Servicenter listed in the Servicenter Directory. Or call, toll free, 1-800-211-PANA (7262) to locate a PASC Authorized Servicenter. Carry-in or mail-in service in Puerto Rico can be obtained during the warranty period by calling the local Panasonic Sales Company telephone number listed in the Servicenter Directory.

This warranty is extended only to the original purchaser. A purchase receipt or other proof of date of original purchase will be required before warranty performance is rendered.

This warranty only covers failures due to defects in materials and workmanship which occur during normal use and does not cover damages which occur in shipment, or failures which are caused by products not supplied by the warrantor, or failures which result from accident, misuse, abuse, neglect, mishandling, misapplication, faulty installation, improper operation or maintenance, alteration, modification, power line surge, improper voltage supply, lightning damage, commercial use such as hotel, office, restaurant or other business or rental use of the product, or service by anyone other than a PASC Authorized Servicenter, or damage that is attributable to acts of God.

LIMITS AND EXCLUSIONS:

There are no express warranties except as listed above.

THE WARRANTOR SHALL NOT BE LIABLE FOR INCIDENTAL OR CONSEQUENTIAL DAMAGES RESULTING FROM THE USE OF THIS PRODUCT, OR ARISING OUT OF ANY BREACH OF THIS WARRANTY. ALL EXPRESS AND IMPLIED WARRANTIES, INCLUDING THE WARRANTIES OF MERCHANTABILITY AND FITNESS FOR A PARTICULAR PURPOSE, ARE LIMITED TO THE APPLICABLE WARRANTY PERIOD SET FORTH ABOVE.

Some states do not allow the exclusion or limitation of incidental or consequential damages, or limitations on how long an implied warranty lasts, so the above exclusions or limitations may not apply to you.

This warranty gives you specific legal rights and you may also have other rights which vary from state to state. If a problem with this product develops during or after the warranty period, you may contact your dealer or Servicenter. If the problem is not handled to your satisfaction, then write to the Consumer Affairs Department at the listed address on the back cover.

WARRANTY

Panasonic Canada Inc.
5770 Ambler Drive, Mississauga, Ontario L4W 2T3

PANASONIC PRODUCT - LIMITED WARRANTY

Panasonic Canada Inc. warrants this product to be free from defects in material and workmanship and agrees to remedy any such defect for a period as stated below from the date of original purchase.

Vacuum Cleaner - One (1) year, parts and labour

LIMITATIONS AND EXCLUSIONS

This warranty does not apply to products purchased outside Canada or to any product which has been improperly installed, subjected to usage for which the product was not designed, misused or abused, damaged during shipping, or which has been altered or repaired in any way that affects the reliability or detracts from the performance, nor does it cover any product which is used commercially. Parts such as disposable dust bags, filters, belts, light bulbs and agitator brushes are also excluded from coverage under this warranty.

This warranty is extended to the original end user purchaser only. A purchase receipt or other proof of date of original purchase is required before warranty service is performed.

THIS EXPRESS, LIMITED WARRANTY IS IN LIEU OF ALL OTHER WARRANTIES, EXPRESS OR IMPLIED, EXCLUDING ANY IMPLIED WARRANTIES OF MERCHANTABILITY OR FITNESS FOR A PARTICULAR PURPOSE. IN NO EVENT WILL PANASONIC CANADA INC. BE LIABLE FOR ANY SPECIAL, INDIRECT OR CONSEQUENTIAL DAMAGES.

In certain instances, some jurisdictions do not allow the exclusion or limitation of incidental or consequential damages, or the exclusion of implied warranties, so the above limitations and exclusions may not be applicable.

WARRANTY SERVICE

For product operation and information assistance, please contact your Dealer or our Customer Care Centre at:
Telephone #: (905) 624-5505 Fax #: (905) 238-2360 Web: www.panasonic.ca

For product repairs, please contact one of the following:

- Your Dealer who will inform you of an authorized Servicentre nearest you.
- Our Customer Care Centre at (905) 624-5505 or www.panasonic.ca
- A Panasonic Factory Servicentre listed below:

Richmond, British Columbia

Panasonic Canada Inc.
12111 Riverside Way
Richmond, BC V6W 1K8
Tel: (604) 278-4211
Fax: (604) 278-5627

Calgary, Alberta

Panasonic Canada Inc.
6835-8th St. N.E.
Calgary, AB T2E 7H7
Tel: (403) 295-3955
Fax: (403) 274-5493

Mississauga, Ontario

Panasonic Canada Inc.
5770 Ambler Dr.
Mississauga, ON L4W 2T3
Tel: (905) 624-8447
Fax: (905) 238-2418

Lachine, Québec

Panasonic Canada Inc.
3075, rue Louis A. Amos
Lachine, QC H8T 1C4
Tel: (514) 633-8684
Fax: (514) 633-8020

IF YOU SHIP THE PRODUCT TO A SERVICENTRE

Carefully pack and send prepaid, adequately insured and preferably in the original carton.
Include details of the defect claimed, and proof of date of original purchase.

WHAT TO DO WHEN SERVICE IS NEEDED

If your Panasonic Vacuum Cleaner needs service, look in the yellow pages of the telephone book under HOME APPLIANCE SERVICE for your nearest Panasonic Services Company ("PASC") Factory Servicenter, or PASC authorized Servicenter, or call, 1-800-211-PANA (7262) toll free to find a convenient servicenter. **DO NOT send the product to the Executive or Regional Sales offices. They are NOT equipped to make repairs.**

If you ship the product

Carefully pack and send it prepaid, adequately insured and preferably in the original carton. Attach a postage-paid letter to the outside of the carton, which contains a description of your complaint. **DO NOT send the product to the Executive or Regional Sales Offices. They are NOT equipped to make repairs.**

PANASONIC CONSUMER ELECTRONICS COMPANY
DIVISION OF MATSUSHITA ELECTRIC CORPORATION OF AMERICA

One Panasonic Way
Secaucus, New Jersey 07094
World Wide Web Address
<http://www.panasonic.com>

What To Do When Service is Needed Service après-vente (Canada)

WARRANTY SERVICE

For product operation and information assistance, please contact your Dealer or our Customer Care Centre at:

Telephone #: (905) 624-5505

Fax #: (905) 238-2360

Web: www.panasonic.ca

For product repairs, please contact one of the following:

- Your Dealer who will inform you of an authorized Servicenter nearest you.
- Our Customer Care Centre at (905) 624-5505 or www.panasonic.ca
- A Panasonic Factory Servicenter

RÉPARATION SOUS GARANTIE

Pour de l'aide sur le fonctionnement de l'appareil ou pour toute demande d'information, veuillez contacter votre détaillant ou notre service à la clientèle au :

N° de téléphone : (905) 624-5505

N° de télécopieur : (905) 238-2360

Site Internet : www.panasonic.ca

Pour la réparation des appareils, veuillez consulter :

- votre détaillant, lequel pourra vous renseigner sur le centre de service agréé le plus près de votre domicile ;
- notre service à la clientèle au (905) 624-5505 ou www.panasonic.ca
- un de nos centres de service.

Cuando necesita servicio

Si su aspiradora Panasonic necesita servicio, busque el Centro de Servicio Panasonic o un Centro de Servicio PASC autorizado más cercano bajo "Servicio de Electrodomésticos" en las páginas amarillas de la guía de teléfonos o llame gratis al 1-800-211-PANA (7262) para encontrar un centro de servicio conveniente. No mande el producto a las Executive o Regional Sales Offices. No están equipadas para arreglar estos productos.

Si manda el producto

Empaquete con cuidado en el cartón original si posible y mándelo prepagado y con seguro suficiente. Ponga una carta con sellos en la que describe su problema con el producto en el exterior del cartón. No mande el producto a las Executive o Regional Sales Offices. No están equipadas para arreglar estos productos.

PANAMEX COMPANY
DIVISION OF MATSUSHITA ELECTRIC CORPORATION OF AMERICA

One Panasonic Way
Secaucus, New Jersey 07094
World Wide Web Address
<http://www.panasonic.com>

AC01ZBZEZ000
C01ZBZE00000

Printed in Mexico
Impreso en Mexico
Imprimé au Mexique