

This Owner's Manual is provided and hosted by [Appliance Factory Parts](#).



# PANASONIC MC-V7375 Owner's Manual

[Shop genuine replacement parts for PANASONIC  
MC-V7375](#)



[Find Your PANASONIC Vacuum Cleaner Parts - Select From 605 Models](#)

----- Manual continues below -----

# Operating Instructions

**QUICKDRAW**  
TOOLS-ON-BOARD WITH READY-TO-USE HOSE

VACUUM CLEANER  
**MC-V7375**

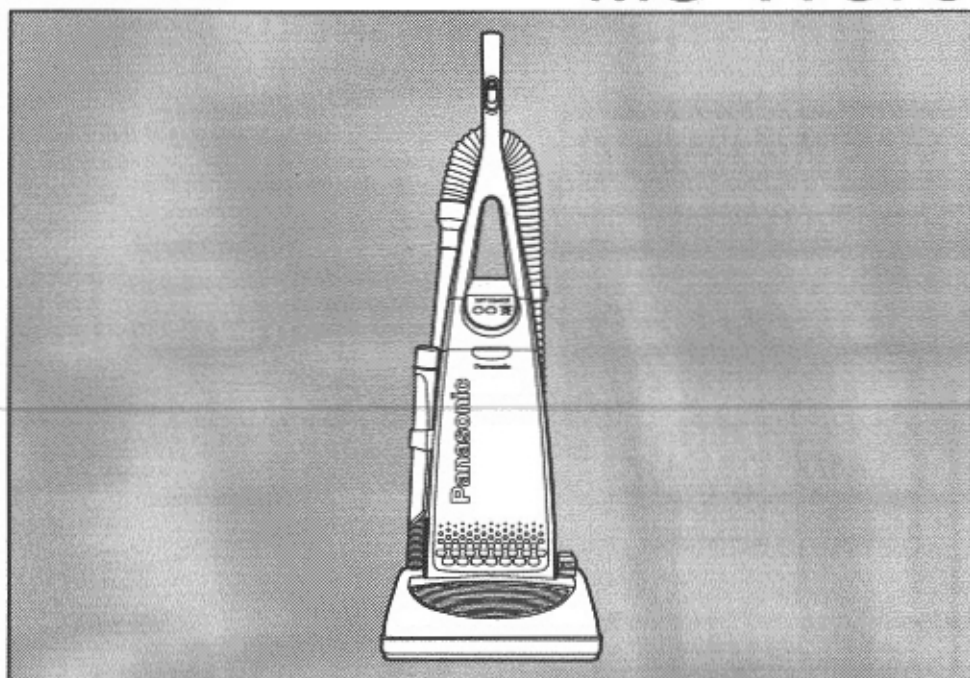

**Panasonic®**

Before operating your vacuum cleaner, please read these instructions completely.

# CONSUMER INFORMATION

Please read **IMPORTANT SAFETY INSTRUCTIONS** on page 4 before use. Read and understand all instructions.

## TO OUR VALUED CUSTOMER

We are very pleased to welcome you to the Panasonic family of products. Thank you for purchasing this product. Our intent is that you become one of our many satisfied customers.

**Proper assembly and safe use of your vacuum cleaner are your responsibilities. Your cleaner is intended only for household use. The cleaner should be stored in a dry, indoor area. Read the Operating Instructions carefully for important use and safety information.**

**Special care is required when vacuuming certain types of carpet or floor covering. Always check the carpet or floor covering manufacturer's recommended cleaning instructions before vacuuming.**

**PLEASE PAY CLOSE ATTENTION TO THE WARNING AND CAUTION STATEMENTS THAT ARE FOUND THROUGHOUT THIS MANUAL.**



**WARNING**

**WARNING** statements are designed to alert you to the possibility of personal injury, loss of human life, and/or damage to the vacuum cleaner and/or personal property if the instructions given are not followed.



**CAUTION**

**CAUTION** statements are designed to alert you to the possibility of damage to the vacuum cleaner and/or personal property if the instructions given are not followed.



**WARNING**

### TO AVOID ELECTRICAL SHOCK

Never vacuum damp or wet surfaces or liquids.  
DO NOT store machine outdoors.  
Replace worn or frayed power cord immediately.

### TO AVOID ACCIDENTS

Except for hand-held cleaners, keep machine on floor - not chairs, tables, steps, stairs, etc.  
Store machine promptly after each use to prevent accidents such as tripping over power cord or machine.  
Use machine and accessories only in a manner intended by the manufacturer.  
The use of an extension cord is not recommended.

©1997 Matsushita Electric Industrial Co., Ltd. All rights reserved.

# TABLE OF CONTENTS

<b>CONSUMER INFORMATION</b> .....	2
<b>IMPORTANT SAFETY INSTRUCTIONS</b> .....	4
<b>PARTS IDENTIFICATION</b> .....	5
Feature Chart .....	5
<b>TO ASSEMBLE CLEANER</b> .....	6
Attaching Handle to Vacuum Cleaner .....	6
Using the Cord Hook .....	6
Attachment Assembly, Tools-on-Board .....	7
<b>SPECIAL FEATURES OF CLEANER</b> .....	8
Automatic Self Adjusting Nozzle .....	8
Edge Cleaning Feature .....	8
Motor Protector .....	8
Carpet/Bare Floor Selector .....	9
Hose Ring and Hose Ring Mount .....	9
Dirt Sensor .....	10
<b>TO OPERATE CLEANER</b> .....	11
Power Cord .....	11
On/Off Switch .....	11
Handle Adjustments .....	11
Dirt Sensor .....	12
Attachments .....	13
<b>ROUTINE CARE OF CLEANER</b> .....	14
Cleaning Secondary Foam Filter .....	14
Replacing HEPA Type Exhaust Filter .....	14
Changing the Dust Bag .....	15
Removing/Installing the Lower Plate .....	16
Replacing the Headlight Bulb .....	16
Replacing the Belt .....	17
Cleaning the Agitator .....	17
Replacing the Agitator .....	18
Cleaning Dirt Sensor Optics .....	19
Cleaning Exterior and Attachments .....	19
Removing Clogs .....	20
<b>BEFORE REQUESTING SERVICE</b> .....	21
<b>NOTES</b> .....	22
<b>WARRANTY</b> .....	23
<b>WHAT TO DO WHEN SERVICE IS NEEDED</b> .....	24

# IMPORTANT SAFETY INSTRUCTIONS

When using vacuum cleaner, basic precautions should always be followed, including the following:

## READ ALL INSTRUCTIONS BEFORE USING THIS VACUUM CLEANER

### WARNING

To reduce the risk of fire, electrical shock, injury:

1. **DO NOT** leave vacuum cleaner when plugged in. Unplug from outlet when not in use and before servicing.
2. To reduce the risk of fire, electric shock - **DO NOT** use outdoors or on wet surfaces.
3. **DO NOT** allow to be used as a toy. Close attention is necessary when used by or near children.
4. Use only as described in this manual. Use only manufacturer's recommended attachments.
5. **DO NOT** use with damaged cord or plug. If vacuum cleaner is not working as it should, has been dropped, damaged, left outdoors, or dropped into water, return it to an authorized Panasonic Servicenter.
6. **DO NOT** pull or carry by cord, use cord as a handle, close door on cord, or pull cord around sharp edges or corners. **DO NOT** run vacuum cleaner over cord. Keep cord away from heated surfaces.
7. **DO NOT** unplug by pulling on cord. To unplug, grasp the plug, not the cord.
8. **DO NOT** handle plug or vacuum cleaner with wet hands.
9. **DO NOT** put any objects into openings. **DO NOT** use with any opening blocked; keep free of dust, lint, hair, and anything that may reduce air flow.
10. Keep hair, loose clothing, fingers, and all parts of body away from openings and moving parts.
11. **DO NOT** pick up anything that is burning or smoking, such as cigarettes, matches, or hot ashes.
12. **DO NOT** use without dust bag and/or filters in place.
13. Turn off all controls before unplugging.
14. Use extra care when cleaning on stairs.
15. **DO NOT** use cleaner to pick up flammable or combustible liquids such as gasoline or use in areas where they may be present.

## SAVE THESE INSTRUCTIONS

### THIS VACUUM CLEANER IS INTENDED FOR HOUSEHOLD USE ONLY

**Note:** Before you plug in your Panasonic vacuum cleaner, make sure that the voltage indicated on the rating plate located at the back of the vacuum cleaner is the same as your local supply.

# PARTS IDENTIFICATION

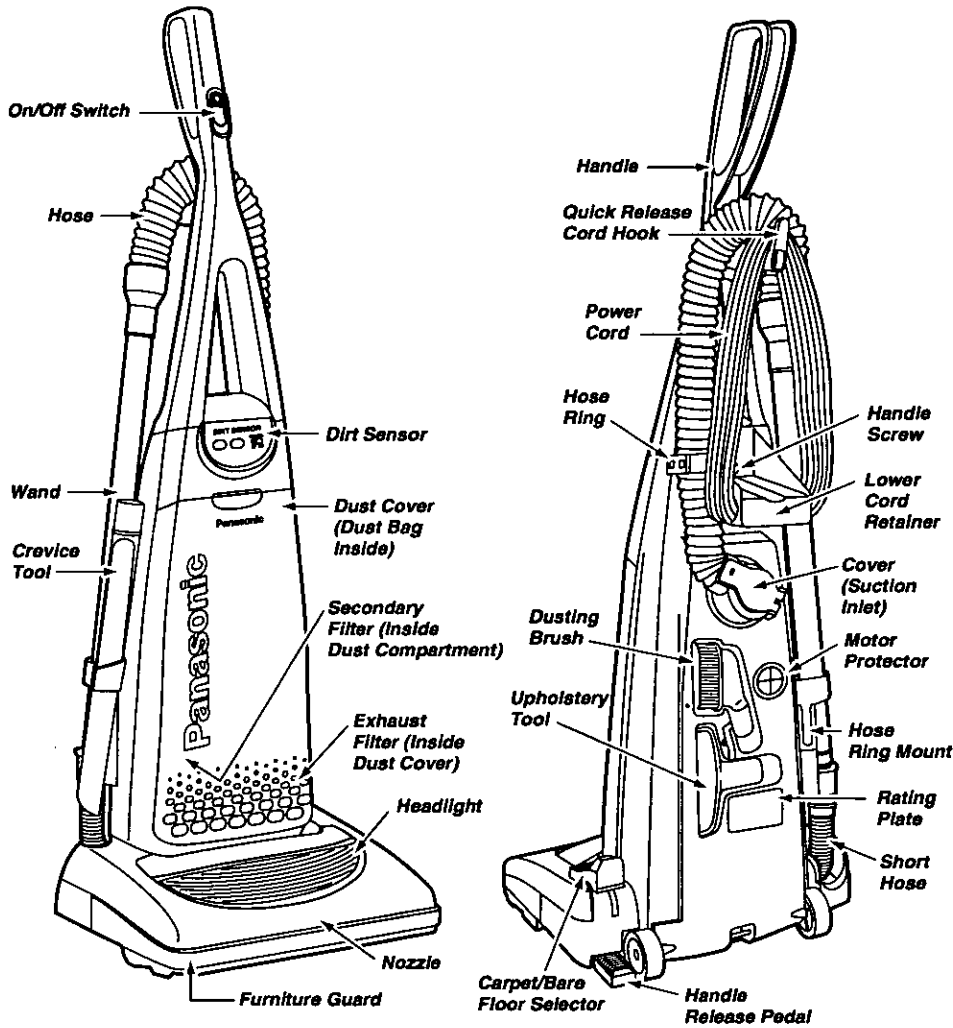

## FEATURE CHART (PANASONIC UPRIGHT VACUUM CLEANER)

FEATURES	POWER	DIRT SENSOR	HEADLIGHT	CORD LENGTH	BARE FLOOR OPTION
Model					
MC-V7375	120V. AC(60Hz) 12.0 Amps	Yes	Yes	30 Ft.	Yes

# TO ASSEMBLE CLEANER



## **WARNING** Electrical Shock Hazard.

**DO NOT** plug into electrical supply until assembly is complete. Failure to do so could result in electrical shock or injury.

### ATTACHING HANDLE TO VACUUM CLEANER

The vacuum cleaner main body and handle are packed separately.

1. The handle screw has been installed for shipping purposes. Please remove the screw before inserting the handle. Insert the handle as shown in the illustration. **Make sure the ON/OFF switch is in the OFF position before installing.**

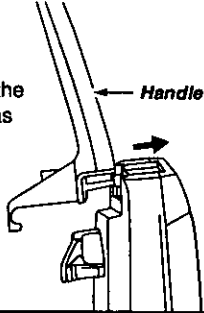

2. Insert the screw that you have removed. Be sure the screw is tightened, but not overtightened.

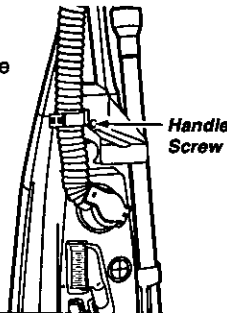

3. There are two (2) recessed areas located on the handle, as shown in the illustration, designed to secure the power cord during vacuuming.

Always push the power cord down into these recessed areas to help keep the power cord from hanging near the nozzle and being damaged by the agitator.

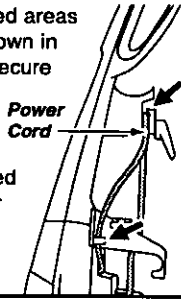

4. Loosely wrap the power cord around the quick release cord hook and the lower cord retainer. Secure the plug head to the cord by pushing the power cord into the retainer on the plug head.

Retainer (Plug Head)

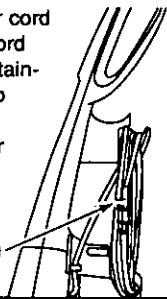

### USING THE CORD HOOK

1. The upper cord hook has a quick-release action. To release the power cord, rotate the hook downward and the complete power cord will drop off the hook for immediate use.

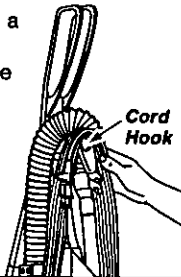

2. **DO NOT** unplug the power cord by pulling on the cord. Grasp the plug head and pull to unplug the vacuum cleaner.

Return the hook to the upright position before attempting to rewind the cord.

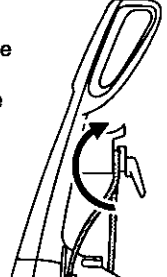

# ATTACHMENT ASSEMBLY, Tools-on-Board



## CAUTION

DO NOT get the power cord caught under the nozzle when using the vacuum or attachments as it can be damaged by the agitator as it revolves.

## ATTACHMENTS

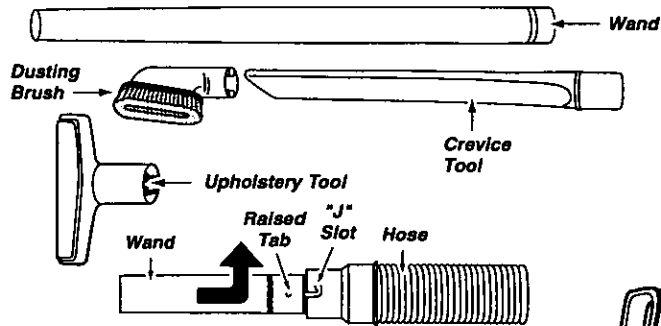

The attachments should be conveniently positioned on the back and side of the cleaner for easy access. Some of the attachments may already be assembled. Assemble the hose and attachments to the cleaner as follows:

Place the hose in back of the handle on the hose holder. Attach the wand to the hose by aligning the two (2) raised tabs on the wand with the "J" slots in the hose. After guiding the tabs along the grooves, twist to lock in place.

Place the wand in the rear slot of the tool holder, twisting and pushing down over the short hose to assure a good connection.

Store the dusting brush, and the upholstery tool in the rear of the dust compartment in their proper locations. Place the crevice tool into the front slot of the tool holder. Refer to the illustration in the PARTS IDENTIFICATION section for correct attachment storage.

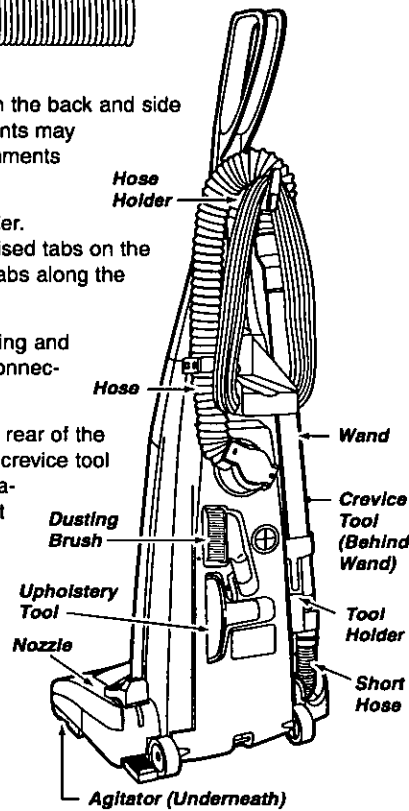

# SPECIAL FEATURES OF CLEANER

## AUTOMATIC SELF ADJUSTING NOZZLE

Your Panasonic upright vacuum cleaner is designed with an automatic self adjusting nozzle. No manual adjustments are required. The height of the nozzle is instantly and automatically adjusted to any carpet pile height. This self adjusting feature allows the nozzle to float evenly over all carpet pile surfaces.

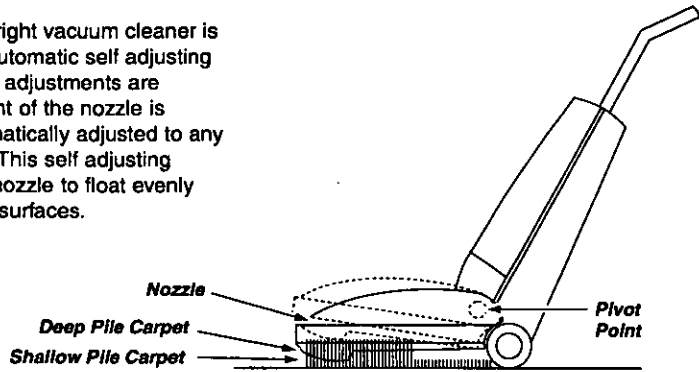

## EDGE CLEANING FEATURE

The edge cleaning feature provides for improved cleaning of carpets near walls and furniture.

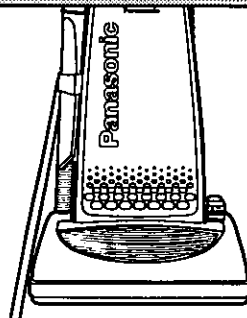

## MOTOR PROTECTOR

This vacuum has a motor protector by-pass valve which automatically opens to provide cooling air to the motor when a clog prevents the normal flow of air to the motor. The by-pass valve opens to prevent the motor from overheating and possibly causing damage to the vacuum. When open, a change of sound will be noticed as air rushes through the valve opening. If this occurs, turn the vacuum off and unplug the power cord from the outlet. Check for clogs as described in the REMOVING CLOGS section.

The motor protector by-pass valve may open when using attachments or when cleaning new carpet, due to reduced air flow by the attachments themselves or by new carpet fuzz filling the bag quickly.

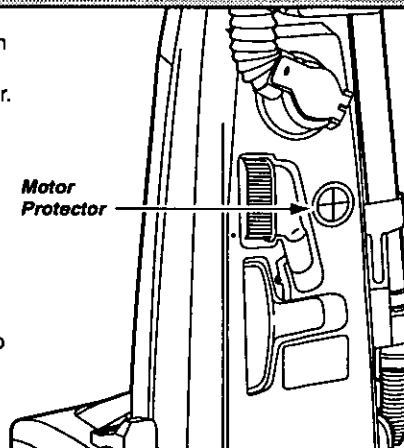

## CARPET/BARE FLOOR SELECTOR

To use cleaner on bare floors, the carpet/bare floor selector on top of the nozzle should be positioned all the way back and down toward the bottom of the nozzle until it locks into place. When the selector is in this position the agitator does not turn. This is also the correct position to place the selector in to use the attachments. Any time the attachments are used the agitator should not be turning.

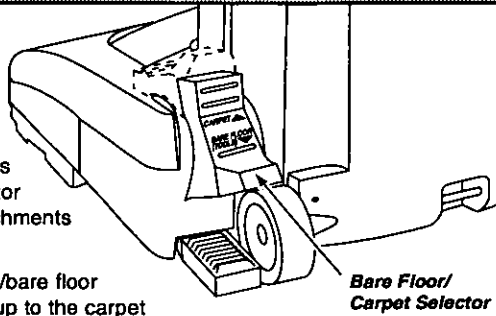

To use cleaner on carpeted areas, the carpet/bare floor selector should be **all the way forward** and up to the carpet position. This will allow the agitator to turn. When carpets are being cleaned the selector should remain in this position.

Take care when selecting either position to make sure the selector is pushed **fully and quickly** as possible to the desired position. Failure to do so can cause the belt to rub on the selector shaft and may result in the belt becoming hot and creating a burning rubber smell.

To prevent injury when returning the selector to the carpet position, use caution as the selector can move quickly upward due to tension caused by the belt.

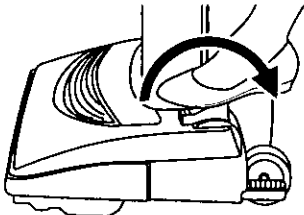

To clean bare floor  
or use attachments

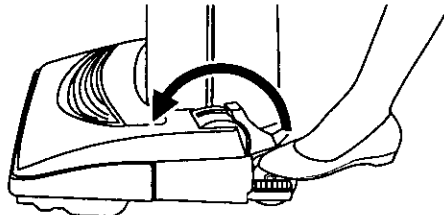

To clean carpet

## HOSE RING AND HOSE RING MOUNT

The hose ring is a feature designed to prevent tipping of the vacuum while performing certain tasks that involve the use of the attachments. To use this anti-tip feature, place the hose ring in the hose ring mount as shown in the illustration. Rotate this ring on the hose so that the hose ring knob will align with the slot in the hose ring mount and slide the ring down firmly until it stops. For recommendations on when to use the hose ring and the exact location of the hose ring mount see the ATTACHMENTS section.

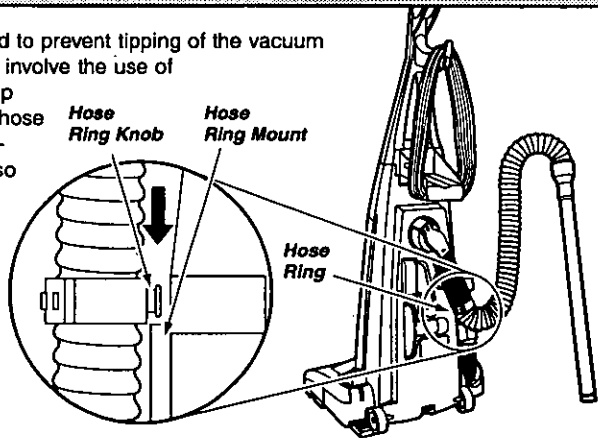

## DIRT SENSOR

The electronic sensor is a feature which will detect particles as they pass through the vacuum cleaner.

A red light indicates dirt is being picked up by the cleaner. A green light indicates most of the dirt has been picked up by the cleaner.

The dirt sensor indicators and sensor sensitivity switch are located on the front of the switch cover. See the DIRT SENSOR section under TO OPERATE CLEANER section for operation.

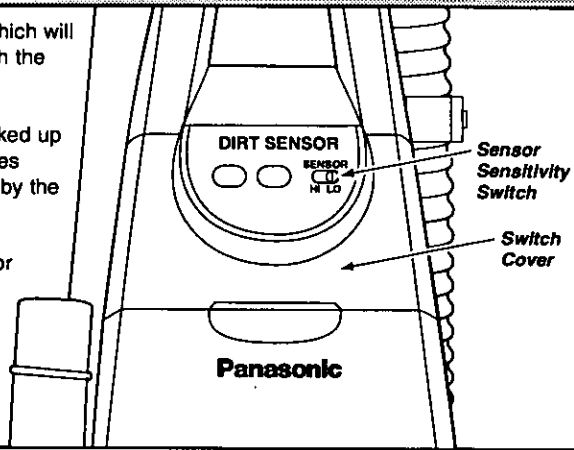

# TO OPERATE CLEANER



## CAUTION

**DO NOT use outlets above counters. Damage to items in the surrounding areas could occur. Be sure the switch is in the off position while plugging the cord in.**

## POWER CORD

**NOTE:** To reduce the risk of electrical shock, this vacuum has a polarized plug, one blade is wider than the other. This plug will fit in a polarized outlet only one way. If the plug does not fit fully in the outlet, reverse the plug. If it still does not fit, contact a qualified electrician to install the proper outlet. **DO NOT CHANGE THE PLUG IN ANY WAY.**

## ON/OFF SWITCH

1. Plug the power cord into a 120V outlet.
2. To start the vacuum cleaner, push the switch to the ON position.
3. To stop the vacuum cleaner, push the switch to the OFF position.

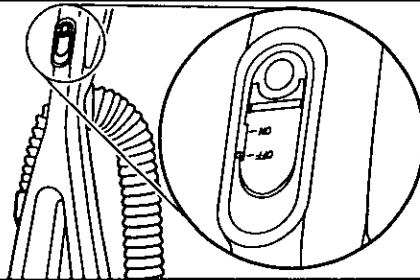

## HANDLE ADJUSTMENTS

The handle may be lowered to any position required. Just step on the handle release pedal as indicated by the illustration and lower the handle as desired.

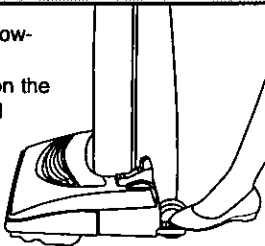

### 1. Upright position

The handle locks in this position for storage. The handle should always be in an upright position when the attachments are used.

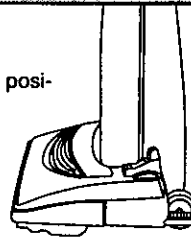

### 2. Middle position

This position is for normal cleaning.

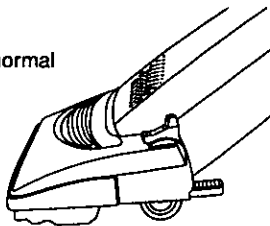

### 3. Low position

This position is used for cleaning under furniture.

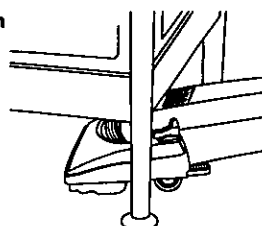

## DIRT SENSOR

**OPERATION** - As you vacuum, the red indicator light will come on and stay on as long as the sensor detects a high concentration of particles passing through the cleaner.

The green light indicates that most of the cleaning is complete.

The sensor switch allows you to select the sensitivity of the dirt sensor. The switch can be set to HI or LO sensitivity.

Set the sensor switch to the HI position when:

- Cleaning bare floors.
- Cleaning carpet with low pile height.

Set the sensor switch to the LO position when:

- Cleaning heavily soiled areas.
- Cleaning carpet with deep pile.
- Cleaning new carpets.

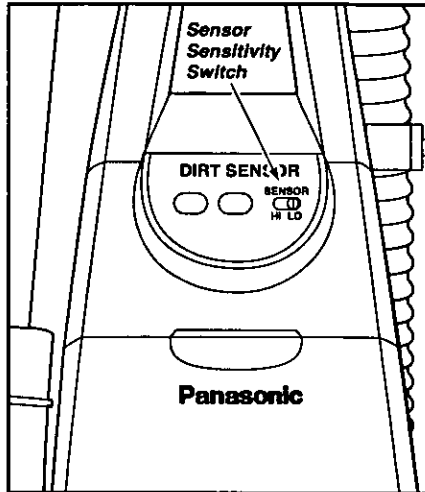

Even with the sensor switch in the LO position, the dirt sensor will detect carpet fuzz, especially on new carpet, which may cause the red light to remain on longer than expected.



# WARNING

Personal Injury Hazard when Using Attachments.

**DO NOT** place hands or feet underneath the unit when using the attachment tools. The agitator begins to revolve rapidly when using attachments.

## ATTACHMENTS



# CAUTION

When using the attachments, the agitator begins rotating if the carpet/bare floor selector is not in the bare floor position. Always use the bare floor position when using attachments. **DO NOT** allow the cleaner to remain in just one place for a period of time, as the agitator may damage the floor surface. Avoid placing the cleaner on furniture, the fringed area of rugs, deep pile carpeting, or carpeted stairs. The ideal position for the cleaner when using attachments is for the unit to be on a level area with the handle in the full upright position. See the HANDLE ADJUSTMENTS section.



When using the attachments always place the carpet/bare floor selector in the bare floor position. To remove the wand from the short hose, grasp the top part of the wand, see illustration, and twist as you pull up. Once the wand has been removed it can be used as is, or the tools can be used. The tools can be attached to the hose or the end of the wand. When connecting the attachments, always twist as you push down. If additional reach is required, the dusting brush or upholstery tool can be attached to the end of the crevice tool by simply sliding it over the narrow end of the crevice tool. The attached hose end swivels at the back of the cleaner to make cleaning easier in all directions.

When using the attachments, **DO NOT** overextend your reach with the hose as it could tip the cleaner over. To help prevent tipping of the vacuum when using the attachments to clean areas below the upper cord hook, the hose ring should be placed in the hose ring mount. Above this level, unhook the hose ring from the hose ring mount.

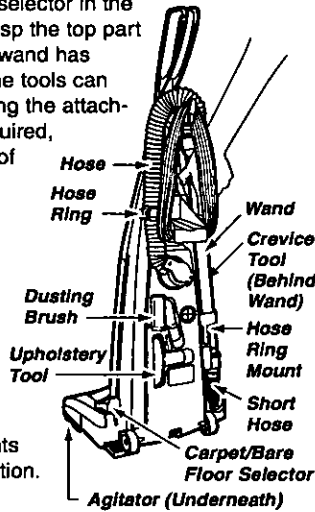
When attaching the wand to the hose and storing the attachments follow the directions given in the ATTACHMENT ASSEMBLY section.



### ATTACHMENT USE

ATTACHMENT	CLEANING AREA				
	Furniture*	Between Cushions*	Drapes*	Stairs	Walls
CREVICE TOOL 	X	X	X	X	X
DUSTING BRUSH 	X		X	X	X
UPHOLSTERY TOOL 	X	X	X		

\*Always clean attachments before using on fabrics. Attachments used in dirty areas, such as under a refrigerator, should not be used on other surfaces until they are washed. They could leave marks. See the CLEANING EXTERIOR AND ATTACHMENTS section.

# ROUTINE CARE OF CLEANER

Performing the following tasks will keep your new Panasonic vacuum cleaner operating at peak performance levels and will ensure these high levels for years to come. Check the BEFORE REQUESTING SERVICE section in this manual for recommendations on performing some of these tasks to help solve various problems that may occur.



## WARNING

*Electrical Shock or Personal Injury Hazard.*

*Always disconnect electrical supply before performing any service and/or cleaning of the vacuum cleaner. Failure to do so could result in electrical shock or personal injury from cleaner suddenly starting. DO NOT operate the cleaner without the secondary filter. Be sure the secondary filter is properly installed. Failure to do so could result in motor failure.*

## CLEANING SECONDARY FOAM FILTER

A secondary foam filter protects the motor from dirt. When installing a new dust bag, check this filter. Accumulated dirt in the dust compartment will collect on this filter and may restrict motor performance. When this filter becomes dirty, pull it from the bottom of the dust compartment and clean by rinsing it in water. When dry, slide this filter back into place. Insert the secondary foam filter with a ruler or something flat. It should be fully inserted under the plastic rib projections all the way to the rear.

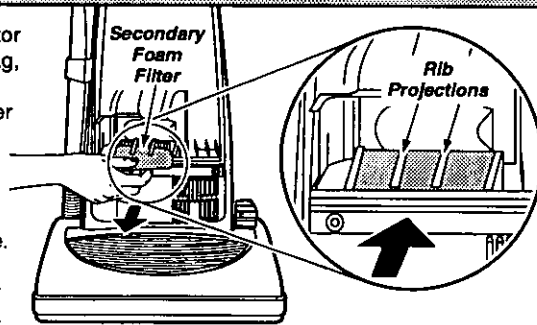

## REPLACING HEPA TYPE EXHAUST FILTER

The HEPA type exhaust filter is located inside the dust cover. The purpose of this filter is to remove dust and dirt from the recirculated air. When installing a new dust bag, check this filter. When the filter becomes dirty, remove the filter and the frame from the bottom of the dust cover by pulling straight up on the two retainers on the frame. Do one side at a time. Replace the filter. **DO NOT CLEAN WITH WATER\***. Place the new filter in the frame with the four slots in the filter aligned with the four tabs on the frame. Place the frame and the filter back into the dust cover, making sure the white side is facing up.

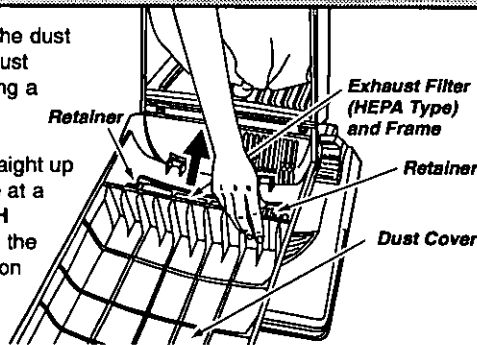

**\*This filter cannot be cleaned and should be replaced at least once each year if the cleaner is used at least one hour each week.**

## CHANGING THE DUST BAG

Always operate the vacuum with a genuine Panasonic Type U3 Standard or U6 Electrostatic dust bag installed. Panasonic dust bags may be ordered through any authorized Panasonic dealer.

1. Pull outward on the dust cover grip, located on the top of the dust cover and remove the cover.

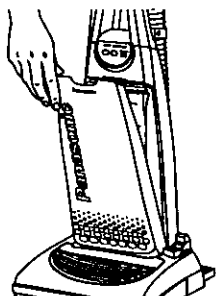

2. To remove the dust bag, grasp the cardboard portion of the dust bag and pull it out.

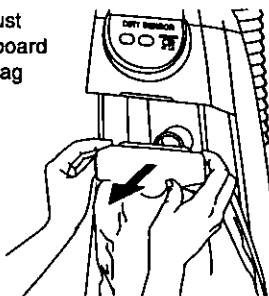

3. Spread out the end of the new dust bag.

**NOTE:** Pull carefully so as not to tear the bag at the folds.

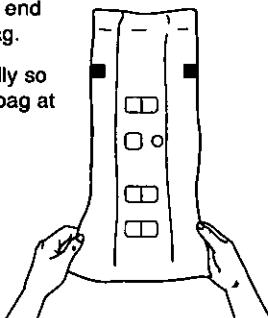

4. Fold the new dust bag to clear the slots as shown in illustration. Failure to do so will prevent the dust cover from closing properly. Attach the new dust bag onto the bag holder by holding the cardboard portion and pushing back as illustrated.

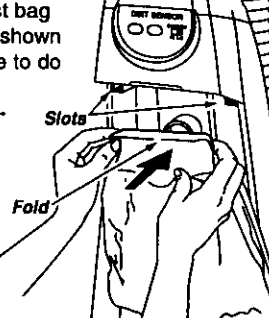

5. Reinsert the tab provided on the end of the dust cover into the grooves on the dust compartment to allow the cover to rotate closed.

**NOTE:** The dust cover must be completely and correctly installed for proper operation.

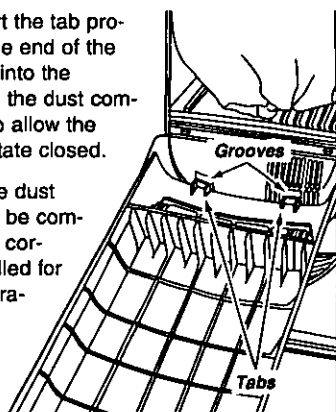

6. Rotate the dust cover up into the closed position and press into place.

**NOTE:** The dust bag should not be caught between the lower edge of the dust cover and the gasket as indicated by the arrow in the illustration.

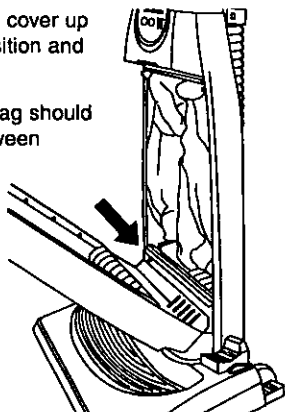



## **WARNING** Electrical Shock or Personal Injury Hazard.

When the lower plate is removed for any reason, before reinstalling, be sure that all electrical wires are routed in a manner that prevents them from coming into contact with the lower plate, lower plate screws, or any moving parts. Be sure that the wires are not pinched in any way when the lower plate is reinstalled.

### REMOVING/INSTALLING THE LOWER PLATE

Before replacing any parts, disconnect the vacuum cleaner from the electrical outlet.

Replacing some of the parts in this section involves the removal and installation of the lower plate. Always place paper under nozzle anytime the lower plate is removed to protect the floor surface.

#### **To Remove Lower Plate.**

Start by placing the handle in the upright position. See the HANDLE ADJUSTMENTS section. Turn the vacuum cleaner over, exposing the underside. Release the lower plate by removing the two (2) screws and pressing inward on the two (2) locking tabs that secure the lower plate, as shown in the illustration. Remove the lower plate and remove any residue that may exist in the belt area.

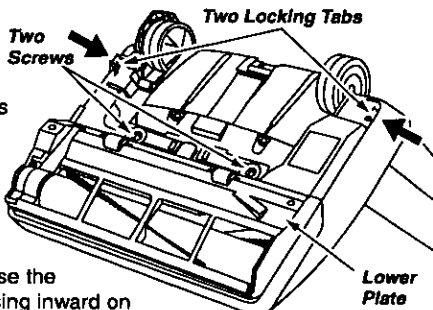

#### **To Reinstall Lower Plate.**

Hook the front end of lower plate into the slots on the front of the nozzle housing. Press the lower plate into place until the locking tabs snap into place then replace the two (2) screws.

**NOTE:** To ensure maximum cleaning efficiency, the belt should be checked regularly to make sure it is in good condition. Check to see if the belt is stretched, cracked, or if excessive slippage has occurred. Replace if necessary.

### REPLACING THE HEADLIGHT BULB

1. Remove the lower plate using the procedure in the REMOVING/INSTALLING THE LOWER PLATE section.

2. Grasp the bulb socket, wiggle the socket back and forth while pulling it up out of the nozzle housing. To remove the old bulb, push it in toward the bulb socket while turning counterclockwise, then remove.

3. Install the new bulb by pushing it in toward the bulb socket and turning it clockwise. Use any standard bayonet base appliance bulb rated at 15 Watts.

**NOTE:** Do not use a bulb rated over 15 Watts. During extended use, heat from the bulb could overheat the surrounding plastic parts.

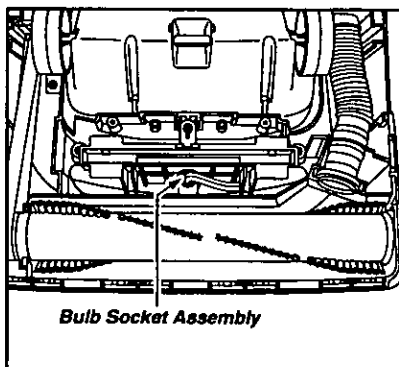

*Bulb Socket Assembly*

4. Reinsert the bulb socket into the nozzle housing by pushing it back down into the slot. Replace the lower plate as outlined in the REMOVING/INSTALLING THE LOWER PLATE section.

## REPLACING THE BELT



### **WARNING** Personal Injury Hazard.

Be careful when removing agitator. The belt tension is high. Failure to do so could result in personal injury from agitator releasing quickly and snapping away.

Place the carpet/bare floor selector in the carpet position. Unplug and turn the unit over. Remove the lower plate as described in the REMOVING/ INSTALLING THE LOWER PLATE section.

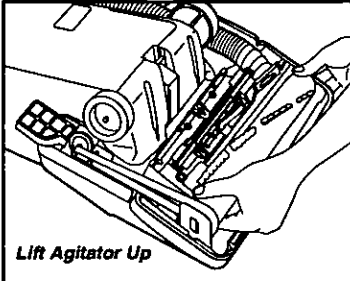

Lift Agitator Up

Remove the agitator, carefully lift it out, and remove the worn or broken belt from the brush pulley and motor shaft. **NOTE:** The two brush supports may come off along with the two washers as you lift the agitator out. **DO NOT** lose the two small washers.

Loop the new belt around the motor shaft and loop it around the brush pulley. See illustration for correct belt routing. **Use only a Panasonic Type UB8 drive belt.**

Before reinserting the agitator make sure the brush supports/washers are on correctly. See illustration in the REPLACING THE AGITATOR section.

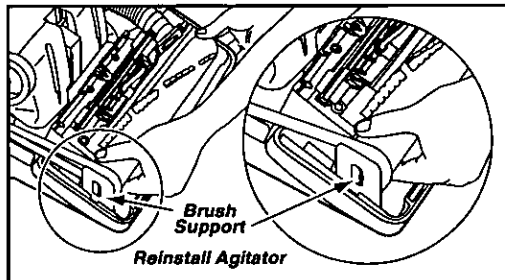
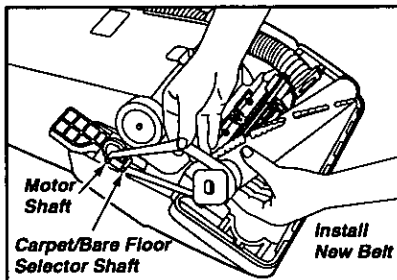

After checking the brush supports, reinstall the agitator back into the housing grooves. After installing the agitator, turn it by hand making sure that the belt is not twisted or pinched and all rotating parts turn freely. Replace the lower plate as described in the REMOVING/INSTALLING THE LOWER PLATE section.

## CLEANING THE AGITATOR

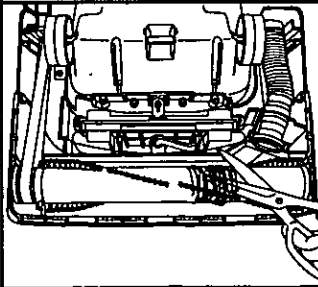

Switch off the vacuum cleaner and unplug the power cord before cleaning the agitator. In order to keep the cleaning efficiency high, clean the agitator regularly. Remove the lower plate if necessary. See the REMOVING/INSTALLING THE LOWER PLATE section for the proper procedure.

Agitator - Cut off any carpet pile and lint entangled around the agitator with a pair of scissors as illustrated.

## REPLACING THE AGITATOR

### 1. When to replace the agitator.

The agitator should be replaced when the brushes are worn. Brushes should be checked by holding a card across the lower plate, see illustration. If the bristles on the agitator **DO NOT** touch the card, you **SHOULD** replace the agitator for best cleaning results.

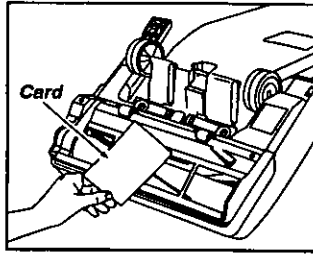

### 2. How to replace the agitator.

Place the vacuum cleaner handle in the upright position. See the HANDLE ADJUSTMENTS section. Remove the lower plate as outlined in the REMOVING/INSTALLING THE LOWER PLATE section. After the lower plate is removed, carefully lift up the agitator until it clears both sides of the nozzle housing. While holding the agitator up, remove the belt.

**NOTE:** The two brush supports may come off along with the two washers as you lift the agitator out. **DO NOT** lose the two small washers. Look at the exploded view of the agitator below for correct assembly of the parts.

### 3. To replace the agitator.

Place the belt over the belt pulley on the brush unit. **NOTE:** There is a place for the belt to fit on one end of the agitator only. Replace both washers and brush supports, see illustration below for correct assembly. After assembling the belt, washers and brush supports place the agitator back into the nozzle housing by aligning each brush support.

After completing the assembly, rotate the brush, turning it by hand to assure that it rotates smoothly and the part is assembled correctly.

Replace the lower plate as outlined in the REMOVING/INSTALLING THE LOWER PLATE section.

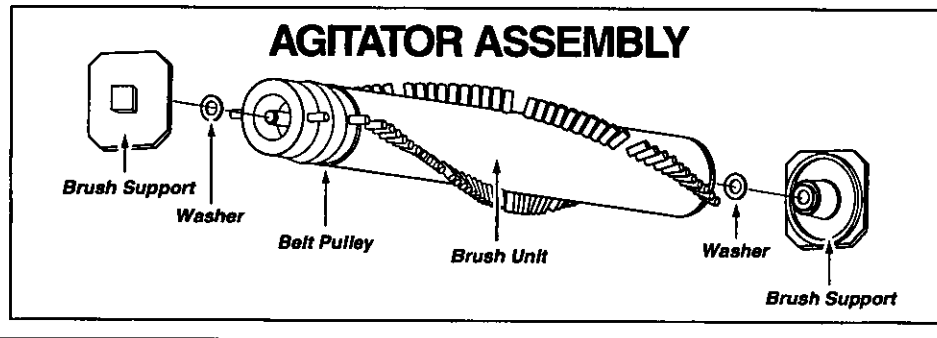

## CLEANING DIRT SENSOR OPTICS

The dirt sensor optics consist of two optic cells located inside the bag holder. Occasionally, it may become necessary to clean the two optic cells to assure maximum performance. It is recommended the optic cells be cleaned:

- When the red light does not light.
- When dirt or dust adheres to the optic cells.
- Whenever the dust bag is changed.

To clean the sensor, wipe the optic cells with a soft, dry cloth. Never use cleaners or liquids as they can help speed the recoating of the optic cells and make it necessary to clean them much sooner than normal. The dirt sensor area can be reached by removing the dust cover and the dust bag.

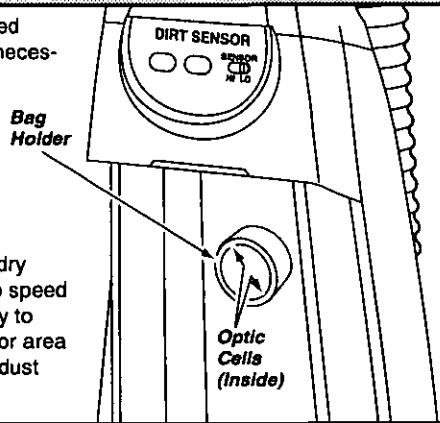

## CLEANING EXTERIOR AND ATTACHMENTS

1. Unplug cord from wall outlet. **DO NOT** drip water on cleaner.
2. Clean exterior using a clean, soft cloth that has been dipped in a solution of mild liquid detergent and water and wrung dry. Wipe dry after cleaning.
3. To reduce static electricity and dust build-up, wipe outer surface of cleaner and attachments.
4. Wash attachments in warm soapy water, rinse and air dry. **DO NOT** clean in dishwasher or clothes washer.

**DO NOT USE ATTACHMENTS IF THEY ARE WET.**



### **CAUTION**

*Attachments used in dirty areas, such as under a refrigerator, should not be used on other surfaces until they are washed. They could leave marks.*

## REMOVING CLOGS

The hose located on the back of the vacuum cleaner carries the dirt from the nozzle up to the dust bag. If the hose should become clogged:

1. Unplug the power cord from the outlet before checking the airflow passages. Pull open the suction inlet cover and check for clogging in this area.

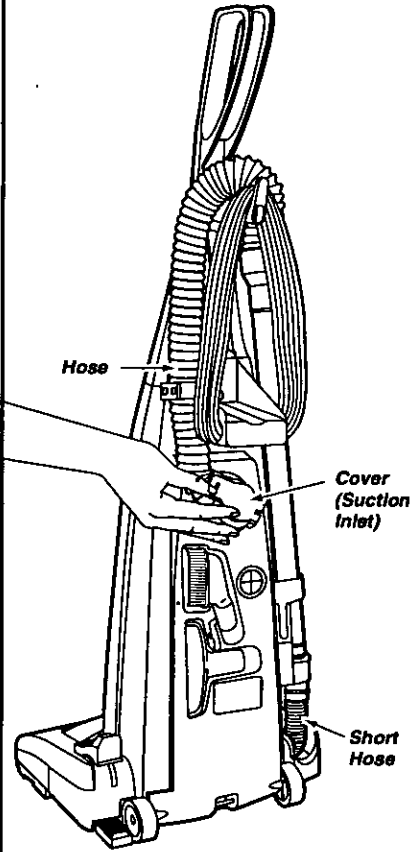

2. Disconnect the wand from the short hose and check the wand and hose for clogging. Plug in the vacuum cleaner and turn it on. While running the vacuum cleaner with the wand disconnected, stretch the hose in and out to remove the clog.

3. If the clog still exists, turn the vacuum cleaner OFF and unplug the power cord. Turn the vacuum cleaner over, exposing the underside. Remove the lower plate. Remove the short hose from the housing by lifting it straight up. Inspect the hose end and clear it of any obstructions. Reinstall the short hose and lower plate. See the REMOVING/INSTALLING THE LOWER PLATE section for detailed instructions.

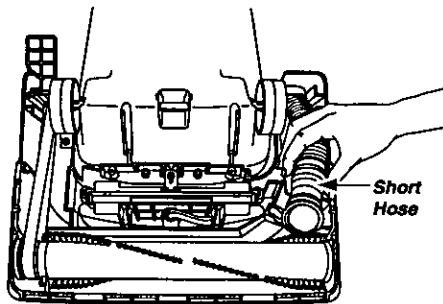

# BEFORE REQUESTING SERVICE



## **WARNING** *Electrical Shock or Personal Injury Hazard.*

*Disconnect the electrical supply before servicing or cleaning the unit. Failure to do so could result in electrical shock or personal injury from cleaner suddenly starting.*

Review this chart to find do-it-yourself solutions for minor performance problems. Any service needed, other than those described in these Operating Instructions, should be performed by an authorized service representative.

<b>PROBLEM</b>	<b>POSSIBLE CAUSE</b>	<b>POSSIBLE SOLUTION</b>
<b>Cleaner will not run.</b>	<ol style="list-style-type: none"> <li>1. Unplugged at wall outlet.</li> <li>2. On/Off switch not turned on.</li> <li>3. Tripped circuit breaker/blown fuse at household service panel.</li> </ol>	<ol style="list-style-type: none"> <li>1. Plug in firmly. Push On/Off switch to On.</li> <li>2. Push On/Off switch to On.</li> <li>3. Reset circuit breaker or replace fuse.</li> </ol>
<b>Poor job of dirt pickup.</b>	<ol style="list-style-type: none"> <li>1. Full or clogged dust bag.</li> <li>2. Broken belt.</li> <li>3. Carpet/bare floor setting incorrect.</li> <li>4. Clogged hose or nozzle.</li> <li>5. Hose not inserted fully.</li> <li>6. Worn agitator.</li> <li>7. Hole in hose.</li> <li>8. Dust cover improperly installed.</li> <li>9. Belt not installed on motor shaft.</li> </ol>	<ol style="list-style-type: none"> <li>1. Change bag.</li> <li>2. Replace belt.</li> <li>3. Set in the correct position.</li> <li>4. Clean hose or nozzle area.</li> <li>5. Insert hose.</li> <li>6. Replace agitator.</li> <li>7. Replace hose.</li> <li>8. Properly install dust cover.</li> <li>9. Install belt on motor shaft.</li> </ol>
<b>Bare floor option will not work.</b>	<ol style="list-style-type: none"> <li>1. Belt improperly installed with bare floor selector in wrong position.</li> </ol>	<ol style="list-style-type: none"> <li>1. Properly install belt.</li> </ol>
<b>Dust escapes the paper bag.</b>	<ol style="list-style-type: none"> <li>1. Bag improperly installed.</li> <li>2. Bag torn.</li> </ol>	<ol style="list-style-type: none"> <li>1. Properly install bag.</li> <li>2. Replace bag.</li> </ol>
<b>Light will not work.</b>	<ol style="list-style-type: none"> <li>1. Burned out light bulb.</li> </ol>	<ol style="list-style-type: none"> <li>1. Replace light bulb.</li> </ol>
<b>Dirt sensor will not work.</b>	<ol style="list-style-type: none"> <li>1. Dirty optic cells.</li> </ol>	<ol style="list-style-type: none"> <li>1. Clean optic cells.</li> </ol>

# WARRANTY

## Panasonic Vacuum Cleaner Limited Warranty

Panasonic Consumer Electronics Company or Panasonic Sales Company (collectively referred to as "the warrantor") will repair this product with new or refurbished parts free of charge, in the U.S.A. or Puerto Rico for one (1) year from the date of original purchase in the event of a defect in materials or workmanship.

**This Limited Warranty Excludes both Labor and Parts for the following items which require normal replacement:** Disposable Dust Bag, Filters, Belts, Light Bulbs, Agitator Brushes and Batteries (if supplied).

Carry-in or mail-in service in the U.S.A. or Puerto Rico can be obtained during the warranty period by contacting a Panasonic Services Company (PASC) Factory Servicenter listed in the Servicenter Directory. Or call, toll free, 1-800-545-2672 to locate a PASC Authorized Servicenter. Carry-in or mail-in service in Puerto Rico can be obtained during the warranty period by calling the local Panasonic Sales Company telephone number listed in the Servicenter Directory.

This warranty is extended only to the original purchaser. A purchase receipt or other proof of date of original purchase will be required before warranty performance is rendered.

This warranty only covers failures due to defects in materials and workmanship which occur during normal use and does not cover damages which occur in shipment, or failures which are caused by products not supplied by the warrantor, or failures which result from accident, misuse, abuse, neglect, mishandling, misapplication, faulty installation, improper operation or maintenance, alteration, modification, power line surge, improper voltage supply, lightning damage, commercial use such as hotel, office, restaurant or other business or rental use of the product, or service by anyone other than a PASC Authorized Servicenter, or damage that is attributable to acts of God.

### **LIMITS AND EXCLUSIONS:**

There are no express warranties except as listed above.

THE WARRANTOR SHALL NOT BE LIABLE FOR INCIDENTAL OR CONSEQUENTIAL DAMAGES RESULTING FROM THE USE OF THIS PRODUCT, OR ARISING OUT OF ANY BREACH OF THIS WARRANTY. ALL EXPRESS AND IMPLIED WARRANTIES, INCLUDING THE WARRANTIES OF MERCHANTABILITY AND FITNESS FOR A PARTICULAR PURPOSE, ARE LIMITED TO THE APPLICABLE WARRANTY PERIOD SET FORTH ABOVE.

Some states do not allow the exclusion or limitation of incidental or consequential damages, or limitations on how long an implied warranty lasts, so the above exclusions or limitations may not apply to you.

This warranty gives you specific legal rights and you may also have other rights which vary from state to state. If a problem with this product develops during or after the warranty period, you may contact your dealer or Servicenter. If the problem is not handled to your satisfaction, then write to the Customer Satisfaction Center at the listed address on the back cover.

# WHAT TO DO WHEN SERVICE IS NEEDED

If your Panasonic Vacuum Cleaner needs service, look in the yellow pages of the telephone book under HOME APPLIANCE SERVICE for your nearest Panasonic Services Company ("PASC") Factory Servicenter, or PASC authorized Servicenter, or call 1-800-545-2672, toll free to find a convenient servicenter. **DO NOT** send the product to the Executive or Regional Sales offices. They are **NOT** equipped to make repairs.

## If you ship the product

Carefully pack and send it prepaid, adequately insured and preferably in the original carton. Attach a postage-paid letter to the outside of the carton, which contains a description of your complaint. **DO NOT send the product to the Executive or Regional Sales Offices. They are NOT equipped to make repairs.**

## Customer's Record

Model No. \_\_\_\_\_ Dealer's Name \_\_\_\_\_

Serial No. \_\_\_\_\_

Dealer's Address \_\_\_\_\_

Date of Purchase \_\_\_\_\_

Consumers requiring product information or operating assistance with a consumer product should contact:

### CUSTOMER SATISFACTION CENTER DEPARTMENT 2F-3

50 Meadowlands Parkway  
Secaucus, N.J. 07094  
(201) 348-9090

**DIAL TOLL FREE  
1-800-545-2672**

**Panasonic Services Co.**

**24 hours a day,  
7 days a week**

PANASONIC CONSUMER ELECTRONICS  
COMPANY, DIVISION OF MATSUSHITA ELECTRIC  
CORPORATION OF AMERICA

One Panasonic Way  
Secaucus, New Jersey 07094

PANASONIC SALES COMPANY, DIVISION OF  
MATSUSHITA ELECTRIC OF PUERTO RICO INC.  
("PSC")

AVE. 65 de Infanteria, Km 9.5  
San Gabriel Industrial Park  
Carolina, Puerto Rico 00985  
Tel. (809) 750-4300 Fax. (809) 768-2910

C01ZAAB00U00

Printed in U.S.A.