

Ref#	Part	Description	Comments	Qty
1	71235-119N	CAP - HANDLE		
2	71473	HANDLE ASSEMBLY		
3	71537-9	CYCLONE ASSEMBLY		
4	61825	DUST CUP FLTR(STYLE DCF3)		
5	61864-1	DUST CUP ASSY - PKGD		
6	70864A-119N	HOOK - CORD		
7	53238-44	SCREW PACKAGE		
8	71479-333N	LATCH - DUST CUP		
9	61866	SPRING PACKAGE		
10	53238-27	SCREW PACKAGE		
11	72004-9	CYCLONE ASSEMBLY		
12	71785-119N	CATCH - FILTER IN PLACE		
13	61867	SPRING PACKAGE		
14	71451-119N	CYCLONE		
15	71475	GASKET - CYCLONE		
	72004-1	CYCLONE ASSEMBLY		
	71537-1	CYCLONE ASSEMBLY		

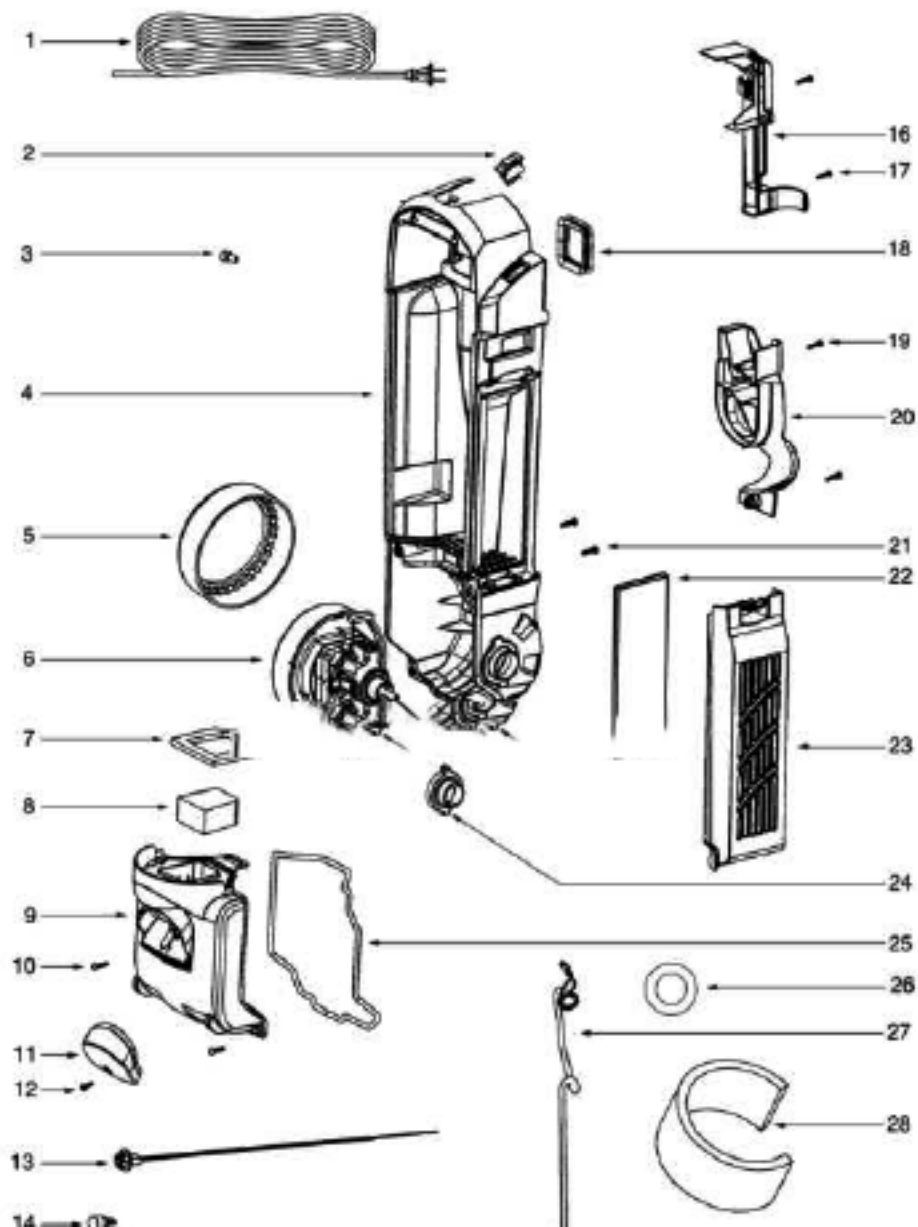

Ref#	Part	Description	Comments	Qty
1	38680-29	SUPPLY CORD & TERMINAL AS		
2	38455-1	SWITCH - ROCKER		
3	60192-1	WIRE SPLICE 5		
4	72126B	REAR HOUSING ASSEMBLY		
5	71649	GASKET - MOTOR CAN (Eumek		
6	60261-11	MOTOR ASSEMBLY - PACKAGED		
7	71483	GASKET - DIRT CUP LOWER		
8	71480	FILTER - PRE-MOTOR		
9	61863-8	MOTOR COVER ASSY - PACKAG		
11	71460-313N	LENS - HEADLAMP		
12	53238-44	SCREW PACKAGE		
13	70701-2	SOCKET & TERMINAL ASSY		
14	57940-2	LAMP - HEADLIGHT		
15	39252-1	THERMOSTAT & TERMINAL ASS		
16	72127	SWITCH COVER ASSEMBLY		
18	71482	GASKET - INTAKE		
20	71455-119N	TOOL PACK - LOWER		
21	53238-27	SCREW PACKAGE		
22	61845	MICRON FILTER INSERT-STYL		
23	72103-4	MICRON FLTR CVR & GRPHCS		
24	70084	BUSHING - MOTOR SUPPORT		
25	71484	GASKET - MOTOR COVER		
26	71969-1	GASKET - MOTOR HUB		
27	71465	CORD - JUMPER		
28	72224-1	FOAM - SOUND		
29	70651-1	TUBE - FLEXIBLE		
30	72167	PLUG		

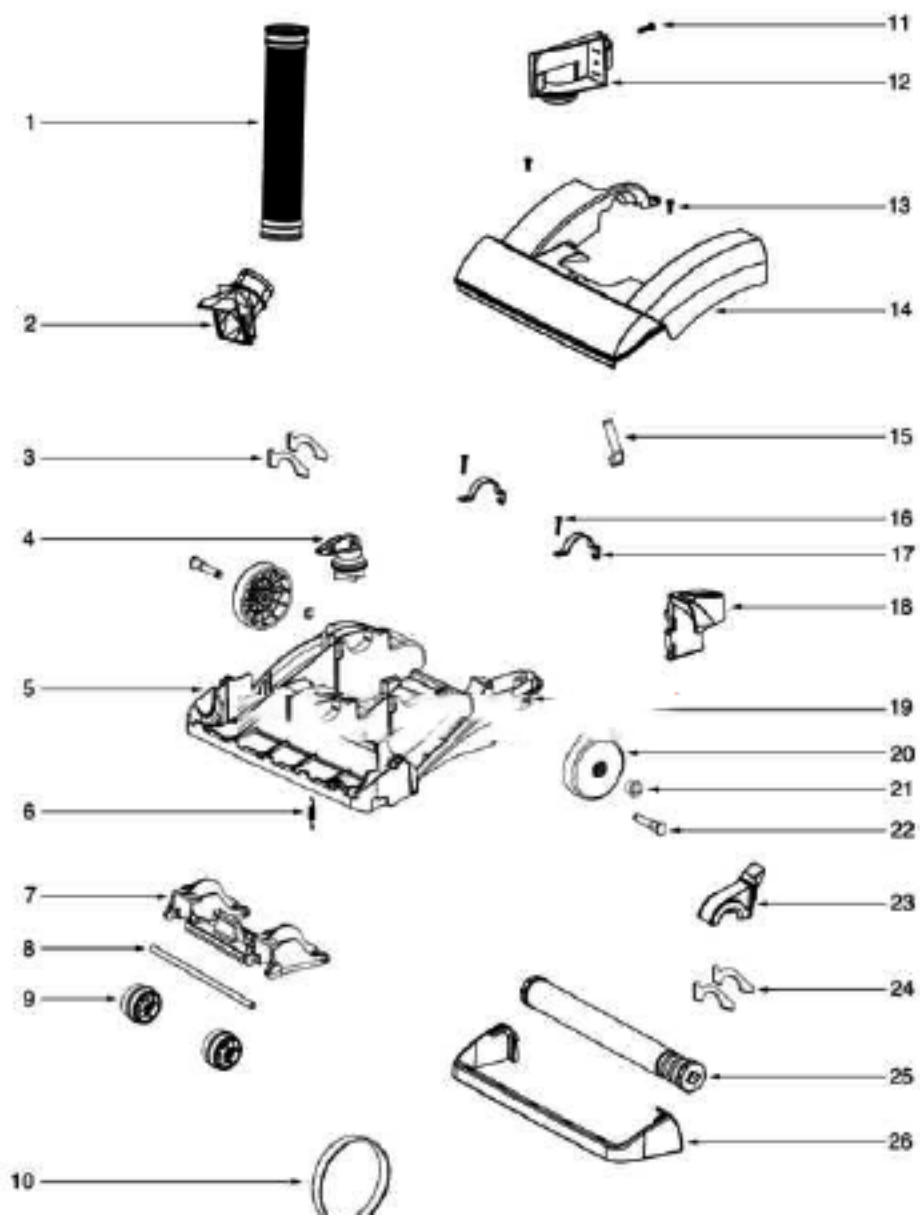

Ref#	Part	Description	Comments	Qty
1	71466	BASE HOSE ASSY		
2	71447-119N	BASE HOSE ASSY		
3	71673A	FELT - BASE		
4	71448-333N	KNOB - HEIGHT ADJUSTMENT		
5	61877-1	BASE ASSEMBLY - PACKAGED		
6	54943	SPRING PACKAGE		
7	71446-119N	CARRIAGE - WHEEL		
8	71478	AXLE - FRONT		
9	39173A-119N	WHEEL - FRONT		
10	61120A	BELT PKG ASSY-STYLE U EXT		
12	71726-119N	BASE HOSE ASSY		
13	53238-44	SCREW PACKAGE		
14	61878-8	HOOD ASSEMBLY - PACKAGED		
15	71574	SPRING - HANDLE RELEASE		
16	53238-27	SCREW PACKAGE		
17	71487	CLAMP - MOTOR		
18	71457-333N	RELEASE - HANDLE		
19	54432-1	PACKAGE - RETAINING RING		
20	72117-119N	WHEEL - REAR		
21	70004			
22	38590A	AXLE - REAR		
23	71741	BELT CAP ASSEMBLY		
24	71672A	FELT - BELT CAP		
25	61869-1	BRUSHROLL ASSY - CTND		
26	71831-355N	GUARD - FURNITURE		
	61878-2	HOOD ASSEMBLY - PACKAGED		
	61860-1	BASE ASSEMBLY - PACKAGED		
	71456-355N	GUARD - FURNITURE		
	61862-3	HOOD ASSEMBLY - PACKAGED		
	61861-2	12" DISTURBULATOR ASSY -		

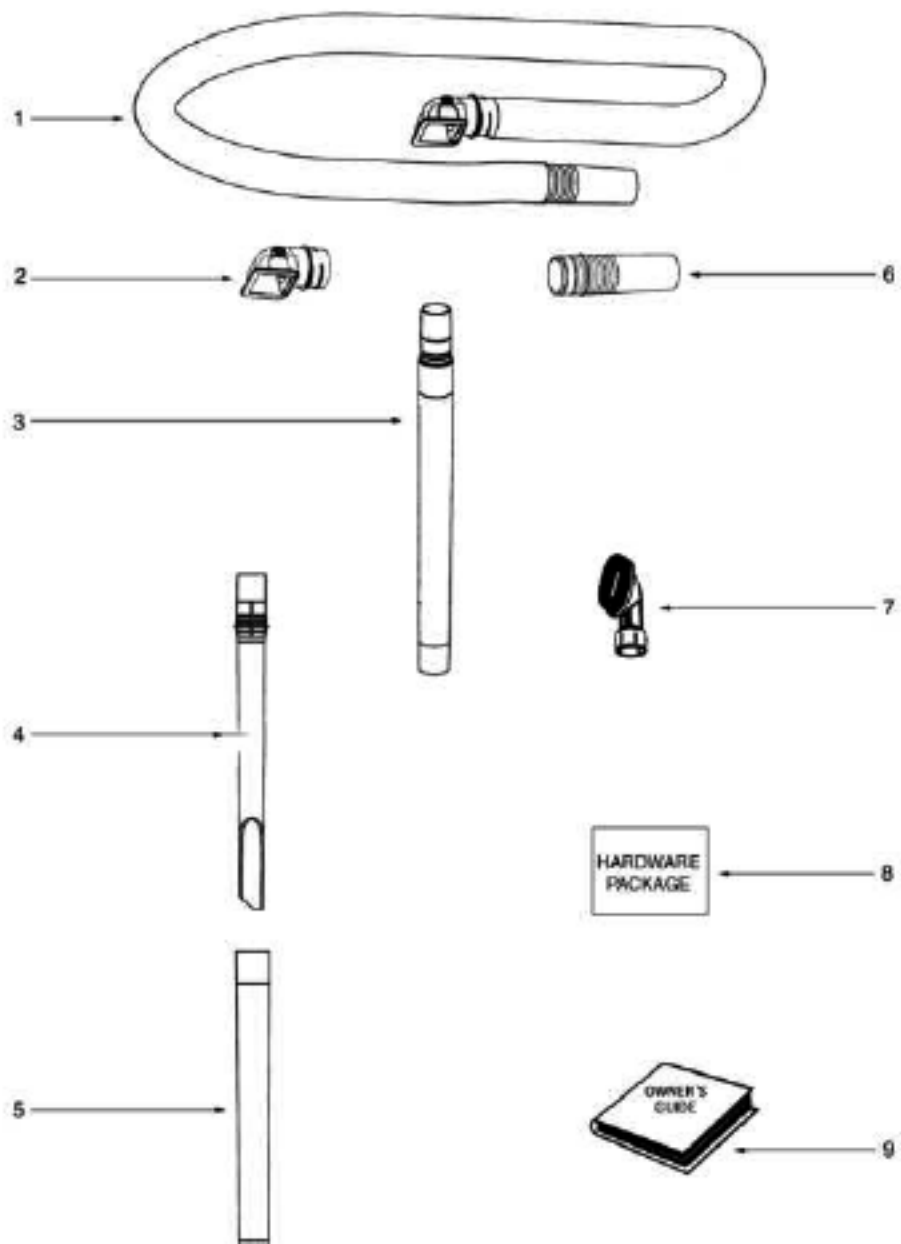

Ref#	Part	Description	Comments	Qty
1	61865-1	HOSE ASSY - CTND		
2	71725-313N	ADAPTER - HOSE		
3	71492A	NESTING WAND ASSEMBLY		
4	71956A-355N	WAND - CREVICE		
5	71973-119N	WAND - OUTER		
6	70559A-119N	COUPLING - HOSE		
7	60990-2	COMBINATION BRSH BRSTLD-C		
8	72323	PACKAGE - HARDWARE		
9	71496A	OWNER'S GUIDE		
	71496	OWNER'S GUIDE		