

This Owner's Manual is provided and hosted by [Appliance Factory Parts](#).



PANASONIC MC-V7572 Owner's Manual

[Shop genuine replacement parts for PANASONIC
MC-V7572](#)



[Find Your PANASONIC Vacuum Cleaner Parts - Select From 605 Models](#)

----- Manual continues below -----

Panasonic®

VACUUM CLEANER
Aspirateur
Aspiradora

MC-V7572

Operating Instructions
Manuel d'utilisation
Instrucciones de operación

QUICKDRAW™
TOOLS-ON BOARD WITH REF. TO-USE IOSE

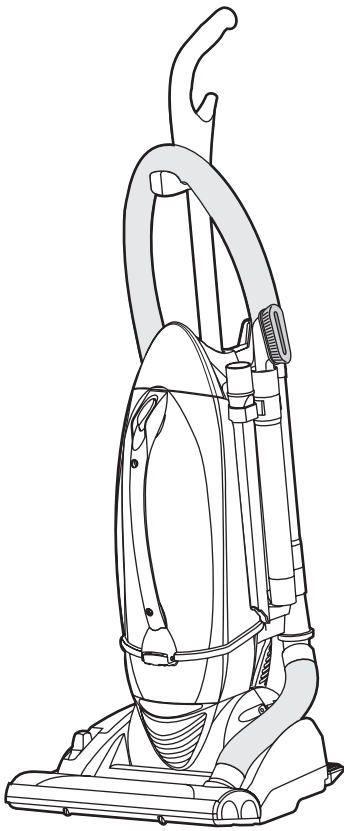

Before operating your vacuum cleaner, please read these instructions completely.

Avant d'utiliser l'appareil, il est recommandé de lire attentivement ce manuel.

Antes de usar su aspiradora, lea completamente estas instrucciones por favor.

C01ZBYS00000

CONSUMER INFORMATION

Please read **IMPORTANT SAFETY INSTRUCTIONS** on page 5 before use. Read and understand all instructions.

TO OUR VALUED CUSTOMER

We are very pleased to welcome you to the Panasonic family of products. Thank you for purchasing this product. Our intent is that you become one of our many satisfied customers.

Proper assembly and safe use of your vacuum cleaner are your responsibilities. Your vacuum cleaner is intended only for household use. The cleaner should be stored in a dry, indoor area. Read the Operating Instructions carefully for important use and safety information.

Special care is required when vacuuming certain types of carpet or floor covering. Always check the carpet or floor covering manufacturer's recommended cleaning instructions before vacuuming.

PLEASE PAY CLOSE ATTENTION TO ALL WARNING AND CAUTION STATEMENTS.



WARNING statements are designed to alert you to the possibility of personal injury, loss of human life, and/or damage to the vacuum cleaner and/or personal property if the instructions given are not followed.



CAUTION statements are designed to alert you to the possibility of damage to the vacuum cleaner and/or personal property if the instructions given are not followed.



TO AVOID ELECTRICAL SHOCK

Never vacuum damp or wet surfaces or liquids.
DO NOT store machine outdoors.
Replace worn or frayed power cord immediately.
Unplug from outlet when not in use and before servicing.

TO AVOID ACCIDENTS

Except for hand-held cleaners, keep machine on floor - not chairs, tables, steps, stairs, etc.
Store machine promptly after each use to prevent accidents such as tripping over power cord or machine.
Use machine and accessories only in a manner intended by the manufacturer.
The use of an extension cord is not recommended.

©2003 Matsushita Home Appliance Company,
Division of Matsushita Electric Corporation of America. All rights reserved.

IMPORTANT SAFETY INSTRUCTIONS

When using vacuum cleaner, basic precautions should always be followed, including the following:

READ ALL INSTRUCTIONS BEFORE USING THIS VACUUM CLEANER



WARNING

To reduce the risk of fire, electrical shock, injury:

1. **DO NOT** leave vacuum cleaner when plugged in. Unplug from outlet when not in use and before servicing.
2. To reduce the risk of fire or electric shock - **DO NOT** use outdoors or on wet surfaces.
3. **DO NOT** allow to be used as a toy. Close attention is necessary when used by or near children.
4. Use only as described in this manual. Use only manufacturer's recommended tools.
5. **DO NOT** use with damaged cord or plug. If vacuum cleaner is not working as it should, has been dropped, damaged, left outdoors, or dropped into water, return it to an authorized Panasonic Servicenter.
6. **DO NOT** carry vacuum cleaner by the dust bin handle.
7. **DO NOT** pull or carry by cord, use cord as a handle, close door on cord, or pull cord around sharp edges or corners. **DO NOT** run vacuum cleaner over cord. Keep cord away from heated surfaces.
8. **DO NOT** unplug by pulling on cord. To unplug, grasp the plug, not the cord.
9. **DO NOT** handle plug or vacuum cleaner with wet hands.
10. **DO NOT** put any objects into openings. **DO NOT** use with any opening blocked; keep free of dust, lint, hair, and anything that may reduce air flow.
11. Keep hair, loose clothing, fingers, and all parts of body away from openings and moving parts.
12. **DO NOT** pick up anything that is burning or smoking, such as cigarettes, matches, or hot ashes.
13. **DO NOT** use without dust bin and/or filters in place.
14. Turn off all controls before unplugging.
15. Use extra care when cleaning on stairs.
16. **DO NOT** use cleaner to pick up flammable or combustible liquids such as gasoline or use in areas where they may be present.
17. **DO NOT** operate cleaner without belt cover properly installed.

SAVE THESE INSTRUCTIONS

THIS VACUUM CLEANER IS INTENDED FOR HOUSEHOLD USE ONLY

Note: Before you plug in your Panasonic vacuum cleaner, make sure that the voltage indicated on the rating plate located at the back of the vacuum cleaner is the same as your local supply.

TABLE OF CONTENTS

CONSUMER INFORMATION	2
IMPORTANT SAFETY INSTRUCTIONS	5
PARTS IDENTIFICATION	10
ASSEMBLY	12
Attaching Handle	12
Power Cord	14
Tool Storage	14
FEATURES	16
Tools	16
Automatic Self Adjusting Nozzle	16
Edge Cleaning	16
Thermal Protector	18
Motor Protector	18
Carpet-Bare Floor Selector	20
TO OPERATE CLEANER	22
Power Cord	22
Using Cord Hook	22
ON-OFF Switch	24
Handle Release Pedal	24
Using Tools	26
ROUTINE CARE OF CLEANER	28
Cleaning Secondary Foam Filter	28
Replacing HEPA Exhaust Filter	30
Dust Bin Cleaning	32
Filter Changing/Cleaning	34
Replacing Belt	36
Replacing Headlight Bulb	38
Cleaning Agitators	40
Cleaning Exterior and Tools	40
Removing Clogs	42
NOTES	44
BEFORE REQUESTING SERVICE	45
WARRANTY	48, 50
WHAT TO DO WHEN SERVICE IS NEEDED	52

PARTS IDENTIFICATION

Nomenclature

Identificación de piezas

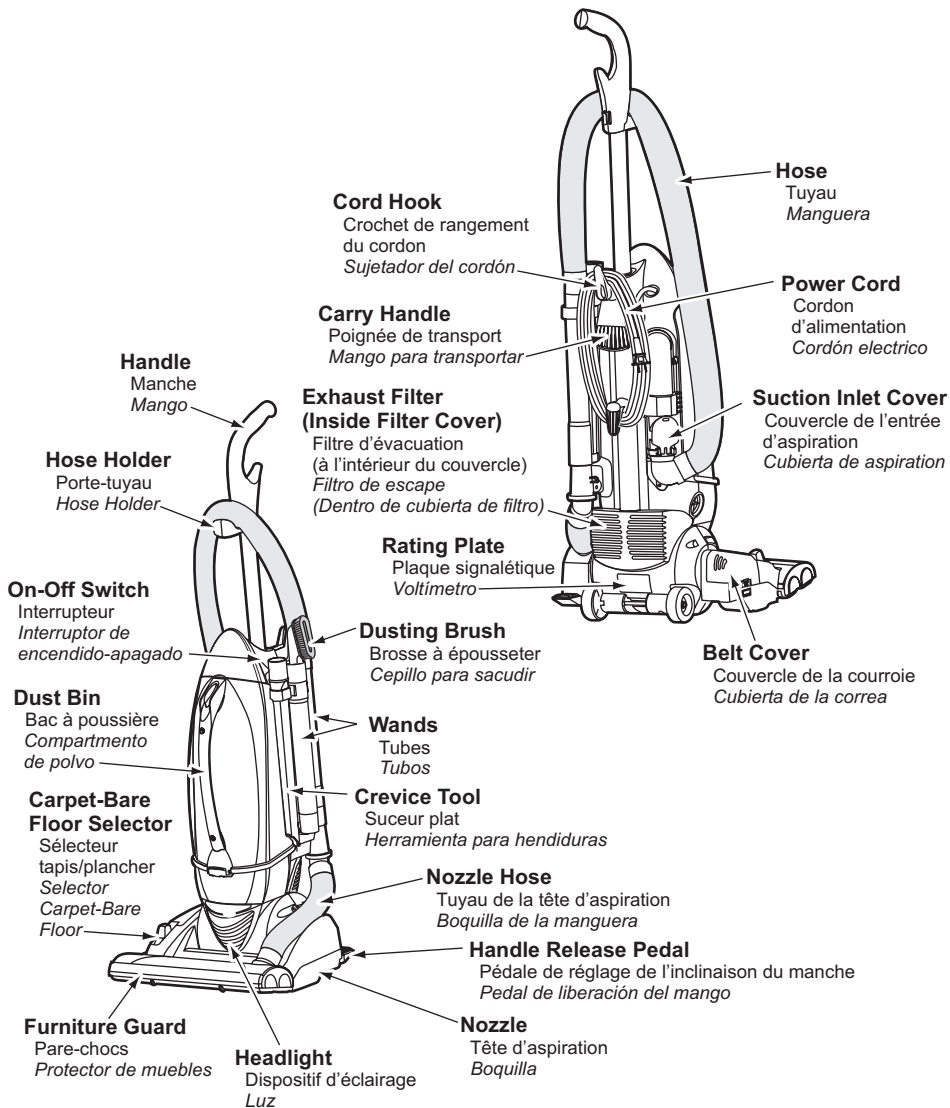

FEATURE CHART

POWER	Cord Length	Motor Protector	Bare Floor	Tool Caddy	Headlight
120 V. AC (60Hz) 12.0 A	25 ft. (7.6 m)	Yes	Yes	Yes	Yes

Tableau des caractéristiques

Alimentation	Longueur du cordon	Protecteur du moteur	Position plancher	Porte-accessoires	Dispositif d'éclairage
120 V c.a. (60 Hz) 12,0 A	7,6 m (25 pi)	Oui	Oui	Oui	Oui

Diagrama de características

<i>Voltaje</i>	<i>Extensión de cordón</i>	<i>Protector de motor</i>	<i>Uso sin alfombra</i>	<i>Caja de herramientas</i>	<i>Luz</i>
120 V AC (60Hz) 12,0 A	7,6 m (25 pi)	Si	Si	Si	Si

ASSEMBLY

Attaching Handle

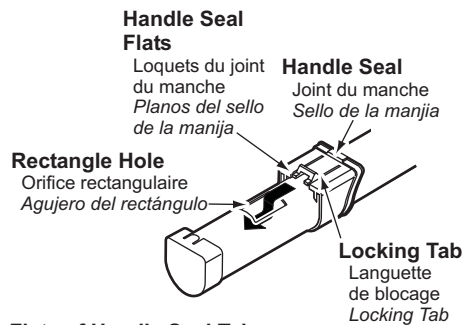
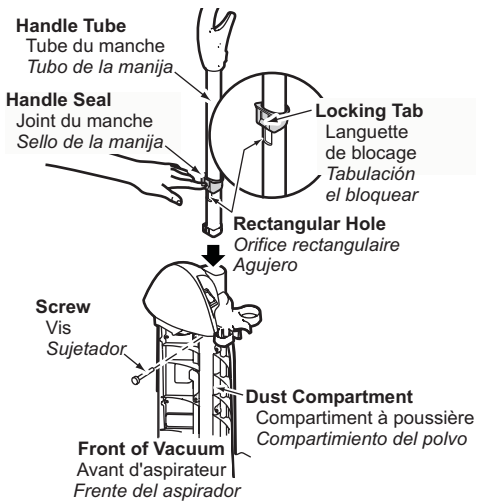

Flats of Handle Seal Tab Pressed into Rectangle Hole
Loquets du joint du manche insérés dans l'orifice rectangulaire
Los planos del sello de la manija tabulan presionado en el agujero del rectángulo

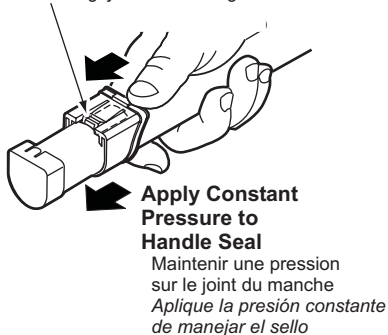

- Remove the dust bin from the vacuum cleaner body (see page 32 for Dust Bin Cleaning).
- Remove the large handle screw from the vacuum cleaner body (found top center in the back of the dust compartment).
- Grasp the handle tube and align locking tab found on the gray handle seal with rectangular hole found on the front of the handle tube.
- Press handle seal locking tab down into the rectangular hole on the handle tube to lock flats on locking tab into place (See diagram).
- Carefully insert the handle seal into the opening located on the top of the vacuum cleaner body until the handle seal is flush with the top of the vacuum cleaner.
- Push the handle tube down into the vacuum cleaner body as far as possible. When handle is inserted properly, the locking tab snaps in place and prevents the handle from coming out of the cleaner.
- Carefully align the screw hole of the handle tube with the screw hole located in the dust bin compartment on the vacuum body. Secure the handle in place with the screw as shown (see page 32 for Dust Bin Cleaning).

Power Cord

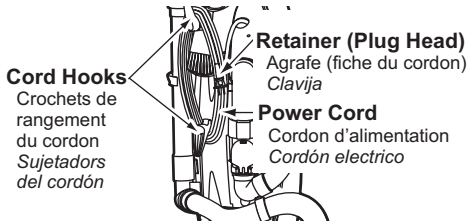

- Wrap power cord around cord hooks.
- Secure retainer (plug head) to power cord.

Tool Storage

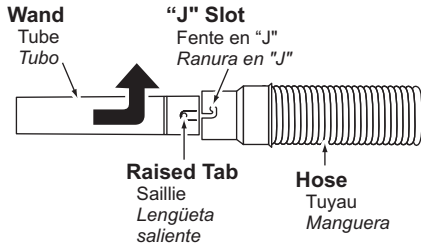

- Remove any shipping tape from the dust or belt cover.
- Attach wand to hose by aligning the two (2) raised tabs on wand with "J" slots in hose, guide tabs along grooves, twist to lock in place.
- Loop hose over hose holder on front of handle.
- Insert wand in holder, push and twist firmly onto connector pipe to assure a good connection.

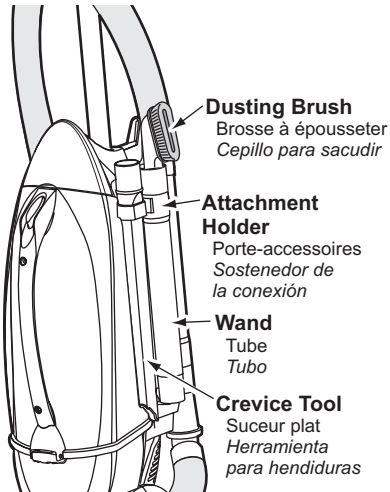

- The attachment holder provides convenient storage for tools.
- To attach holder to vacuum, insert upper tab into slot next to the On-Off switch, and push down firmly.
- Store other wand, with dusting brush on top, in round slot of attachment holder.
- Place crevice tool into rectangular slot of attachment holder.
- Refer to PARTS IDENTIFICATION section for tool location.

FEATURES

Tools

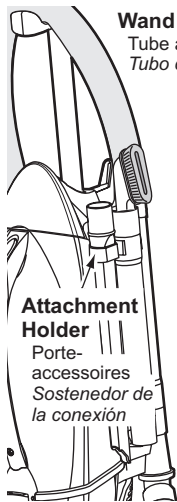

Wand with raised tabs
Tube avec saillies
Tubo con ranura en "J"

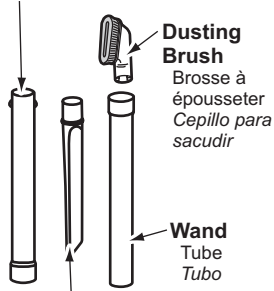

Crevice Tool
Suceur plat
Herramienta para hendiduras

➤ Your Panasonic upright vacuum cleaner is equipped with the following tools:

- Extension wand with raised tabs
- Extension wand
- Dusting Brush
- Crevice tool
- Attachment holder

Automatic Self Adjusting Nozzle

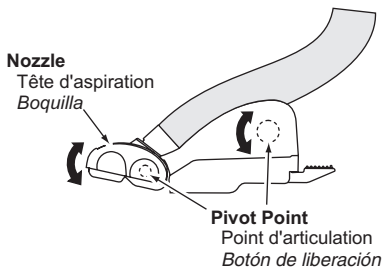

- The nozzle of your Panasonic upright vacuum cleaner automatically adjusts to any carpet pile height.
- Feature allows nozzle to float evenly over carpet pile surfaces.
- No manual adjustments required.

Edge Cleaning

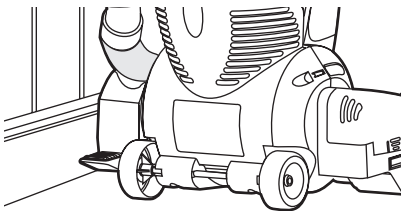

Thermal Protector

- If a clog prevents the normal flow of air to the motor, the thermal protector turns the motor off automatically to allow the motor to cool in order to prevent possible damage to the vacuum.
- During this time the headlight remains on.
- To correct problem, turn off and unplug vacuum, remove clogs, and/or clean/replace filters.
- Empty dust bin if necessary.
- Wait approximately thirty (30) minutes, plug vacuum in, turn on to see if thermal protector has reset. Thermal protector will not reset if vacuum is not turned off even if vacuum cools down.

Motor Protector

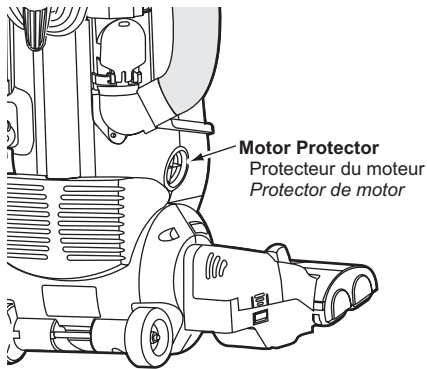

- Motor protector by-pass automatically opens to provide cooling air to motor when a clog prevents the normal air flow. The motor protector by-pass valve may also open when the dust bin is full.
- Motor protector may open when using tools.
- If motor protector opens, the vacuum will make a slightly different sound.

Note: Do not block motor protector.

Carpet-Bare Floor Selector

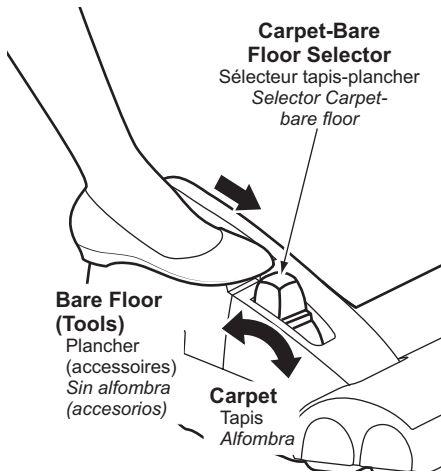

- Selector should be placed in **BARE FLOOR (TOOLS)** position when using cleaner on bare floors and when using tools.
- The agitators do not rotate in the **BARE FLOOR (TOOLS)** position.
- Selector should be placed in **CARPET** position when using cleaner on carpeted floors.
- To operate, place handle in upright position. Step on Carpet-Bare Floor selector.
- Rotate selector to the rear position **BARE FLOOR (TOOLS)**.
- To resume carpet cleaning rotate selector forward to **CARPET** position.
- Take care when selecting either position to ensure selector is pushed as **fully and quickly** as possible to desired position.

TO OPERATE CLEANER

Power Cord

NOTE: To reduce the risk of electrical shock, this vacuum has a polarized plug, one blade is wider than the other. This plug will fit in a polarized outlet only one way. If the plug does not fit fully in the outlet, reverse the plug. If it still does not fit, contact a qualified electrician to install the proper outlet. **DO NOT CHANGE THE PLUG IN ANY WAY.** Only use outlets near the floor.

Using Cord Hook

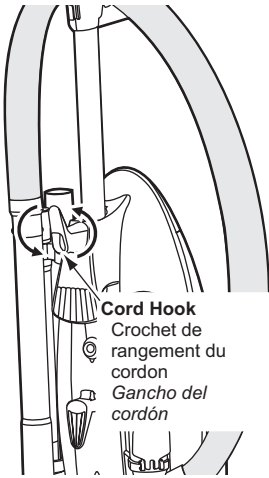

1)

- Detach plug head from power cord.
- Rotate cord hook down to release cord.

2)

- Return the cord hook to the upright position before attempting to rewind the cord.

ON-OFF Switch

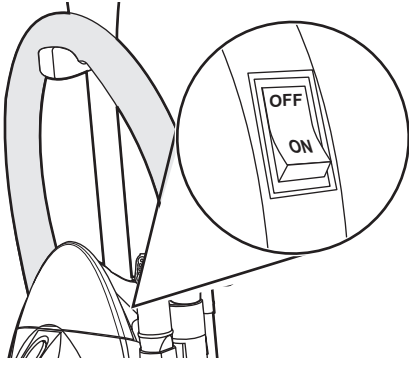

- Ensure ON-OFF switch is OFF.
- Plug the power cord into 120V outlet.
- ON position turns vacuum on.
- OFF position turns vacuum off.

Handle Release Pedal

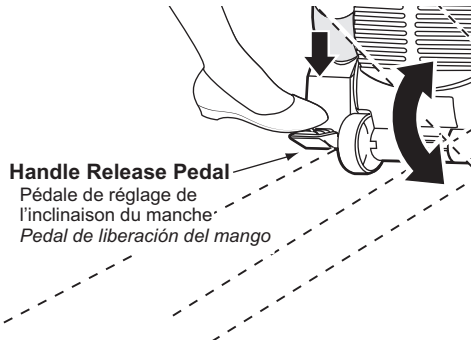

Handle Release Pedal
Pédale de réglage de
l'inclinaison du manche
Pedal de liberación del mango

- Step on handle release pedal to change handle position.
- Move vacuum to upright position for storage and tool use.
- Move vacuum to middle position for normal use.
- Use low position for cleaning under furniture.

Using Tools

Carpet-Bare Floor Selector Sélecteur tapis/plancher Selector Carpet-Bare Floor

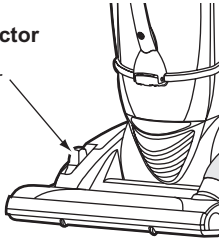

➤ Always place carpet-bare floor selector in BARE FLOOR (TOOLS) position when using tools.

➤ Remove wand from holder by twisting and pulling up.

➤ The tools can be attached to hose, wand(s) or crevice tool.

➤ For extended reach, connect the extra wand to extension wand and hose. Firmly push wands together for secure fit.

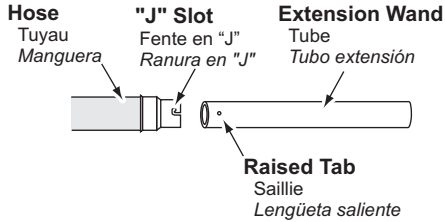

➤ DO NOT overextend your reach with hose as it could tip vacuum.

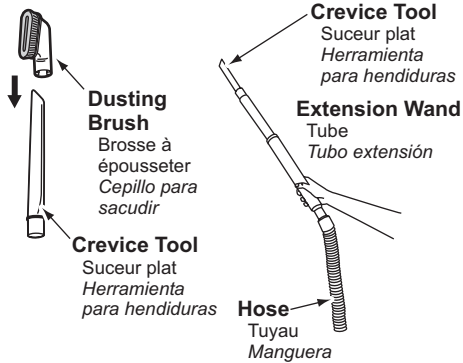

➤ The Crevice Tool may be used on the following items:

- Furniture
- Cushions
- Drapes
- Stairs
- Walls

➤ The Dusting Brush may be used on the following items:

- Furniture
- Drapes
- Stairs
- Walls

Note: Always clean tools before using

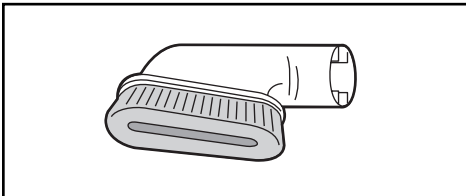
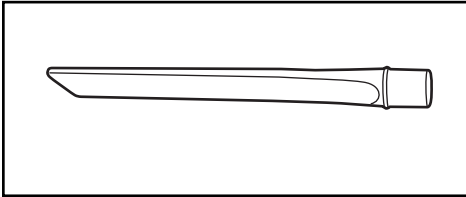

ROUTINE CARE OF CLEANER

Performing the following tasks will keep your new Panasonic vacuum cleaner operating at peak performance levels and will ensure these high levels for years to come. Check the **BEFORE REQUESTING SERVICE** section in this manual for recommendations on performing some of these tasks to help solve various problems that may occur. Always unplug vacuum before servicing.

Cleaning Secondary Foam Filter

**Secondary
Foam Filter**
Filtre secondaire
en mousse
Filtro secundario
espuma y caucho.

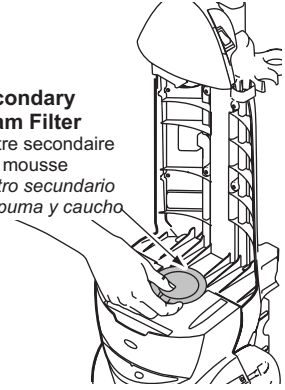

- Secondary foam filter protects motor.
- Check filter frequently and clean when dirty.
- Remove dust bin as outlined in the **DUST BIN CLEANING** section.
- Remove secondary filter from vacuum cleaner.
- Wash secondary filter in warm soapy water, rinse and dry thoroughly by squeezing the filter in your hands and letting it air dry.
 - DO NOT wash in dishwasher.
 - DO NOT install damp.
- Replace dry secondary filter. Press filter onto tabs to secure the filter in place. Ensure filter is properly installed over filter opening.
- Replace dust bin as outlined in the **DUST BIN CLEANING** section.

Replacing HEPA Exhaust Filter

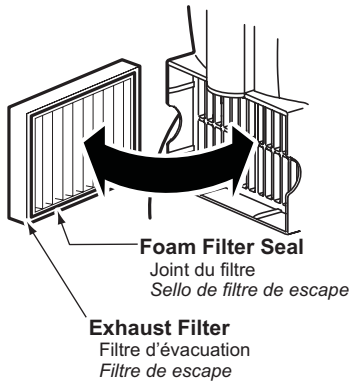
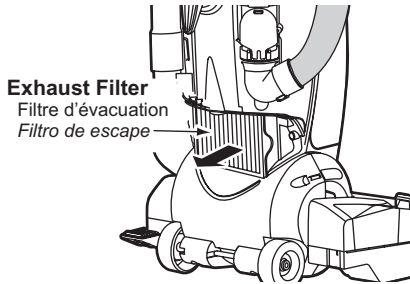
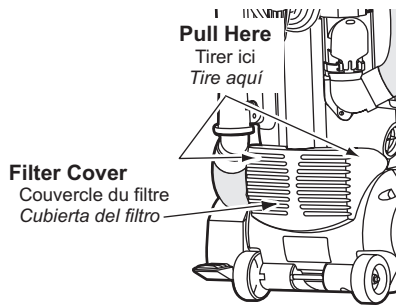

- The HEPA exhaust filter removes dirt from recirculated air.
 - Check filter after emptying dust bin. Replace when dirty.
 - To remove, pull out on both sides of the exhaust filter cover.
 - Grasp the exhaust filter and pull out to remove.
 - Ensure foam edge of the filter is facing towards the vacuum cleaner when placing filter into dust compartment. Push only on filter frame.
 - Replace exhaust filter cover by snapping into place.
- * Filter cannot be cleaned and should be replaced at least once each year.

Dust Bin Cleaning

Release Button
Bouton de dégagement
Release Button

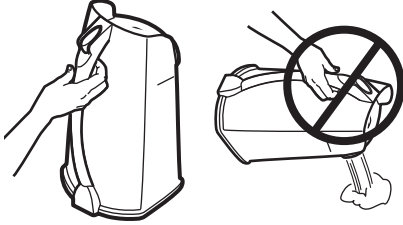
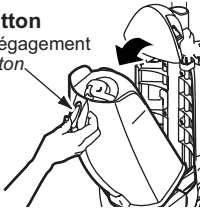

Cleaning Knob
Bouton de nettoyage
Cleaning knob

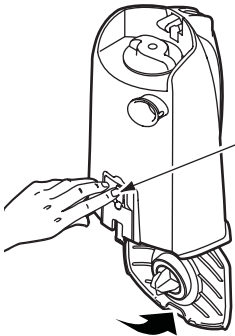

Lid release button
Bouton de dégagement
du couvercle
Lid release button

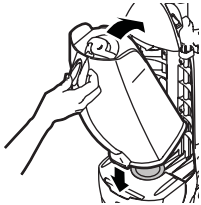

➤ Always empty the dust bin when dirt level reaches the “FULL CUP” line.

CAUTION: Never carry the vacuum cleaner by the dust bin handle. The dust bin could come out and cause damage to the vacuum cleaner or injury to yourself.

➤ Remove dust bin from cleaner by pressing release button on dust bin handle. Tilt dust bin as shown and lift out.

➤ **CAUTION:** Always carry the dust bin in the vertical position.

➤ **NEVER** carry the dust bin horizontally. Dust and dirt may spill out the inlet hole when carried incorrectly.

➤ Every time dust bin is removed, rotate cleaning knob in the counter-clockwise direction at least three complete revolutions to clean filter and maintain cleaning performance.

➤ Empty contents of dust bin into waste container by pressing the lid release button on rear of dust bin. Close bottom lid, **MAKING SURE LID IS SECURELY LATCHED.**

➤ To reinstall dust bin to cleaner align notch on bottom of dust bin and the notch in the vacuum cleaner together and tilt bin into place as shown. **MAKE SURE THAT TOP LATCHES IN PLACE.**

Filter Changing/Cleaning

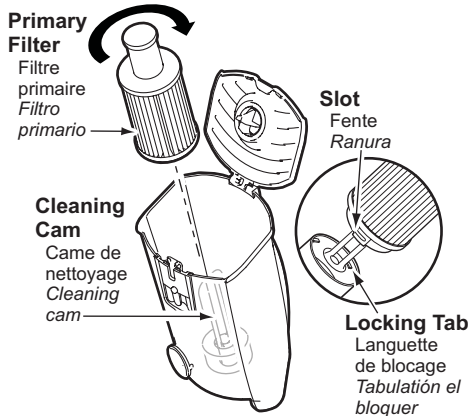
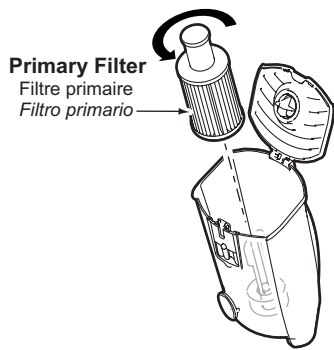

- Check primary filter frequently and clean when dirty.
- Remove the dust bin assembly as outlined in the **DUST BIN CLEANING** section and empty contents of dust bin.
- Make sure dust bin is clean before filter is removed.
- Grasp filter, rotate counter-clockwise and lift out.
- Clean primary filter by gently tapping over a trash container. Tap on several sides to ensure best cleaning. (Rinse with water only as needed).
- The filter may be cleaned by tapping it on a firm surface or by rinsing it under a faucet. Rinse with water only, do not use detergent or soap. Allow filter to dry 24 hours before putting it back into the dust bin.
- When the cleaning of the filter no longer restores vacuum suction to full power you need to replace the filter.
- Before replacing the filter it is a good idea to clean the inside of the dust bin and lid area.
- When replacing filter, carefully slide filter over cleaning cam.
- Rotate filter clockwise until slots lock onto tabs in cover.
- Close bottom lid, **MAKING SURE LID IS SECURELY LATCHED.**
- Reinstall dust bin as outlined in Dust Bin Cleaning Section.

Note: Under normal use and care, your filter can be expected to last up to 5 years.

Replacing Belt

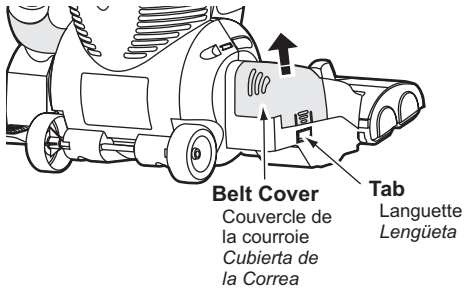

CAUTION

**BELT AND MOTOR SHAFT
MAY BE HOT!**

Make sure the vacuum has completely cooled prior to replacing belt.

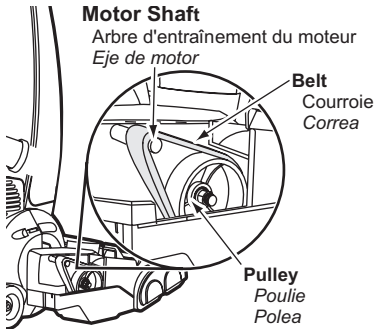

- **Ensure ON-OFF switch is OFF.**
- **Disconnect power cord from electrical outlet.**
- **Replace belt whenever a burning rubber smell caused by excessive slippage occurs.**
- **Place CARPET/BARE FLOOR selector in CARPET position.**
- **Remove belt cover by pressing on tab and lifting off belt cover.**
- **Remove worn or broken belt.**
- **Loop new belt around motor shaft and pulley; see illustration for correct belt routing.**
- **Ensure that belt is not twisted or pinched.**
- **Reinstall belt cover and snap into place.**
- **DO NOT operate cleaner without belt cover in place.**

Replacing Headlight Bulb

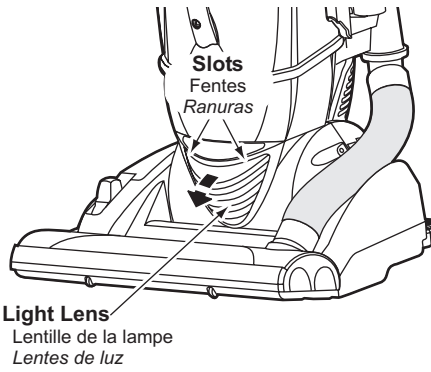

- Ensure ON-OFF switch is OFF.
- Disconnect power cord from electrical outlet.
- Press handle release pedal and rotate the handle down so the cleaner is laying flat on the floor.
- Pry out light lens at slots.
- Remove old bulb from the socket by pulling from socket.
- Replace bulb by pressing into socket.
- Only use a bulb rated 13 V AC-9 Watts.
- Reinstall light lens by snapping into place.
- Return the cleaner to the upright position.

Cleaning Agitators

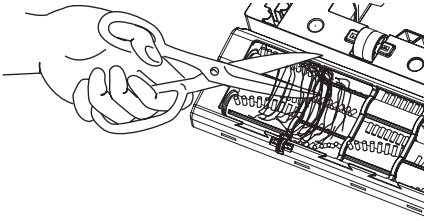

- Ensure ON-OFF switch is OFF.
- Disconnect power cord from electrical outlet.
- Clean agitators after every five uses.
- Selector should be placed in BARE FLOOR (TOOLS) position.
- Turn vacuum over.
- Cut off any carpet pile and lint entangled around agitators with a pair of scissors in the slots provided and remove.

Cleaning Exterior and Tools

- Ensure ON-OFF switch is OFF.
- Disconnect power cord from electrical outlet.
- Clean exterior using a clean, soft cloth that has been dipped in a solution of mild liquid detergent and water and wrung dry.
- DO NOT drip water on vacuum cleaner, wipe dry after cleaning.
- DO NOT clean tools in dishwasher or clothes washer.
- Wash tools in warm, soapy water, rinse and air dry.
- DO NOT use tools if they are wet.

Removing Clogs

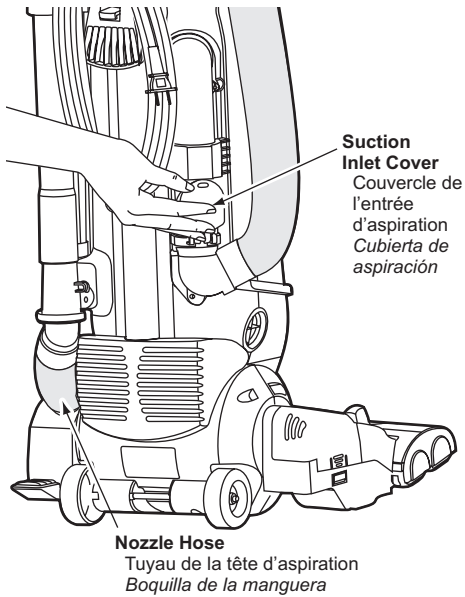

If the vacuum should become clogged:

- Ensure ON-OFF switch is OFF.
- Disconnect power cord from electrical outlet.
- Pull open suction inlet cover and remove any clogs.
- Check the nozzle hose to make sure it is free from obstructions.
- The nozzle hose may be removed at the wand attachment end in order to remove clogs.
- Check and replace any clogged filters.
- Clean agitators.

Handle Removal

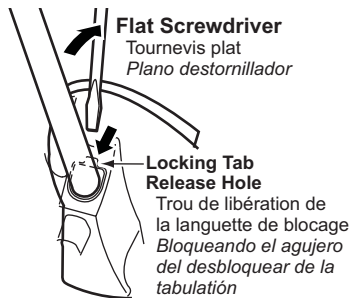

- Remove the screw that secures the handle to the vacuum.
- Insert flat screwdriver into locking tab release hole located just in front of the handle tube, pry screwdriver toward the front of the vacuum. This should release the handle locking tab allowing the handle to be pulled from the vacuum.
- Remove handle assembly by pulling straight out of vacuum.

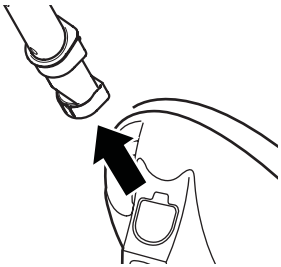

BEFORE REQUESTING SERVICE



WARNING *Electrical Shock or Personal Injury Hazard.*

Disconnect the electrical supply before servicing or cleaning the unit. Failure to do so could result in electrical shock or personal injury from cleaner suddenly starting.

Review this chart to find do-it-yourself solutions for minor performance problems. Any service needed, other than those described in these Operating Instructions, should be performed by an authorized service representative.

PROBLEM	POSSIBLE CAUSE	POSSIBLE SOLUTION
Cleaner will not run.	<ol style="list-style-type: none"> 1. Unplugged at wall outlet. 2. ON-OFF switch not turned on. 3. Tripped thermal protector. 4. Tripped circuit breaker/blown fuse at household service panel. 	<ol style="list-style-type: none"> 1. Plug in firmly. Push ON-OFF switch to ON. 2. Push ON-OFF switch to ON. 3. Unplug vacuum, wait thirty (30) minutes, plug in and switch to ON. 4. Reset circuit breaker or replace fuse.
Poor job of dirt pickup.	<ol style="list-style-type: none"> 1. Full or clogged dust bin. 2. Broken belt. 3. Carpet-bare floor setting incorrect. 4. Clogged hose or nozzle. 5. Hose not inserted fully. 6. Worn agitator. 7. Hole in hose. 8. Dust bin improperly installed. 9. Belt not installed on motor shaft. 	<ol style="list-style-type: none"> 1. Empty dust bin. 2. Replace belt. 3. Set in the correct position. 4. Clean hose or nozzle area. 5. Insert hose. 6. Replace agitator. 7. Replace hose. 8. Properly install dust bin. 9. Install belt on motor shaft.
Light will not work.	<ol style="list-style-type: none"> 1. Burned out light bulb. 	<ol style="list-style-type: none"> 1. Replace light bulb.

WARRANTY

Panasonic Vacuum Cleaner Limited Warranty

Panasonic Home and Commercial Products Company (collectively referred to as "the warrantor") will repair this product with new or refurbished parts free of charge, in the U.S.A. or Puerto Rico for one (1) year from the date of original purchase in the event of a defect in materials or workmanship.

This Limited Warranty Excludes both Labor and Parts for the following items which require normal replacement: Disposable Dust Bag, Filters, Belts, Light Bulbs, Agitator Brushes and Batteries (if supplied).

Carry-in or mail-in service in the U.S.A. can be obtained during the warranty period by contacting a Panasonic Services Company (PASC) Factory Servicenter listed in the Servicenter Directory. Or call, toll free, 1-800-211-PANA (7262) to locate a PASC Authorized Servicenter. Carry-in or mail-in service in Puerto Rico can be obtained during the warranty period by calling the local Panasonic Sales Company telephone number listed in the Servicenter Directory.

This warranty is extended only to the original purchaser. A purchase receipt or other proof of date of original purchase will be required before warranty performance is rendered.

This warranty only covers failures due to defects in materials and workmanship which occur during normal use and does not cover damages which occur in shipment, or failures which are caused by products not supplied by the warrantor, or failures which result from accident, misuse, abuse, neglect, mishandling, misapplication, faulty installation, improper operation or maintenance, alteration, modification, power line surge, improper voltage supply, lightning damage, commercial use such as hotel, office, restaurant or other business or rental use of the product, or service by anyone other than a PASC Authorized Servicenter, or damage that is attributable to acts of God.

LIMITS AND EXCLUSIONS:

There are no express warranties except as listed above.

THE WARRANTOR SHALL NOT BE LIABLE FOR INCIDENTAL OR CONSEQUENTIAL DAMAGES RESULTING FROM THE USE OF THIS PRODUCT, OR ARISING OUT OF ANY BREACH OF THIS WARRANTY. ALL EXPRESS AND IMPLIED WARRANTIES, INCLUDING THE WARRANTIES OF MERCHANTABILITY AND FITNESS FOR A PARTICULAR PURPOSE, ARE LIMITED TO THE APPLICABLE WARRANTY PERIOD SET FORTH ABOVE.

Some states do not allow the exclusion or limitation of incidental or consequential damages, or limitations on how long an implied warranty lasts, so the above exclusions or limitations may not apply to you.

This warranty gives you specific legal rights and you may also have other rights which vary from state to state. If a problem with this product develops during or after the warranty period, you may contact your dealer or Servicenter. If the problem is not handled to your satisfaction, then write to the Consumer Affairs Department at the listed address on the back cover.

WARRANTY

Panasonic Canada Inc.
5770 Ambler Drive, Mississauga, Ontario L4W 2T3

PANASONIC PRODUCT - LIMITED WARRANTY

Panasonic Canada Inc. warrants this product to be free from defects in material and workmanship and agrees to remedy any such defect for a period as stated below from the date of original purchase.

Vacuum Cleaner - One (1) year, parts and labour

LIMITATIONS AND EXCLUSIONS

This warranty does not apply to products purchased outside Canada or to any product which has been improperly installed, subjected to usage for which the product was not designed, misused or abused, damaged during shipping, or which has been altered or repaired in any way that affects the reliability or detracts from the performance, nor does it cover any product which is used commercially. Parts such as disposable dust bags, filters, belts, light bulbs and agitator brushes are also excluded from coverage under this warranty.

This warranty is extended to the original end user purchaser only. A purchase receipt or other proof of date of original purchase is required before warranty service is performed.

THIS EXPRESS, LIMITED WARRANTY IS IN LIEU OF ALL OTHER WARRANTIES, EXPRESS OR IMPLIED, EXCLUDING ANY IMPLIED WARRANTIES OF MERCHANTABILITY OR FITNESS FOR A PARTICULAR PURPOSE. IN NO EVENT WILL PANASONIC CANADA INC. BE LIABLE FOR ANY SPECIAL, INDIRECT OR CONSEQUENTIAL DAMAGES.

In certain instances, some jurisdictions do not allow the exclusion or limitation of incidental or consequential damages, or the exclusion of implied warranties, so the above limitations and exclusions may not be applicable.

WARRANTY SERVICE

For product operation and information assistance, please contact your Dealer or our Customer Care Centre at:
Telephone #: (905) 624-5505 Fax #: (905) 238-2360 Web: www.panasonic.ca

For product repairs, please contact one of the following:

- Your Dealer who will inform you of an authorized Servicentre nearest you.
- Our Customer Care Centre at (905) 624-5505 or www.panasonic.ca
- A Panasonic Factory Servicentre listed below:

Richmond, British Columbia

Panasonic Canada Inc.
12111 Riverside Way
Richmond, BC V6W 1K8
Tel: (604) 278-4211
Fax: (604) 278-5627

Calgary, Alberta

Panasonic Canada Inc.
6835-8th St. N.E.
Calgary, AB T2E 7H7
Tel: (403) 295-3955
Fax: (403) 274-5493

Mississauga, Ontario

Panasonic Canada Inc.
5770 Ambler Dr.
Mississauga, ON L4W 2T3
Tel: (905) 624-8447
Fax: (905) 238-2418

Lachine, Québec

Panasonic Canada Inc.
3075, rue Louis A. Amos
Lachine, QC H8T 1C4
Tel: (514) 633-8684
Fax: (514) 633-8020

IF YOU SHIP THE PRODUCT TO A SERVICENTRE

Carefully pack and send prepaid, adequately insured and preferably in the original carton.
Include details of the defect claimed, and proof of date of original purchase.

WHAT TO DO WHEN SERVICE IS NEEDED

If your Panasonic Vacuum Cleaner needs service, look in the yellow pages of the telephone book under HOME APPLIANCE SERVICE for your nearest Panasonic Services Company ("PASC") Factory Servicenter, or PASC authorized Servicenter, or call, 1-800-211-PANA (7262) toll free to find a convenient servicenter. **DO NOT send the product to the Executive or Regional Sales offices. They are NOT equipped to make repairs.**

If you ship the product

Carefully pack and send it prepaid, adequately insured and preferably in the original carton. Attach a postage-paid letter to the outside of the carton, which contains a description of your complaint. **DO NOT send the product to the Executive or Regional Sales Offices. They are NOT equipped to make repairs.**

PANASONIC HOME & COMMERCIAL PRODUCTS COMPANY
DIVISION OF MATSUSHITA ELECTRIC CORPORATION OF AMERICA

One Panasonic Way
Secaucus, New Jersey 07094
World Wide Web Address
<http://www.panasonic.com>

What to do when service is needed Service après-vente (Canada)

WARRANTY SERVICE

For product operation and information assistance, please contact your Dealer or our Customer Care Centre at:

Telephone #: (905) 624-5505

Fax #: (905) 238-2360

Web: www.panasonic.ca

For product repairs, please contact one of the following:

- Your Dealer who will inform you of an authorized Servicenter nearest you.
- Our Customer Care Centre at (905) 624-5505 or www.panasonic.ca
- A Panasonic Factory Servicenter listed on warranty page.

RÉPARATION SOUS GARANTIE

Pour de l'aide sur le fonctionnement de l'appareil ou pour toute demande d'information, veuillez contacter votre détaillant ou notre service à la clientèle au :

N° de téléphone : (905) 624-5505 N° de télécopieur : (905) 238-2360 Site Internet : www.panasonic.ca

Pour la réparation des appareils, veuillez consulter :

- votre détaillant, lequel pourra vous renseigner sur le centre de service agréé le plus près de votre domicile ;
- notre service à la clientèle au (905) 624-5505 ou www.panasonic.ca ;
- un de nos centres de service indiqués sur la page de garantie.

Quando necesita servicio

Si su aspiradora Panasonic necesita servicio, busque el Centro de Servicio Panasonic o un Centro de Servicio PASC autorizado más cercano bajo "Servicio de Electrodomésticos" en las páginas amarillas de la guía de teléfonos o llame gratis al 1-800-211-PANA (7262) para encontrar un centro de servicio conveniente. **No mande el producto a las Executive o Regional Sales Offices. No están equipadas para arreglar estos productos.**

Si manda el producto

Empaquete con cuidado en el cartón original si posible y mándelo prepagado y con seguro suficiente. Ponga una carta con sellos en la que describe su problema con el producto en el exterior del cartón. **No mande el producto a las Executive o Regional Sales Offices. No están equipadas para arreglar estos productos.**

PANAMEX COMPANY
DIVISION OF MATSUSHITA ELECTRIC CORPORATION OF AMERICA

One Panasonic Way
Secaucus, New Jersey 07094
World Wide Web Address
<http://www.panasonic.com>

AC01ZBYSZ000
C01ZBYS00000

Printed in Mexico
Impreso en Mexico
Imprimé au Mexique