

This Owner's Manual is provided and hosted by [Appliance Factory Parts](http://www.appliancefactoryparts.com).

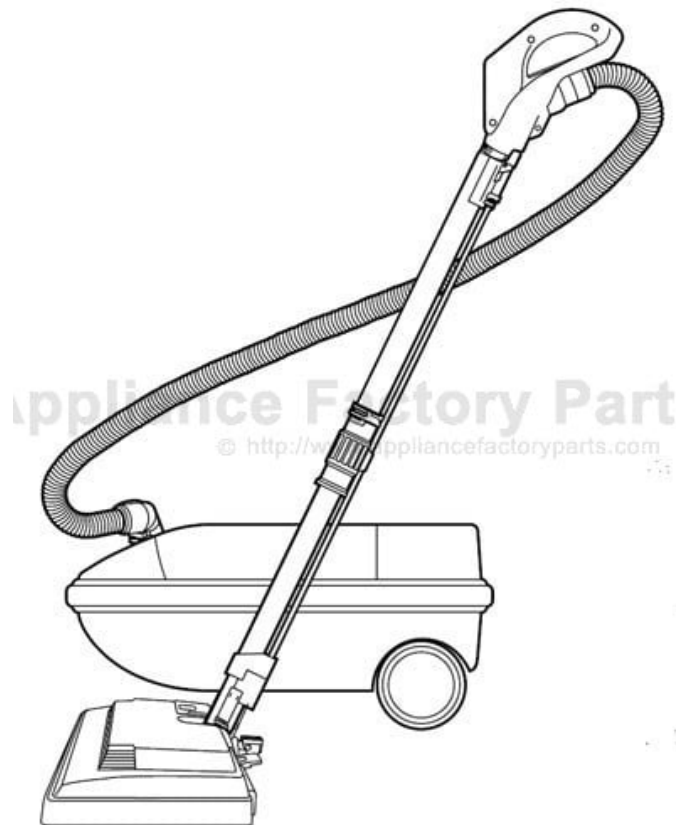

# PANASONIC MC-V9638 Owner's Manual

[Shop genuine replacement parts for PANASONIC  
MC-V9638](#)



[Find Your PANASONIC Vacuum Cleaner Parts - Select From 605 Models](#)

----- Manual continues below -----

# Panasonic®

VACUUM CLEANER

Aspirateur

Aspiradora

## MC-V9638

Operating Instructions

Manuel d'utilisation

*Instrucciones de operación*

*Performance* **Plus**

P L A T I N U M

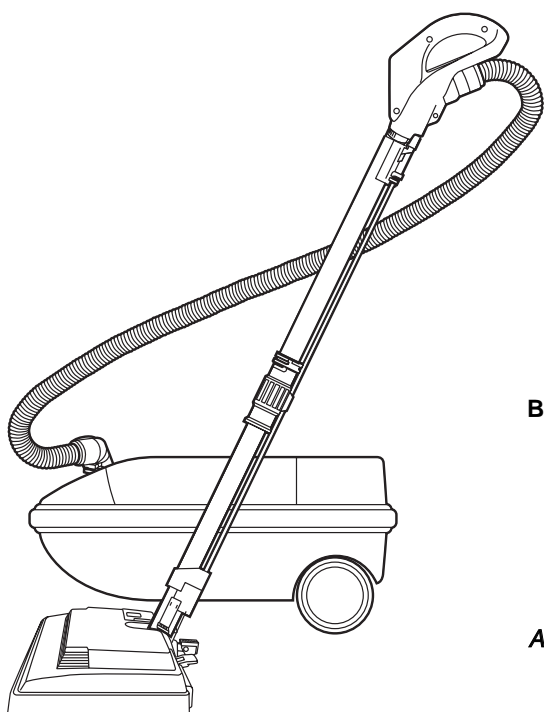

**Before operating your vacuum cleaner, please read these instructions completely.**

Avant d'utiliser l'appareil, il est recommandé de lire attentivement ce manuel.

***Antes de usar su aspiradora, lea completamente estas instrucciones por favor.***

C01ZBMW30U00

# CONSUMER INFORMATION

Please read **IMPORTANT SAFETY INSTRUCTIONS** on page 5 before use. Read and understand all instructions.

## TO OUR VALUED CUSTOMER

We are very pleased to welcome you to the Panasonic family of products. Thank you for purchasing this product. Our intent is that you become one of our many satisfied customers.

**Proper assembly and safe use of your vacuum cleaner are your responsibilities. Your vacuum cleaner is intended only for household use. The cleaner should be stored in a dry, indoor area. Read the Operating Instructions carefully for important use and safety information.**

**Special care is required when vacuuming certain types of carpet or floor covering. Always check the carpet or floor covering manufacturer's recommended cleaning instructions before vacuuming.**

## PLEASE PAY CLOSE ATTENTION TO ALL WARNING AND CAUTION STATEMENTS.



**WARNING** statements are designed to alert you to the possibility of personal injury, loss of human life, and/or damage to the vacuum cleaner and/or personal property if the instructions given are not followed.



**CAUTION** statements are designed to alert you to the possibility of damage to the vacuum cleaner and/or personal property if the instructions given are not followed.



### **TO AVOID ELECTRICAL SHOCK**

Never vacuum damp or wet surfaces or liquids.  
DO NOT store machine outdoors.  
Replace worn or frayed power cord immediately.  
Unplug from outlet when not in use and before servicing.

### **TO AVOID ACCIDENTS**

Except for hand-held cleaners, keep machine on floor - not chairs, tables, steps, stairs, etc.  
Store machine promptly after each use to prevent accidents such as tripping over power cord or machine.  
Use machine and accessories only in a manner intended by the manufacturer.  
The use of an extension cord is not recommended.

©2004 Matsushita Home Appliance Company,  
Division of Matsushita Electric Corporation of America. All rights reserved.

# IMPORTANT SAFETY INSTRUCTIONS

When using your vacuum cleaner, basic precautions should always be followed

READ ALL INSTRUCTIONS BEFORE USING THIS VACUUM CLEANER



## WARNING

To reduce the risk of fire, electrical shock, injury:

1. **DO NOT** leave vacuum cleaner plugged in when not in use. Unplug from outlet when not in use and before servicing.
2. To reduce the risk of fire, or electric shock - **DO NOT** use outdoors or on wet surfaces.
3. **DO NOT** allow to be used as a toy. Close attention is necessary when used by or near children.
4. Use only as described in this manual. Use only manufacturer's recommended attachments.
5. **DO NOT** use with damaged cord or plug. If vacuum cleaner is not working as it should, or if it has been dropped, damaged, left outdoors, or dropped into water, return it to an Authorized Panasonic Service Center.
6. **DO NOT** pull or carry by cord, use cord as a handle, close door on cord, or pull cord around sharp edges or corners. Do not run vacuum cleaner over cord. Keep cord away from heated surfaces.
7. Hold plug when rewinding onto cord reel. **DO NOT** allow plug to whip when rewinding.
8. **DO NOT** unplug by pulling on cord. To unplug, grasp the plug, not the cord.
9. **DO NOT** handle plug or vacuum cleaner with wet hands.
10. **DO NOT** put any objects into openings. **DO NOT** use with any opening blocked; keep free of dust, lint, hair, and anything that may reduce air flow.
11. Keep hair, loose clothing, fingers, and all parts of body away from openings and moving parts.
12. **DO NOT** pick up anything that is burning or smoking, such as cigarettes, matches, or hot ashes.
13. **DO NOT** use without dust bag and/or filters in place.
14. Turn off all controls before unplugging.
15. Use extra care when cleaning on stairs.
16. **DO NOT** use cleaner to pick up flammable or combustible liquids such as gasoline or use in areas where they may be present.
17. **DO NOT** operate cleaner with punctured hose. The hose contains electrical wires. Replace if cut or worn. Avoid picking up sharp objects.
18. Always turn off cleaner before connecting or disconnecting the hose or Power Nozzle.

## SAVE THESE INSTRUCTIONS

**THIS VACUUM CLEANER IS INTENDED  
FOR HOUSEHOLD USE ONLY**

**Note:** Before you plug in your Panasonic vacuum cleaner, make sure that the voltage indicated on the rating plate located at the back of the vacuum cleaner is the same as your local supply.

## TABLE OF CONTENTS

CONSUMER INFORMATION .....	2
IMPORTANT SAFETY INSTRUCTIONS .....	5
PARTS IDENTIFICATION .....	10-12
ASSEMBLY .....	14
Wands .....	14
Power Nozzle .....	14
Canister .....	16
Hood .....	16
Hose .....	16
FEATURES .....	18
Overload Protector .....	18
Performance Indicator .....	18
Suction Control .....	20
Hose Swivel .....	20
TO OPERATE CLEANER .....	22
Power Cord .....	22
ON-OFF Switch .....	24
Handle Adjustments .....	24
Suggested Pile Height Settings .....	24
Using Tools .....	26, 28
Vacuuming Tips .....	30
ROUTINE CARE OF CLEANER .....	32
Changing Dust Bag .....	32
Motor Safety Filter Cleaning .....	34
Cleaning Exterior and Tools .....	34
POWER NOZZLE CARE .....	36
Replacing Headlight Bulb .....	36
Removing Belt .....	38
Replacing Belt .....	40
Brush Servicing .....	42
Agitator Assembly .....	44
Removing Clogs .....	44
BEFORE REQUESTING SERVICE .....	49
WARRANTY .....	52,54
WHAT TO DO WHEN SERVICE IS NEEDED .....	56

# PARTS IDENTIFICATION

## Nomenclature Identificación de piezas

### Power Nozzle

Tête motorisée

Power Nozzle

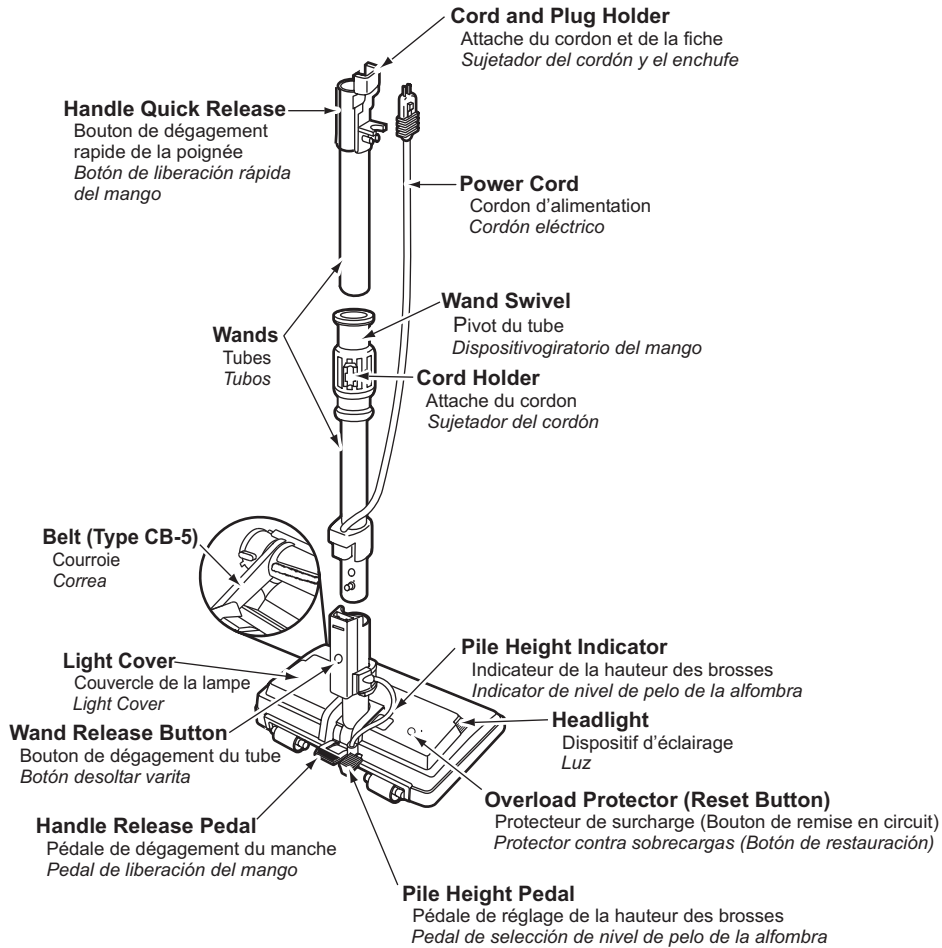

# PARTS IDENTIFICATION

## Nomenclature

### Identificación de piezas

#### Canister

Chariot

Receptáculo

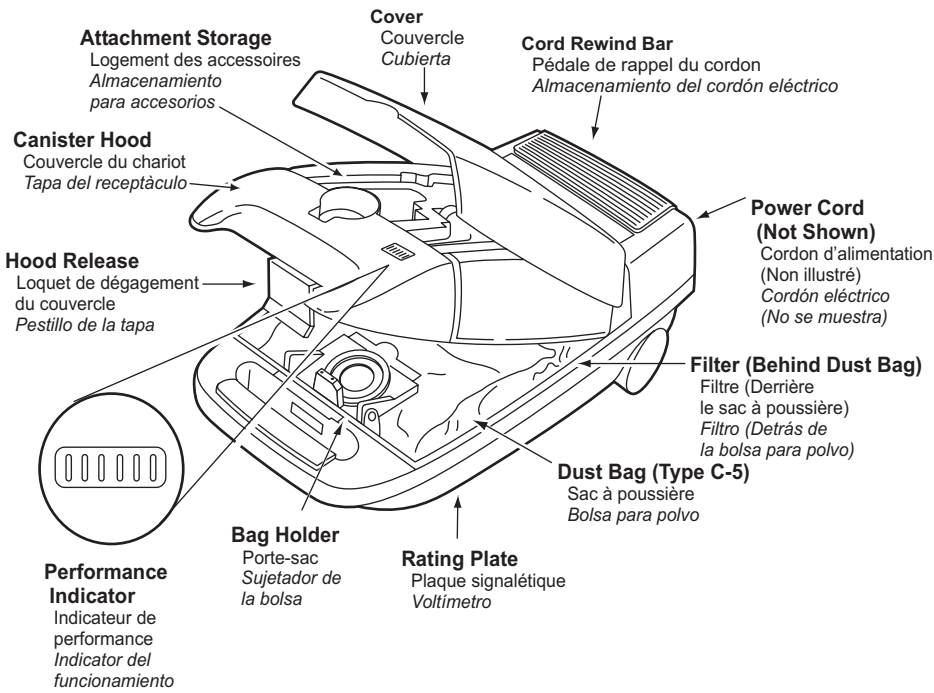

## PARTS IDENTIFICATION

### Nomenclature *Identificación de piezas*

#### Hose Tuyau *Manguera*

##### 3-Way On/Off Switch (Off/Floor/Carpet)

Interrupteur à trois positions (Arrêt/Plancher/Moquette)  
Interruptor de encendido/apagado de tres posiciones  
(Apagado/Piso expuesto/Alfombra)

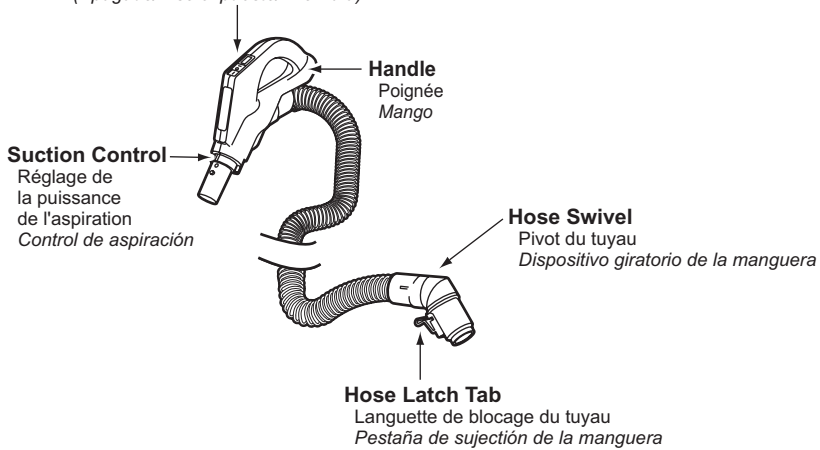

#### Tools Accessoires *Herramientas*

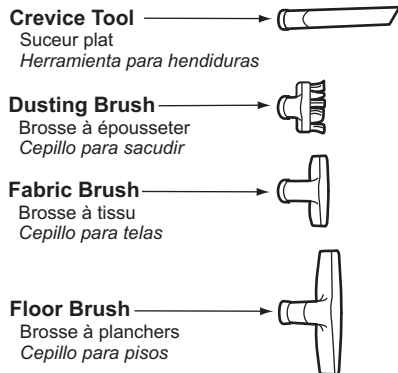

## FEATURE CHART

POWER	Overload Protector	Headlight	Tools-On-Board	Cord Length	Cord Reel
120V. AC (60Hz) 12.0 A	Yes	Yes	Yes	28 Ft. (8.5 m)	Yes

## Tableau des caractéristiques

Alimentation	Protecteur de surcharge	Dispositif d'éclairage	Accessoires	Longueur du cordon	Rappel du cordon
120 V c.a. (60 Hz) 12,0 A	Oui	Oui	Oui	8,5 m (28 pi)	Oui

## *Diagrama de características*

<i>Voltaje</i>	<i>Protector contra subrecargas</i>	<i>Luz</i>	<i>Herramientas</i>	<i>Extensión de cordón</i>	<i>Almacenamiento del cordón</i>
<i>120V. AC (60Hz) 12,0 A</i>	<i>Si</i>	<i>Si</i>	<i>Si</i>	<i>8,5 m (28 pi)</i>	<i>Si</i>

## ASSEMBLY

### Wands

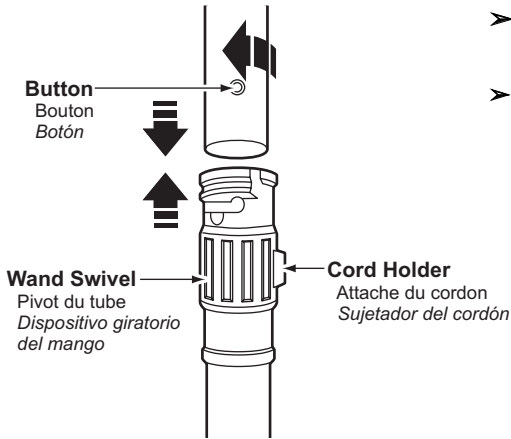

- Slide wands together until wand button snaps into place.
- Turn wand button to slotted area of wand swivel

### Power Nozzle

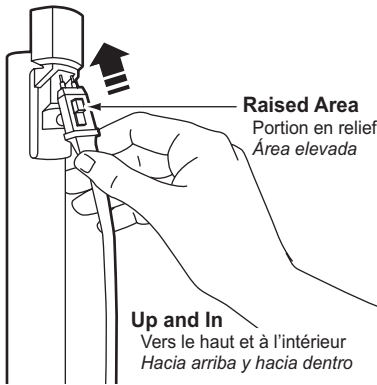

- Insert wands into **POWER NOZZLE** until the wand button snaps into the grooved slot.
- Connect **POWER NOZZLE** plug and cord as shown.
- Do not force.
- Raised area of plug must face toward hand.
- If hard to install, turn the plug over and try again.

#### To Remove:

- Press wand release button
- Pull wands out of **POWER NOZZLE**.

## Canister

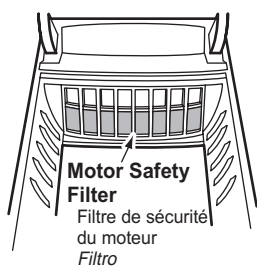

- Open canister hood
- Check dust bag (See CHANGING DUST BAG for instructions)
- Check filter (See MOTOR SAFETY FILTER CLEANING for instructions)

## Hood

- It is normal for the canister hood to come off when it is opened further than needed
- Line up the hinges, insert them, and close the hood to replace it

## Hose

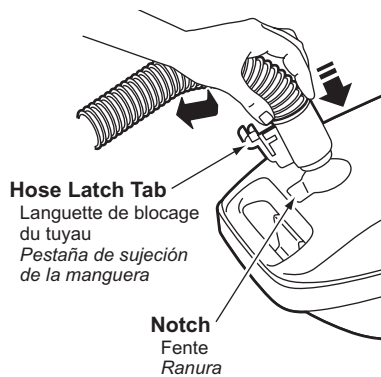

- Line up the hose latch tab and notch in canister hood and insert hose into canister until it snaps in place.

### To Remove:

- Lift hose latch tab upward and pull up on hose.
- Insert handle into wand until lock button snaps in place.
- Be sure the hose is not twisted.

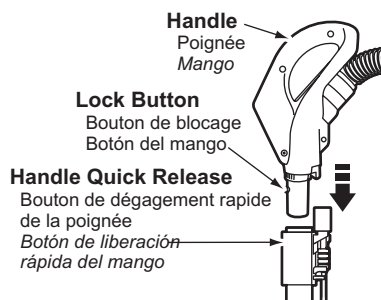

### To Remove:

- Press handle release button and pull up on handle.

## FEATURES

### Overload Protector

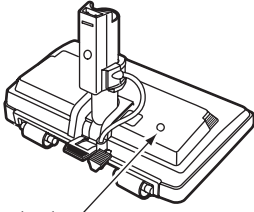

#### Overload Protector (Reset Button)

Protecteur de surcharge  
(Bouton de remise en circuit)  
Protector contra sobrecargas  
(Botón de restauración)

- The overload protector stops the **POWER NOZZLE** motor when the brush jams and prevents belt breakage.

**NOTE:** Canister motor will continue to run.

#### TO CORRECT PROBLEM:

- **Unplug electrical cord.**
- **Check brush and brush support areas for excessive lint build-up or jamming.**
- **Clean jammed area.**

#### TO RESET:

- **Press reset button on top of the **POWER NOZZLE**. Plug in and turn on cleaner.**

### Performance Indicator



- **When unit is running, lines in indicator windows will be clear if there are no clogs.**
- **When lines turn completely red there is a need to check dust bag for being full and other areas that may be clogged.**
- **See REMOVING CLOGS.**
- **Red lines may appear when using attachments or when cleaning new carpet, due to reduced airflow by attachments themselves or new carpet fuzz filling the bag quickly.**

## Suction Control

### Decrease Suction

Diminution  
de l'aspiration  
*Disminuir  
aspiración*

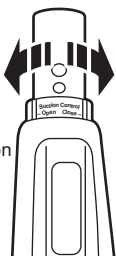

### Increase Suction

Augmentation  
de l'aspiration  
*Aumentar  
aspiración*

- Suction control allows you to change vacuum suction for different fabric and carpet weight.
- Opening control decreases suction for draperies and lightweight rugs.
- Closing control increases suction for upholstery and carpets.

## Hose Swivel

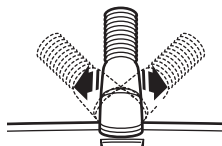

- The hose swivel allows the hose to turn without moving the canister. This is helpful for cleaning in small areas.
- Check hose for twisting before pulling canister.

## TO OPERATE CLEANER

### Power Cord

**NOTE:** To reduce the risk of electrical shock, this vacuum has a polarized plug - one blade is wider than the other. This plug will fit in a polarized outlet only one way. If the plug does not fit fully in the outlet, reverse the plug. If it still does not fit, contact a qualified electrician to install the proper outlet. **DO NOT CHANGE THE PLUG IN ANY WAY.** Only use outlets near the floor.

#### Cord Rewind Button

Bouton de rappel  
du cordon  
Almacenamiento del  
cordon eléctrico

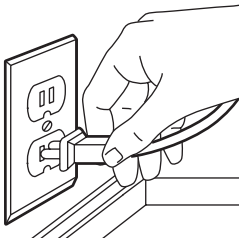
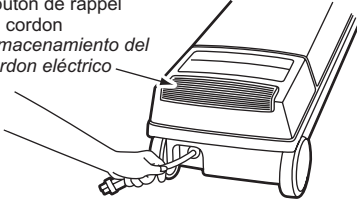

- Pull cord out of canister to desired length.
- Cord will not rewind until cord rewind button is pushed
- Plug cord into 120-volt outlet located near the floor.

#### TO REWIND:

- Unplug the cleaner.
- Hold the plug while rewinding to prevent damage or injury from the moving cord.
- Push cord rewind button.
- The cord will not rewind until the cord rewind button is pushed.

## On-Off Switch

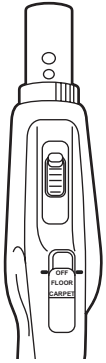

- Select a switch position on handle
- OFF
- FLOOR - turns on canister motor only
- CARPET - turns on both canister and POWER NOZZLE motors

## Handle Adjustments

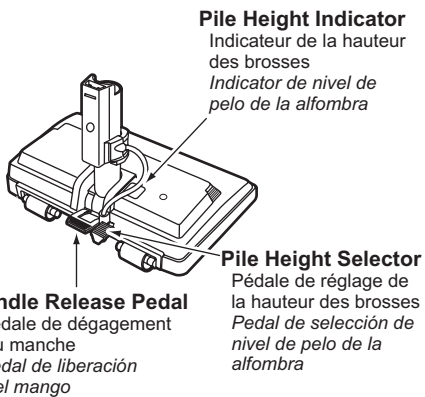

**Pile Height Indicator**  
Indicateur de la hauteur  
des brosses  
Indicator de nivel de  
pelo de la alfombra

**Pile Height Selector**  
Pédale de réglage de  
la hauteur des brosses  
Pedal de selección de  
nivel de pelo de la  
alfombra

**Handle Release Pedal**  
Pédale de dégagement  
du manche  
Pedal de liberación  
del mango

- Lower wand from upright position by pressing on the handle release pedal.
- Select a pile height setting by pressing the small pedal on the rear. The pile height setting is shown in the window.
- Return wands to upright position for storage.

## Suggested Pile Height Settings

For best deep down cleaning, use the "1" setting. However, you may need to raise the height to make some jobs easier, (such as throw rugs and some deep pile carpets) and to prevent the vacuum cleaner from shutting off. Suggested settings are: "1" - most carpets and bare floors. "2" - low to medium pile. "3" - medium to deep pile. "4" - shag; deep pile; scatter rugs.

## Using Tools



### CAUTION

**DO NOT** attach or remove handle or wands while cleaner is ON. This could cause sparking and damage the electrical contacts.

#### ATTACHMENTS ON HANDLE

- If the **POWER NOZZLE** is attached, turn cleaner off before removing handle from wands.
- Press lock button, then pull to remove handle from wand.
- Slide attachments firmly on handle as needed (See page 28).

#### ATTACHMENTS ON WANDS

- If the **POWER NOZZLE** is attached, turn cleaner off before removing plug from wands.
- To remove wands from **POWER NOZZLE**, lock wands in upright position.
- Remove **POWER NOZZLE** plug and cord from holders.
- Unplug the cord. Steady **POWER NOZZLE** with foot and turn wand counter-clockwise until lock button disappears, then pull wands out of **POWER NOZZLE**.
- Put attachments on wands as needed (See page 28).

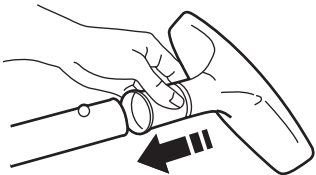
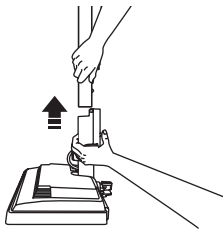
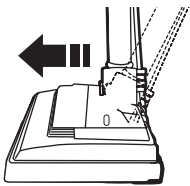
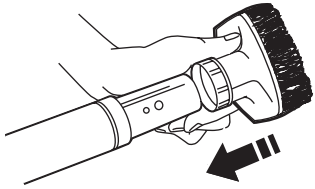
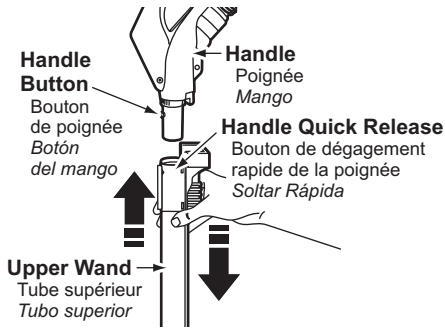

## Using Tools

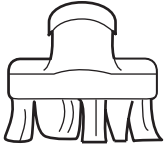

- The Dusting Brush may be used on the following items:
  - Furniture
  - Drapes
  - Stairs
  - Walls

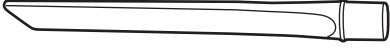

- The Crevice Tool may be used on the following items:
  - Furniture
  - Cushions
  - Drapes
  - Stairs
  - Walls

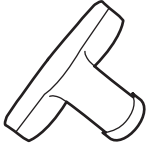

- The Fabric Brush may be used on the following items:
  - Furniture
  - Drapes

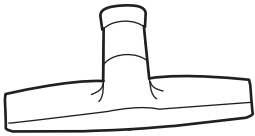

- The Floor Brush may be used on the following items:
  - Stairs
  - Bare Floors
  - Walls

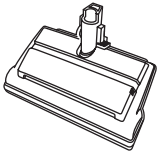

- The Power Nozzle may be used on the following items:
  - Carpeted Floors
  - Rugs

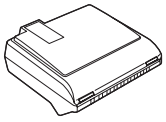

- The Compact Power Nozzle may be used on the following items:
  - Furniture
  - Stairs

**Note:** Always clean tools before using

**NOTE:** When separating wands, depress lock button completely before pulling wands apart. If wand lock button is difficult to depress, push the two wands more tightly together to line up the lock button with the hole. Depress lock button and then pull wands apart.

## Vacuuming Tips



### Suggested sweeping pattern

For best cleaning action, the **POWER NOZZLE** should be pushed straight away from you and pulled straight back. At the end of each pull stroke, the direction of the **POWER NOZZLE** should be changed to point into the next section to be cleaned. This pattern should be continued across the rug with slow, gliding motions.

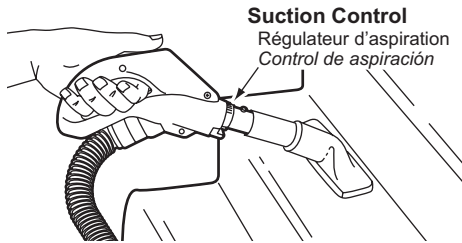

- **Fast, jerky motions do not provide complete cleaning.**
- **Small areas can be cleaned without moving the canister.**
- **Carpeted stairs need to be vacuumed regularly.**
- **For best cleaning results, fully close the suction control.**

## ROUTINE CARE OF CLEANER

### Changing Dust Bag

Always operate vacuum with genuine Panasonic micron dust bag type C-5 installed. Panasonic dust bags may be purchased through any authorized Panasonic dealer or ordered from service company.

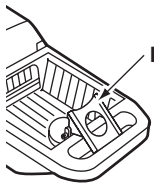
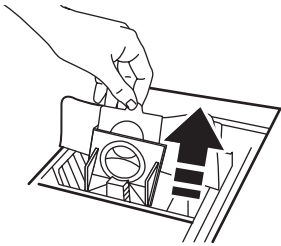
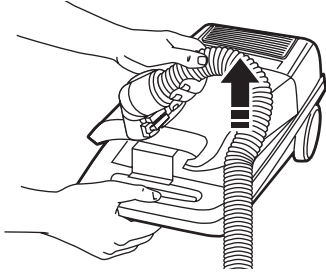

**Red Bag Mount**  
Monture rouge du sac  
Bolsa del montaje rojo

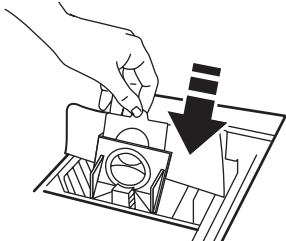

- Unplug cord from wall outlet.
- Pull hood release out and up, then lift canister hood.
- Remove cardboard tab from red bag mount by pressing away and lifting up.
- Pull bag out of the red bag mount.
- The red bag mount will flip forward after removing bag. This will prevent the lid from closing until a new bag is installed.
- Raise red bag mount up.

**Note:**  
Creasing the cardboard will cause it not to lock in place and dirt may not all go into the bag (some will miss the bag and end up in the bag cavity.)

- Install bag into slots by pushing down until the cardboard tab locks into position and the holes align.
- Close and latch canister hood.
- Plug cord into wall outlet.
- **NEVER REUSE A DUST BAG.**

## Motor Safety Filter Cleaning

- Check motor safety filter occasionally and clean when dirty.



### WARNING

#### Electrical Shock Hazard

Do not operate the cleaner without the motor safety filter. Be sure the filter is dry and properly installed to prevent motor failure and/or electrical shock.

- Unplug cord from wall outlet
- Pull out filter and frame as shown
- Replace filter
- White side is mounted facing the filter frame
- Filter cannot be cleaned and should be replaced at least once a year
- Snap filter and frame into canister
- Insert bag
- **DO NOT CLEAN FILTER WITH WATER**
- **DO NOT** operate the cleaner without filter

## Cleaning Exterior and Tools

- Unplug cord from wall outlet.
- Clean exterior using a clean, soft cloth that has been dipped in a solution of mild liquid detergent and water and wrung dry.
- **DO NOT** drip water on cleaner. Wipe dry after cleaning.
- **DO NOT** clean tools in dishwasher or clothes washer.
- Wash tools in warm soapy water, rinse and air dry.
- **DO NOT** use tools if they are wet.

## POWER NOZZLE CARE

Always follow all safety precautions when cleaning and servicing the POWER NOZZLE.



### WARNING

*Electrical Shock or Personal Injury Hazard.*

*Disconnect the electrical supply before servicing or cleaning the unit. Failure to do so could result in electrical shock or personal injury from cleaner suddenly starting.*

### Replacing Headlight Bulb

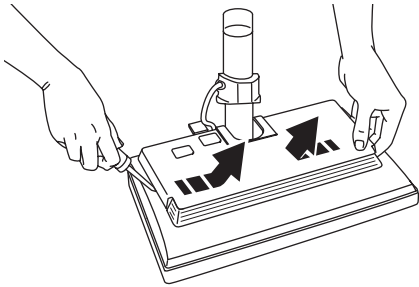

**Push in and turn**  
Enfoncer et tourner  
Empuje hacia  
adentro y gire

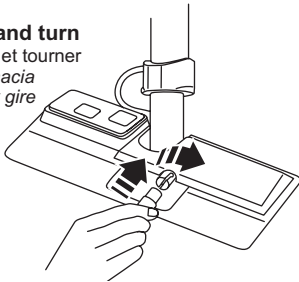

- To remove light cover use a flat blade screwdriver, gently prying one side of the light cover up.
- After freeing one side, lift up to remove.
- Push in and turn bulb counter-clockwise to remove.
- Replace the bulb.
- Only use a bulb rated 130 V AC-15 Watts.

#### To Replace:

- Fit the rear tabs into the rear of the housing and press the sides down until it snaps in place.

## Removing Belt

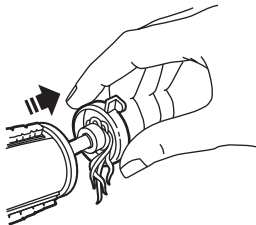
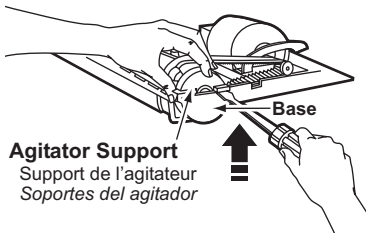
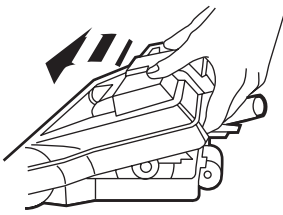
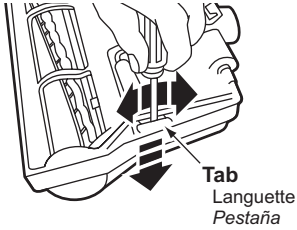
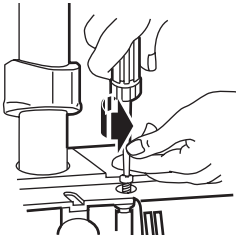

- Disconnect cleaner from electrical outlet.
- Check and remove hair, string and lint build-up frequently in the POWER NOZZLE brush and brush support areas.
- If build-up becomes excessive, disconnect POWER NOZZLE from wand and follow the steps below.
- Remove light cover and light bulb as shown under "REPLACING HEADLIGHT BULB".
- Unscrew the two (2) POWER NOZZLE cover screws.
- Turn POWER NOZZLE over.
- To remove cover, insert screwdriver at cover tabs on both sides and twist to release tabs.
- Turn POWER NOZZLE right side up.
- Press handle release pedal and lower the swivel.
- Tilt cover forward from back until front snaps free.
- Carefully insert and twist screwdriver at each brush support to free brush from base.
- Remove worn belt.
- Slide agitator supports off to check and clean agitator support areas.
- See AGITATOR ASSEMBLY for picture of complete brush assembly.

## Replacing Belt

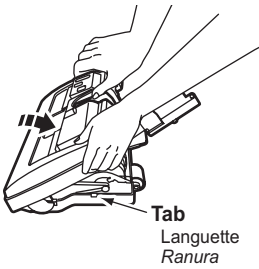
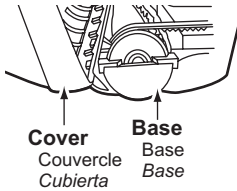
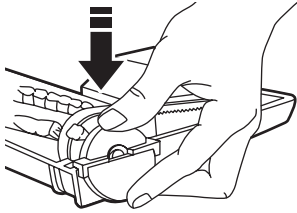
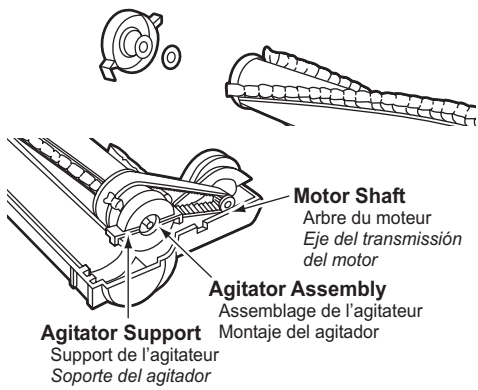

- Slide washers and agitator supports onto brush agitator unit.
- Install new belt in belt groove on the agitator assembly, then over the motor shaft.
- Be sure belt is under belt guard.
- Insert both support tabs into the base slots.
- Snap agitator supports into place.
- Line up front of cover and base.
- Rest cover on front edge of base as shown.
- Tilt cover to back.
- Press cover firmly until tabs snap into place.
- Replace cover screws, light bulb and light cover.

## Brush Servicing



### WARNING

**Electrical Shock Or Personal Injury Hazard**

Disconnect electrical supply before servicing or cleaning the unit. Failure to do so could result in electrical shock or personal injury from cleaner suddenly starting.

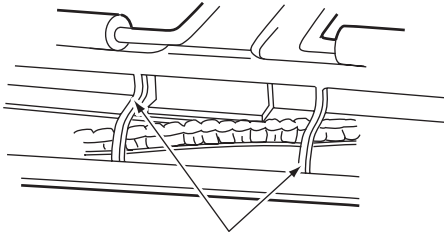

**Base Support Bars**  
Barres de support de la base  
*Barra de soporte de la base*

#### TO CHECK BRUSHES:

- When brushes are worn to the level of the base support bar, replace the brush dowel.

#### TO REPLACE BRUSH DOWEL

- Remove **POWER NOZZLE** cover, belt and agitator assembly. (See “REMOVING BELT”).
- Remove agitator supports, washers, screws, end brush, brush sprocket, and brush sprocket flange from ends of agitator assembly.
- Replace brush dowel.
- Reassemble agitator assembly.
- To line up screw holes in dowel, sprocket and end brush, be sure the brush portion of end brush lines up with brushes on brush dowel.
- Replace belt, agitator assembly and **POWER NOZZLE** cover screws. (See “REPLACING BELT”).

## Agitator Assembly

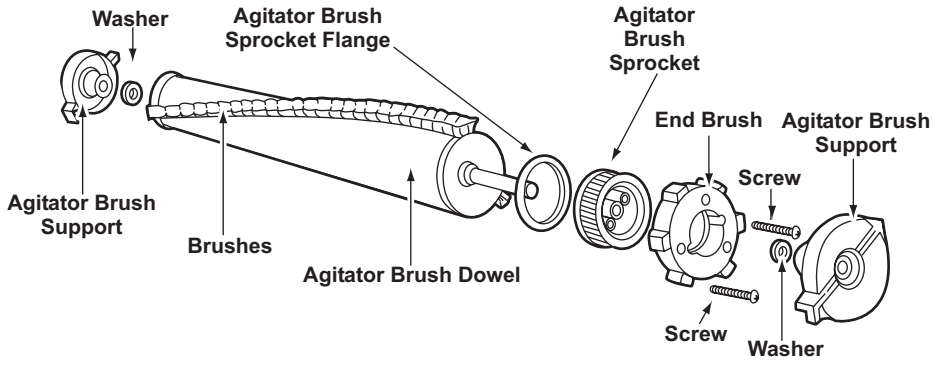

## Removing Clogs

The vacuum cleaner creates suction that picks up dirt. Rapidly moving air carries the dirt to the dust bag through the air flow passage. The dust bag lets the air pass through, while it traps the dirt.

For best cleaning results, keep the airflow passage open. Check the starred areas occasionally for clogs. Unplug unit before checking airflow.

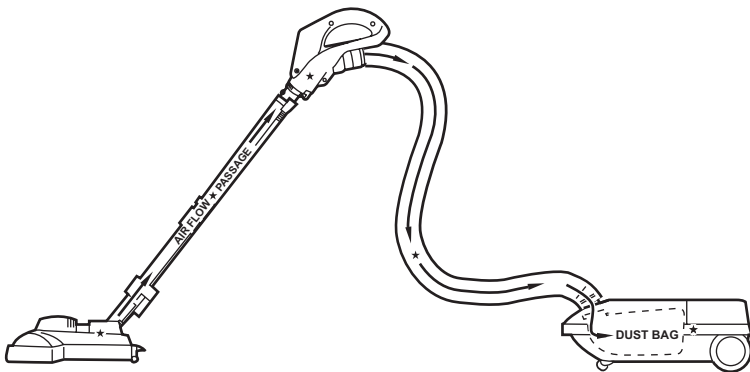

# BEFORE REQUESTING SERVICE



## **WARNING** *Electric Shock or Personal Injury Hazard.*

**Disconnect the electrical supply before servicing or cleaning the unit. Failure to do so could result in electric shock or personal injury from cleaner suddenly starting.**

Review this chart to find do-it-yourself solutions for minor performance problems. Any service needed, other than those described in these Operating Instructions, should be performed by an authorized service representative.

PROBLEM	POSSIBLE CAUSE	POSSIBLE SOLUTION
Cleaner won't start.	<ol style="list-style-type: none"> <li>1. Unplugged at wall outlet.</li> <li>2. Tripped circuit breaker/blown fuse at household service panel.</li> <li>3. Loose hose electrical connections.</li> <li>4. Tripped overload protector in POWER NOZZLE.</li> </ol>	<ol style="list-style-type: none"> <li>1. Plug in firmly, push ON/OFF switch to ON.</li> <li>2. Reset circuit breaker or replace fuse.</li> <li>3. Reconnect hose ends, (page 16).</li> <li>4. Clean brush and brush supports, then reset, (pages 18).</li> </ol>
Poor job of dirt pick-up.	<ol style="list-style-type: none"> <li>1. Full or clogged dust bag.</li> <li>2. Clogged airflow passages.</li> <li>3. Dirty safety filter.</li> <li>4. Wrong pile height setting.</li> <li>5. Open suction control.</li> <li>6. Hole in hose.</li> <li>7. Worn POWER NOZZLE brushes.</li> <li>8. Worn or broken belt.</li> <li>9. Dirty brush or brush supports.</li> <li>10. Canister hood open.</li> </ol>	<ol style="list-style-type: none"> <li>1. Change bag, (page 32).</li> <li>2. Clear airflow passages, (page 44).</li> <li>3. Replace filter, (page 34).</li> <li>4. Adjust setting, (page 24).</li> <li>5. Adjust control, (page 20).</li> <li>6. Replace hose.</li> <li>7. Replace brush, (page 42).</li> <li>8 &amp; 9. See REMOVING BELT and REPLACING BELT, (pages 38,40).</li> <li>10. Close and latch hood.</li> </ol>
Cleaner starts but cuts off.	<ol style="list-style-type: none"> <li>1. Hose or hood electrical connections.</li> <li>2. Tripped overload protector in POWER NOZZLE.</li> <li>3. Tripped overload protector in canister.</li> </ol>	<ol style="list-style-type: none"> <li>1. Check connections, reconnect hose ends, (page 16).</li> <li>2. Remove any items that may be caught or jammed, then reset. If cleaner starts and stops again, clean brush and brush supports, then reset, (pages 18).</li> <li>3. Change dust bag, clear airflow blockage, (page 32, 44). Wait 50 minutes for motor to cool and automatically reset.</li> </ol>
Power Nozzle will not run when attached.	<ol style="list-style-type: none"> <li>1. POWER NOZZLE connections unplugged.</li> <li>2. Worn or broken belt.</li> <li>3. Dirty brush or brush supports.</li> <li>4. Tripped overload protector in POWER NOZZLE.</li> </ol>	<ol style="list-style-type: none"> <li>1. Plug in firmly, (page 14).</li> <li>2 &amp; 3. See REMOVING BELT and REPLACING BELT, (pages 38, 40).</li> <li>4. Check brush area for excessive lint build-up or jamming. Clean brush and brush supports, then reset, (pages 18).</li> </ol>
Performance indicator, some models, is red.	<ol style="list-style-type: none"> <li>1. Full or clogged dust bag.</li> <li>2. Dirty filter.</li> <li>3. Clogged airflow passage.</li> <li>4. Certain attachment tools.</li> </ol>	<ol style="list-style-type: none"> <li>1. Change bag, (page 32).</li> <li>2. Replace filter, (page 34).</li> <li>3. Clear clog from airflow passage, (page 44).</li> <li>4. This is normal. Light should go off when tool is removed.</li> </ol>
Cleaner picks up moveable rugs -or- Power Nozzle pushes too hard.	<ol style="list-style-type: none"> <li>1. Wrong pile height setting.</li> <li>2. Suction too strong.</li> </ol>	<ol style="list-style-type: none"> <li>1. Adjust setting, (page 24).</li> <li>2. Open suction control, (page 20).</li> </ol>
Light won't work.	<ol style="list-style-type: none"> <li>1. Burned out light bulb.</li> </ol>	<ol style="list-style-type: none"> <li>1. Change light bulb, (page 36).</li> </ol>
Cord won't rewind.	<ol style="list-style-type: none"> <li>1. Dirty power cord.</li> <li>2. Cord jammed.</li> </ol>	<ol style="list-style-type: none"> <li>1. Clean the power cord.</li> <li>2. Pull out cord and rewind.</li> </ol>
Cleaner leaves marks on carpet.	<ol style="list-style-type: none"> <li>1. Wrong vacuuming pattern.</li> </ol>	<ol style="list-style-type: none"> <li>1. See VACUUMING TIPS, (page 30).</li> </ol>

# WARRANTY

## Panasonic Platinum Series Vacuum Cleaner Limited Warranty

Panasonic Consumer Electronics Company (collectively referred to as "the warrantor") will repair this product with new or refurbished parts free of charge, in the U.S.A. or Puerto Rico for two (2) years from the date of original purchase in the event of a defect in materials or workmanship.

**This Limited Warranty Excludes both Labor and Parts for the following items which require normal replacement:** Disposable Dust Bag, Filters, Belts, Light Bulbs, Agitator Brushes and Batteries (if supplied).

Carry-in or mail-in service in the U.S.A. can be obtained during the warranty period by contacting a Panasonic Services Company (PASC) Factory Servicenter listed in the Servicenter Directory. Or call, toll free, 1-800-211-PANA (7262) to locate a PASC Authorized Servicenter. Carry-in or mail-in service in Puerto Rico can be obtained during the warranty period by calling the local Panasonic Sales Company telephone number listed in the Servicenter Directory.

This warranty is extended only to the original purchaser. A purchase receipt or other proof of date of original purchase will be required before warranty performance is rendered.

This warranty only covers failures due to defects in materials and workmanship which occur during normal use and does not cover damages which occur in shipment, or failures which are caused by products not supplied by the warrantor, or failures which result from accident, misuse, abuse, neglect, mishandling, misapplication, faulty installation, improper operation or maintenance, alteration, modification, power line surge, improper voltage supply, lightning damage, commercial use such as hotel, office, restaurant or other business or rental use of the product, or service by anyone other than a PASC Authorized Servicenter, or damage that is attributable to acts of God.

### **LIMITS AND EXCLUSIONS:**

There are no express warranties except as listed above.  
THE WARRANTOR SHALL NOT BE LIABLE FOR INCIDENTAL OR CONSEQUENTIAL DAMAGES RESULTING FROM THE USE OF THIS PRODUCT, OR ARISING OUT OF ANY BREACH OF THIS WARRANTY. ALL EXPRESS AND IMPLIED WARRANTIES, INCLUDING THE WARRANTIES OF MERCHANTABILITY AND FITNESS FOR A PARTICULAR PURPOSE, ARE LIMITED TO THE APPLICABLE WARRANTY PERIOD SET FORTH ABOVE.

Some states do not allow the exclusion or limitation of incidental or consequential damages, or limitations on how long an implied warranty lasts, so the above exclusions or limitations may not apply to you.

This warranty gives you specific legal rights and you may also have other rights which vary from state to state. If a problem with this product develops during or after the warranty period, you may contact your dealer or Servicenter. If the problem is not handled to your satisfaction, then write to the Consumer Affairs Department at the listed address on the back cover.

# WARRANTY

Panasonic Canada Inc.  
5770 Ambler Drive, Mississauga, Ontario L4W 2T3

## Panasonic Platinum Series Vacuum Cleaner Limited Warranty

Panasonic Canada Inc. warrants this product to be free from defects in material and workmanship and agrees to remedy any such defect for a period as stated below from the date of original purchase.

**Vacuum Cleaner - Two (2) year, parts and labour**

### **LIMITATIONS AND EXCLUSIONS**

This warranty does not apply to products purchased outside Canada or to any product which has been improperly installed, subjected to usage for which the product was not designed, misused or abused, damaged during shipping, or which has been altered or repaired in any way that affects the reliability or detracts from the performance, nor does it cover any product which is used commercially. Parts such as disposable dust bags, filters, belts, light bulbs and agitator brushes are also excluded from coverage under this warranty.

This warranty is extended to the original end user purchaser only. A purchase receipt or other proof of date of original purchase is required before warranty service is performed.

**THIS EXPRESS, LIMITED WARRANTY IS IN LIEU OF ALL OTHER WARRANTIES, EXPRESS OR IMPLIED, EXCLUDING ANY IMPLIED WARRANTIES OF MERCHANTABILITY OR FITNESS FOR A PARTICULAR PURPOSE. IN NO EVENT WILL PANASONIC CANADA INC. BE LIABLE FOR ANY SPECIAL, INDIRECT OR CONSEQUENTIAL DAMAGES.**

In certain instances, some jurisdictions do not allow the exclusion or limitation of incidental or consequential damages, or the exclusion of implied warranties, so the above limitations and exclusions may not be applicable.

### **WARRANTY SERVICE**

**For product operation and information assistance**, please contact your Dealer or our Customer Care Centre at:

Telephone #: (905) 624-5505                      Fax #: (905) 238-2360                      Web: [www.panasonic.ca](http://www.panasonic.ca)

**For product repairs**, please contact one of the following:

- Your Dealer who will inform you of an authorized Servicentre nearest you.
- Our Customer Care Centre at (905) 624-5505 or [www.panasonic.ca](http://www.panasonic.ca)
- A Panasonic Factory Servicentre listed below:

<u>Richmond, British Columbia</u>	<u>Calgary, Alberta</u>	<u>Mississauga, Ontario</u>	<u>Lachine, Québec</u>
Panasonic Canada Inc. 12111 Riverside Way Richmond, BC V6W 1K8 Tel: (604) 278-4211 Fax: (604) 278-5627	Panasonic Canada Inc. 6835-8th St. N.E. Calgary, AB T2E 7H7 Tel: (403) 295-3955 Fax: (403) 274-5493	Panasonic Canada Inc. 5770 Ambler Dr. Mississauga, ON L4W 2T3 Tel: (905) 624-8447 Fax: (905) 238-2418	Panasonic Canada Inc. 3075, rue Louis A. Amos Lachine, QC H8T 1C4 Tel: (514) 633-8684 Fax: (514) 633-8020

### **IF YOU SHIP THE PRODUCT TO A SERVICENTRE**

Carefully pack and send prepaid, adequately insured and preferably in the original carton.  
Include details of the defect claimed, and proof of date of original purchase.

## WHAT TO DO WHEN SERVICE IS NEEDED (U.S.)

If your Panasonic Vacuum Cleaner needs service, look in the yellow pages of the telephone book under HOME APPLIANCE SERVICE for your nearest Panasonic Services Company ("PASC") Factory Servicenter, or PASC authorized Servicenter, or call, 1-800-211-PANA (7262) toll free to find a convenient servicenter. **DO NOT send the product to the Executive or Regional Sales offices. They are NOT equipped to make repairs.**

If you ship the product

Carefully pack and send it prepaid, adequately insured and preferably in the original carton. Attach a postage-paid letter to the outside of the carton, which contains a description of your complaint. **DO NOT send the product to the Executive or Regional Sales Offices. They are NOT equipped to make repairs.**

PANASONIC CONSUMER ELECTRONICS COMPANY  
DIVISION OF MATSUSHITA ELECTRIC CORPORATION OF AMERICA

One Panasonic Way  
Secaucus, New Jersey 07094  
World Wide Web Address  
<http://www.panasonic.com>

## What to do when service is needed Service après-vente (Canada)

### WARRANTY SERVICE

For product operation and information assistance, please contact your Dealer or our Customer Care Centre at:

Telephone #: (905) 624-5505

Fax #: (905) 238-2360

Web: [www.panasonic.ca](http://www.panasonic.ca)

For product repairs, please contact one of the following:

- Your Dealer who will inform you of an authorized Servicentre nearest you.
- Our Customer Care Centre at (905) 624-5505 or [www.panasonic.ca](http://www.panasonic.ca)
- A Panasonic Factory Servicentre listed on warranty page.

### RÉPARATION SOUS GARANTIE

*Pour de l'aide sur le fonctionnement de l'appareil ou pour toute demande d'information, veuillez contacter votre détaillant ou notre service à la clientèle au :*

*N° de téléphone : (905) 624-5505 N° de télécopieur : (905) 238-2360 Site Internet : [www.panasonic.ca](http://www.panasonic.ca)*

*Pour la réparation des appareils, veuillez consulter :*

- votre détaillant, lequel pourra vous renseigner sur le centre de service agréé le plus près de votre domicile ;
- notre service à la clientèle au (905) 624-5505 ou [www.panasonic.ca](http://www.panasonic.ca) ;
- un de nos centres de service.

## Quando necesita servicio (E.U.)

*Si su aspiradora Panasonic necesita servicio, busque el Centro de Servicio Panasonic o un Centro de Servicio PASC autorizado más cercano bajo "Servicio de Electrodomésticos" en las páginas amarillas de la guía de teléfonos o llame gratis al 1-800-211-PANA (7262) para encontrar un centro de servicio conveniente. No mande el producto a las Executive o Regional Sales Offices. No están equipadas para arreglar estos productos.*

*Si manda el producto*

*Empaquete con cuidado en el cartón original si posible y mándelo prepagado y con seguro suficiente. Ponga una carta con sellos en la que describe su problema con el producto en el exterior del cartón. No mande el producto a las Executive o Regional Sales Offices. No están equipadas para arreglar estos productos.*

PANAMEX COMPANY  
DIVISION OF MATSUSHITA ELECTRIC CORPORATION OF AMERICA

One Panasonic Way  
Secaucus, New Jersey 07094  
World Wide Web Address  
<http://www.panasonic.com>

AC01ZBMWZ000  
C01ZBMW30U00

Printed in U.S.A.  
Imprimé aux États-Unis  
**Impreso en E.U.A.**