

This Owner's Manual is provided and hosted by [Appliance Factory Parts](#).

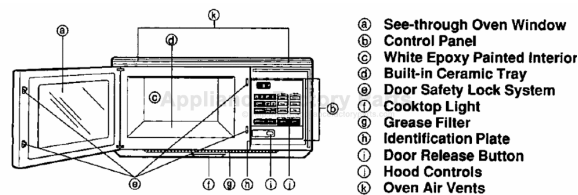

PANASONIC NN-2401 Owner's Manual

[Shop genuine replacement parts for PANASONIC
NN-2401](#)



[Find Your PANASONIC Microwave Parts - Select From 742 Models](#)

----- Manual continues below -----



Panasonic®

**Cookbook and
Operating Instructions**

Microwave Oven

**Model NN-2401/NN-2451
NN-2501/NN-2551**

Before operating this oven, please read these instructions completely.

PRECAUTIONS TO AVOID POSSIBLE EXPOSURE TO EXCESSIVE MICROWAVE ENERGY

- (a) Do not attempt to operate this oven with the door open since open-door operation can result in harmful exposure to microwave energy. It is important not to defeat or tamper with the safety interlocks.
- (b) Do not place any object between the oven front face and the door, or allow soil or cleaner residue to accumulate on sealing surfaces.
- (c) Do not operate the oven if it is damaged. It is particularly important that the oven door close properly and that there is no damage to the:
 - (1) door (bent)
 - (2) hinges and latches (broken or loosened)
 - (3) door seals and sealing surfaces
- (d) The oven should not be adjusted or repaired by anyone except properly qualified service personnel.

CONTENTS

Operating Instructions

Safety Instructions	3
Installation and Grounding Instructions	4
Safety Precautions	5
Control Panel	6
Controls and Operation Procedure	7
Time Cooking/Time Defrost	8
Auto Defrost	8
Auto Reheat	9
Frozen Foods	9
Snack Menu	10
Timer/Stand	11
Auto Start	11
The Exhaust Feature	12
Care of Your Microwave Oven	13
Questions and Answers	31
Technical Specifications	32

Cooking Guide

Food Characteristics/Cooking Techniques	14
Cookware and Utensil Guide	15
Auto Defrost	16
Time Defrost	17
Frozen Convenience Foods	18
Appetizers	19
Eggs and Cheese	20
Fish and Seafood	21
Meats	22
Pasta, Rice and Cereal Chart	23
Pies	24
Poultry	25
Quick Breads and Cakes	27
Vegetables	29
Microwave Shortcuts	30

The serial number of this product may be found on the right side of the oven door opening. You should note the model number and the serial number of this oven in the space provided and retain this book as a permanent record of your purchase for future reference.

Model No. _____

Serial No. _____

Date of Purchase _____

IMPORTANT SAFETY INSTRUCTIONS —

When using electrical appliances, basic safety precautions should be followed, including the following:

WARNING — To reduce the risk of burns, electric shock, fire, injury to persons or exposure to excessive microwave energy:

1. Read all instructions before using the appliance.
2. Read and follow the specific "**PRECAUTIONS TO AVOID POSSIBLE EXPOSURE TO EXCESSIVE MICROWAVE ENERGY,**" found on page 2.
3. This appliance must be grounded. Connect only to properly grounded outlet. See "**GROUNDING INSTRUCTIONS**" found on page 4.
4. Install or locate this appliance only in accordance with the provided installation instructions.
5. Some products such as whole eggs and sealed containers—for example, closed glass jars—may explode and should not be heated in this oven.
6. Use this appliance only for its intended use as described in this manual. Do not use corrosive chemicals or vapors in this appliance. This type of oven is specifically designed to heat or cook food. It is not designed for industrial or laboratory use.
7. As with any appliance, close supervision is necessary when used by children.
8. Do not operate this appliance if it has a damaged cord or plug, if it is not working properly, or if it has been damaged or dropped.
9. This appliance should be serviced only by qualified service personnel. Contact the nearest authorized service facility for examination, repair or adjustment.
10. Do not cover or block any openings on this appliance.
11. Do not store this appliance outdoors.
Do not use this product near water — for example, near a kitchen sink, in a wet basement, or near a swimming pool, etc.
12. Do not immerse cord or plug in water.
13. Keep cord away from heated surfaces.
14. Do not let cord hang over edge of table or counter.
15. When cleaning surfaces of door and oven that come together on closing the door, use only mild, non-abrasive soaps or detergents applied with a sponge or soft cloth.
16. To reduce the risk of fire in the oven cavity:
 - (a) Do not overcook food. Carefully attend appliance if paper, plastic, or other combustible materials are placed inside the oven to facilitate cooking.
 - (b) Remove wire twist-ties from bags before placing bag in oven.

- (c) If materials inside the oven should ignite, keep oven door closed, press the STOP/RESET Pad, and disconnect the power cord, or shut off power at the fuse or circuit breaker panel.
 - (d) Do not use the cavity for storage purposes. Do not leave paper products, cooking utensils, or food in the cavity when not in use.
17. Suitable for use above both gas and electric cooking equipment.
To reduce the risk of fire and electric shock, install at least 13 5/8 inches above a cooktop.
 18. Clean Ventilating Hoods Frequently — Grease should not be allowed to accumulate on hood or filter.
 19. Use care when cleaning the venthood filter.
Corrosive cleaning agents, such as lye-based oven cleaners, may damage the filter.
 20. When flaming foods under the hood, turn the fan off. The fan, if operating, may spread the flame. (for more information refer to page 5, under "The Hood".)

General Use

1. **Do NOT** tamper with or make any adjustments or repairs to door, control panel housing, safety interlock switches or any other part of the oven.
Do NOT remove outer panel from oven. Repairs should only be done by a qualified service person.
2. **Do NOT** operate the oven empty. The microwave energy will reflect continuously throughout the oven if no food or water is present to absorb energy.
3. **Do NOT** dry clothes, newspapers or other materials in oven. They may catch fire.
4. **Do NOT** use recycled paper products, as they may contain impurities which may cause sparks and/or fires when used.
5. **Do NOT** use newspapers or paper bags for cooking.
6. **Do NOT** hit or strike control panel. Damage to controls may occur.
7. **POT HOLDERS** may be needed when cooking. Heat is transferred from the hot food to the cooking container and from the cooking container to the oven floor. The oven floor can be very hot after removing cooking container from oven.
8. **Do NOT** operate range top burners without a pan covering them. The excessive heat may cause damage to the microwave oven.
9. When using **BOTH** the range and the microwave oven at the same time, take caution not to burn yourself when leaning over the range to reach into the microwave oven.
10. **Do NOT** store flammable materials next to, on top of, or in the oven. They could be a fire hazard.

SAVE THESE INSTRUCTIONS

For proper use of your oven read remaining safety cautions and operating instructions.

INSTALLATION AND GROUNDING INSTRUCTIONS

Examine Your Oven

Unpack oven, remove all packing material, and examine the oven for any damage such as dents, broken door latches or cracks in the door. Notify dealer immediately if oven is damaged. **Do NOT** install if oven is damaged.

Installation

1. This unit is designed for installation over a range in a standard 30" opening.
2. Be sure to install this appliance only in accordance with the installation instructions provided.
3. It is recommended that the product be mounted to a flush wall of 2" x 4" stud and 3/8" minimum thickness drywall construction. For further information, please consult the installation instructions.
4. Make sure the bottom of the top cabinet is 66" or more from the floor and 30" or more from the cooking surface.

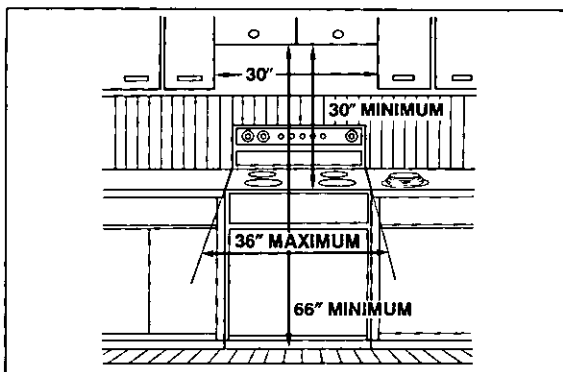

5. This oven was manufactured for household use only.

Wiring Requirements

1. The oven must be plugged into at least a 15 AMP 120 VOLT, 60 Hz GROUNDED OUTLET. Where a standard two-prong outlet is encountered, it is the personal responsibility and obligation of the consumer to have it replaced with a properly grounded three-prong outlet.

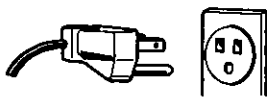

2. A TEMPORARY CONNECTION with a two-prong adaptor may be made where LOCAL CODES PERMIT it. Unless the cover screw is grounded through the house wiring, attaching the adaptor grounding plate to the cover screw will not ground the oven. If there is any doubt that the cover screw is grounded, have it checked by an electrician.



3. The oven must be on a SEPARATE CIRCUIT. No other appliance should share the circuit with the microwave oven. If it does, the branch circuit fuse may blow or the circuit breaker may trip, or the food may cook slower than times recommended in cookbook.
4. The VOLTAGE used must be the same as specified on this microwave oven (120V). Using a higher voltage is dangerous and may result in a fire or other accident causing oven damage. Using a lower voltage will cause slow cooking. Panasonic is **NOT** responsible for damage resulting from the use of the oven with other than specified voltage.

Grounding Instructions

This appliance must be grounded. In the event of an electrical short circuit, grounding reduces the risk of electric shock by providing an escape wire for the electric current. This appliance is equipped with a cord having a grounding wire with a grounding plug. The plug must be plugged into an outlet that is properly installed and grounded.

WARNING — Improper use of the grounding plug can result in a risk of electric shock.

Consult a qualified electrician or service person if the grounding instructions are not completely understood, or if doubt exists as to whether the appliance is properly grounded.

Do not use an extension cord. If the power supply cord is too short, have a qualified electrician or serviceman install an outlet near the appliance.

Radio Interference

1. Operation of the microwave oven may cause interference to your radio, TV or similar equipment.
2. When there is interference, it may be reduced or eliminated by taking the following measures:
 - a. Clean door and sealing surfaces of the oven. (See Care of Your Microwave Oven found on page 13)
 - b. Place the radio, TV, etc. away from the microwave oven as far as possible.
 - c. Use a properly installed antenna to obtain stronger signal reception.

Indoor Venting

If this appliance is to be vented inside the kitchen, a Charcoal filter kit (NNCF208) should be installed in the unit before you operate. Additional charcoal filter kits can be purchased from your local Panasonic dealer.

Follow These Safety Precautions When Cooking In Your Microwave Oven

1. **Do NOT** use your oven for home canning or the heating of any closed jar. Pressure will build up and the jar may explode. In addition, the microwave oven cannot maintain the food at the proper canning temperature. Improperly canned food may spoil and be dangerous to consume.
2. Small quantities of food or foods with low moisture content can dry out, burn or catch fire. If a fire occurs, turn oven off and leave oven door closed. Disconnect the power cord or shut off power at the fuse or circuit breaker panel.
3. Use potholders when removing utensils from the oven or when removing lids or plastic wrap covers from cooking utensils to avoid burns. Also, during microwave cooking, heat is transferred from the hot food to the cooking utensil and from the utensil to the oven floor. The oven floor can be very hot after removing the cooking utensil from the oven.
4. Popcorn must be popped in a microwave oven corn popper. Microwave corn poppers are available through many retail stores. Microwave popcorn which pops in its own package is also available. Each brand of microwave popcorn recommends that its popcorn be used in microwave ovens listed at a specific wattage. For example: "Use in a microwave oven 600 watts or greater," or "Tested in microwaves of 450 to 1000 watts." Follow popcorn manufacturer's directions and use a brand suitable for the specified wattage of your oven. See power select settings on page 7.
5. **Do NOT** attempt to deep fat fry in your microwave oven. Oil can be heated beyond ideal temperatures very quickly in a microwave oven. Temperatures can climb high enough for the cooking oils to reach their respective flash points and burst into flames. The heated oil may bubble and spatter causing possible damage to the oven and perhaps resulting in burns. Additionally, microwave-safe utensils may not be able to withstand the temperature of the hot oil, which could result in the utensil shattering if it contains even a slight imperfection, scratch or chip.
6. **Do NOT** boil eggs in their shell in a microwave oven. Pressure will build up and the eggs will explode.
7. Potatoes, apples, egg yolks, whole squash and sausages are examples of foods with nonporous skins. These types of foods must be pierced before cooking to prevent bursting.
8. Use fresh potatoes for baking, and cook until just done. The potatoes will still feel firm to the touch, but are easily pierced with a fork. Overcooking causes dehydration and may cause a fire.
9. Heated liquids can erupt if not mixed with air. **Do NOT** heat liquids in your microwave oven without first stirring.
10. Heat only 1 frozen dinner or entree in the oven at a time. If dinner or entree is heated in a foil tray, leave at least 1 inch of space between foil tray and oven walls.
11. Drying meats, herbs, fruits and vegetables is not recommended.
12. **Do NOT** use a conventional meat thermometer in the microwave oven. Arcing may occur.
13. **Do NOT** use paper towels or cloths which contain a synthetic fiber, such as nylon, woven into them. The synthetic fiber may cause the towel to ignite.
14. **Do NOT** use paper bags or recycled paper products in the microwave oven.
15. **Do NOT** use the oven for any reason other than the preparation of food.
16. **Do NOT** leave oven unattended while in use.
17. Microwave browning dishes or grills are designed for microwave cooking only. Preheating times vary depending on the size of the browning dish and food being cooked. Always follow instructions provided by the browning dish or grill manufacturer. **Do NOT** preheat browning dish more than 8 minutes.
18. If an oven cooking bag is used, prepare according to package directions. Do not use wire twist-tie to close bag. Instead, use nylon tie, a piece of cotton string or a strip cut from the open end of the bag. Make six 1/2-inch slits by closure. Place oven cooking bag in a dish slightly larger than the food being cooked.
19. When using foil, skewers, warming rack or utensils made of metal in the oven allow at least one inch of space between metal material and interior oven walls. If arcing (sparking) occurs remove metal material (skewers, etc.) and/or transfer to a non-metallic container.
20. Dishes with metallic trim should not be used, as arcing may occur.

The Hood

1. The blower fan in your oven will operate automatically under certain conditions (see Automatic Fan Feature, page 12). **Caution is required to prevent the starting and spreading of accidental cooking fires while the vent fan is in operation.**
2. Never leave surface units unattended at high heat setting. Boilover causes smoking and greasy spillovers that may ignite and spread if vent fan is operating. To minimize automatic fan operation, use adequate sized utensils and use high heat settings only when necessary.
3. In the event of a grease fire, smother flaming pan on surface unit by covering pan completely with well-fitting lid, cookie sheet or flat tray.
4. Never flame foods under the oven with the vent fan operating because it may spread the flames.
5. Keep hood and grease filters clean, according to instructions on pages 12, to maintain adequate venting and avoid grease fires.
6. To protect the automatic fan feature (see page 12) always keep the filter clean. Should the fan require repair, do not operate microwave oven until it has been repaired.
7. Charcoal filter should be replaced periodically. It may be purchased from a local Panasonic dealer.

Feature Diagram

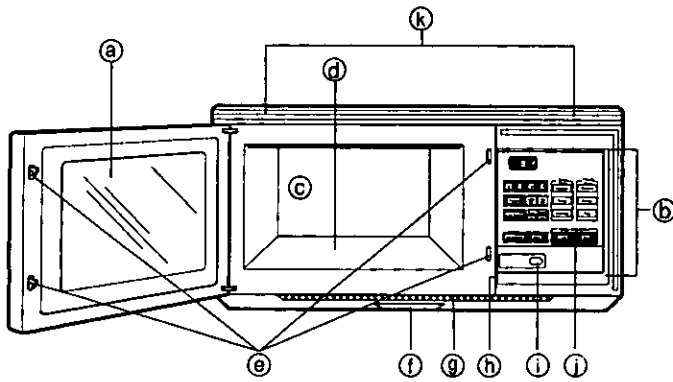

- (a) See-through Oven Window
- (b) Control Panel
- (c) White Epoxy Painted Interior
- (d) Built-in Ceramic Tray
- (e) Door Safety Lock System
- (f) Cooktop Light
- (g) Grease Filter
- (h) Identification Plate
- (i) Door Release Button
- (j) Hood Controls
- (k) Oven Air Vents

Control Panel

NN-2401/NN-2451

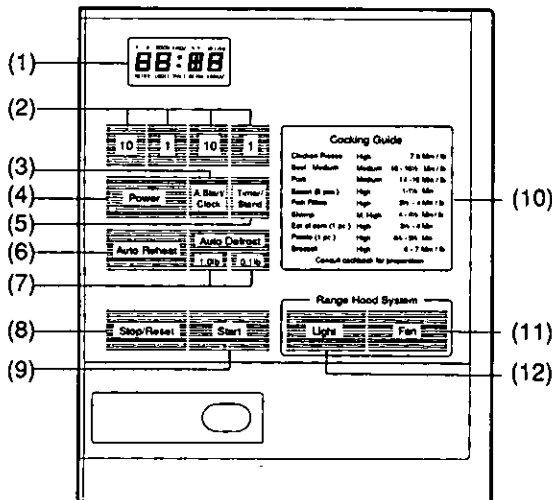

NN-2501/NN-2551

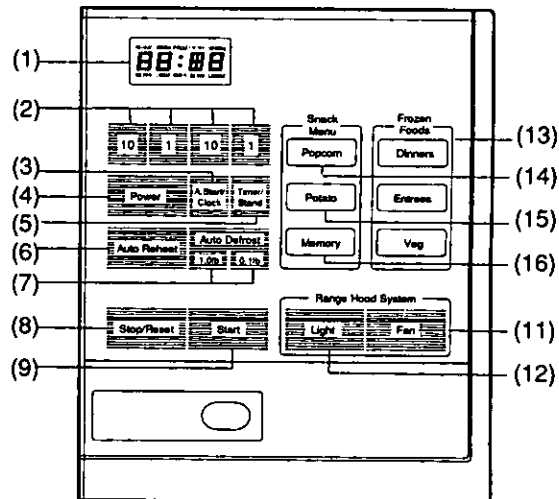

Controls with Auto Count-Up Feature*

- | | | |
|--------------------------|--------------------|-------------------------|
| (1) Display Window | (7) Auto Defrost | (12) Light Pad |
| (2) Time Pads* | 1.0 LB/0.1 LB Pad* | (13) Frozen Foods Pads* |
| (3) Auto Start/Clock Pad | (8) Stop/Reset Pad | (14) Popcorn Pad |
| (4) Power Pad* | (9) Start Pad | (15) Potato Pad* |
| (5) Timer/Stand Pad | (10) Cooking Guide | (16) Memory Pad |
| (6) Auto Reheat Pad* | (11) Fan Pad | |

Controls and Operation Procedure

TIME Pads:

The Pads serve as a 10 minute pad, 1 minute pad, 10 second pad and 1 second pad from the left, and can be programmed up to 99 minutes and 99 seconds.

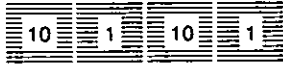

Example: To set 13 minutes 45 seconds

Press:
 10 MIN Pad: once
 1 MIN Pad: 3 times
 10 SEC Pad: 4 times
 1 SEC Pad: 5 times

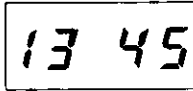

POWER Pad:

Automatically counts down HIGH to LOW. When cooking with a power other than HIGH, the oven must cycle to obtain the lower power levels. The oven light dims and clicking noises can be heard when the oven cycles.

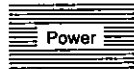

POWER LEVEL	% POWER
HIGH	100%
MEDIUM-HIGH	70%
MEDIUM	55%
DEFROST	30%
MEDIUM-LOW	30%
LOW	10%

START Pad:

One tap allows oven to begin functioning. If door is opened or STOP/RESET Pad is pressed once during oven operation, START Pad must again be pressed to restart oven.



STOP/RESET Pad:

Before cooking: One tap clears your instruction.
During cooking: One tap temporarily stops the cooking process. Another tap cancels all your instructions and time of day appears in display window.



FAN Pad:

Press to turn on exhaust fan. Press once for high and twice for low speed. Press again to turn off.



To Set Clock:

When oven is first plugged in, "88:88" will appear in the display window.

Step 1. Press A.START/CLOCK Pad.

▶ Colon will blink.



Step 2. Enter time of day by pressing appropriate TIME Pads.

▶ Time appears in display window; colon is blinking.

Example: To set 11:25

Press TIME Pads from left to right as follows:

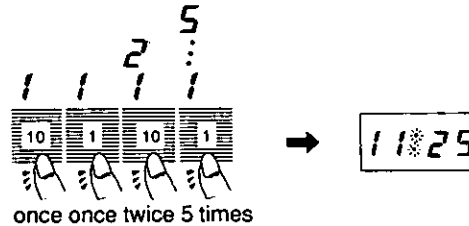

once once twice 5 times

Step 3. Press A.START/CLOCK Pad.

▶ Colon stops blinking; time of day is entered and locked into display.



NOTES ON CLOCK:

- To reset time of day, repeat step 1 through step 3.
- The clock will keep the time of day as long as oven is plugged in and electricity is supplied.
- To delete "88:88" indication, press STOP/RESET Pad.

COOKTOP LIGHT Pad:

Push and release for over-the-range Light.



Door Release Button:

Opening the door during cooking will stop the cooking process without canceling the program. Cooking resumes as soon as the door is closed and START Pad is pressed. The oven light will stay on or turn on whenever the door is opened.

Beep Sound:

When a pad is pressed correctly, a beep will be heard. If a pad is pressed and no beep is heard, the unit did not or cannot accept the instruction. The oven will beep twice between programmed stages. At the end of any complete program, the oven will beep 5 times.

Time Cooking/Time Defrost

This feature allows you to program the Cooking Time and Time Defrost by pressing Power Pad.

One Stage Cooking

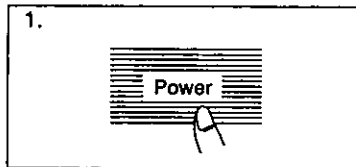

1. **Select cooking power by pressing POWER Pad.**

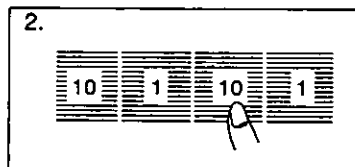

2. **Set cooking time by pressing TIME Pads.**

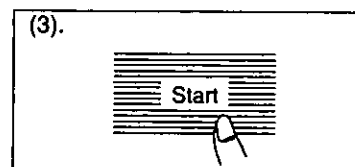

(3). **Press START Pad.**

Two Stage Cooking/Three Stage Cooking

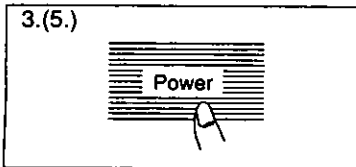

3.(5.) **Before pressing START Pad, select second cooking power by pressing POWER Pad.**

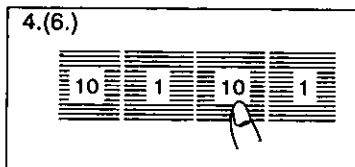

4.(6.) **Set second stage cooking time by pressing TIME Pads. (Repeat steps 3 and 4 for three stage cooking.)**

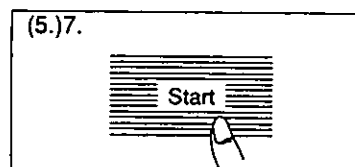

(5).7. **Press START Pad.**

NOTES ON TIME COOKING/TIME DEFROST:

1. Your oven can be programmed up to 3 stages.
2. Stand Time can be programmed before/after Time Cooking/Time Defrost.
3. When selecting HIGH power on the first stage, it is not necessary to press POWER Pad. Simply set cooking time by pressing TIME Pad and press START Pad.

Auto Defrost

This feature allows you to defrost meat, poultry and seafood by weight. Weight must be programmed in pounds and tenths of a pound.

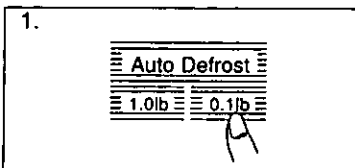

1. **Set the weight of the food by pressing 1.0 lb. Pad and/or 0.1 lb. Pad.**

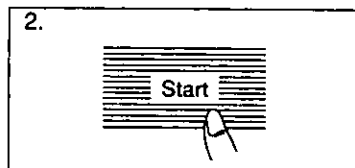

2. **Press START Pad.**

NOTES ON AUTO DEFROST:

1. To use Auto Defrost, program the weight of the food in pounds (1.0) and tenths of a pound (0.1). If a piece of meat weighs 1.95 pounds or 1 pound 14 ounces, program 1.9 pounds. If a piece of meat weighs 1.99 pounds or 2 pounds 0 ounces, program 2.0 pounds.
2. The shape and size of the food will determine the maximum weight the oven can accommodate. The recommended maximum weight of meat is 4 lbs; poultry, 6 lbs. and seafood, 3 lbs.
3. Stand time or power level may be programmed after Auto Defrost.
4. For further information on Auto Defrost, refer to page 16.

Conversion Chart

Follow this chart to convert ounces or hundredths of a pound into tenths of a pound.

Ounces	Hundredths of a Pound	Tenths of a Pound
0	.96 - .05	0.0
1 - 2	.06 - .15	0.1
3 - 4	.16 - .25	0.2
5	.26 - .35	0.3
6 - 7	.36 - .45	0.4
8	.46 - .55	0.5
9 - 10	.56 - .65	0.6
11 - 12	.66 - .75	0.7
13	.76 - .85	0.8
14 - 15	.86 - .95	0.9

Auto Reheat

This feature allows you to reheat 1 to 4 servings of precooked room temperature and refrigerator temperature foods without having to select cooking times and powers. The oven does it all automatically.

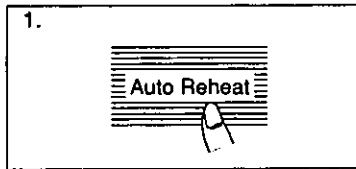

1. **Press AUTO REHEAT Pad until the desired number of servings (1-4) appears in display window.**

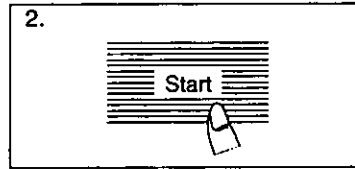

2. **Press START Pad.**

NOTES ON AUTO REHEAT:

1. Stand time or a power level can be programmed after Auto Reheat.
2. Auto Reheat can be programmed for 1 to 4 servings.
3. Listed in the box at the right are the recommended food items and approximate weights for this feature. Also listed is the starting temperature of the food item (room temperature or refrigerator temperature).

Foods	Number of Servings	Serving Size	Starting Temp.
Plate of Food	1	12 to 16 oz.	Refrig.
Meat, Poultry	1 - 4	4 to 6 oz.	Refrig.
Casseroles	1 - 2	8 to 16 oz.	Refrig.
Side Dishes	1 - 4	4 to 6 oz.	Refrig. or Room Temp.
Soups, Sauces, Gravy	1 - 2	4 to 6 oz.	Refrig. or Room Temp.

For best results follow these recommendations:

1. All foods must be previously cooked.
2. Foods should always be covered loosely with lid, plastic wrap or wax paper.
3. Foods weighing less than 4 ounces and more than 16 ounces should be reheated by power and time only.
4. All foods should have a covered stand time of 3 to 5 minutes.
5. The surrounding room temperature should not be above 95°F. Inaccurate cooking may result.

DO NOT

1. Reheat bread and pastry products. Use manual power and time.
2. Cook or reheat raw or uncooked food.
3. Use reheat if oven cavity is warm.
4. Use reheat for beverages.

Frozen Foods (NN-2501/NN-2551)

This feature allows you to reheat precooked frozen foods without having to select cooking times and powers. The oven does it automatically.

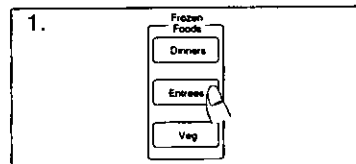

1. **Press Frozen Foods category pad. (Dinners, Entrees, or Veg) The desired weight appears in display window.**

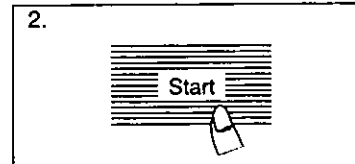

2. **Press START Pad.**

NOTES ON FROZEN FOODS:

1. Stand time or a power level can be programmed after Frozen Foods selection.
2. Follow manufacturer's directions for covering the foods or removing covers.
3. Select correct category and correct weight of food being reheated.
4. For best results, do not use frozen foods packaged in foil trays.
5. The following are the recommended weights for each category:

Dinners:	11 oz. and 15 oz.
Entrees:	7 oz., 10 oz. and 20 oz.
Vegetables:	10 oz. and 20 oz.

Snack Menu (NN-2501/NN-2551)

Popcorn Pad:

The Snack menu includes a popcorn setting for quick and easy popping of prepackaged room temperature microwave popcorn (3.5 oz.).

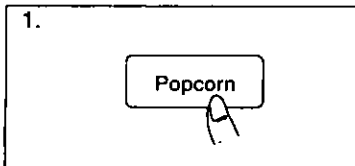

●Press **POPCORN** Pad.

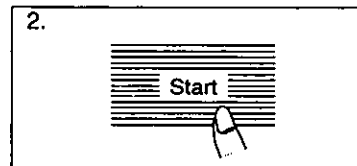

●Press **START** Pad.

NOTES ON POPCORN PAD:

1. Recommended weight of **prepackaged microwave popcorn** is 3.5 oz.
2. Place bag in oven according to manufacturer's directions.
3. Pop only one bag at a time.
4. After popping, open bag carefully, popcorn and steam are extremely hot.
5. Do not reheat unpopped kernels or reuse bag.

Potato Pad:

The Snack menu Pad also includes a potato setting which allows you to cook 1 to 4 potatoes without having to select cooking times and power levels. The oven does it automatically.

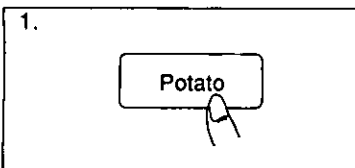

●Press **POTATO** Pad until the desired number of potatoes (1-4) appears in display window.

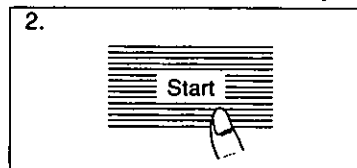

●Press **START** Pad.

NOTES ON POTATO PAD:

1. The following are the number of potatoes and recommended weights for each serving.
2. Potatoes must be pierced several times before cooking. Use only fresh potatoes.
3. Place on a microwave-safe dish in oven.
4. Let stand 5 minutes before serving.

Number of Potatoes	Approx. Weight
1 potato	6-8 oz.
2 potatoes	12-16 oz.
3 potatoes	18-24 oz.
4 potatoes	24-32 oz.

Memory Pad:

This feature allows you to conveniently program one recipe program into memory.

To set Memory Program:

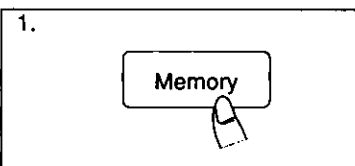

●Press **MEMORY** Pad.

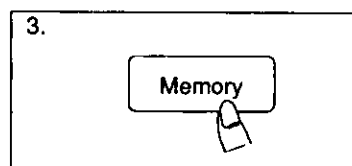
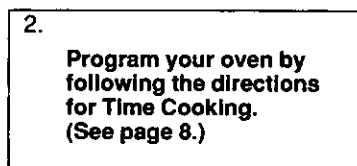

●Press **MEMORY** Pad.
If you press **START** Pad, cooking will start and cooking program is set.

To Start Memory Program:

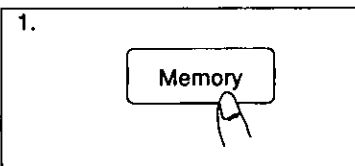

●Press **MEMORY** Pad.

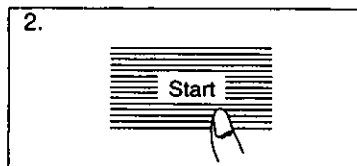

●Press **START** Pad.

NOTES ON MEMORY PAD:

1. Auto Control Functions cannot be programmed into memory.
2. Memory Pad can be programmed one or two stages.
3. Your program will be cancelled if power supply is off or plug gets disconnected.

Timer/Stand

This feature allows you to program a Stand Time after cooking is completed and to program the oven as a minute timer and/or to program delay start.

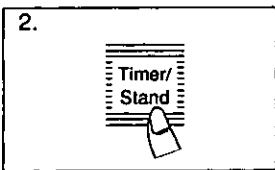
- 1. Program your oven by following the directions for Time Cooking. (See page 8.)**
- 

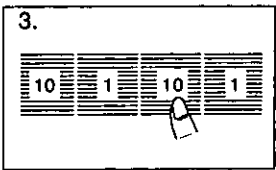
•Press **TIMER/STAND** Pad.
- 

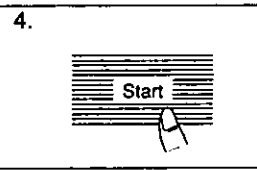
•Set desired amount of time by pressing **TIME** Pads.
- 

•Press **START** Pad.

NOTES ON TIMER/STAND:

1. This pad can also be utilized as a minute timer if you start from step 2 as shown above.
2. If oven door is opened during the Stand Time or Minute Timer, the time in display window will continue to count down.
3. To program delay start, follow steps 2 and 3 then follow step 1 to **START** Pad.

Auto Start

This feature allows you to program the time of day you want cooking to start.

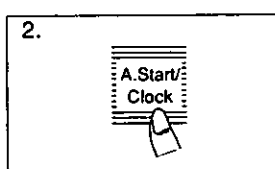
- 1. Program your oven by following the directions for Time Cooking. (See page 8.)**
- 

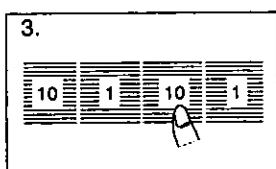
•Press **A.START/CLOCK** Pad.
- 

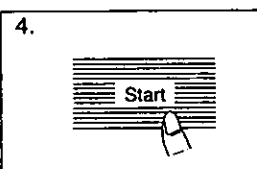
•Set the time of day you want the oven to begin cooking by pressing **TIME** Pads.
- 

•Press **START** Pad.

NOTES ON AUTO START:

1. With the Auto Start feature, the oven may be programmed up to 11 hours and 59 minutes before cooking starts.
2. To recall selected start time before cooking, press **A.START/CLOCK** Pad. Start time will appear in display window while your finger is pressing the pad.
3. One or two stage cooking can be programmed after Auto Start.
4. Auto Start cannot be programmed before any Auto Control Function. This is to prevent the starting temperature of the food from rising before defrosting or cooking begins. A change in the starting temperature could cause inaccurate results.
5. Auto Start cannot be programmed unless clock is set.

The Exhaust Feature

Automatic Fan Feature

Cooking appliances installed under the oven might, under some heavy usage conditions, cause temperatures high enough to overheat some internal parts of the microwave oven. To prevent overheating from taking place, the blower fan is

designed to automatically turn on at high speed if excessive temperatures occur. Should this happen, the fan cannot be manually turned off, but will automatically turn off when the internal parts have cooled. The blower fan may stay on up to approximately 30 minutes after the range and microwave oven controls have been turned off.

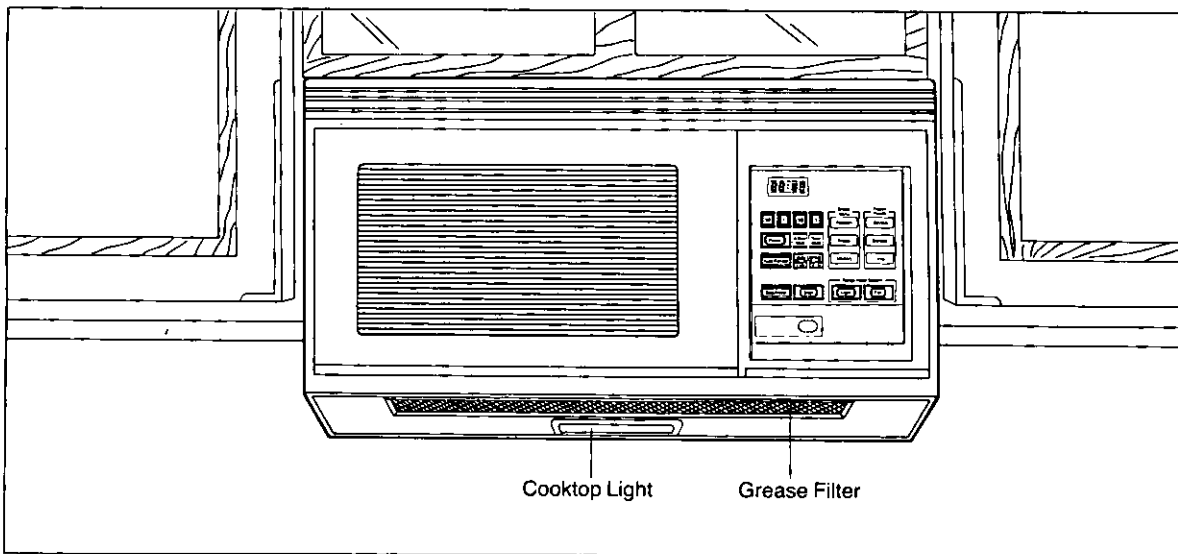

The exhaust hood feature on your Panasonic microwave oven is equipped with a metal filter which collects grease as air is drawn up through the filter.

The hood also has a cooktop light for illuminating the range surface.

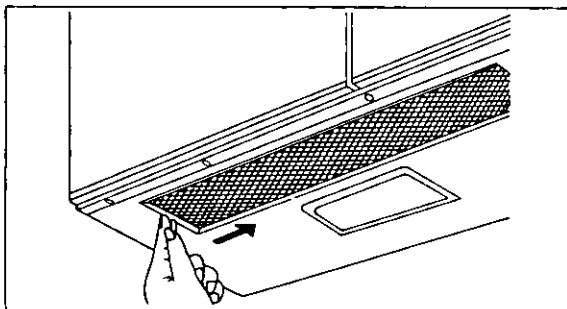

To remove grease filter, grasp the "knob" on the filter and slide filter to the right. The filter will drop out.

To replace grease filter, insert the right edge of the filter in the right side of the opening and slide it to the left.

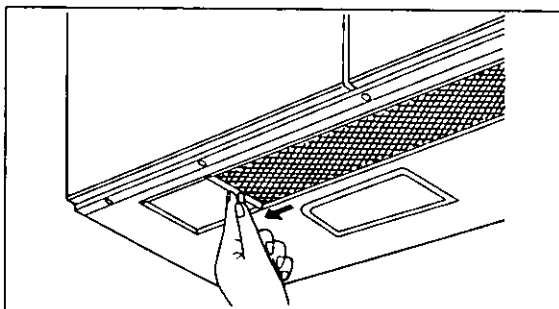

Clean the filter with a warm detergent solution. Do NOT use ammonia or other alkali because it will darken metal. Light brushing can be used to remove embedded dirt. Rinse, shake and remove moisture before replacing.

Filters should be cleaned at least once a month. Never operate the blower fan without the filter in place.

In situations where flaming might occur on surfaces below hood, filter may retard entry of flames into the appliance.

CARE OF YOUR MICROWAVE OVEN

1. Turn the oven off before cleaning.
2. Keep the inside of the oven clean. When food spatters or spilled liquids adhere to oven walls, wipe with a damp cloth. Mild detergent may be used if the oven gets very dirty. The use of harsh detergent or abrasives is not recommended.
3. The outside oven surfaces should be cleaned with a damp cloth. To prevent damage to the operating parts inside the oven, water should not be allowed to seep into the ventilation openings.
4. If the Control Panel becomes wet, clean with a soft, dry cloth. Do not use harsh detergents or abrasives on Control Panel.
When cleaning the Control Panel, leave oven door open to prevent oven from accidentally turning on. After cleaning, press STOP/RESET Pad to clear display window.
5. If steam accumulates inside or around the outside of the oven door, wipe with a soft cloth. During cooking, steam is given off from the food. Most of the steam is removed from the oven by the air which circulates in the oven cavity. Some steam will condense on cooler surfaces, such as the oven door. This also may occur when the microwave oven is operated under high humidity conditions. This is normal.
6. Clean off the grease and dust on bottom surfaces often. Use warm detergent solution. When you clean the grease filter, do not use ammonia or other alkali because it will darken metal. Light brushing can be used to remove embedded dirt. Rinse, shake and remove moisture before replacing.

Replacement of Oven Light

When it becomes necessary to replace the oven light, you can replace it yourself. Please follow the directions below carefully.

Step 1. Turn off the oven and unplug it.

Step 2. Remove the top grill by removing its two mounting screws which hold it in place.

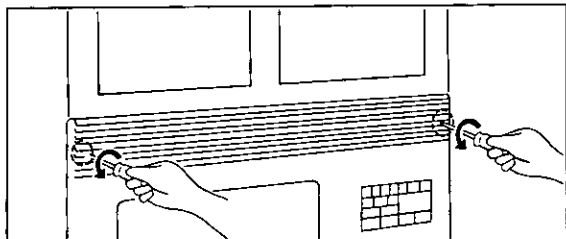

Step 3. Remove screw from the Oven Lamp Bracket.

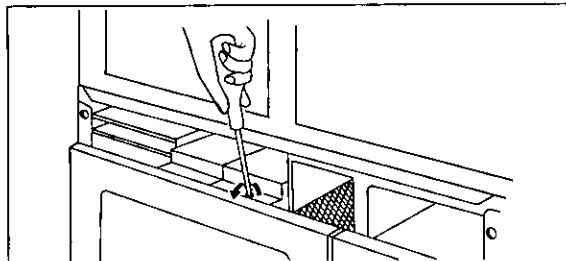

Step 4. Unscrew bulb and replace only with 115-125 V, 20 W bulb. Do not use more than 20 W bulb. If this bulb is not available locally, contact the nearest authorized Parts Distributor.
Part Number is ANE6030540AP.

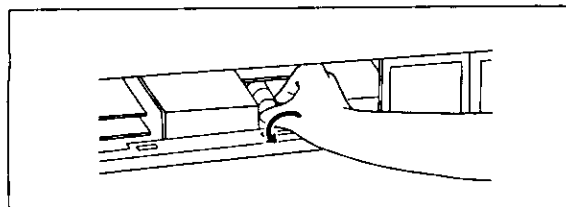

Step 5. Reinstall oven lamp bracket to its original position and secure with screw.

Replacement of Cooktop Light

Step 1. Disconnect power at main fuse or circuit breaker panel or disconnect plug.

Step 2. Remove screw from lamp cover. Make sure you hold the cover while removing the screw so cover will not drop.

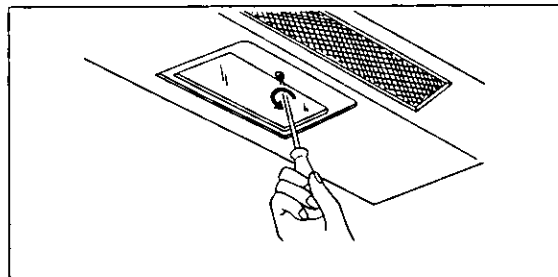

Step 3. Remove cover and replace bulb.

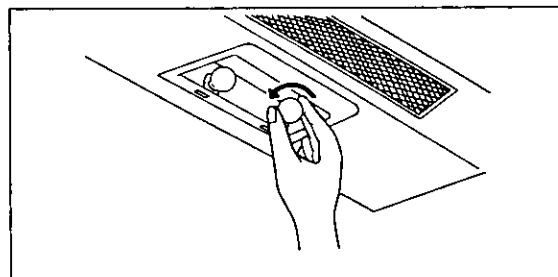

Step 4. Replace only with 115-120 V, 40 W bulb. Do not use more than 40 W bulb. If this bulb is not available locally, contact the nearest authorized Parts Distributor.
Part Number is ANE6444R20AP.

Step 5. Reinstall lamp cover. Reconnect microwave oven to electrical power.

Cooking Guide

Food Characteristics and Their Effects on Microwave Cooking

Bone and Fat: Both bone and fat affect cooking. Bones may cause irregular cooking. Meat next to the tips of bones may overcook while meat positioned under a large bone, such as a ham bone, may be undercooked. Large amounts of fat absorb microwave energy and the meat next to these areas may overcook.

Density: Porous, airy foods such as breads, cakes or rolls take less time to cook than heavy, dense foods such as potatoes and roasts.

Quantity: Two potatoes take longer to cook than one potato. As the quantity of the food increases so does the cooking time.

When cooking small amounts of food such as one or

two potatoes, do not leave oven unattended. The moisture content in the food may decrease and a fire could result.

Shape: Uniform sizes heat more evenly. The thin end of a drumstick will cook more quickly than the meaty end. To compensate for irregular shapes, place thin parts toward the center of the dish and thick pieces toward the edge.

Size: Thin pieces cook more quickly than thick pieces.

Starting Temperature: Foods that are room temperature take less time to cook than if they are refrigerator temperature or frozen.

Cooking Techniques

Spacing: Individual foods, such as baked potatoes, cupcakes and appetizers, will cook more evenly if placed in the oven equal distances apart. When possible, arrange foods in a circular pattern.

Browning: Foods will not have the same brown appearance as conventionally cooked foods. Meats and poultry may be coated with browning sauce, Worcestershire sauce, barbecue sauce or shake-on browning sauce. To use, combine browning sauce with melted butter or margarine; brush on before cooking.

Piercing: Foods with skins or membranes must be pierced, scored or have a strip of skin peeled before cooking to allow steam to escape. Pierce whole egg yolks and whites, clams, oysters, chicken livers, whole potatoes and vegetables. Whole apples or new potatoes should have a 1-inch strip of skin peeled before cooking. Score sausage and frankfurters.

Covering: As with conventional cooking, moisture evaporates during microwave cooking. Casserole lids or plastic wrap are used for a tighter seal. When using plastic wrap, vent the plastic wrap by folding back part of the plastic wrap from the edge of the dish to allow steam to escape. Loosen or remove plastic wrap as recipe directs for stand time. When removing plastic wrap covers, as well as any glass lids, be careful to remove them away from you to avoid steam burns. Various degrees of moisture retention are also obtained by using wax paper or paper towels. However, unless specified, a recipe is cooked uncovered.

Shielding: Thin areas of meat and poultry cook more quickly than meaty portions. To prevent overcooking, these thin areas can be shielded with strips of aluminum foil. Wooden toothpicks may be used to hold the foil in place.

Timing: A range in cooking time is given in each recipe. The time range compensates for the uncontrollable differences in food shapes, starting temperature and regional preferences. Always cook food for the minimum cooking time given in the recipe and check for doneness. If the food is undercooked, continue cooking. It is easier to add time to an undercooked product. Once the food is overcooked, nothing can be done.

Stirring: Stirring is usually necessary during microwave cooking. We have noted when stirring is helpful, using the words once, twice, frequently or occasionally to describe the amount of stirring necessary.

Rearranging: Rearrange small items such as chicken pieces, shrimp, hamburger patties or pork chops. Rearrange pieces from the edge to the center and pieces from the center to the edge of the dish.

Turning: It is not possible to stir some foods to redistribute the heat. At times microwave energy will concentrate in one area of a food. To help insure even cooking, these foods need to be turned. Turn over large foods, such as roasts or turkeys, halfway through cooking.

Standing Time: Most foods will continue to cook by conduction after the microwave oven is turned off. In meat cookery, the internal temperature will rise 5°F to 15°F if allowed to stand, tented with foil, for 10 to 15 minutes. Casseroles and vegetables need a shorter amount of standing time, but this standing time is necessary to allow foods to complete cooking in the center without overcooking on the edges.

Testing for Doneness: The same tests for doneness used in conventional cooking may be used for microwave cooking. Meat is done when fork-tender or splits at fibers. Chicken is done when juices are clear yellow and drumstick moves freely. Fish is done when it flakes and is opaque.

Cookware and Utensil Guide

ITEM	MICROWAVE	COMMENTS
Aluminum Foil	Yes for Shielding	Small strips of foil can be molded around thin parts of meat or poultry to prevent overcooking. Arcing can occur if foil is too close to oven wall or if too much foil is used.
Browning Dish	Yes	Check browning dish information for instructions and heating chart. Do not preheat for more than 8 minutes.
Brown paper bags	No	May cause a fire in oven.
Dinnerware Microwave-Safe, only	Yes	Check manufacturers' use and care directions for suitability for microwave heating. Some dinnerware may state on the back of the dish, "Oven-Microwave Proof."
Disposable polyester Paperboard Dishes	Yes	Some frozen foods are packaged in these dishes. Can be purchased in grocery stores.
Fast Food Carton with Metal Handle	No	May cause arcing.
Frozen Dinner Tray Metal	Yes	Frozen dinners may be heated in foil tray, if tray is less than 3/4-inch high. Place foil tray in center of oven. Leave at least 1-inch space between foil tray and oven walls. Heat only 1 foil tray in the oven at a time. For containers more than 3/4-inch deep, remove food and place in a similar size microwave-safe container.
Microwave-safe	Yes	
Glass Jars	Yes	Remove lid. Heat food until just warm. Most glass jars are not heat resistant.
Glassware Heat Resistant Oven Glassware and Ceramic, only	Yes	Ideal for microwave cooking and browning. May have many pieces available in your home.
Metal Twist Ties	No	They may cause arcing and could cause a fire in the oven.
Oven Cooking Bag	Yes	Follow manufacturers' directions. Close bag with the nylon tie provided, a strip cut from the end of the bag, or a piece of cotton string. Do not close with metal twist tie. Make six 1/2-inch slits by closure.
Paper Plates and Napkins	Yes	Use to warm cooked foods, and to cook foods that require short cooking times such as frankfurters.
Paper Towels and Napkins	Yes	Use to warm rolls and sandwiches.
Plastic Microwave-Safe, only Cookware and Storage Dishes	Yes	Should be labeled, "Suitable for microwave heating." Check manufacturers' directions for recommended uses. Some microwave-safe plastic dishes are not suitable for cooking foods with high fat content.
Plastic Wrap	Yes	Use to cover foods during cooking to retain moisture.
Straw, Wicker, Wood	Yes	Use only for short term reheating.
Plastic Foam Cups	Yes	Use to bring foods to a low serving temperature. Plastic foam will melt if foods reach a high temperature.
Thermometers Microwave-safe, only Conventional	Yes No	Use only microwave-safe meat and candy thermometers.
Wax paper	Yes	Use as a cover to prevent spattering and to retain moisture.

TO TEST A CONTAINER FOR SAFE MICROWAVE OVEN USE: Fill a 1-cup glass measure with water and place it in the microwave oven along with the container to be tested; **heat one minute at HIGH**. If the container is microwave oven-safe, it should remain comfortably cool and the water should be hot. If the container is hot, it has absorbed some microwave energy and should not be used. This test cannot be used for plastic containers.

Auto Defrost

Preparing Food for Freezing

For successful defrosting, meats should be packaged properly for freezing. Freeze meats, poultry and fish in packages with only 1 or 2 layers of food. To aid in separating layers, place two pieces of wax paper between layers. Package in heavy-duty plastic wraps, bags or freezer paper. Remove as much air as possible. Wrap should be snug against food. Seal securely and label. CONVERT ounces to tenths of a pound. Meats packaged in most grocery stores are labeled with the weight in pounds and hundredths of a pound. See conversion chart on page 8.

Remove wrapper. Otherwise, the wrap will hold steam and juice close to the food which can cause the outer surface of the food to cook.

Remove ground meat from its TRAY. Place meat in an appropriate size dish.

Place roast fat-side down and whole poultry breast-side down on a microwave roasting rack in a dish. The rack helps prevent the food from sitting in its own juice. The juice will get hot during defrosting and if the food is sitting in the juice, the bottom will begin to cook.

Place small items, such as chops, chicken pieces, shrimp, scallops, fish on a microwave roasting rack in a dish.

The oven beeps once during the defrosting cycle to signal that the food needs to be turned or rearranged. Follow the directions given in the chart for the best defrosting results. For best results, the minimum recommended weight is 0.5 pound.

FOOD	BEEP	AFTER DEFROSTING
Meat (Max.Weight: 4 lbs.) Chops or Steaks Frankfurters / Sausage Ground meat or Stew Meat Hamburger Patties Roast Ribs	Shield / Turn Over / Separate Separate / Remove Defrosted Pieces Turn Over / Remove Defrosted Pieces Separate Turn Over / Separate / Remove Defrosted Patties Turn Over / Shield Shield / Turn Over / Remove Defrosted Pieces	Stand 5 min. Stand 5 min. Stand 5 min. Stand 5 min. Stand 30 min. in refrigerator. Stand 10 min.
Poultry (Max.Weight: 6 lbs.) Split Cornish Hens Whole Cornish Hens Chicken Pieces Whole Chicken	Shield / Turn Over Shield / Turn Over Separate / Remove Defrosted Pieces Shield / Turn Over	Stand 5 min. Stand 20 min. Run cold water in cavity Stand 5 min. Stand 20 min. Run cold water in cavity.
Fish and Seafood (Max.Weight: 3 lbs.) Sea scallops Shrimp Fish Fillets	Separate / Turn Over / Remove Defrosted Pieces Turn Over / Separate Turn Over / Separate	Stand 5 min. Run under cold water. Rinse under cold water. Stand 5 min. Run under cold water.

Time Defrost

Defrosting Fish, Seafood, Meats and Poultry

Before freezing, package meats according to directions given in "Preparing Food for Freezing" on page 16.

Remove food from wrapper and set in a microwave-safe dish. Place small items, such as chops, chicken pieces, shrimp, scallops and fish on a microwave roasting rack set in a dish.

Select **DEFROST** using Power Pad and the time recommended in the chart. Large roasts may still be icy in center; allow to stand. Turn food over two to

three times during the defrost cycle. Separate chops, hamburger patties, stew meat, chicken pieces, scallops and shrimp halfway through the defrost cycle.

Remove defrosted portions from ground meat, chicken pieces, scallops and shrimp halfway through the defrost cycle. Large roasts may still be icy in center; allow to stand.

Shield thin portions with aluminum foil.

Fish and seafood should still be slightly icy.

Allow to stand to finish defrosting.

Rinse whole poultry under cold water.

FOOD	DEFROST TIME (min. per pound)	DIRECTIONS	AFTER DEFROSTING
Fish and seafood			
Crabmeat	14 to 16	Break apart halfway through defrost time.	Stand 5 minutes.
Fish fillets	8 to 12	Turn over halfway through defrost time. Rinse under cold water to separate.	Stand 5 minutes.
Fish Steaks	10 to 12	Turn over halfway through defrost time.	Stand 5 minutes.
Sea Scallops	16 to 18	Break apart halfway through defrost time. Remove defrosted scallops. Rinse under cold water.	Stand 5 minutes.
Shrimp medium	12 to 14	Break apart halfway through defrost time. Rinse under cold water.	Stand 5 minutes.
Whole fish	10 to 12	Shield tail halfway through defrost time. Rinse under cold water.	Stand 5 minutes.
Beef			
Ground Beef	10 to 12	Turn over and remove defrosted portion halfway through defrost time.	Stand 10 minutes.
Liver	12 to 14	Drain liquid as it defrosts. Separate pieces.	Stand 5 minutes.
Roasts	10 to 12	Turn over 2 to 3 times during defrost time. Shield ends.	Let stand in refrigerator 30 minutes.
Sirloin Steak	12 to 14	Turn over halfway through defrost time.	Stand 5 minutes.
Rib or T-Bone	8 to 10	Turn over halfway through defrost time.	Stand 5 minutes.
Flank	8 to 10	Turn over halfway through defrost time.	Stand 5 minutes.
Stew Meat	10 to 12	Break apart halfway through defrost time.	Stand 5 minutes.
Pork			
Bacon	6 to 8	Defrost in original wrapper. Turn over halfway through defrost time. Center should be slightly icy.	Stand 5 minutes.
Chops	12 to 14	Separate and turn over halfway through defrost time.	Stand 5 minutes.
Ribs	8 to 10	Turn over halfway through defrost time.	Stand 5 minutes.
Roasts	12 to 14	Turn over 2 to 3 times during defrost time. Shield ends.	Let stand in refrigerator 30 minutes.
Lamb			
Chops	10 to 12	Separate and turn over halfway through defrost time.	Stand 5 minutes.
Ribs	6 to 8	Turn over halfway through defrost time.	Stand 5 minutes.
Roasts	12 to 14	Turn over 2 to 3 times during defrost time.	Let stand in refrigerator 30 minutes.
Poultry			
Chicken, Whole (up to 3 lb.)	14 to 16	Turn over 2 to 3 times during defrost time. Rinse under cold water.	Let stand in refrigerator 20 minutes.
Pieces	8 to 10	Separate halfway through defrost time.	Stand 10 minutes.
Cutlets	8 to 10	Turn over halfway through defrost time. Rinse under cold water to separate.	Stand 5 minutes.
Cornish Hens	10 to 12	Turn over halfway through defrost time. Rinse under cold water.	Stand 10 minutes.
Turkey Breasts	10 to 12	Turn over 2 to 3 times during defrost time. Rinse under cold water.	Let stand in refrigerator 20 minutes.

Frozen Convenience Foods

Most frozen convenience foods have microwave heating directions on the back of the package. Refer to these directions for recommended power levels, heating times and general instructions.

General Directions for Heating Frozen Convenience Foods

Arrange small items, such as appetizers, in a circular pattern on a paper towel lined plate.

Arrange fried chicken or fried fish between 2 pieces of paper towels on a plate. Coating will not be crisp after heating.

Pierce pouch vegetables or entrees with a fork or knife. Place pouch in a dish before heating.

Frozen foods packaged in microwave-safe containers should be heated according to manufacturers' directions.

Frozen Foods in metal containers deeper than 3/4-inch must be removed from the foil container and placed in an appropriately sized microwave-safe container. Heat covered with lid or plastic wrap.

Note: If food is difficult to remove from container, rinse bottom of container with hot water.

Frozen foods in metal containers less than 3/4-inch may be heated in the container in the microwave oven.

To heat frozen dinners in foil containers, remove dinner from box. If there is a foil cover, remove it. Some foods, such as bread, French fries or batter type desserts, such as brownies, do not microwave well. Remove these types of food from tray. Cover tray except desserts with plastic wrap. Heat according to manufacturers' directions. Place foil tray in center of oven. Foil tray should not touch oven walls or other metal. Heat only 1 foil tray in the oven at a time.

Defrosting Frozen Convenience Foods

ITEM	DEFROST TIME (in minutes)	DIRECTIONS
BAKED GOODS		
Bagels or Hard Rolls (1 to 2 oz. ea.)		
2	2 1/2 to 3 1/2	Wrap in paper towel.
4	3 to 4	
Coffee Cake (11 to 12 oz.)	4 to 5	Remove from original container and place on a serving plate.
Cupcakes (10 to 11 oz.)	3 to 5	Arrange in a circular pattern in oven.
Danish		
1	1 to 2	Place on a paper or serving plate.
2	3 to 4	
4 (9 oz. pkg.)	5 to 7 1/2	
Layer Cake (17 to 18 oz.)	3 to 3 1/2	Remove from original container and place on a serving plate.
Pound Cake (10 3/4 oz.)	2 to 4	Remove from original container and place on a serving plate.
MISCELLANEOUS		
Frozen Juice Concentrates (6 oz.)	2 1/2 to 3 1/2	Remove lid. Place contents in a microwave-safe glass measure.
(12 oz.)	4 to 5	
Frozen Mixed Fruit (10 oz.)	9 to 11	Pierce pouch and place in a dish or remove metal ends and place in a dish.
Frozen Vegetables (6 oz.)	8 to 10	Remove from box. Break apart after 3 minutes. If vegetables are in a pouch, pierce pouch.
(10 oz.)	12 to 14	
Non-Dairy Creamer (16 oz.)	14 to 16	Open carton. Shake vigorously 2 times during defrost.

ORIENTAL DUMPLINGS

Filling:

- 1/2 pound cooked pork, finely chopped
- 1/2 pound shrimp, cleaned and finely chopped
- 1/4 cup finely chopped green onions
- 1 tablespoon chopped parsley
- 1 jalapeno pepper, finely chopped
- 1 teaspoon salt
- 1/2 teaspoon pepper
- 1 egg white

Wonton wrappers, (approximately 1 lb.)

Yield: Approximately 45 Dumplings

In medium bowl combine all filling ingredients. Place a teaspoon of filling mixture in center of a wonton wrapper. Wet inside edges of wrapper with small amount of water. Fold top left and bottom right corner of wrapper over filling and press together to seal. Place 11 dumplings on microwave safe rack. Heat 1 1/2 cups water in 2-cup glass measure at **HIGH** 3 minutes. Pour water into bottom of 4-quart casserole. Set rack with dumplings in casserole dish. (Rack should be high enough so water does not reach bottom of dumplings.) Brush dumplings with water. Cover with lid. Heat at **HIGH** 2 1/2 minutes. Turn dumplings over; brush with water. Recover. Heat at **HIGH** 2 1/2 minutes. Repeat with remaining dumplings. Serve with plum sauce or other dipping sauces.

HOT TORTELLINI KABOBS

- 4 ounces stick pepperoni, cut into 1/2-inch cubes
- 1/2 pound cheese filled tortellini, cooked (see page 23)
- 1/2 cup Italian dressing, divided
- 1 (6 oz.) jar marinated artichoke hearts, drained
- 1/2 cup pitted ripe olives
- 1/2 cup roasted red pepper strips
- 1/4 cup grated Parmesan cheese
- 12 wooden skewers

Yield: 12 Skewers

Toss tortellini with 2 tablespoons Italian dressing. Alternately thread pepperoni, tortellini, artichoke hearts, olives and red pepper on wooden skewers. Arrange 2 layers in 11x7-inch dish. In small bowl, combine remaining dressing and Parmesan cheese. Pour over skewers. Cover with wax paper. Cook at **HIGH** 4 to 5 minutes, or until hot. Serve immediately.

COCKTAIL MEATBALLS

- 1/2 pound ground beef
- 1 egg, beaten
- 1/2 cup Italian flavored dry bread crumbs
- 1 clove garlic, finely chopped
- 2 tablespoons finely chopped green onion
- 1/2 teaspoon salt
- 1/4 teaspoon basil leaves, crushed
- Dash pepper
- 1/2 cup grape jelly
- 1/2 cup chili sauce
- 1 tablespoon prepared mustard

Yield: 24 Meatballs

In medium bowl, combine ground beef, egg, bread crumbs, garlic, onion and seasonings. Mix lightly. Shape into 24 bite-size meatballs. In 2-quart casserole, combine jelly, chili sauce and mustard. Mix until well blended. Add meatballs. Cover with lid. Cook at **HIGH** 6 1/2 minutes and at **MEDIUM-LOW** 9 to 10 minutes. Stir twice. Stir; let stand, uncovered, 3 minutes before serving.

STUFFED MUSHROOMS

- 1 pound medium mushrooms (about 24), cleaned
- 4 slices bacon, chopped
- 1 small onion, finely chopped
- 1/2 cup dry bread crumbs
- 1/3 cup white wine or water
- 1/4 cup grated Parmesan cheese
- 1/8 teaspoon pepper

Yield: 24 Mushrooms

Remove stems from mushrooms. Finely chop enough stems to equal 1 cup; set aside. Place bacon and onion in bowl. Cook at **HIGH** 4 to 5 minutes, or until bacon is crisp and onion is tender; stir once. Drain. Stir in chopped mushroom stems, bread crumbs, wine, cheese and pepper. Stuff mushroom caps with bread crumb mixture. Arrange half of mushrooms in a circular pattern in a 9-inch microwave-safe pie plate. Cook at **HIGH** 4 1/2 to 6 1/2 minutes. Let stand, uncovered, 2 minutes before serving. Repeat procedure with remaining mushrooms.

Variation: For **SPINACH STUFFED MUSHROOMS**, partially defrost 1 package (12 oz.) frozen spinach souffle. Cut into squares and place in mushroom caps; sprinkle, if desired, with onion salt. Heat as directed above.

EGGS AND CHEESE

SCRAMBLED EGGS

Beat eggs, 1 tablespoon milk and dash salt for each egg. Pour into greased glass container. Cook at **MEDIUM** according to time in the chart. Stir two-thirds of the way through the cooking time. Stir and let stand. Eggs will continue to cook during stand time and should be slightly undercooked after cooking.

Eggs	Container	Cooking Time (in min.)	Stand Time (in min.)
1	1-cup glass measure	3/4 to 1 1/4	1
2	1-cup glass measure	1 1/2 to 2	1 1/2
4	1-quart bowl	3 1/4 to 3 3/4	1 1/2
6	1 1/2-quart bowl	4 3/4 to 5 1/2	2

POACHED EGGS

Place 1 1/2 cups hot water and a dash of vinegar and salt in 2-quart casserole and heat at **HIGH** 5 to 7 minutes, or until water boils. Break egg(s) into boiling water and with toothpick pierce egg yolk twice and egg white several times. Cook at **MEDIUM** according to the time given in the chart. Let stand. Eggs will continue to cook during stand time and should be slightly undercooked after cooking.

Eggs	Cooking Time (in min.)	Stand Time (in min.)
1	1/2 to 3/4	1
2	1 to 1 1/4	2
4	1 3/4 to 2	2

Eggs should NOT be cooked in their shells in a microwave oven. Pressure will build up and the egg will explode.

BASIC OMELET

1 tablespoon butter or margarine
2 eggs
2 tablespoons milk
1/8 teaspoon salt
Dash pepper

Yield: 1 Serving

Heat butter in 9-inch pie plate at **HIGH** 1 minute, or until melted; turn plate to coat bottom with butter. Meanwhile, combine remaining ingredients; pour into pie plate. Cook, covered with plastic wrap, at **MEDIUM-HIGH** 2 to 3 1/2 minutes, or until omelet is almost set; stir after 1 minute. Let stand, covered, 2 minutes. With spatula, loosen edges of omelet from plate; fold into thirds to serve.

Variations: Try one of these easy variations:

For CHEESE Omelet, before folding, sprinkle 1/4 cup shredded cheese down center of omelet.

For HAM Omelet, before folding, sprinkle 1/4 cup finely chopped cooked ham down center of omelet.

For HERB Omelet, blend 1/8 teaspoon basil, thyme or crushed rosemary with eggs and milk.

For JELLY Omelet, before folding, spoon 1/4 cup jelly down center of omelet.

MACARONI AND CHEESE

1 package (8 oz.) elbow macaroni, cooked and drained (see page 23)
3/4 pound pasteurized process cheese spread, cut into cubes
3/4 to 1 cup milk
1/2 to 3/4 teaspoon salt
1/4 teaspoon onion powder
1/4 teaspoon pepper
1/8 teaspoon dry mustard, optional
Buttered bread crumbs

Yield: 4 Servings

In 3-quart casserole, combine macaroni, cheese, milk, salt, onion powder, pepper and mustard. Cover with lid. Cook at **MEDIUM** 12 to 15 minutes; stir twice. Top with bread crumbs. Cook, uncovered, at **MEDIUM** 3 minutes. Let stand, covered, 10 minutes before serving.

Variation: Use 1/2 cup tomato sauce for 1/4 cup milk and 1/8 teaspoon oregano for dry mustard.

Directions for Preparing Fish and Seafood

Use fresh or defrosted clean fish.
 Arrange fish in a single layer in dish. For best results, avoid overlapping edges as this will prevent fish from cooking evenly.
 Place thicker sections toward edge of the dish. (i.e. tail sections toward center).
 Arrange shrimp and scallops in single layer in dish.
 Cook fish or seafood covered loosely, but completely with plastic wrap.

Rearrange or stir shrimp or scallops halfway through cooking.
 Test for doneness before adding extra cooking time. The color of seafood and fish should be opaque and the fish should flake easily when tested with a fork. If undercooked, return to oven and cook 15 to 30 seconds longer at recommended power level.
 Let stand, covered, 3 to 5 minutes before serving. Stand time allows the internal temperature to equalize throughout the food and thereby completes the cooking process.

Fish and Seafood Chart

FISH OR SEAFOOD	AMOUNT	POWER	APPROX. COOKING TIME (in minutes)
Fish Fillets	1 lb.	HIGH	5 to 7
Fish Steaks (1-inch thick)	1 lb.	HIGH	6 to 8
Scallops (sea)	1 lb.	MEDIUM-HIGH	6 to 8
Shrimp, medium size (shelled and cleaned)	1 lb.	MEDIUM-HIGH	4 to 5½
Whole fish, cleaned (stuffed or unstuffed)	1 to 1½ lb.	HIGH	6 to 8

SWEET AND SOUR FILLETS

1 pound flounder fillets
 ¼ cup packed brown sugar
 1 tablespoon cornstarch
 1 can (8 oz.) pineapple chunks, drained; reserve syrup
 ½ medium green pepper, cut into thin strips
 ¼ cup cider vinegar
 1 tablespoon soy sauce
 2 green onions, thinly sliced
 ⅛ teaspoon garlic powder
 ¼ cup slivered almonds, roasted (see page 30)

Yield: 4 Servings

In 9½-inch square dish, arrange fillets in single layer.
 Cover with plastic wrap. Cook at **HIGH** 5 to 7 minutes, or until fish flakes easily with fork. Let stand, covered, 5 minutes. Meanwhile in 2½-quart shallow oval casserole dish, combine sugar and cornstarch. Stir in reserved pineapple syrup. Add green pepper, vinegar, soy sauce, green onions and garlic powder. Cook at **HIGH** 3 to 4 minutes, or until mixture is thickened; stir twice. Stir in pineapple chunks and almonds. Arrange fillets on serving dish. Spoon mixture over fillets.

FILLET AMANDINE

3 tablespoons butter or margarine
 3 tablespoons slivered almonds
 ½ pound fish fillets
 Salt and pepper to taste
 Lemon juice
 Parsley

Yield: 2 Servings

Place butter and almonds in 8-inch square dish. Cook at **HIGH** 3 to 4 minutes; stir once. Dip fillets in butter on top of fish. Season with salt and pepper. Sprinkle with lemon juice. Cover with plastic wrap. Cook at **HIGH** 4 to 5 minutes, or until fish flakes when tested with a fork. Let stand, covered, 3 minutes; sprinkle with parsley before serving.

MEATS

Place meat fat-side down on microwave roasting rack set in an 8- to 10-inch square dish or 2 1/2-quart shallow oval casserole dish. Beef Rib Roast should be placed cut-side down.

For tender cuts of beef and lamb roasts, loosely cover with wax paper to prevent spatter. For pork roasts or hams, cover with plastic wrap or place in an oven cooking bag. Less tender cuts such as pot roasts can also be cooked in an oven cooking bag. Prepare bag according to manufacturer's package directions.

Do NOT use wire or metal twist-ties to close bag. Use nylon tie provided, a piece of cotton string or a strip cut from the open end of the bag. Make six 1/2-inch slits by the closure to allow steam to escape. If a large amount of juice accumulates in the bottom of the dish, drain occasionally. Multiply the weight of the roast by the minimum recommended minutes per pound. Program Power and Time. Turn meat over halfway through cooking time.

Beef, Pork and Lamb Roasts: Can be shielded at the beginning of cooking or halfway through cooking. If you wish to shield at the beginning of cooking, remove foil halfway through the cooking time. Beef and pork rib roasts should be shielded by the bones. Foil should extend about 2 inches down from bones. The shank bone on a lamb roast should be cupped with foil. Thin ends of boneless roasts should also be shielded. Foil should NOT touch oven sides since arcing may occur.

Canned Hams: Shield on the top cut-edge with a 1-inch strip of foil. Wrap strip of foil around ham and secure to body of ham with wooden toothpicks. Fold 1 inch over cut surface. Place ham in dish. Cover loosely, but completely with plastic wrap. Turn ham over and reshield, halfway through cooking. If desired, glaze during last 10 to 20 minutes of cooking.

Less tender cuts, such as pot roasts, should be cooked in liquid. Use 1 cup of liquid such as soup or broth per pound of meat. Use an oven cooking bag (see information at left regarding oven cooking bags) or covered casserole. Select a covered casserole deep enough so that the meat does not touch the lid. Multiply the weight of the roast by the minimum recommended minutes per pound. Program Power and Time. Turn meat over halfway through cooking. Meat should be fork-tender when done.

After cooking, check temperature using a meat thermometer. The thermometer should not touch bone or fat. If it does, the reading could be inaccurate. Lower temperatures are found in the center of the roast and in the muscle close to a large bone, such as a pork loin center rib roast. If the temperatures are low, return meat to the oven and cook a few more minutes at the recommended power level. **Do not use a conventional meat thermometer in the microwave oven.** Let stand, tented with foil, 10 to 15 minutes. During stand time, internal temperature rises 5°F to 15°F.

Meat Roasting Chart for Time Cooking

MEAT	POWER	APPROX. COOKING TIME (min / lb.)	TEMPERATURE AFTER COOKING	SPECIAL INSTRUCTIONS
BEEF ROASTS (up to 4 lbs.) Rib, Boneless Rib, Top Sirloin Rare Medium Well Rump, Eye of Round (High Quality) Rare Medium Well Pot Roast (2 1/2 to 3 1/2 lb.) Chuck, Rump	MEDIUM MEDIUM MEDIUM MEDIUM MEDIUM MEDIUM MEDIUM-LOW	11 to 12 1/2 14 to 15 1/2 17 to 19 9 to 11 1/2 12 to 14 15 to 17 25 to 30	130° F 140° F 160° F 130° F 140° F 160° F —	Place roast fat-side down. Turn meat over halfway through cooking time. Turn meat over halfway through cooking time.
PORK ROASTS (up to 4 lbs.) Bone-in ———— Boneless ————	MEDIUM MEDIUM	14 to 16 1/2 14 to 16 1/2	170° F 170° F	Place roast fat-side down. Turn meat over halfway through cooking time.
HAM (fully cooked) Canned (3lb.) Butt (8 lb.) Shank (8 lb.) Slice, 1-inch thick (1lb.)	MEDIUM MEDIUM MEDIUM HIGH	9 to 9 1/2 11 1/2 to 12 11 to 13 5 to 8	140° F 140° F 140° F —	Place ham fat-side down. Turn over halfway through cooking time.
LAMB ROASTS (up to 4 lbs.) Bone-In Medium Well Boneless Medium Well	MEDIUM MEDIUM MEDIUM MEDIUM MEDIUM	12 to 13 15 to 16 1/2 12 1/2 to 13 14 to 16	140° F 160° F 140° F 160° F	Place lamb fat-side down. Turn meat over halfway through cooking time.

PASTA, RICE AND CEREAL CHART

ITEM	CONTAINER	AMOUNT OF HOT WATER	POWER TO COOK	APPROX. TIME TO COOK (in min.)	STAND TIME (in min.)	SPECIAL INSTRUCTIONS
Pasta						
Egg Noodles medium width (8 oz.)	3-qt. casserole	1 1/2 quarts	HIGH	8 to 10	3	Add 1 teaspoon oil and 1 teaspoon salt to water. Cover and heat hot water to a boil at HIGH (approx. 10 to 12 min.). Stir in pasta. Cook, covered; stir occasionally. Let stand, covered. Pasta that is to be added to casserole should be slightly undercooked.
Specialty Noodle (8 oz.)	3-qt. casserole	1 1/2 quarts	HIGH	11 to 13	3	
Spaghetti or Fusilli (8 oz. broken)	3-qt. casserole	2 quarts	HIGH	17 to 19	3	
Frozen Tortellini (16 oz.)	3-qt. casserole	1 1/2 quarts	HIGH	13 to 18	3	
Rice						
Flavored Rice Mix (4.4 to 7.5 oz.)	2-qt. casserole	as package directs	MEDIUM	15 to 30 or as package directs	10	Cover and heat hot water to a boil at HIGH (approx. 8 to 10 min.). Add rice, salt and butter (amount of salt and butter as package directs). Cook covered; stir. Let stand, covered.
Long Grain (1 cup)	2-qt. casserole	2 cups	MEDIUM	13 1/2 to 15 1/2	10	
Short Grain (1 cup)	2-qt. casserole	2 cups	MEDIUM	10 to 12	10	
Cereal						
Cream of Wheat (Regular) 1 serving (2 1/2 tbsp.) 2 servings (1/2 cup)	1-qt. glass bowl	1 cup	MEDIUM-LOW	2 to 3	1	Cover and heat hot water to a boil at HIGH (approx. 3 to 4 min.). Add cereal; stir frequently. Cook uncovered. Stir once before stand time.
	1 1/2-qt. glass bowl	1 3/4 cups	MEDIUM-LOW	4 to 6	1	
Farina 1 serving (3 tbsp.) 2 servings (6 tbsp.)	1-qt. glass bowl	1 cup	MEDIUM-LOW	2 to 3	1	Cover and heat hot water to a boil at HIGH (approx. 3 to 4 min.). Slowly add cereal; stir frequently. Cook uncovered. Stir once before stand time.
	1 1/2-qt. glass bowl	2 cups	MEDIUM-LOW	4 to 5	1	
Oatmeal(Quick) 1 serving (1/3 cup) 2 servings (2/3 cup) 4 servings (1 1/3 cups)	individual serving dish	1/2 cup	HIGH	1 to 2	1	Combine hot water and cereal. Cook uncovered. Stir once before stand time.
	1-qt. glass bowl	1 1/2 cups	HIGH	3 to 4	1	
	2-qt. glass bowl	3 cups	HIGH	5 to 6	2	
Wheat Bran Cereal 1 serving (1/4 cup) 2 servings (1/2 cup) 4 servings (1 cup)	1-qt. glass bowl	3/4 cup	HIGH	3 to 4	1	Combine hot water and cereal. Cook uncovered. Stir once before stand time.
	1 1/2-qt. glass bowl	1 1/2 cups	HIGH	6 to 7 1/2	1	
	2-qt. glass bowl	3 cups	HIGH	7 to 8	2	

To prepare Instant Rice: Combine 1 cup water, 1 teaspoon butter and dash salt in 1-quart casserole. Cover with lid. Cook at HIGH 2 to 3 minutes or until water boils. Stir in 1 cup rice. Let stand, covered, 5 minutes. Fluff lightly with fork before serving.

Preparing Pie Crusts

Prepare pastry according to recipe or package directions.

If desired, for a single crust homemade pastry recipe, substitute 1/2 cup whole wheat flour for 1/2 cup all-purpose flour.

Microwave pie crusts are light in color. A few drops of yellow food coloring may be mixed with the liquid before adding liquid to the flour mixture. This will give the crust a pale yellow color.

Roll dough out and gently place in pie plate.

Trim edge so a 3/4-inch overhang remains. Roll overhang down to rim of pie plate. Flute edge.

Prick bottom and sides of pastry with fork.

Let pie crust rest 10 minutes. This rest time helps reduce shrinkage.

If desired, brush with dark corn syrup or molasses for sweet fillings, or brush with Worcestershire or soy sauce for savory fillings.

For frozen crust, thaw and remove from foil pie plate and place in an 8- or 9-inch glass pie plate. Place on an inverted pie plate. Heat 1/2 minute, then prick crust and, if desired, brush with dark corn syrup, molasses, Worcestershire or soy sauce.

For crumb crusts, combine 1/3 cup butter and 1/4 cup sugar in medium bowl. Heat at **HIGH** 1 1/2 to 2 minutes, or until butter is melted. Stir in 1 1/4 cups crumbs (graham crackers, chocolate or vanilla wafers). Firmly pat into greased 9-inch pie plate.

Cook according to directions given in chart.

Visually check for doneness. Pastry crusts should be opaque. If crust is undercooked, add cooking time in 15 second increments.

Let stand until cool. Chill crumb crusts.

PIE CRUST CHART

ITEM	POWER	APPROX. COOKING TIME (in minutes)
Homemade or Mix	HIGH	4 to 5
Refrigerated	MEDIUM-HIGH	4 to 5 1/2
Frozen	HIGH	4 to 5
Graham Cracker or Cookie Crumb	MEDIUM-HIGH	2 to 2 1/2

COCONUT LEMON MERINGUE PIE

- 1 1/2 cups sugar
- 1/3 cup cornstarch
- 1/4 teaspoon salt
- 1 1/2 cups boiling water
- 3 eggs, separated
- 1/2 cup lemon juice
- 3 tablespoons butter or margarine
- Grated peel of 1 lemon
- 9-inch pie shell, baked (see chart this page)
- 1/3 cup sugar
- 1/4 cup coconut

Yield: 8 Servings

In 3-quart casserole, combine 1 cup sugar, cornstarch and salt; stir in boiling water. Cover with lid. Cook at **HIGH** 8 to 10 minutes, or until thickened; stir twice. Stir in small amount of hot mixture into egg yolks; return to hot mixture, beating until well blended. Add lemon juice, butter and lemon peel. Pour into pie shell and chill until set. Meanwhile, beat egg whites until soft peaks form; gradually add remaining sugar and beat until stiff. Spread meringue over filling, making sure it touches crust all around. Sprinkle with coconut. Cook at **HIGH** 4 to 6 minutes, or until meringue is set. Cool completely.

CHOCOLATE ROCKY ROAD PIE

- 1 package (3 5/8 oz.) chocolate pudding and pie filling mix
- 1 3/4 cups milk
- 1 to 1 1/2 cups miniature marshmallows
- 1/2 to 1 cup coarsely chopped walnuts
- 9-inch chocolate cookie crumb crust, baked (see chart this page)

Yield: 8 Servings

Combine pudding mix and milk in 4-cup glass measure. Cook at **MEDIUM-HIGH** 6 to 8 minutes, or until pudding is thickened; stir until smooth. Cool 5 minutes; fold in marshmallows and nuts. Turn into prepared crust; chill until firm. Garnish, if desired, with toasted coconut or chopped nuts.

Directions for Roasting Poultry

Season as desired, but salt after cooking. Browning sauce mixed with equal parts of butter will enhance appearance.

Poultry may be stuffed or unstuffed. Tie legs together with cotton string. Place **breast-side down** on microwave roasting rack set in 8-to 10-inch square dish or 2 1/2-quart shallow oval casserole dish. Cover with wax paper to prevent spatter. Turn breast-side up, except chicken parts, after half the cooking time. Re-cover with wax paper.

If a large amount of juice accumulates in the bottom of the baking dish, occasionally drain it. If desired, reserve for making gravy.

During cooking it may be necessary to shield legs, wings and the breast bone to prevent overcooking. Wooden toothpicks can be used to hold foil in place.

Less tender hens should be cooked in liquid such as soup or broth. Use 1/4 cup per pound of poultry. Use an oven cooking bag or covered casserole. Select a covered casserole deep enough so that hen does not touch the lid.

If an oven cooking bag is used, prepare according to package directions. **Do NOT use wire twist-ties to close bag.** Do use nylon tie, a piece of cotton string or a strip cut from the open end of the bag. Make six 1/2-inch slits by the closure to allow steam to escape.

Multiply the weight of the poultry by the minimum recommended minutes per pound. Program Power and Time.

After cooking, check the temperature of large chickens and turkeys with a meat thermometer. Check the temperature in both thigh muscles. If the thermometer touches bone, the reading may be inaccurate.

Do NOT use a conventional thermometer in the oven when cooking by microwave.

Small chickens and game birds are cooked when juices run clear and drumsticks readily move up and down. If poultry is undercooked, cook a few more minutes at the recommended power level. Let large chickens and turkeys stand, tented with foil, 10 to 15 minutes before carving.

To Cook Chicken Parts: Arrange pieces skin-side up, with meatier portions toward edge of dish. Cover with wax paper. Multiply the weight by minutes per pound recommended in chart below. Cook at **HIGH**. Poultry is cooked when juices are clear. If there is a slight pink color in the juice, return poultry parts to the oven and cook one or two minutes longer. Let stand, covered, 5 minutes before serving.

POULTRY	POWER	COOKING TIME (minutes per pound)	TEMPERATURE AFTER COOKING
Cornish Hens, whole (1 to 1 1/2 lb. ea.)	HIGH	8 to 10	_____
Chicken parts	HIGH	7 to 8	_____
Chickens (up to 4 lb.)	HIGH	8 to 10	_____
Chickens (4 to 6 lb.)	MEDIUM-HIGH	14 to 16	180°F to 190°F
Turkey Breast (5 to 6 lb.)	MEDIUM	15 to 17	180°F to 190°F
Duck (3 to 5 lb.)	MEDIUM-HIGH	8 to 10	180°F to 190°F

FIESTA CHICKEN ROLL-UPS

2 boneless chicken breasts, skinned, split and pounded thin (about 1 to 1¹/₄ lb.)

Chili powder

Pepper

2 ounces Cheddar cheese, cut into quarters

1/4 cup sliced green olives

1/4 cup butter or margarine, melted

3/4 cup crushed taco or corn chips

1 can (8 oz.) taco or seasoned tomato sauce

Yield: 4 Servings

Season one side of each chicken breast with chili powder and pepper. Place one stick of cheese on each breast. Sprinkle 1 tablespoon of olives down center. Fold edges over to enclose filling. Secure with wooden toothpicks.

Carefully roll in melted butter, then crushed corn chips. Arrange seam-side down in 8-inch square dish. Cover with wax paper. Cook at **HIGH** 8 to 9 minutes, or until chicken is tender. Let stand, covered, 5 minutes. Meanwhile, in small glass bowl, cook taco sauce at **HIGH** 2 to 3 minutes, or until hot. Serve over chicken.

ORIENTAL CHICKEN AND CASHEWS

3 tablespoons oil

2 boneless chicken breasts, skinned and thinly sliced (about 1 to 1¹/₄ lb.)

2 cloves garlic, finely chopped

2 tablespoons soy sauce

1 tablespoon sherry

1 tablespoon cornstarch

1/4 teaspoon ginger

1 medium green pepper, cut into small chunks

1/2 cup cashew halves or chopped walnuts

Yield: 4 Servings

Heat oil in 3-quart casserole at **HIGH** 2¹/₂ to 3 minutes. Meanwhile, combine chicken, garlic, soy sauce, sherry, cornstarch and ginger. Add to dish and cook at **HIGH** 4 to 5 minutes; stir twice. Add green pepper and cashews. Cover with plastic wrap. Cook at **HIGH** 3 to 5 minutes, or until chicken and green pepper are tender; stir once. Let stand, covered, 3 minutes before serving.

HONEY GLAZED CHICKEN

1/4 cup honey

2 tablespoons orange juice

1 tablespoon chili sauce

1 teaspoon prepared mustard

1 teaspoon browning sauce, optional

2 chicken breasts, (1³/₄ to 2 lb.) split

Yield: 4 Servings

Combine honey, orange juice, chili sauce, mustard and browning sauce; stir. Arrange chicken breasts in 12 x 8-inch dish with meatier portions toward edge of dish. Pour honey mixture over chicken.

Cover with wax paper. Cook at **HIGH** 7 to 8 minutes and at **MEDIUM** 8 to 9 minutes; or until chicken is done. Let stand, uncovered, 5 minutes before serving.

STUFFED CORNISH HENS WITH ORANGE SAUCE

2¹/₂ cups hot water

1 can (6 oz.) frozen orange juice concentrate, defrosted and divided (see page 18)

1 package (6 oz.) long grain and wild rice mix

4 slices bacon, cooked and crumbled

4 Cornish hens (1 lb. ea.)

1/4 cup honey

1/4 to 1/2 teaspoon browning sauce

Yield: 4 Servings

In 2-quart casserole, combine water, 1/4 cup orange juice concentrate and rice. Cover with lid. Cook at **HIGH** 8 minutes and at **MEDIUM** 20 minutes, or until rice is tender; stir in bacon. Stuff hens with rice mixture; with cotton string, tie legs together. Place hens in 12 x 8-inch dish. Cover with wax paper. Cook at **HIGH** 28 to 32 minutes, or until hens are tender. Meanwhile, combine remaining orange juice concentrate, honey and browning sauce; brush hens every 10 minutes. Let stand, covered, 10 minutes before serving.

QUICK BREADS AND CAKES

Directions for Quick Breads and Cakes

Layer cakes must be baked one layer at a time, or the entire cake mix may be baked in a 16-cup fluted tube dish. Prepare batter according to package, chart or recipe directions. Use dishes recommended in chart or in recipes. Glass dishes allow the bottom of the cakes to be checked for doneness. When the product is removed from the oven, visually check bottom. If cake is to be inverted or removed from dish, such as layer cakes or upside-down cake, grease sides of dish and line bottom of 8- or 9-inch round or square dish with wax paper. If cake is to be served directly from the dish, grease bottom of dish. Never flour cake dishes, fluted tube dishes or muffin pans. Use only 2¹/₄ cups of batter for an 8- or 9-inch round or square dish. Cover with wax paper. Elevate on inverted pie plate when stated in recipe. Cook second layer immediately after the first. The remaining batter can be used for cupcakes.

When using fluted tube dish, be sure to grease sides and "tube." All the batter from a 2-layer cake mix may be poured into a 16-cup fluted dish.

When cooking cupcakes or muffins, line microwave muffin pans with paper baking cups. Fill paper baking cups half full. Cover with wax paper when indicated in chart or recipe.

Check during cooking. Different brands vary in ingredients and density of batter; cooking times may be slightly different than those given in chart.

After cooking, test for doneness. Check to make sure edges of cake are dry and have begun to pull away from sides of dish, and toothpick inserted near center comes out clean.

Let stand, uncovered, on a flat surface for 10 to 15 minutes. Stand time is important to allow cakes and cupcakes to finish baking.

Cakes and breads that are to be inverted should be loosened from the sides of the dish. Carefully turn out of dish. Remove wax paper from bottom of cake. Store, covered, until ready to serve.

Frost, if desired, when completely cooled.

Microwave cakes are very tender and may tear if too much pressure is applied when they are frosted.

ITEM	AMOUNT OF BATTER	PREPARATION/DISH SIZE	FIRST STAGE	SECOND STAGE	SPECIAL INSTRUCTIONS	STAND TIME
Quick Bread (15.4 to 17 oz.)	All batter	Line bottom of 8 ¹ / ₂ × 4 ¹ / ₂ × 2 ¹ / ₂ -inch loaf dish with wax paper	MEDIUM-LOW 8 minutes	HIGH 5 to 6 minutes	Shield each end with a 3-inch strip of foil. Mold foil around handle. Remove shields after 1st stage of cooking.	15 minutes, uncovered.
Cornbread (8 or 10 oz.)	All batter	Grease 8- or 9-inch round or square dish	MEDIUM-HIGH 6 to 7 minutes	————	Cover with wax paper.	10 minutes, uncovered.
Gingerbread (14 oz.)	All batter	8-inch square dish	MEDIUM-HIGH 7 to 8 minutes	————	————	15 minutes, uncovered.
Muffins (Cook 6 at a time)	Fill 1/2 full	6-cup muffin pan lined with paper baking cups	MEDIUM 4 to 5 minutes	————	————	5 minutes, uncovered.
Cake Mix (18 to 20 ¹ / ₄ ounces)	2 ¹ / ₄ cups	Wax paper-lined 8- to 9-inch round or square glass baking dish	MEDIUM-LOW 6 minutes	HIGH 1 to 2 minutes	Place dish on microwave-safe inverted pie plate during baking. Cover with sheet of wax paper.	10 minutes, uncovered.
Cake Mix (18 to 20 ¹ / ₄ ounces)	Prepare batter according to package directions. Pour all batter into pan.	Grease 16-cup fluted tube pan	MEDIUM 14 to 15 minutes	————	Cover pan with wax paper.	15 minutes, uncovered.
Cupcakes	2 rounded tablespoons batter per cupcake. Fill paper baking cups half full.	Muffin pan lined with paper baking cups 1 2 4 6	MEDIUM (in minutes) 3/4 to 1 1 to 1 ¹ / ₄ 1 ¹ / ₂ to 2 3 to 3 ¹ / ₂	————	Cover with wax paper during baking.	5 minutes, uncovered.

QUICK BREADS AND CAKES

SOUR CREAM COFFEE CAKE

1/2 cup sugar
1/4 cup butter
1 1/2 cups flour
1 cup sour cream
2 eggs
1 1/2 teaspoons vanilla
1 teaspoon baking powder
1 teaspoon baking soda
1/2 teaspoon salt

Topping:

1/3 cup chopped walnuts
1/4 cup sugar
1/2 teaspoon cinnamon

Yield: 8 Servings

In large bowl, with electric mixer, cream, sugar and butter. Add remaining ingredients. Beat at low speed 30 seconds and at medium speed 2 minutes. Pour into greased 8-inch square dish. In small bowl, combine topping ingredients; sprinkle over batter. Cover with wax paper. Cook at **MEDIUM** 6 minutes and at **HIGH** 5 to 6 minutes, or until edges are dry and toothpick inserted near center comes out clean. Let stand, uncovered, 10 minutes. Serve immediately.

CARROT SPICE CAKE

1 1/4 cups flour
1 cup packed brown sugar
1 teaspoon baking powder
1 teaspoon baking soda
2 teaspoons cinnamon
1/2 teaspoon allspice
1/2 teaspoon salt
1 1/4 cups shredded carrot
2/3 cup oil
2 eggs
1 can (8 oz.) crushed pineapple, drained
1 teaspoon vanilla
1/4 cup chopped nuts
1/2 cup raisins

Yield: 8 Servings

In a large bowl with electric mixer, combine flour, sugar, baking powder, baking soda, cinnamon, allspice, salt and carrot. Stir in oil, eggs, pineapple and vanilla and beat 2 minutes at medium speed. Stir in nuts and raisins. Pour batter into a greased 10-to 12-cup fluted tube dish. Cover with wax paper. Cook at **MEDIUM-HIGH** 13 to 14 minutes, or until top is dry and cake begins to pull away from side of pan. Let stand, uncovered, 10 minutes. Store, covered, until ready to serve.

BANANA NUT COFFEE CAKE

1/4 cup oil
1/4 cup milk
1 egg
1 mashed ripe banana
1/2 cup packed brown sugar
3/4 cup flour
1/2 cup chopped nuts
3/4 teaspoon baking powder
1/4 teaspoon salt
1/4 teaspoon baking soda

Nut Topping:

1/4 cup packed brown sugar
1/4 cup chopped nuts
2 tablespoons flour
1/8 teaspoon cinnamon
1 tablespoon butter or margarine, softened

Yield: 8 Servings

In medium bowl, combine oil, milk, egg, banana and sugar. Add flour, nuts, baking powder, salt and baking soda; stir only until flour is moistened. Pour into greased 8-or 9-inch round dish. In small bowl, prepare Nut Topping. Combine brown sugar, nuts, flour, and cinnamon; cut in butter. Sprinkle over batter. Cover with wax paper. Cook at **HIGH** 4 1/2 to 5 1/2 minutes, and at **LOW** 6 minutes, or until toothpick inserted near center comes out clean. Let stand, uncovered, 10 minutes. Store, covered, until ready to serve.

SOUTHERN CHEESE SPOON BREAD

1/2 cup yellow cornmeal
2 cups milk
1/2 teaspoon salt
2 eggs, beaten
1 cup (4 oz.) diced American cheese
2 tablespoons butter or margarine

Yield: 6 Servings

In medium glass bowl, combine cornmeal, milk and salt. Cook at **HIGH** 3 minutes and at **MEDIUM-HIGH** 3 to 4 minutes, or until cornmeal is thickened; stir twice. Stir until smooth; add eggs, cheese and butter. Stir until cheese and butter are almost melted. Pour into greased 8-inch round dish. Cover with wax paper. Cook at **MEDIUM** 7 to 9 minutes, or until center is almost set. Let stand 10 minutes before serving.

Directions for Cooking Fresh Vegetables

Weights given in the chart for fresh vegetables are the purchase weight before peeling and trimming. Prepare vegetables for cooking. Cut, slice, or trim as directed in chart. Place vegetables in casserole. Add amount of water recommended in chart. Whole vegetables, such as potatoes or eggplant, should be pierced with a fork several times before cooking. Arrange on microwave-safe dish in oven. Arrange potatoes in circular pattern on dish. Cook according to time recommended in chart. Two-thirds of the way through cooking stir, rearrange, and/or turn vegetables over. After cooking, stir vegetables. Let stand, covered, before serving. Vegetables that are cut into pieces should stand 3 minutes. Whole vegetables should stand 5 minutes. Never leave oven unattended when heating small amounts of foods such as one or two potatoes. Potatoes may catch on fire if overcooked and cause severe damage to the oven and surroundings.

Directions for Cooking Frozen Vegetables

For 9- to 10-ounce packages, remove vegetables from their package and place in 1- to 1½-quart casserole. Add 2 tablespoons water to frozen artichokes, brussels sprouts, sliced and whole okra and ½ cup water plus 1 tablespoon butter or margarine to frozen lima beans. Cover with lid or plastic wrap. Cook at **HIGH** 5 to 8 minutes or until slightly tender. Stir halfway through cooking and before stand time. Let stand, covered, 3 minutes before serving.

Frozen Vegetables in a Pouch

Remove pouch from package and place on a microwave-safe plate. Cut small slit in center of pouch. Cook at **HIGH**, following times on package directions (approximately 3¾ to 7 minutes, depending on vegetable). Let stand 2 minutes before serving.

Frozen Corn on the Cob

Rinse off any frost. Place frozen corn in a square dish. Cover with plastic wrap. Cook at **HIGH**. Rearrange and turn corn over halfway through cooking. Let stand, covered, 3 to 5 minutes before serving. Cook at **HIGH** as follows:
 1 ear: 4 to 5 ½ min. 2 ears: 7 to 9 min.
 3 ears: 9 to 11½ min. 4 ears: 12 to 14 min.

Fresh Vegetable Chart for Time Cooking

VEGETABLE	AMOUNT	WATER	APPROX. COOKING TIME at HIGH (in min.)
Artichokes, 6 to 8 oz. ea.	1	Rinsed	6 to 7½
	2	and	8½ to 10
	4	Drained	12½ to 14
Asparagus, 6-in. spears	1 lb.	¼ cup	5 to 6
Beans, Green or Wax, cut into 1½-in. pieces	1 lb	¼ cup	7½ to 8½
Broccoli, cut into spears	1 lb.	¼ cup	6 to 7
Brussels Sprouts	1 tub (10 oz.)	2 tablespoons	5½ to 7
Cabbage, shredded	4 cups (about 1 lb.)	¼ cup	7½ to 9
Carrots, sliced ½-in. thick	1lb.	¼ cup	8 to 9½
Corn, on the Cob	1 ear	2 tablespoons	3½ to 4½
	2 ears	2 tablespoons	4½ to 5½
	4 ears	¼ cup	9½ to 11
Eggplant, cubed Whole (pierce skin)	1 lb.	¼ cup	7 to 8½
	1 to 1¼ lb.	—	4½ to 6
Onions, small whole	8 to 10 (1 lb.)	¼ cup	6½ to 8
Peas, Green	1½ lb.	¼ cup	5 to 6½
Potatoes, about 8 oz. ea., Turn over halfway through cooking. Pierce skin several times.	1	—	4½ to 5½
	2	—	7 to 9
	4	—	12 to 14
Spinach, leaf	1 lb.	¼ cup	5½ to 6½
Squash, Spaghetti, about 2 to 3 lb., cut in half, scoop out seeds and place cut-side in dish.	1	¼ cup	9 to 11
Zucchini, sliced ½-in. thick	1 lb.	¼ cup	7 to 9

MICROWAVE SHORTCUTS

FOOD	POWER	TIME (In minutes)	DIRECTIONS
Butter, Melted, 1/4 pound Butter, Softened, 1/4 pound	MEDIUM MEDIUM-LOW	1 to 2 1/2 to 1	Remove wrapper and place butter in a microwave-safe dish.
Chocolate, Melted, 1 square (1 oz.) Chocolate, Melted, 1/2 cup chips	MEDIUM MEDIUM	2 to 3 2 to 3	Remove wrapper and place chocolate in dish. Stir before adding more time. Chocolate holds its shape even when softened.
Bacon, Separated, 1 lb.	HIGH	1/2 to 1	Remove wrapper. After heating, use a plastic spatula to separate slices.
Cream Cheese, Softened, 3 oz.	MEDIUM-LOW	1/2 to 1	Remove wrapper and place in a bowl.
Cup of Water 1 cup (8 oz.) 2 cups (16 oz.) Cup of milk 1 cup (8 oz.) 2 cups (16 oz.)	HIGH HIGH MEDIUM-HIGH MEDIUM-HIGH	4 6 1/2 3 1/2 to 4 1/2 7 to 8	Heated liquids can erupt if not mixed with air. Do not heat liquids in your microwave oven without stirring first.
Coconut, Toasted, 1/3 cup	HIGH	1 to 3	Place in a pie plate or bowl. Stir every 30 seconds.
Ground Beef, Browned, 1 lb.	HIGH	3 to 5	Crumble in microwave-safe colander set in another dish. Stir twice.
Ice Cream, Softened, 1/2 gallon	MEDIUM-LOW	3 to 4	
Nuts, Roasted, 1 1/2 cups	HIGH	3 to 5	Spread nuts in 9-inch pie plate. Stir twice.
Sesame Seeds, Toasted, 1/4 cup	HIGH	2 1/2 to 4	Place in a small bowl. Stir twice.
Brown sugar, Softened	HIGH	1/2 to 3/4	Place 1 cup hard brown sugar in dish with a slice of bread or a wedge of apple. Cover with plastic wrap.
To Remove Oven Odors	HIGH	5	Combine 1 to 1 1/2 cups of water with the juice and peel of one lemon in a small bowl. After heating, wipe interior of oven with damp cloth.

Questions and Answers

Q: I accidentally ran my microwave oven without any food in it. Is it damaged?

A: We do not recommend operating the microwave oven without any food. However, running the oven empty for a short time will not damage the oven.

Q: Why won't my oven turn on?

A: When the oven does not turn on, check the following:

1. Is the oven plugged in securely? Remove plug from outlet, wait 10 seconds and reinsert.
2. Check circuit breaker or fuse. Reset circuit breaker or replace fuse if it is tripped or blown.
3. If the circuit breaker or fuse is all right, plug another appliance into the outlet. If the other appliance works, there probably is a problem with the oven. If the other appliance does not work, there probably is a problem with the outlet.

If it seems there is a problem with the oven, contact an authorized Servicenter.

Q: The oven light turns on and the oven is programmed correctly, but it won't turn on.

A: Check to make sure the oven door is securely closed. If that was not the problem, contact the nearest authorized Servicenter.

Q: My microwave oven causes interference with my TV. Is this normal?

A: Some radio and TV interference might occur when you cook with the microwave oven. This interference is similar to the interference caused by small appliances such as mixers, vacuums, blow dryers, etc. It does not indicate a problem with your oven.

Q: The oven won't accept my program. Why?

A: The oven is designed not to accept an incorrect program. For example, the oven will not accept a fourth stage, and will not accept Auto Defrost after Auto start.

Q: Why does my oven light dim?

A: When cooking with a power other than HIGH, the oven must cycle to obtain the lower power levels. The oven light dims and clicking noises can be heard when the oven cycles.

Q: Why does steam accumulate on the oven door?

A: During cooking, steam is given off from the food. Most of the steam is removed from the oven by the air which circulates in the oven cavity. However, some steam will condense on cooler surfaces such as the oven door. This is normal.

Q: Sometimes warm air comes from the oven vents. Why?

A: The heat given off from the cooking food warms the air in the oven cavity. This warmed air is carried out of the oven by the air flow pattern in the oven. There are no microwaves in the air. The oven vents should never be blocked during cooking.

Q: Can foil frozen food trays be placed in the oven?

A: Frozen dinners or entrees may be heated in the foil tray, if the tray is less than 3/4-inch high. Remove tray from box. Remove foil cover. Cover with plastic cover or plastic wrap. Place foil tray in center of oven. Leave at least 1-inch space between foil tray and oven walls. Heat only 1 foil tray in the oven at a time.

What to Do When Service is Needed

If your Panasonic microwave oven needs service, look in the yellow pages of the telephone book under "Home Appliance Service" for your nearest Matsushita Services Company ("MSC") Factory Servicenter, or MSC authorized Servicenter, or call **800-545-2672**, toll free to find a convenient Servicenter. Do NOT send the product to the Executive or Regional Sales offices. They are NOT equipped to make repairs.

Consumers requiring product information or operating assistance with a consumer product should contact:
CONSUMER AFFAIRS DEPARTMENT 2F-3
50 Meadowland Parkway, Secaucus, N.J. 07094
(201) 348-9090

SERVICE HOTLINE
1-800-545-2672
Matsushita Services Co.

Technical Specifications

Power Source:	120 V, 60 Hz
Power Consumption:	13 Amps, 1,500 W
Output:*	800 W
Outside Dimensions:	16 ³ / ₈ " (H) × 29 ¹⁵ / ₁₆ " (W) × 14 ³ / ₁₆ " (D) 416 mm (H) × 760 mm (W) × 360 mm (D)
Oven Cavity Dimensions:	8 ³ / ₁₆ " (H) × 18 ⁵ / ₁₆ " (W) × 11" (D) 208 mm (H) × 465 mm (W) × 280 mm (D)
Operating Frequency:	2,450 MHz
Blower Fan:	210 cfm
Uncrated Weight:	59 lbs.

*IEC 705-88 Test procedure
Specifications subject to change without notice.

Panasonic®

just slightly ahead of our time®

**PANASONIC COMPANY, Division of
Matsushita Electric Corporation of America**
One Panasonic Way
Secaucus, N.J. 07094
(201) 348-7000

**Panasonic Sales Company, Division of
Matsushita Electric of Puerto Rico, INC.
(PSC)**
San Gabriel Industrial Park
65th Infantry Ave. KM. 9.5
Carolina, Puerto Rico 00630
(808) 750-5135

A00036030AP
F0491-0
Printed in Japan