

This Owner's Manual is provided and hosted by [Appliance Factory Parts](#).



PANASONIC NE-1258R Owner's Manual

[Shop genuine replacement parts for PANASONIC
NE-1258R](#)



[Find Your PANASONIC Microwave Parts - Select From 742 Models](#)

----- Manual continues below -----

Operating Instructions

Commercial Microwave Ovens

NE-1257R/NE-1258R/NE-1757R/NE-2157R

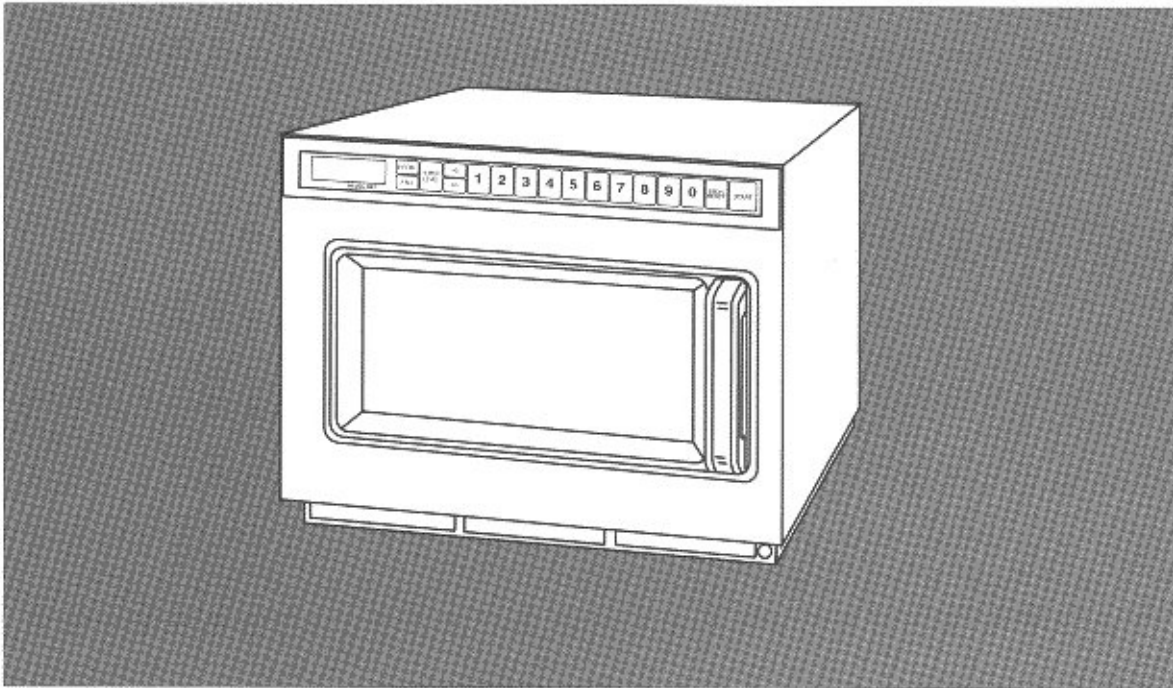

Please read these instructions completely before operating this oven.

Before Calling for Service:

If failure code "F**" appears in the display, unplug oven and wait for 10 seconds before reconnecting. If normal operation does not resume, call the service agent with the information of failure code.

Contents

PRECAUTIONS TO AVOID POSSIBLE EXPOSURE TO EXCESSIVE MICROWAVE ENERGY	3
IMPORTANT SAFETY INSTRUCTIONS	3
Installation and Grounding Instructions	4
Caution	4
Power Source Voltage Adjustment	5
How Does The Microwave Work?	5
Outline Diagram	6
How to Operate	
A. Manual Heating ..single stage heating	7
.....2 or 3 stage heating	8
B. Programmed Heating	9
C. Programming Number/Memory pads ..single stage heating	9
.....2 or 3 stage heating	10
D. Programming Double or Triple Quantity pad	11
E. Program Lock	11
F. Beep Tone	12
G. Program List	13
H. Cycle Counter	13
I. Air Filter	14
Installation Instructions for Stacking	15
Sanitary Counter Top Seal	15
Care of Your Oven	16
Self Diagnostics Failure Code Explanation	17
Heating and Defrosting Time Charts	18
Technical Specifications	32

Owner's Record

Model No. _____

Serial No. _____

The serial number of this products
may be found on the side of the oven.

Dealer's Name _____

Dealer's Address _____

Date of Purchase _____

See page 17 before calling

Toll Free Service Information

To locate a convenient service agent call

1-888-350-9590

Chef Support: 201-348-7305

www.panasonic.com/cmo

Virtual Test Kitchens

PRECAUTIONS TO AVOID POSSIBLE EXPOSURE TO EXCESSIVE MICROWAVE ENERGY

- (a) **Do not attempt to operate this oven with the door open** since open-door operation can result in harmful exposure to microwave energy. It is important not to defeat or tamper with the safety interlocks. Under normal conditions, the oven will not operate with the door open.
- (b) **Do not place any object** between the oven front face and the door, or allow soil or cleaner residue to accumulate on sealing surfaces.
- (c) **Do not operate the oven** if it is damaged. It is particularly important that the oven door close properly and that there is no damage to the :
 - (1) door (bent)
 - (2) hinges and latches (broken or loose)
 - (3) door seals and sealing surfaces.
- (d) **The oven should not be adjusted or repaired** by anyone except properly qualified service personnel.

IMPORTANT SAFETY INSTRUCTIONS

Your microwave oven is a cooking device and you should use as much care as you use with a stove or any other cooking device.

When using this electric appliance, basic safety precautions should be followed, including the following:

WARNING—To reduce the risk of burns, electric shock, fire, injury to persons or exposure to excessive microwave energy:

1. Read all instructions before using the appliance.
2. Read and follow "**PRECAUTIONS TO AVOID POSSIBLE EXPOSURE TO EXCESSIVE MICROWAVE ENERGY,**" found on page 3.
3. This appliance must be grounded. Connect only to a properly grounded outlet. See "**Grounding Instructions**" found on page 4.
4. Install or locate this appliance only in accordance with the provided installation instructions found on page 4.
5. Do not cover or block any openings on this appliance.
6. Do not store or use this appliance outdoors. Do not use this product near water for example, near a kitchen sink, in a wet basement, or near a swimming pool, and the like.
7. Use this appliance only for its intended use as described in this manual. Do not use corrosive chemicals or vapors in this appliance. This type of oven is specifically designed to heat, or cook food. It is not designed for industrial or laboratory use.
8. When cleaning surfaces of door and oven that come together on closing the door, use only mild, non-abrasive soaps or detergents applied with a sponge or soft cloth.
9. As with any appliance, close supervision is necessary when used by children.
10. Do not operate this appliance if it has a damaged cord or plug, if it is not working properly, or if it has been damaged or dropped.
11. Do not immerse cord or plug in water.
12. Keep cord away from heated surfaces.
13. Do not let cord hang over edge of table or counter.
14. This appliance should be serviced only by qualified service personnel. Contact the nearest authorized service facility for examination, repair or adjustment.
15. Some products such as whole eggs and sealed containers (for example, closed glass jars) may explode and should not be heated in this oven.
16. To reduce the risk of fire in the oven cavity:
 - (a) Do not overcook food. Carefully attend appliance if paper, plastic, or other combustible materials are placed inside the oven to facilitate cooking.
 - (b) Remove wire twist-ties from paper or plastic bags before placing bag in oven.
 - (c) If materials inside the oven should ignite, keep oven door closed, turn oven off, and disconnect the power cord, or shut off power at the fuse or circuit breaker panel.
 - (d) Do not use the cavity for storage purposes. Do not leave paper products, cooking utensils, or food in the cavity when not in use.

SAVE THESE INSTRUCTIONS

For proper use of your oven read remaining safety cautions and operating instructions.

Installation and GROUNDING INSTRUCTIONS

Placement of the Oven

Locate the oven on a smooth, flat and stable surface. There should be no gap between the table surface and the bottom of the oven. Do not place the oven in a hot or damp area, ie. near a stove, sink or directly above heat lamps on a serving line. Free airflow around the oven is important. There is a possibility of a small amount of interference with weak broadcast signals if the microwave oven is too close to a radio or TV.

Grounding Instructions

This oven must be grounded electrically. In the event of an electrical short circuit, grounding reduces the risk of electric shock by providing an escape wire for the electric current. The appliance is equipped with a cord having a grounding wire with a grounding plug. The plug must be plugged into an outlet that is properly installed and grounded.

WARNING — improper use of the grounding plug can result in a risk of electric shock.

Consult a qualified electrician or service person if the grounding instructions are not completely understood, or if doubt exists as to whether the appliance is properly connected.

If it is necessary to use an extension cord, use only a three wire extension cord that has a three blade grounding plug, and a three slot receptacle that will accept the plug on the appliance. The marked rating of the extension cord should be equal to or greater than the electrical rating of the oven.

Removal of Protective Film

A blue protective film is used to prevent scratching of the outer case during transportation. Peel the film from the exterior of the oven before installation or use.

Wiring Requirements

No other appliance should share the circuit with the microwave oven. If it does, the branch circuit fuse may overload and either cause the oven to heat slower than

expected or blow the fuse.

A. For Model NE-1257/NE-1258

The oven must be on a SEPARATE, 20 amp, 60 Hz-120 V GROUNDED CIRCUIT.

NEMA#
5-20P

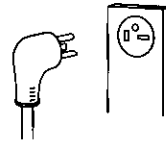

120 V
Grounded
Outlet
NEMA# 5-20R

B. For Models NE-1757/NE-2157

1. This oven must be on a separate, 60 Hz GROUNDED CIRCUIT - minimum 15 amps for NE-1757; minimum 20 amps for NE-2157.
2. The microwave ovens are built to operate on 2 different voltages (230-240 V or 208 V). Be sure that the voltage selector connector (on the back of the oven) is set for your power supply (see page 5). Using a higher voltage setting is dangerous and may result in overheating of the electrical components thus shortening their life expectancy or possibly causing a fire or other accident. Using a lower voltage will lower the power output of the oven, resulting in slower heating of the food. Panasonic is NOT responsible for damage resulting from the use of the oven with other than the specified voltage.

NE-1757

NE-2157

NEMA#
6-15P

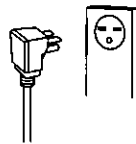

208 V/230-240 V
Grounded Outlet
NEMA# 6-15R or 6-20R

NEMA#
6-20P

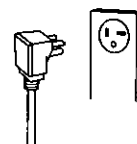

208 V/230-240 V
Grounded Outlet
NEMA# 6-20R

Caution

1. Do not attempt to tamper with or make any adjustments or repairs to the door, control panel housing, safety interlock switches or any other part of the oven. Do NOT remove the outer panel of the oven. Repairs should only be done by a qualified service person.
2. Do NOT operate the oven empty. The microwave energy will reflect continuously throughout the oven if no food or water is present to absorb energy.
3. If a fire occurs in the oven, press the Stop/Reset Pad and LEAVE THE DOOR CLOSED. Disconnect the power cord, or shut off the power at the fuse or circuit breaker panel.
4. Do NOT attempt to dry clothes, newspapers or other materials in the oven, as they may catch on fire.
5. Do NOT use recycled paper products, as they may contain impurities which may cause sparks and/or fires.
6. Do NOT use newspapers or paper bags for cooking.
7. Do NOT hit or strike the control panel. Damage to controls may occur.
8. POT HOLDERS may be needed when removing food from the oven. Heat is transferred from the hot food to the container.
9. Do NOT store flammable materials next to, on top of, or in the oven. It could be a fire hazard.
10. Do NOT operate the oven without the spatter shields (located in the top of inner cavity) in place.

Power Source Voltage Adjustment

The microwave oven Models NE-1757 and NE-2157 are factory set for 208 V operation. For 230 V - 240 V operation, the following adjustment MUST be made.

- (Step 1) Make sure that the power cord is unplugged before removing the voltage adjustment panel cover.
- (Step 2) Unscrew the voltage adjustment panel cover which is located on the back of the oven. Do not remove any other parts from the oven.
- (Step 3) Remove the white connector and plug the black connector into the socket.
- (Step 4) Store the unused white connector in the rectangular opening.
- (Step 5) Reattach the voltage adjustment panel cover to the cabinet.

For 230 V - 240 V – Use black connector plug.
For 208 V – Use white connector plug.

To go from 230 V - 240 V to 208 V circuit follow steps 1-5 above, except at step 3, plug the white connector plug into the socket and store the black plug in the rectangular opening.

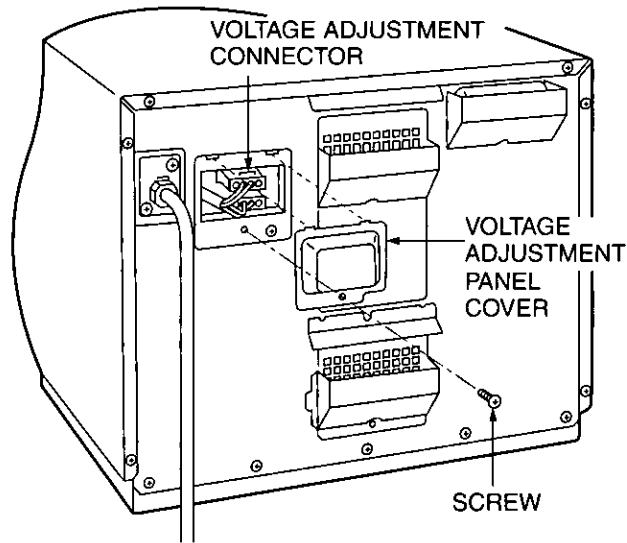

How Does The Microwave Work?

Microwaves are a form of high frequency radio waves similar to those used by a radio including AM, FM, and CB. They are, however, much shorter than radio waves; approximately five inches long. Electricity is converted into microwave energy by the magnetron tube. From the magnetron tube, microwave energy is transmitted to the oven cavity where it is: reflected, transmitted and absorbed.

Reflection

Microwave are reflected by metal just as a ball is bounced off a wall. A combination of stationary (interior walls) and rotating antenna, located underneath the bottom shelf and above the ceiling cover assure that the microwaves are well distributed within the oven cavity to produce even heating or cooking of foods.

Transmission

Microwave pass through some materials such as paper, glass and plastic much like sunlight shining through a window. Because these substances do not absorb or reflect the microwave energy, they are ideal materials for microwave oven heating containers when covered.

Absorption

During heating, microwaves will be absorbed by food. They penetrate to a depth of about $\frac{3}{4}$ to $1\frac{1}{2}$ inches. Microwave energy excites the molecules in the food (especially water, fat and sugar molecules), and causes them to vibrate at a rate of 2,450,000,000 times per second. This vibration causes friction, and heat is produced just as you will feel heat produced if you vigorously rub your hands together. The internal heating of larger foods is done by conduction. The heat which is produced by friction is conducted to the center of the food. Foods also continue to heat by conduction during standing time. ("carry-over" cooking)
Because microwaves dissipate, much like sunlight as it reaches the Earth's surface, they are not stored in food.

Radio Interference

1. Operation of the microwave oven may cause interference to your radio, TV or similar equipment.
2. When there is interference, it may be reduced or eliminated by taking the following measures:
 - a. Clean door and sealing surfaces of the oven.
(See Care of Your Microwave Oven found on page 16.)
 - b. Place the radio, TV, etc. away from the microwave oven as far as possible.
 - c. Use a properly installed antenna, to obtain stronger signal reception.

Outline Diagram

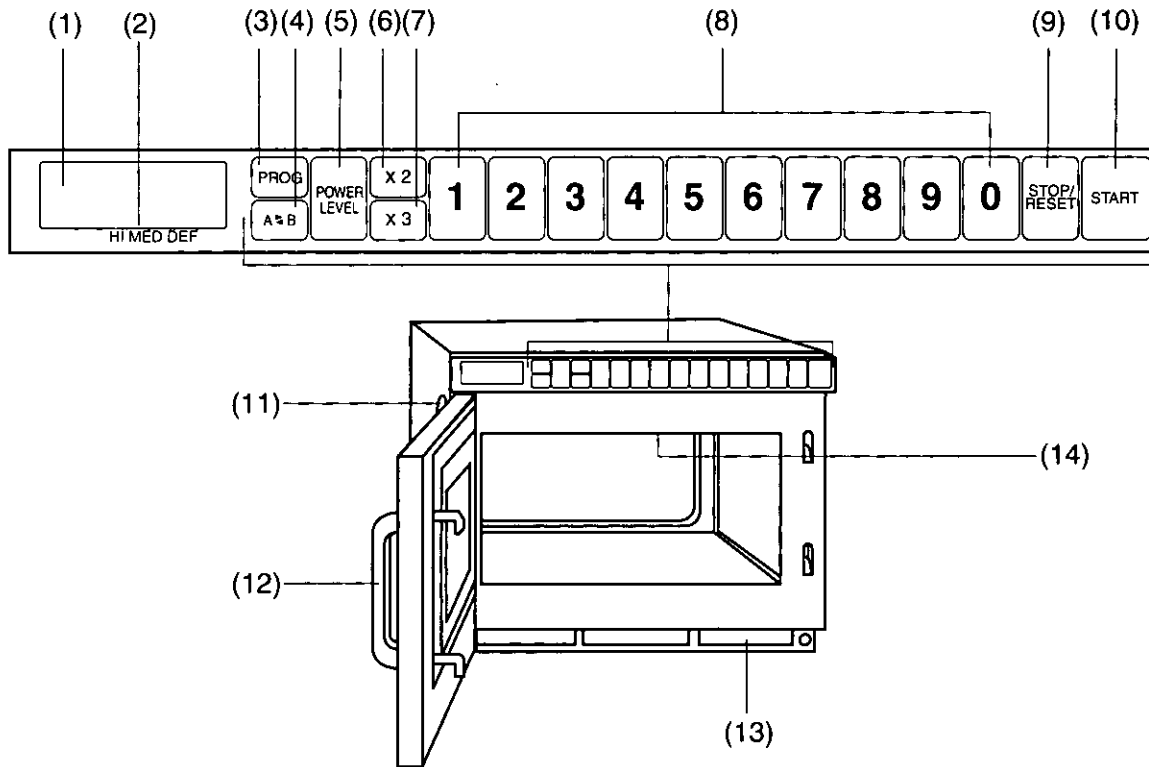

- | | |
|----------------------------------------|--------------------------------------------|
| (1) Digital Display Window (see below) | (8) Number/Memory pads |
| (2) Power Level Indicator Display | (9) Stop/Reset pad |
| (3) Program pad | (10) Start pad |
| (4) Shift (A/B) pad | (11) Oven Lamp Cover |
| (5) Power Level Selector pad | (12) Door Handle |
| (6) Double Quantity pad | (13) Air Filter |
| (7) Triple Quantity pad | (14) Splatter Shield (top of inner cavity) |

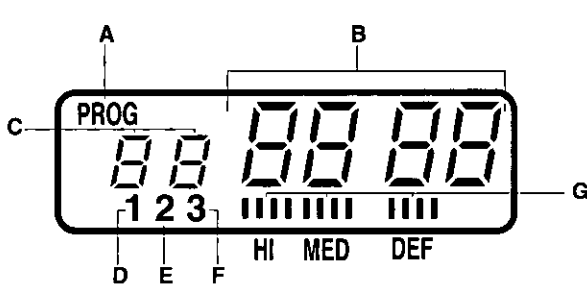

- | |
|--------------------------------------|
| A — Program Display |
| B — Heating Time Display (min. sec.) |
| C — Memory Pad Number Display |
| D — 1st Stage Heating Indicator |
| E — 2nd Stage Heating Indicator |
| F — 3rd Stage Heating Indicator |
| G — Power Level Indicator |

This oven is preset at the factory as follows:

- ◆ Manual operation
 - ◆ Number/Memory pads preset HIGH power at the indicated heating times for single stage heating









1 = 10 sec.	2 = 20 sec.	3 = 30 sec.	4 = 40 sec.	5 = 50 sec.
6 = 1 min.	7 = 1 min. 15 sec.	8 = 1 min. 30 sec.	9 = 1 min. 45 sec.	0 = 2 min.

 (There are two sides, A and B. Only A-side is preset.)
 - ◆ Program Unlocked
 - ◆ Cycle Counter set to "0" on all pads
- If you wish to change these settings, please consult the operating instructions for programming procedure.

How to Operate

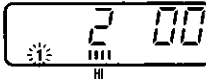
A. MANUAL HEATING — single stage heating —

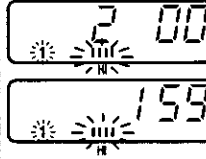
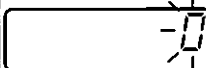









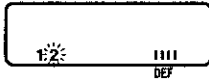

Example: To cook food at HIGH power for 2 minutes

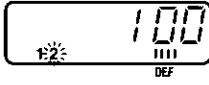
	PAD	INSTRUCTION	DIGITAL DISPLAY WINDOW
1		<p>Open the door and put the food in the oven.</p> <p>☛ The oven lamp will turn on and "0" will appear.</p> <p>Note: While "0" appears, operation is available. One minute after the door is closed, "0" will disappear.</p>	
2		<p>Press Power Level Selector pad once.</p> <p>☛ The selected power level will be indicated and 1st Stage Heating Indicator "1" will start to blink.</p> <p>Note: To select HIGH power, press once. To select MEDIUM power, press twice. To select DEFROST power, press three times.</p>	
3		<p>Press Number/Memory pads "2", "0" and "0".</p> <p>☛ The set heating time will appear.</p> <p>Note: up to 15 min. on HIGH or MEDIUM power, 30 min. on DEFROST</p>	
4		<p>Press Start pad.</p> <p>☛ The oven lamp will turn on and heating will start. Power Level Indicator will start to blink, and heating time will count down.</p>	
<ul style="list-style-type: none"> • When all time expires, beep tone will sound and heating will stop. The oven lamp will turn off. "0" will blink until the door is opened. One minute later, cooling fan will stop. • Open the door and take the food out. The oven lamp will turn on. Digital Display Window will show the originally selected time and power. • Close the door. The oven lamp will turn off. One minute later, Digital Display Window will go blank. 			  

How to Operate

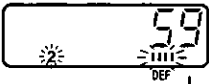
A. MANUAL HEATING — 2 or 3 stage heating —

Example: To cook food at HIGH power for 2 minutes and at DEFROST power for 1 minute

PAD	INSTRUCTION	DIGITAL DISPLAY WINDOW
	Follow steps 1 to 3 on page 7.	
4 	Press Power Level Selector pad three times. • The selected power level will be indicated and 2nd Stage Heating Indicator "2" will start to blink.	
5 	Press Number/Memory pads "1", "0" and "0". • The set heating time will appear. Note: up to 15 min. on HIGH or MEDIUM power, 30 min. on DEFROST	
6 	Press Start pad. • The oven lamp will turn on. The total time for both stages will appear and start to count down. 1st Stage Heating Indicator "1" and Power Level Indicator for the first stage heating will start to blink.	 
<ul style="list-style-type: none"> • After the first stage heating, beep tone will sound. 2nd Heating Stage Indicator "2" and Power Level Indicator for the second stage heating will start to blink and the remaining heating time will count down. • When all time expires, beep tone will sound and heating will stop. The oven lamp will turn off. "0" will blink until the door is opened. One minute later, cooling fan will stop. • Open the door and take the food out. The oven lamp will turn on. Digital Display Window will show the originally set time and power. • Close the door. The oven lamp will turn off. One minute later, Digital Display Window will go blank. 		   

Note: For 3 stage heating, select a power level once again after step 5 and set a heating time.

SPECIAL NOTE: For both single and 2 stage heating

1. While heating, one touch on Stop/Reset pad stops the operation. You can restart it by pressing Start pad or a second touch on Stop/Reset pad will cancel the selected program.
2. While not heating, one touch on Stop/Reset pad cancels the selected program.
3. You can repeat exactly the same manually selected heating time by pressing only Start pad you use the oven again within one minute.
4. One minute later of non-use with door closed, the repeat feature will be cancelled.

How to Operate

B. PROGRAMMED HEATING

◆ In Program Unlock Mode:

Example: To select Number/Memory pad "3" at A side in which your desired heating program (at HIGH power for 3 min., single stage heating) is set

	PAD	INSTRUCTION	DIGITAL DISPLAY WINDOW
1		Open the door and put the food in the oven. • The oven lamp will turn on and "0" will appear. Note: While "0" appears, operation is available. One minute after the door is closed, "0" will disappear.	
2		Press the desired Number/Memory pad "3". • The currently programmed information will be indicated.	
3		Press Start pad. • The oven lamp will turn on and heating will start. The heating time will count down.	
<ul style="list-style-type: none"> • When all time expires, beep tone will sound and heating will stop. The oven lamp will turn off. "0" will blink until the door is opened. One minute later, cooling fan will stop. • Open the door and take the food out. The oven lamp will turn on. • Close the door. The oven lamp will turn off. One minute later, Digital Display Window will go blank. 			

Note:

- When you want to select the number at B side, press Shift (A/B) pad before pressing the desired Number/Memory pad.

◆ In Program Lock Mode:

Just press the desired Number/Memory pad. Heating will automatically start without pressing Start pad.

✍ For Double (or Triple) Quantity heating:

Press Double (or Triple) Quantity pad before pressing the desired Number/Memory pad.







C. PROGRAMMING NUMBER/MEMORY PADS — single stage heating —

**THE OVEN CAN NOT BE PROGRAMMED WHEN PROGRAM LOCK IS ACTIVATED! (see page 11-12)
DO NOT OPEN THE DOOR WHILE PROGRAMMING!**

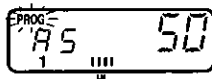
Example: To program cooking at DEFROST power for 1 minute into Number/Memory pad "5"

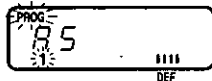
	PAD	INSTRUCTION	DIGITAL DISPLAY WINDOW
1		Keep the door closed. • Digital Display Window must be blank.	
2		Press Program pad. • "PROG" will start to blink.	

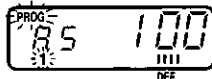
How to Operate

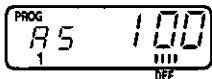
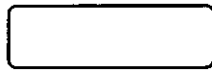

3		<p>Press Number/Memory pad "5".</p> <ul style="list-style-type: none"> The selected pad number will appear and currently programmed information will be indicated. 	
4		<p>Press Power Level Selector pad three times.</p> <ul style="list-style-type: none"> The selected power level will be indicated, 1st Stage Heating Indicator "1" will start to blink, and Heating Time Display will go blank. 	
5		<p>Press Number/Memory pads "1", "0" and "0".</p> <ul style="list-style-type: none"> The set heating time will appear. <p>Note: up to 15 min. on HIGH or MEDIUM power, 30 min. on DEFROST</p>	
6		<p>Press Program pad.</p> <ul style="list-style-type: none"> "PROG" and 1st Stage Heating Indicator "1" will stop blinking. This means that you have completed programming. 	
<ul style="list-style-type: none"> Three seconds later, Digital Display Window will go blank. 			

- Note:**
- Program the remaining Number/Memory pads as desired by repeating steps 1-6 above.
 - When "PROG" is blinking in Digital Display Window, the program can be cancelled and/or one touch on Stop/Reset pad erases the programmed Number/Memory pad number.
 - When you want to program the B side, press Shift (A/B) pad before selecting the desired Number/Memory pad.

C. PROGRAMMING NUMBER/MEMORY PADS — 2 or 3 stage heating —

**THE OVEN CAN NOT BE PROGRAMMED WHEN PROGRAM LOCK IS ACTIVATED! (see page 11-12)
DO NOT OPEN THE DOOR WHILE PROGRAMMING!**

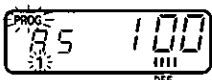
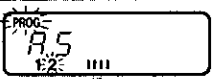
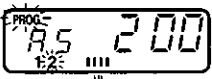
Example: To program cooking at DEFROST power for 1 minute and at HIGH power for 2 minutes into Number/Memory pad "5"

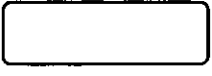
PAD	INSTRUCTION	DIGITAL DISPLAY WINDOW
	Follow steps 1 to 5 above.	
6	<p>Press Power Level Selector pad once.</p> <ul style="list-style-type: none"> The power level for 2nd stage will be indicated, 2nd Stage Heating Indicator "2" will start to blink, and Heating Time Display will go blank. 	
7	<p>Press Number/Memory pads "2", "0" and "0".</p> <ul style="list-style-type: none"> The set heating time will appear. <p>Note: up to 15 min. on HIGH or MEDIUM power, 30 min. on DEFROST</p>	
8	<p>Press Prog pad.</p> <ul style="list-style-type: none"> "PROG" and 2nd Stage Heating Indicator "2" will stop blinking. The total time for both stages will appear. This means that you have completed programming. 	
<ul style="list-style-type: none"> Three seconds later, Digital Display Window will go blank. 		

- Note:**
- Program the remaining Number/Memory pads as desired by repeating steps above.
 - When "PROG" is blinking in Digital Display Window, the program can be cancelled and/or one touch on Stop/Reset pad erases the programmed Number/Memory pad number.
 - When you want to program the B side, press Shift (A/B) pad before pressing Number/Memory pad.
 - For 3 stage heating, select a power level once again after step 7 and enter the time desired.

How to Operate

D. PROGRAMMING DOUBLE OR TRIPLE QUANTITY PAD

THE OVEN CAN NOT BE PROGRAMMED WHEN PROGRAM LOCK IS ACTIVATED! (see page 11-12)
DO NOT OPEN THE DOOR WHILE PROGRAMMING!

Example: To program 1.5 times of heating time for double quantity into Number/Memory pad "5"

PAD	INSTRUCTION	DIGITAL DISPLAY WINDOW
1	Keep the door closed. ☛ Digital Display Window must be blank.	
2	Press Prog pad. ☛ "PROG" will start to blink.	
3	Press Number/Memory pad "5". ☛ The selected pad number will appear and currently programmed information will be indicated.	
4	Press Double Quantity pad. ☛ The currently programmed magnification number will appear. Note: 1.6 times is preset at factory.	
5	Press Number/Memory pads "1" and "5" for 1.5 times. ☛ The programmed magnification number will appear. If pad 5 is programmed for 3 minutes, the time for the double quantity will be 4 minutes and 30 seconds. Available range is 0.1-5.0 times.	
6	Press Prog pad. ☛ "PROG" will stop blinking. This means that you have completed programming.	
• Three seconds later, Digital Display Window will go blank.		

Note:

- If you want to program your desired magnification number for triple quantity, repeat as above, using Triple Quantity pad instead of Double Quantity pad.

E. PROGRAM LOCK

◆ To Activate Program Lock:

PAD	INSTRUCTION	DIGITAL DISPLAY WINDOW
1	Keep the door closed. ☛ Digital Display Window must be blank.	
2	Press Prog pad until "PROG", "P" and "L" appear. (more than five seconds) ☛ "PROG", "P" and "L" will appear.	

In Program Lock mode:

- The oven is started by pressing the desired Number/Memory pad. There is no need to press Start pad.
- Opening the door cancels the remaining time on the program.
- The oven can not be programmed or run manually until the program lock is released.

How to Operate

◆ To Release Program Lock:

	PAD	INSTRUCTION	DIGITAL DISPLAY WINDOW
1		Open the door and leave it open. • The oven lamp will turn on, and "0" will appear.	
2	+	While pressing Stop/Reset pad, press Prog pad until "PROG" and "P" appear. (more than five seconds) • "PROG" and "P" will appear.	

In Program Unlock mode:

- Oven reverts to a two-touch operating mode (Number/Memory pad + Start pad).
- Repeat and interrupt feature are operational.
- Number/Memory pads can be programmed.
- Tone loudness control and length control are operational.

F. BEEP TONE

The loudness of beep tone and the length of beep tone at the end of heating cycle can be set.

There are four levels of the loudness. The level is indicated by a number followed by the word "bEEP".

- 3bEEP = loudest
- 2bEEP = middle
- 1bEEP = quietest
- 0bEEP = silent

There are two options of the length of beep tone at the end of heating cycle. The length is indicated by 1 st or 2 nd Stage Heating Indicator.

- 1 = 3 beeps
- 2 = short beeps for 60 seconds

The loudest level and 3 beeps are preset at the factory.

◆ To Select Loudness Level and Length "3 beeps":

Example: To select loudest beep tone

	PAD	INSTRUCTION	DIGITAL DISPLAY WINDOW
1		Open the door and leave it open. • The oven lamp will turn on and "0" will appear.	
2		Press Prog pad.	
3		Press Number/Memory pad "0" once. • The tone will sound at its loudness level and the loudness level "3" followed by the word "bEEP" will appear. "PROG" will start to blink and 1st Stage Heating Indicator "1" (the length of beep tone "3 beeps") will be indicated. Note: Repeating to press the pad "0" will lower the loudness all the way to silent. (3 bEEP — loudest, 2 bEEP — middle, 1 bEEP — quietest, and 0 bEEP — silent)	
4		Press Prog pad. • "PROG" will stop blinking. That means that you have completed program. Three seconds later, "0" will appear.	
• Close the door. One minute later, Digital Display Window will go blank.			

How to Operate

☞ For selecting length of tone “short beeps for 60 seconds”:

Example: To select short beeps for 60 seconds

PAD	INSTRUCTION	DIGITAL DISPLAY WINDOW
	Follow step 1-4 on page 12. DO NOT CLOSE THE DOOR!	
5 	Within three seconds after pressing Prog pad at step 4, press Number/Memory pad “0” once. ☛ “PROG” will start to blink and 2nd Stage Heating Indicator “2” (the length of beep tone “short beeps for 60 seconds”) will be indicated.	
6 	Press Prog pad. ☛ “PROG” will stop blinking. This means that you have completed programming. Three seconds later, “0” will appear.	
• Close the door. Digital Display Window will go blank.		

G. PROGRAM LIST

PAD	INSTRUCTION	DIGITAL DISPLAY WINDOW
1	Open the door and leave it open. ☛ The oven lamp will turn on and “0” will appear.	
2 +	While pressing Stop/Reset pad, press Start pad. ☛ All currently programmed information (the program set into each Number/Memory pad (A/B sides), Beep Tone, and Program Lock information) will continuously appear.	e.g.

H. CYCLE COUNTER

◆ To Check The Number Of Cycles That The Oven Has Been Used In Manual Mode:

PAD	INSTRUCTION	DIGITAL DISPLAY WINDOW
1	Open the door and leave it open. ☛ The oven lamp will turn on and “0” will appear.	
2 +	While pressing Stop/Reset pad, press Power Level Selector pad. ☛ The number of cycles that the oven has been used in manual mode will appear.	e.g.

How to Operate

◆ To Read The Number Of Times Each Memory Pad Has Been Used:

Example: To read the number of times of Number/Memory pad "3" at A side (6666 times used)

	PAD	INSTRUCTION	DIGITAL DISPLAY WINDOW
1		Open the door and leave it open. ☛ The oven lamp will turn on and "0" will appear.	
2	+	While pressing Stop/Reset pad, press Number/Memory pad "3". ☛ The number of times this Number/Memory pad has been used will appear.	e.g.

Note:

- To read B side, press Shift (A/B) pad while the display is still showing the number of cycles.

◆ To Read Total Cumulative Cycles That The Oven Has Been Used:

Close the door while the display is still showing the number of cycles that each pad has been used. The total cumulative cycles that the oven has been used in Number/Memory pads at A/B sides and manual mode will appear.

I. AIR FILTER

Example: To program cleaning Air Filter every 600 hours

	PAD	INSTRUCTION	DIGITAL DISPLAY WINDOW
1		Open the door and leave it open. ☛ The oven will turn on and "0" will appear.	
2		While pressing Start pad, close and open the door.	
3		Press Number/Memory pad "3". ☛ The currently programmed hour will appear.	e.g.
4		Press Number/Memory pads "6", "0" and "0". ☛ The programmed hour will appear. Note: up to 9999 hours	e.g.
5		Press Prog pad. ☛ Three seconds later, "0" will appear.	

Note: When "FILT" sign appears in Digital Display Window, remove Air Filter and clean it with soapy water. Press Stop/Reset pad to clear the display.

To check the total number of hours used,

- ◆ Open the door and leave it open.
- ◆ Press Number/Memory pad "3" while pressing Start pad.
- ◆ The total number of hours used and "H" will appear in Digital Display Window.
e.g. If the oven has been used for 20 hours,

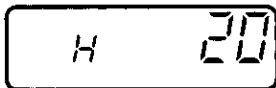

Three seconds later, "0" will appear in Digital Display Window.

Note: If the oven cuts out after short operation, check if Air Filter is clean before calling for service.

Installation Instructions for Stacking

IMPORTANT

1. Disconnect the power cord from the wall socket before attempting installation.
2. For stacking installation, you must use the PANASONIC Joint Plate which is enclosed with this unit.
3. The combination of the units for stacking is limited to only the following PANASONIC models:

NE-1247, NE-1257, NE-1258, NE-1757, NE-2157, NE-DF20G

4. The **maximum** stacking height is the total heights of two units.

PREPARATION

Be sure the oven cavity is empty. Be sure surfaces where ovens meet is clean and sanitized.

INSTALLATION

1. Stack the units and remove five screws (a) as shown in Fig. 1.
2. Loosen the screw (b).
3. Projection on Joint Plate must face away from the oven. Place Joint Plate on the screw (b).
4. Attach and tighten five screws (a) and the screw (b). See Fig. 2.
5. Ensure the top oven is at a safe and workable height.

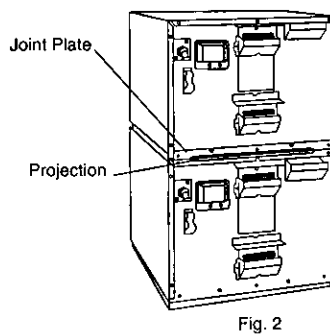
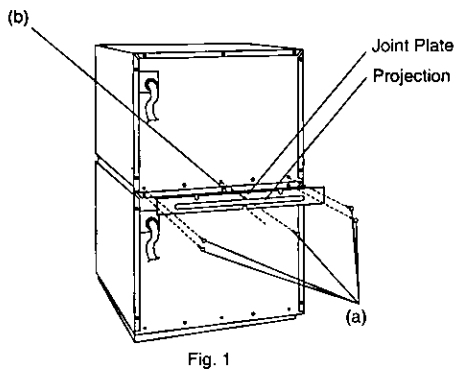

Sanitary Counter Top Seal

When microwave oven units are stacked on a counter top, their base must be sealed in accordance with N.S.F. Standards as per the following instructions.

1. Microwave oven should be located on a level counter top surface. Complete the electrical connections.
2. Thoroughly clean the microwave oven bottom perimeter and the counter top area around the microwave oven perimeter.
3. Lay generous bead of silicone seal around the entire perimeter of the base of each microwave oven unit.
4. Smooth the silicone seal into the crevice with finger or tool to provide a cove seal.

Note: Remove the Air Filter from the front of the oven before applying silicone. DO NOT FORGET to re-install the Air Filter after applying silicone.

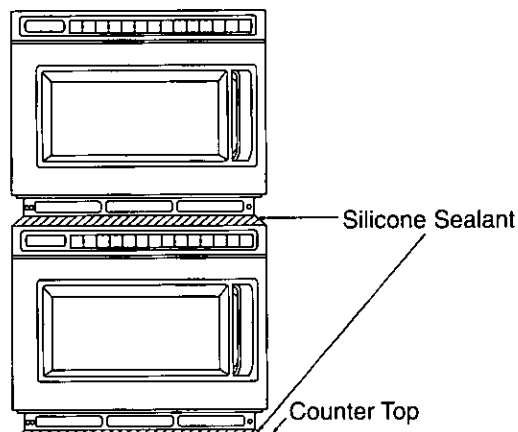

Care of Your Oven

1. Remove the plug from the electrical socket before cleaning.
2. Keep the inside of the oven clean. If pieces of food or spilled liquids stick to the oven walls, or between door seal and door surface, they will absorb microwaves and may cause arcing or sparks. Wipe up all spills with a damp cloth. Kitchen detergent or an approved sanitizing solution may be used if the oven gets very dirty. Do not use harsh detergents or abrasives.
3. The outside surface of this microwave oven should be cleaned with soap and water, then dried with a soft cloth. Make sure that water does not get into the back ventilation or control panel opening since this can damage the unit.
4. The window of the door should be washed with very mild soap and water. Be sure to use a soft cloth. Never use window cleaner. The front door can be scratched by harsh soap or cleaners.

CLEANING OF THE SPLATTER SHIELD

1. Hold snap in-snap out side stoppers of splatter shield with both hands and pull them in and down. Then take the splatter shield out of the oven cavity.

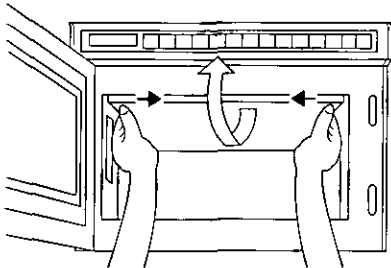

2. Rinse splatter shield in soapy water and an approved sanitizing solution.
3. Be sure to replace the shield before using the oven.

CAUTION

Splatter shield must be in place securely when you use the oven.

REPLACEMENT OF THE CAVITY LIGHT BULB

If the Cavity Light burns out, you can replace it yourself by following these simple directions.

1. Unscrew the Cavity Light Cover which is located on the left side of the cabinet.
2. Remove the cellophane tape that is placed over the bulb and the socket.
3. Replace the old bulb with a new one.
4. Close the Cavity Light Cover.
use 120 V - 125 V / 20 W for NE-1257R/NE-1258R
use 230 V - 250 V / 20 W for NE-1757R
use 230 V - 250 V / 20 W for NE-2157R

CAUTION

Remove the plug from the electrical socket before replacement of the Cavity Light Bulb.

CLEANING THE AIR FILTER

Clean the Air Filter regularly according to the following instructions. The oven may have problems when the Air Filter becomes clogged with dust. (*)

1. Remove Air Filter from the front bottom skirt by returning the right screw to the left. Then slide the filter to the right and lift it off the post at the left.

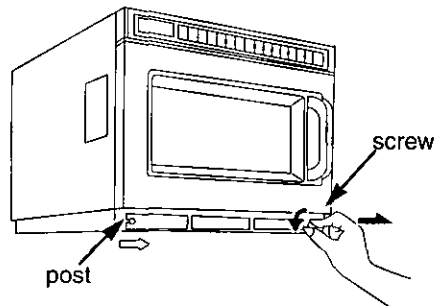

2. Wash this filter in warm soapy water.
3. Be sure to replace Air Filter before using the oven.

(*) If Air Filter becomes clogged with debris this will cause an overheating problem on the oven.- See "F" codes on page 17.

Self Diagnostics Failure Code Explanation

This oven monitors its operation and displays a Failure Code in Digital Display Window when a problem occurs.

What to do when a Failure Code appears:

Unplug the oven and wait more than ten seconds before reconnecting.

If normal operation does not resume, follow the next chart.

CODE	PROBLEM	WHAT TO DO						
F01	Too high temperature of exhausted air	The oven shuts off automatically. Disconnect the power cord from the wall socket. The oven beeps continuously and resets for operation when cool. Move the oven to the cooler location. If the problem persists, call service agent.						
F03	Incoming line voltage too high. <div style="border: 1px solid black; padding: 2px; width: fit-content;">This oven is designed to operate with 208 or 230 - 240 Volts AC.</div>	Check line voltage and that voltage adjustment is matched. (Refer to page 5 for Power Source Voltage Adjustment.) <table style="margin-left: auto; margin-right: auto;"> <tr> <td style="padding: 0 10px;">Line Volt.</td> <td style="padding: 0 10px;">Connector Color</td> </tr> <tr> <td style="padding: 0 10px;">208 V</td> <td style="padding: 0 10px;">White</td> </tr> <tr> <td style="padding: 0 10px;">230 - 240 V</td> <td style="padding: 0 10px;">Black</td> </tr> </table>	Line Volt.	Connector Color	208 V	White	230 - 240 V	Black
Line Volt.	Connector Color							
208 V	White							
230 - 240 V	Black							
F04	Incoming line voltage too low.	If the line voltage is other than 208 or 230 - 240 V, consult electrician to check outlet.						
F05	Defective memory IC	If the problem persists, call service agent. The oven will operate even if Failure Code appears, just not as designed. Call service agent. If the problem occurs during memory heating, press Stop/Reset pad. Then other memory program and manual heating will be possible.						
F33-34	Defective thermistor circuit	The oven shuts off automatically. If the problem persists, call service agent.						
F44	Defective control panel	The oven shuts off automatically. If the problem persists, call service agent.						
F81-82	Defective relay circuit	If the problem persists, call service agent. The oven will operate even if Failure Code appears, just not as designed. Call service agent. Press Stop/Reset pad and try again.						
F86-87	Defective relay circuit	The oven shuts off automatically. If the problem persists, call service agent.						

Note: Above codes shown in Digital Display Window do not indicate all possible failures on the unit.

Heating and Defrosting Time Charts

TABLE OF CONTENTS

Microwave Basics	19
General Guidelines for Heating in Panasonic Microwave Oven	19
Appetizers	20
Baked Goods and Desserts	21
Breakfast	22
Fish and Seafood	24
Gravies, Sauces and Soups	25
Plated Meat and Poultry Entrees	26
Rice and Pasta	27
Sandwiches	28
Vegetables	29
Casseroles	31
Technical Specifications	32

Note: All heating times in the following charts are "approximate". We recommend you test your own recipe items and plating techniques in this oven to establish the correct heating times for your recipe items.

Maximum programmable time for each stage heating is
HI and MED power 15 minutes
DEF power 30 minutes

Example: For items that cook longer than 15 minutes on MEDIUM power, please program oven for two or three stage cooking.

For example: To program 35 minutes on MEDIUM

1st stage: Program on MEDIUM 15 minutes
2nd stage: Program on MEDIUM 15 minutes
3rd stage: Program on MEDIUM 5 minutes

TOTAL TIME on MEDIUM is 35 minutes

Heating and Defrosting Time Charts

MICROWAVE BASICS

Fundamental principles determine the success of microwave food preparation.

They include:

1. **TEMPERATURE OF FOODS** — Frozen or refrigerated food items will require longer heating times to reach a desired serving temperature than foods from room temperature.
2. **FOOD COMPONENTS** — Foods high in sugar, salt, fats and moisture content heat faster because these properties attract microwave energy. Denser foods high in protein and fiber, absorb microwave energy slower which means a lengthier heating time.
3. **BULK/VOLUME** — The greater the mass of food, the longer it takes to heat.
4. **CONTAINERS** — Ceramic, paper, china, styrofoam, glass and plastic are suitable for use in microwave ovens with the following caution.
DO NOT HEAT foods in a **SHIELD** container or

Heating foods with either high sugar or high fat content should be done. **ONLY** in high temperature-resistant containers since these foods get very hot. Using styrofoam containers for these foods will cause the styrofoam to warp. Other low temperature restaurant glass or plastic platters may crack or warp under similar conditions.

bag. Foods expand when heated and can break the container or bag.

5. **AVOID METAL** because it "bounces" the microwaves, causing uneven heating and sometimes even flashes, which may pit or mar the interior of the oven, the metal container or plate trim.
6. Heated liquids can erupt if not mixed with air. Do not heat liquids in your microwave oven without first stirring.

GENERAL GUIDELINES FOR HEATING IN A NATIONAL MICROWAVE OVEN

For specific time, see each food category for appropriate heating techniques, plus necessary preparation of foods.

HEATING FOODS FROM REFRIGERATED TEMPERATURE

Foods stored in the refrigerator (40°F) should be covered before reheating with the exception of breads, pastries or any breaded product, which should be heated uncovered to prevent sogginess.

Most conventionally prepared foods should be slightly undercooked, and held in the refrigerator, so that overcooking does not occur during microwave heating.

Cooked items, such as vegetables, may be portion plated and covered for reheating without loss of color, texture or nutritional content.

HEATING FOODS FROM ROOM TEMPERATURE

Food items such as canned entree, vegetables, etc. will require significantly less heating time than those from refrigerated temperatures.

IMPORTANT RECOMMENDATIONS

1. For best results it is recommended that foods conventionally prepared be slightly undercooked when subsequently heated in this oven.
2. **REMEMBER** that after the heating cycle has been completed, internal food temperatures continue to rise slightly in foods heated in this oven.
3. A major abuse of microwave applications is the category of breads, pastries and pies are drier than insides or fillings, they heat more slowly. Therefore, baked goods should **ONLY** be heated until the crust is warm to the touch (120°F-130°F).
4. **DO NOT OVERHEAT YOUR FOOD: 99% of all food quantity complaints of microwave heated foods can be traced to overheating.**

Heating and Defrosting Time Charts

APPETIZERS

Quantities of appetizers can be prepared conventionally in advance and refrigerated until needed. Most appetizers, with the exception of "nacho" platters and potato skins, should be heated covered. Appetizers of the same basic shape and size can be reheated together.

Most cooked appetizers heat on HIGH power, between 7 and 11 seconds per ounce depending on weight, density, and bone content. "Nacho's" need 30 to 37 seconds per ounce depending on the amount of topping.

All heating times listed in the chart are from refrigerated temperatures (40°F) except for "nacho" chips.

Item	Quantity	Instructions for Pre-preparation	Instructions for Microwave Heating	Power Setting	Approximate Times		
					NE-1257 NE-1258	NE-1757	NE-2157
BBQ Ribs	224 g (8 oz.)	Prepare conventionally, refrigerate, covered.	Place on plate, cover.	HIGH	60 sec.	45 sec.	35 sec.
Chicken Wings	140-168 g (5-6 oz.)	Prepare conventionally, refrigerate, covered.	Place on plate, cover.	HIGH	50 sec.	35 sec.	25 sec.
Chili con Queso	224 g (8 oz.)	Prepare conventionally, refrigerate, covered.	Place in small bowl, cover.	HIGH	1 min. 15 sec.	50 sec.	40 sec.
Meatballs	112-140 g (4-5 oz.)	Prepare conventionally, refrigerate, covered.	Place on plate, cover.	HIGH	50 sec.	35 sec.	25 sec.
Nachos	112 g (4 oz.)	For Best Results- Prepare when ordered or only a short time before serving to keep chips crisp.	Spread refried beans on each individual nacho. Arrange on platter. Sprinkle with Cheddar cheese. DO NOT COVER.	HIGH	50 sec.	35 sec.	25 sec.
Potato Skins	224 g (8 oz.)	Prepare skins conventionally, refrigerate, covered.	Arrange skins on platter. Sprinkle with shredded Cheddar cheese and cooked, crumbled bacon. DO NOT COVER.	HIGH	60 sec.	45 sec.	35 sec.
Rumaki	112 g (4 oz.)	Prepare conventionally, refrigerate, covered.	Place on plate, cover.	HIGH	35 sec.	25 sec.	20 sec.
Shrimp de Jonghe	112 g (4 oz.)	Prepare conventionally, refrigerate, covered.	Place on small plate, cover.	HIGH	55 sec.	40 sec.	30 sec.

Heating and Defrosting Time Charts

BAKED GOODS AND DESSERTS

Breads, pastries and pies should be heated uncovered, at HIGH power. They should be placed on absorbent material, such as a napkin or paper towel to prevent sogginess.

DO NOT OVERHEAT breads and pastries. Baked goods should only be heated until the crust feels warm to the touch (120°F-130°F).

Because crusts of breads, pastries and pies are drier than insides or fillings, they heat more slowly. After heating let rest about 1 minutes for equalization of temperature. If product is overheated, the end result will not be satisfactory.

Heating times for sweet baked goods and desserts are relatively short because of the high sugar content.

Item	Quantity	Instructions for Pre-preparation	Instructions for Microwave Heating	Power Setting	Approximate Times		
					NE-1257 NE-1258	NE-1757	NE-2157
Bread, mini-loaf white or wheat	224 g (8 oz.)	Prepare conventionally, store at room temperature.	Place on paper towel, uncovered.	HIGH	25 sec.	15 sec.	10 sec.
Coffee cake frozen	84 g (3 oz.)		Place on paper towel, uncovered.	HIGH	20 sec.	13 sec.	7 sec.
Muffins, fruit	2 ea.	Prepare conventionally or defrost, store at room temperature.	Place on paper towel, or napkin, uncovered.	HIGH	20 sec.	13 sec.	7 sec.
	6 ea.	Prepare conventionally or defrost, store at room temperature.	Place on paper towel, or napkin, uncovered.	HIGH	30 sec.	20 sec.	15 sec.
Pie, fruit	1 slice 140 g (5 oz.)	Prepare conventionally, refrigerate, covered.	Place on plate, uncovered.	HIGH	25 sec.	15 sec.	10 sec.
Rolls, hard	4 ea.	Room temperature.	Place on paper towel, uncovered. After heating, let rest 1 minute.	HIGH	25 sec.	15 sec.	10 sec.
Rolls, soft	6 ea.	Room temperature.	Place on paper towel, uncovered. After heating, let rest 1 minute.	HIGH	25 sec.	15 sec.	10 sec.
Rolls, sweet	6 ea.	Room temperature.	Place on paper towel, uncovered. After heating, let rest 1 minute.	HIGH	25 sec.	15 sec.	10 sec.

Heating and Defrosting Time Charts

BREAKFAST

All foods listed are prepared in advance and reheated at HIGH power from refrigerated temperatures (40°F).

Most breakfast foods are heated covered to retain moisture, with the exception of breads and pastries, which should be heated uncovered on absorbent material such as a napkin or paper towel to prevent sogginess. For poached eggs, pierce yolks before heating and allow eggs to stand for one minute after

cooking so pressure subsides before cutting into them.

When preparing breakfast foods conventionally, undercook slightly and immediately chill and store, covered, for later reheating.

Cured breakfast meats will reheat faster than uncured meats because salt readily absorbs microwave energy.

WARNING: Never cook or reheat eggs in the shell. They may explode when interior pressure builds up.

Item	Quantity	Instructions for Pre-preparation	Instructions for Microwave Heating	Power Setting	Approximate Times		
					NE-1257 NE-1258	NE-1757	NE-2157
Bacon	4 strips	Prepare conventionally, undercook slightly, refrigerate, covered.	Place on plate and cover.	HIGH	30 sec.	20 sec.	15 sec.
Bacon, Canadian	4 slices	Prepare conventionally, refrigerate, covered.	Place on plate and cover.	HIGH	30 sec.	20 sec.	15 sec.
Eggs, poached	2 eggs	Prepare conventionally, undercook slightly, refrigerate in salted water, covered.	Remove from water. Place on plate, pierce yolks, cover. Let rest 1 minute after heating.	HIGH	30 sec.	20 sec.	15 sec.
Eggs, scrambled	2 eggs	Prepare conventionally, undercook slightly, refrigerate, covered.	Place on plate and cover.	HIGH	30 sec.	20 sec.	15 sec.
Eggs, scrambled with bacon	2 eggs 4 strips	Prepare conventionally, undercook slightly, refrigerate, covered.	Place on plate and cover.	HIGH	35 sec.	25 sec.	20 sec.
Eggs, scrambled with sausage links	2 eggs 4 links	Prepare conventionally, undercook slightly, refrigerate, covered.	Place on plate and cover.	HIGH	45 sec.	30 sec.	20 sec.
French toast	3 slices	Prepare conventionally, refrigerate, covered.	Place toast on plate. Heat uncovered.	HIGH	35 sec.	20 sec.	15 sec.

Heating and Defrosting Time Charts

Item	Quantity	Instructions for Pre-preparation	Instructions for Microwave Heating	Power Setting	Approximate Times		
					NE-1257 NE-1258	NE-1757	NE-2157
French toast with bacon	2 slices 4 strips	Prepare conventionally, refrigerate, covered.	Place toast on plate in single layer. Cover	HIGH	45 sec.	35 sec.	30 sec.
French toast with sausage	2 slices 4 links	Prepare conventionally, refrigerate, covered.	Place toast on plate in single layer. Cover	HIGH	45 sec.	35 sec.	30 sec.
Ham steak	112 g (4 oz.)	Prepare conventionally, refrigerate, covered.	Place on plate and cover. Let rest 1 minute after heating.	HIGH	40 sec.	30 sec.	25 sec.
Hash, corned beef, canned	84 g (3 oz.)	Prepare conventionally, refrigerate, covered.	Place on plate and cover.	HIGH	40 sec.	30 sec.	25 sec.
Pancakes	4 ea.	Prepare conventionally, refrigerate, covered.	Place on plate in single layer. Heat uncovered.	HIGH	35 sec.	20 sec.	15 sec.
Pancakes with bacon	4 ea. 4 strips	Prepare conventionally, refrigerate, covered.	Place on plate in single layer. Cover.	HIGH	45 sec.	35 sec.	30 sec.
Pancakes and sausage patty	4 ea. 112 g (4 oz.)	Prepare conventionally, refrigerate, covered.	Place on plate in single layer. Cover.	HIGH	45 sec.	35 sec.	30 sec.
Potatoes, hashed brown	126 g (4½ oz.)	Prepare conventionally, refrigerate, covered.	Place on plate and heat, uncovered.	HIGH	40 sec.	30 sec.	25 sec.
Sausage links	4 links	Prepare conventionally, undercook slightly, refrigerate, covered.	Place on plate. Cover.	HIGH	40 sec.	30 sec.	25 sec.
Sausage patties	4 patties	Prepare conventionally, undercook slightly, refrigerate, covered.	Place on plate. Cover.	HIGH	35 sec.	25 sec.	20 sec.

Heating and Defrosting Time Charts

FISH AND SEAFOOD

Defrost

Fish and seafood can be defrosted and heated successfully in this microwave oven. To defrost evenly, fish should be arranged in a single layer in container and should only be thawed to the point of being flexible so it does not begin to cook at the edges.

Primary Cooking

Cooking individual portions demands close attention as well as slight undercooking. Delicate fish and shellfish should always be undercooked and should from rest after heating.

Fish/Seafood—Primary Cooking

Item	Quantity	Instructions for Pre-preparation	Instructions for Microwave Heating	Power Setting	Approximate Times		
					NE-1257 NE-1258	NE-1757	NE-2157
Robster Tail	224 g (8 oz.)	Defrost. Refrigerate, covered.	Place on plate, brush with butter and cover.	HIGH	3 min. 30 sec.	2 min. 30 sec.	1 min. 30 sec.
Perch fillets	196 g (7 oz.)	Defrost. Refrigerate, covered.	Place in microwave pan and brush with butter and herbs.	HIGH	1 min. 15 sec.	50 sec.	40 sec.
Salmon Steaks	224 g (8 oz.)	Defrost. Refrigerate, covered.	Place on plate, brush with butter and cover.	HIGH	1 min.	45 sec.	35 sec.
Scallops, Bay	140 g (5 oz.)	Defrost slightly. Refrigerate, covered.	Place in microwave pan, dot with butter and cover.	HIGH	45 sec.	35 sec.	30 sec.
Shrimp, large	168 g (6 oz.)	Defrost. Refrigerate, covered.	Place on plate and cover.	HIGH	45 sec.	35 sec.	30 sec.
Snapper, Red fillets	140 g (5 oz.)	Defrost. Refrigerate, covered.	Place on plate, brush with butter and herbs and cover.	HIGH	1 min.	45 sec.	35 sec.
Sole, stuffed with crabmeat	168 g (6 oz.)	Defrost. Refrigerate, covered.	Place on plate and cover.	HIGH	1 min. 15 sec.	50 sec.	40 sec.

Fish/Seafood, Frozen—Defrosting (To calculate time, use 15 seconds times (x) ounce)

Item	Quantity	Instructions for Pre-preparation	Instructions for Microwave Heating	Power Setting	Approximate Times		
					NE-1257 NE-1258	NE-1757	NE-2157
Lobster Tail (frozen)	224 g (8 oz.)		Place on plate and cover. After DEFROST cycle, let rest 5 min. and refrigerate or cook.	DEFROST	Use calculation Above		
Perch, fillets (frozen)	450 g (1 lb.)		Place in microwave pan and cover. Halfway through defrost, turn over and if possible, rearrange fillets. After DEFROST cycle, let rest 5 min. and refrigerate or cook.	DEFROST	Use calculation Above		
Shrimp, large (frozen)	168 g (6 oz.)		Place on plate and cover. After DEFROST cycle, refrigerate or cook.	DEFROST	Use calculation Above		

Heating and Defrosting Time Charts

GRAVIES, SAUCES AND SOUPS

Some water-based gravies, sauces and soup mixes may be prepared in large portions using this oven to heat water and thicken the blended mixes.

Refrigerated gravies, sauces and soups can be reheated quickly at HIGH and requires stirring during heating to produce an even temperature.

Gravies

Item	Quantity	Instructions for Pre-preparation	Instructions for Microwave Heating	Power Setting	Approximate Times		
					NE-1257 NE-1258	NE-1757	NE-2157
Brown gravy	1 qt.	Prepare conventionally, or heat ingredients in microwave, if recommended. Refrigerate gravy.	Place in microwave pan. Cover, stir midway and cover.	HIGH	7 min.	5 min. 30 sec.	4 min. 30 sec.
Chicken gravy	1 qt.			HIGH	5 min.	5 min.	4 min. 30 sec.

Sauces

Item	Quantity	Instructions for Pre-preparation	Instructions for Microwave Heating	Power Setting	Approximate Times		
					NE-1257 NE-1258	NE-1757	NE-2157
Au jus	1 qt.	Prepare conventionally, or heat ingredients in microwave, if recommended. Refrigerate sauce.	Place in microwave pan. Cover, stir midway through heating.	HIGH	7 min.	5 min. 30 sec.	4 min. 30 sec.
Cheese sauce	1 qt.			HIGH	8 min.	6 min. 30 sec.	5 min. 30 sec.
Espagnole (stock base)	1 qt.			HIGH	7 min.	5 min. 30 sec.	4 min. 30 sec.
Mushroom sauce	1 qt.			HIGH	7 min.	5 min. 30 sec.	4 min. 30 sec.
Tomato sauce	1 qt.			HIGH	7 min.	5 min. 30 sec.	4 min. 30 sec.
White sauce (Bechamel)	1 qt.			HIGH	7 min.	5 min. 30 sec.	4 min. 30 sec.
White sauce (stock base)	1 qt.			HIGH	7 min.	5 min. 30 sec.	4 min. 30 sec.

Soups

Item	Quantity	Instructions for Pre-preparation	Instructions for Microwave Heating	Power Setting	Approximate Times		
					NE-1257 NE-1258	NE-1757	NE-2157
Beef broth	1 qt.	Prepare conventionally, or heat ingredients in microwave, if recommended. Refrigerate soup.	Place in microwave pan. Cover, stir midway through heating.	HIGH	7 min.	5 min. 30 sec.	4 min. 30 sec.
Chicken Noodle soup	1 qt.			HIGH	7 min.	5 min. 30 sec.	4 min. 30 sec.
Clam chowder	1 qt.			HIGH	7 min.	5 min. 30 sec.	4 min. 30 sec.

Heating and Defrosting Time Charts

PLATED MEAT AND POULTRY ENTREES

Meat and poultry can be reheated successfully in this oven.

CAUTION
Pork products must be fully cooked prior to reheating.

Undercook meat slightly. Arrange meat or poultry slices in single layer, overlapping pieces as little as possible.

When appropriate, cover meats or poultry evenly with sauces.

Item	Quantity	Instructions for Pre-preparation	Instructions for Microwave Heating	Power Setting	Approximate Times		
					NE-1257 NE-1258	NE-1757	NE-2157
Beef, prime rib au jus	336 g (12 oz.)	Prepare conventionally, refrigerate, covered.	Place on plate and top meat with au jus. Cover.	HIGH	2 min.	1 min. 20 sec.	1 min.
Beef stew	224 g (8 oz.)	Prepare conventionally, refrigerate, covered.	Put in small bowl, stir midway through heating, cover.	HIGH	1 min.	45 sec.	35 sec.
Beef stroganoff with noodles	224 g (8 oz.)	Prepare conventionally, refrigerate, covered.	Place on plate and cover.	HIGH	35 sec.	45 sec.	15 sec.
Chicken, BBQ	252 g (9 oz.)	Prepare conventionally, refrigerate, covered.	Place on plate, cover. After 30 sec. of heating, spoon additional sauce evenly over chicken, if desired.	HIGH	1 min. 30 sec.	1 min.	45 sec.
Chicken, breaded, fried	224 g (8 oz.)	Prepare conventionally, refrigerate, covered.	Place on plate, uncovered.	HIGH	1 min.	45 sec.	35 sec.
Chicken, broiled	1/2 ea.	Prepare conventionally, refrigerate, covered.	Place on plate and cover.	HIGH	1 min. 30 sec.	1 min.	45 sec.
Chicken pieces, with potatoes, dressing and gravy	336 g (12 oz.)	Prepare all components conventionally, refrigerate, covered	Place on plate, depress potatoes and cover.	HIGH	3 min.	2 min.	1 min. 30 sec.
Cornish hen	1 ea. (22 oz.)	Prepare conventionally, refrigerate, covered.	Place on plate and cover.	HIGH	2 min. 30 sec.	2 min.	1 min. 30 sec.
Duck	1/2 ea.	Prepare conventionally, refrigerate, covered.	Place on plate and cover.	HIGH	3 min.	2 min.	1 min. 30 sec.
Burrito	224 g (8 oz.)	Prepare conventionally, refrigerate, covered.	Place on plate and cover.	HIGH	1 min.	45 sec.	35 sec.
Meat loaf with gravy	196 g (7 oz.)	Prepare conventionally, refrigerate, covered.	Arrange slices in single layer on plate, cover with gravy. Cover	HIGH	1 min. 10 sec.	50 sec.	45 sec.
Green peppers, stuffed	168 g (6 oz.)	Prepare conventionally, refrigerate, covered.	Place on plate and cover.	HIGH	1 min. 45 sec.	1 min. 15 sec.	50 sec.
Pork chop, stuffed	196 g (7 oz.)	Prepare conventionally, refrigerate, covered.	Place on plate and cover.	MEDIUM	2 min.	1 min. 30 sec.	1 min. 10 sec.
Ribs, short	224 g (8 oz.)	Prepare conventionally, refrigerate, covered.	Place on plate and cover.	HIGH	1 min.	45 sec.	35 sec.
Ribs, spare	448 g (16 oz.)	Prepare conventionally, refrigerate, covered.	Place on plate and cover.	HIGH	2 min.	1 min. 30 sec.	1 min. 10 sec.
Salisbury steak	196 g (7 oz.)	Prepare conventionally, refrigerate, covered.	Place on plate and cover.	MEDIUM	2 min.	1 min. 30 sec.	1 min. 10 sec.
Turkey, sliced with gravy	336 g (12 oz.)	Prepare conventionally, refrigerate, covered with gravy. Cover..	Arrange slices in single layer on plate and cover.	HIGH	1 min. 10 sec.	50 sec.	45 sec.

Heating and Defrosting Time Charts

RICE AND PASTA

For best results: reheat covered at HIGH power. Adding moisture, such as a sauce, can facilitate reheating though its not essential.

Rice and pasta dishes with cheese sauce, require more stirring than tomato-based sauces to avoid over-heating and stringiness of cheese.

Rice

Item	Quantity	Instructions for Pre-preparation	Instructions for Microwave Heating	Power Setting	Approximate Times		
					NE-1257 NE-1258	NE-1757	NE-2157
Chicken rice pilaf	112 g (4 oz.)	Prepare conventionally, undercook slightly, refrigerate, covered.	Place on plate and cover.	HIGH	50 sec.	35 sec.	25 sec.
Rice, long grain and wild rice	112 g (4 oz.)	Prepare conventionally, undercook slightly, refrigerate, covered.	Place on plate and cover.	HIGH	50 sec.	35 sec.	25 sec.

Pasta

Item	Quantity	Instructions for Pre-preparation	Instructions for Microwave Heating	Power Setting	Approximate Times		
					NE-1257 NE-1258	NE-1757	NE-2157
Lasagna	224 g (8 oz.)	Prepare conventionally, undercook slightly, refrigerate, covered.	Place on plate and cover. Cut in half, let rest 1 min. after heating.	HIGH	2 min.	1 min. 30 sec.	1 min. 30 sec.
				MED	1 min. 30 sec.	1 min.	50 sec.
Macaroni and cheese	224 g (8 oz.)	Prepare conventionally, undercook slightly, refrigerate, covered.	Place on plate and cover. Let rest 1 min. after heating.	HIGH	1 min. 30 sec.	1 min. 10 sec.	50 sec.
Noodles	112 g (4 oz.)	Prepare conventionally, undercook slightly, refrigerate, covered.	Place on plate and cover.	HIGH	45 sec.	30 sec.	20 sec.
Ravioli	168 g (6 oz.)	Prepare conventionally, undercook slightly, refrigerate, covered.	Arrange in single layer on small place and cover.	HIGH	55 sec.	40 sec.	30 sec.
	336 g (12 oz.)	Prepare conventionally, undercook slightly, refrigerate, covered.	Arrange in single layer on small place and cover.	HIGH	2 min.	1 min. 45 sec.	1 min. 10 sec.
Spaghetti with meat sauce	336 g (12 oz.)	Prepare conventionally, keeping spaghetti and sauce separate, refrigerate, covered.	Place on plate and cover with sauce. Cover.	HIGH	1 min. 50 sec.	1 min. 30 sec.	1 min. 15 sec.

Heating and Defrosting Time Charts

SANDWICHES

Preassembled sandwiches can be heated quickly and easily in this microwave oven. For best results, assemble sandwiches no more than three hours in advance. Meat fillings such as hamburgers and sausage should be precooked and preferably not be more than 1/2 inch thick.

Thin sliced means, lightly packed, allow for more even heating. place meat over bread.

All but openfaced sandwiches should be heated uncovered on absorbent material such as paper towel or napkin to prevent soginess.

Day-old, toasted breads, or breads whose formula is enriched with egg or fat are advantageous because they tend to become less soggy when heated.

Item	Quantity	Instructions for Pre-preparation	Instructions for Microwave Heating	Power Setting	Approximate Times		
					NE-1257 NE-1258	NE-1757	NE-2157
BBQ beef on bun	168 g (6 oz.)	Prepare beef conventionally, refrigerate, covered. Toast bun.	Assemble, place on paper napkin on plate, uncovered.	HIGH	60 sec.	45 sec.	35 sec.
Corned beef on rye	140 g (5 oz.)	Assemble, refrigerate, covered.	Place on paper towel, uncovered.	HIGH	60 sec.	45 sec.	35 sec.
French dip	168 g (6 oz.)	Assemble, refrigerate, covered.	Place on plate with au jus over beef and on side, uncovered.	HIGH	60 sec.	45 sec.	35 sec.
Grilled cheese	112 g (4 oz.)	Prepare conventionally, refrigerate, covered.	Place on paper towel, uncovered.	HIGH	60 sec.	45 sec.	35 sec.
Hamburger, plain with cheese	140 g (5 oz.)	Prepare burger conventionally, Toast bun. Assemble, refrigerate, covered.	Place on paper towel, uncovered.	HIGH	60 sec.	45 sec.	35 sec.
	140 g (5 oz.)			HIGH	1 min. 5 sec.	50 sec.	40 sec.
Hot dog	84 g (3 oz.)	Prepare conventionally. Toast bun. Assemble, refrigerate, covered.	Wrap loosely in plastic.	HIGH	55 sec.	40 sec.	30 sec.
Pastrami on rye	140 g (5 oz.)	Assemble, refrigerate, covered.	Place on paper towel, uncovered.	HIGH	60 sec.	45 sec.	35 sec.
Reuben	168 g (6 oz.)	Prepare conventionally, refrigerate, covered.	Place on paper towel, uncovered.	HIGH	60 sec.	45 sec.	35 sec.
Roast beef, open-face with gravy	224 g (8 oz.)	Prepare beef and gravy conventionally, refrigerate, covered. Toast bread.	Assemble, plate, cover.	HIGH	60 sec.	45 sec.	35 sec.
Sausage, Italian on sub roll	154 g (5 1/2 oz.)	Prepare sausage conventionally. Toast roll. Assemble, refrigerate, covered.	Place on paper towel, uncovered.	HIGH	60 sec.	45 sec.	35 sec.
Turkey, open-face with gravy	224 g (8 oz.)	Prepare turkey and gravy conventionally, refrigerate, covered. Toast bread.	Assemble, plate, cover.	HIGH	60 sec.	45 sec.	35 sec.

Heating and Defrosting Time Charts

VEGETABLES

Most vegetables, small and bulk portions, defrost, heat, and cook very successfully in the microwave, retaining fresh color and texture as well as nutritional value. The thicker and more fibrous the vegetable, the longer the cooking time. (ie. Root vegetables)

Frozen vegetables can be defrosted and heated in one step. One to two tablespoons of water should be added to frozen vegetables.

Icy sections should be broken up during heating for even temperature distribution.

Canned vegetables can be heated using HIGH in approximately 1 minute per pound.

Most fresh vegetables are prepared with a small amount of cooking liquid such as water.

Vegetables, Frozen—Defrosting and Heating

Item	Quantity	Instructions for Pre-preparation	Instructions for Microwave Heating	Power Setting	Approximate Times		
					NE-1257 NE-1258	NE-1757	NE-2157
Beans, green	4 lb.	NONE	Place in a microwave safe 6" half pan. Add one to two tablespoons of water. Cover with lid. Let stand, covered, 2 minutes.	HIGH	4 min./lb.	3 min./lb.	2min./lb.
	6 lb.	NONE		HIGH			
Cauliflower	4 lb.	NONE		HIGH			
	6 lb.	NONE		HIGH			
Broccoli	4 lb.	NONE		HIGH			
Carrots, sliced	6 lb.	NONE		HIGH			

Heating and Defrosting Time Charts

Vegetable, Fresh—Heating

Item	Quantity	Instructions for Pre-preparation	Instructions for Microwave Heating	Power Setting	Approximate Times			
					NE-1257 NE-1258	NE-1757	NE-2157	
Carrots & other root vegetables	(cook)	4 lb.	Peel carrots; cut into 1/8" slices.	Wash vegetables well. Cut into uniform size pieces. Place in microwave safe Cambro 4" half pan. Cover with lid. Stir midway through heating. After heating, let stand, covered, 2 minutes.	HIGH	8 min.	6 min.	5 min.
		5 lb.			HIGH	10 min.	7 min. 30 sec.	6 min. 30 sec.
		6 lb.			HIGH	12 min.	9 min.	8 min.
		7 lb.			HIGH	13 min. 30 sec.	10 min. 30 sec.	9 min. 30 sec.
	(blanch)	4 lb.	Peel carrots; cut into 1/8" slices.	Wash vegetables well. Cut into uniform size pieces. Place in microwave safe Cambro 4" half pan. Add 3 to 4 tablespoons of water. Stir midway through heating. After heating, let stand, covered, 2 minutes.	HIGH	6 min.	4 min.	3 min.
		5 lb.			HIGH	8 min. 50 sec.	5 min. 30 sec.	4 min. 30 sec.
		6 lb.			HIGH	10 min.	7 min.	6 min.
		7 lb.			HIGH	11 min. 30 sec.	8 min. 30 sec.	7 min. 30 sec.

Vegetable, Fresh—Primary Cooking

Item	Quantity	Instructions for Pre-preparation	Instructions for Microwave Heating	Power Setting	Approximate Times		
					NE-1257 NE-1258	NE-1757	NE-2157
Broccoli	3 lb.	Rinse broccoli. Cut into spears.	Place in a microwave safe Cambro 6" half pan. Add 2 tablespoons of water. Cover. After cooking, let stand, covered, 2 minutes.	HIGH	10 min.	7 min.	5 min.
Baked Potatoes	8 pcs. (100 ct.)		Place in a microwave safe Cambro 6" half pan. Add 2 tablespoons of water. Cover. After cooking, let stand, covered, 2 minutes.	HIGH	8 min.	7 min.	6 min.
Refried beans	6 lb. 6 oz. (#10 can)		Place in a microwave safe Cambro 6" half pan. Cover with lid. After cooking, let stand 2 minutes.	HIGH	8 min.	6 min. 30 sec.	5 min.

Heating and Defrosting Time Charts

CASSEROLES

Food-Service casseroles can be cooked successfully in this microwave oven. For best results, follow instructions below.

Preparation

Remove all casseroles from their foil baking trays, while still frozen and place in a microwave safe 4-inch half pan. Place in refrigerator and thaw for about 30 minutes per ounce.

Let stand 15 minutes before serving.

Casseroles, Frozen—Heating

Item	Quantity	Instructions for Pre-preparation	Instructions for Microwave Heating	Power Setting	Approximate Times		
					NE-1257 NE-1258	NE-1757	NE-2157
Vegetable Lasagna	Caluculate min./lb.	Place in 4" half pan. Thaw in refrigerator for approx. 4 days.	Cover with lid. Let stand 15 minutes before serving.	1st Stage HIGH	2 min. 30 sec. per lb.	1 min. 30 sec. per lb.	1 min. per lb.
				2nd Stage MED	2 min. 30 sec. per lb.	1 min. 30 sec. per lb.	1 min. per lb.
Spinach Souffle	Caluculate min./lb.	Place in 4" half pan. Thaw in refrigerator for approx. 2 days..	Cover with lid. Let stand 15 minutes before serving.	1st Stage MED	2 min. 30 sec. per lb.	1 min. 30 sec. per lb.	1 min. per lb.
				2nd Stage HIGH	2 min. 30 sec. per lb.	1 min. 30 sec. per lb.	1 min. per lb.
Deep Dish Cherry Crisp	Caluculate min./lb.	Place in 4" half pan. Thaw in refrigerator.	Sprinkle with 2 tablespoons of sugar.	HIGH	2 min. 30 sec. per lb.	1 min. 30 sec. per lb.	1 min. per lb.
Macaroni and Cheese	Caluculate min./lb.	Place in 4" half pan. Thaw in refrigerator for approx. 2 days.	Cover with lid. Stir after cooking.	HIGH	2 min. 30 sec. per lb.	1 min. 30 sec. per lb.	1 min. per lb.
Burritos	Caluculate min./lb.	Place on paper towel.	Heat covered.	HIGH	2 min. 30 sec. per lb.	1 min. 30 sec. per lb.	1 min. per lb.

Instructions for all casseroles & large items (4 lbs. or more) that are ordinarily baked:

- 1) Defrost (see defrost method on page 29).
- 2) Heat: From refrigerated temperatures (< 40°F and > 32°F)
 - Stage 1 = High time per lb.
 - Stage 2 = Medium time per lb.

Technical Specifications

	NE-1257/NE-1258	NE-1757	NE-2157
Power Source	120 V, 60 Hz., single phase	208/230 V, 60 Hz., single phase	
Required Power (Voltage)	17.7 A (120 V)	14.3 A (208 V) 13.3 A (230 V)	16.6 A (208 V) 15.3 A (230 V)
Receptacle Required	20 AMP NEMA #5-20R	15 AMP NEMA #6-15R 20 AMP NEMA #6-20R	20 AMP NEMA #6-20R
Output	HI: 1200 W* MED: 600 W DEF: 340 W	HI: 1700 W* MED: 850 W DEF: 340 W	HI: 2100 W* MED: 1050 W DEF: 340 W
Frequency	2450 MHz	2450 MHz	2450 MHz
Outer dimensions (W x D x H)	16 ⁵ / ₈ " x 20" x 13 ¹ / ₄ " (422 mm x 508 mm x 337 mm)		
Cavity dimensions (W x D x H)	13" x 12 ³ / ₃₂ " x 6 ⁷ / ₈ " (330 mm x 310 mm x 175 mm)		
Net weight (approx.)	56 lbs. (25.4 kg)	60 lbs. (27.2 kg)	66 lbs. (29.9 kg)

*IEC 705-88 Test Procedure
Specifications subject to change without notice.

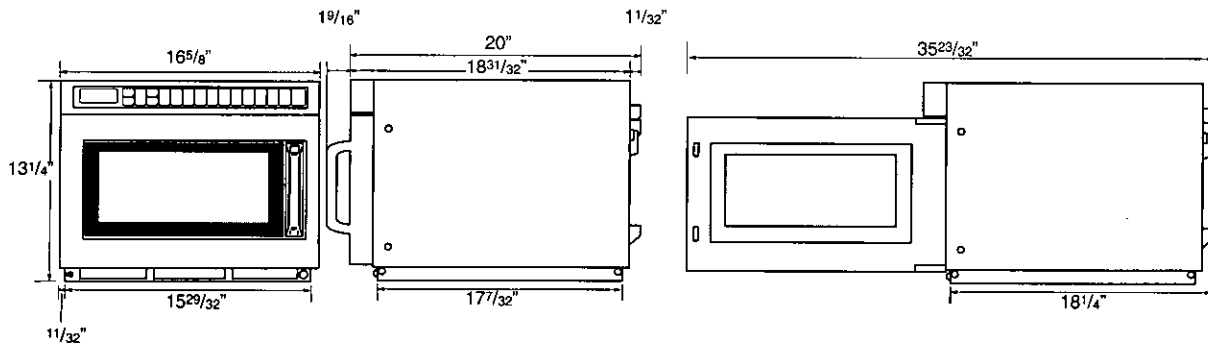

Panasonic®

www.panasonic.com/cmo
**PANASONIC HOME AND COMMERCIAL
 PRODUCTS COMPANY, DIVISION OF
 MITSUBISHI ELECTRIC CORPORATION
 OF AMERICA**

One Panasonic Way 4A-4
 Secaucus, NJ 07094
 Or Call (201) 348-5377

A00033960AP
 F0900-0
 Printed in Japan