

# Panasonic®

## *Operating Instructions*

*Microwave / Convection Oven*

*Models NN-9804 / NN-9854 / NN-9854P*

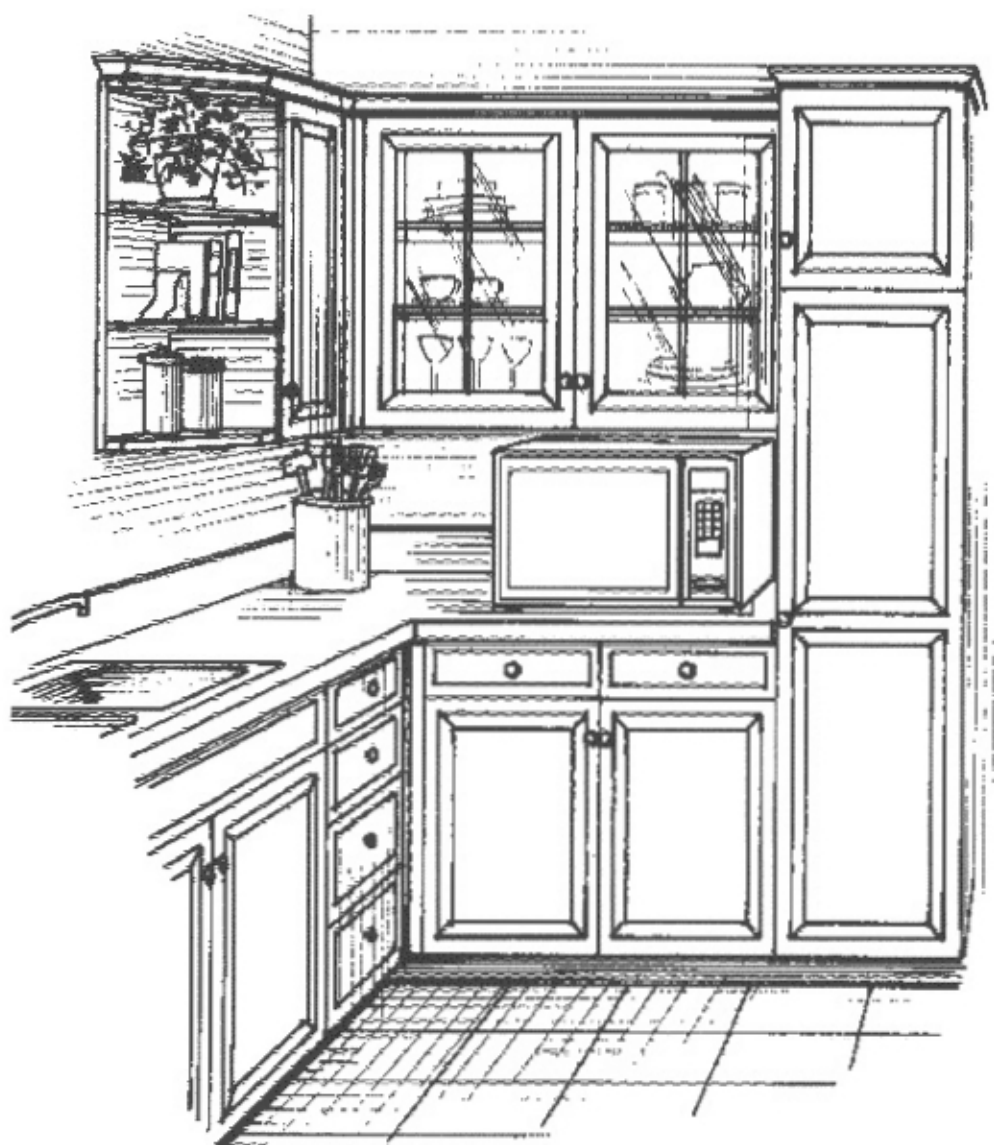

*Before operating this oven, please read these instructions completely.  
Antes de operar este producto, lea este instructivo en su totalidad.  
La referencia rápida en español puede ser encontrada en la páginas 26-39.  
(Spanish quick reference can be found on pages 26-39.)*

## PRECAUTIONS TO AVOID POSSIBLE EXPOSURE TO EXCESSIVE MICROWAVE ENERGY

- (a) Do not attempt to operate this oven with the door open since open-door operation can result in harmful exposure to microwave energy. It is important not to defeat or tamper with the safety interlocks.
- (b) Do not place any object between the oven front face and the door, or allow soil or cleaner residue to accumulate on sealing surfaces.
- (c) Do not operate the oven if it is damaged. It is particularly important that the oven door close properly and that there is no damage to the:
- (1) door (bent)
  - (2) hinges and latches (broken or loosened)
  - (3) door seals and sealing surfaces.
- (d) The oven should not be adjusted or repaired by anyone except properly qualified service personnel.

### EXAMINE YOUR OVEN

Unpack oven, remove all packing material.

Examine the oven for any damage such as dents, broken door latches or cracks in the door. Check that none of the accessories are missing, by following the list below.

**Roller Ring**

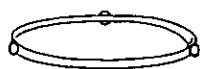

Place the Roller Ring correctly on the oven floor.

**Oven Rack**

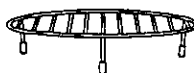

Oven Rack should be used for Bake and Broil cooking.

**Ceramic Tray**



Place the Ceramic Tray exactly on Roller Ring. Always use Roller Ring and Ceramic Tray in proper position.

**Operating Instructions**

**Cookbook**

Notify dealer immediately if oven is damaged. **Do NOT** install if oven is damaged.

The serial number of this product may be found on the right side of the oven door opening. You should note the model number and the serial number of this oven in the space provided and retain this book as a permanent record of your purchase for future reference.

Model No. \_\_\_\_\_

Serial No. \_\_\_\_\_

Date of Purchase \_\_\_\_\_

# CONTENTS

## Before Operating

Important Safety Instructions . . . . .	4
Installation and Grounding Instructions . . . . .	5-6
Practical Hints . . . . .	6-7
Feature Diagram . . . . .	8
Cooking Modes . . . . .	8-9
Control Panel . . . . .	9

## Operation & Hints

Let's Start to Use Your Oven! . . . . .	10
Quick Guide to Operation . . . . .	11
To Set Clock . . . . .	12
Operation Guide on the Screen . . . . .	12
Child Safety Lock . . . . .	12
To Reheat using Micro Power and Time Setting . . . . .	13
using Sensor Reheat Pad . . . . .	18
To Defrost using Micro Power and Time Setting . . . . .	13
using Auto Defrost Pad . . . . .	17
To Cook using Micro Power and Time Setting . . . . .	13
on Bake using Time Setting . . . . .	14
on Broil using Time Setting . . . . .	15
on Combination using Time setting . . . . .	16
using One Touch Cooking Pads . . . . .	18-21
using Popcorn Pad . . . . .	22
using Quick Min Pad . . . . .	22
To Set Timer . . . . .	23
To Set Stand Time . . . . .	23
To Set Delay Start . . . . .	23

## Maintenance

Before Requesting Service . . . . .	24
Care of Your Microwave Oven . . . . .	25
Technical Specifications . . . . .	40

## Referencia Rápida (Spanish Quick Reference)

Diagrama de Característica . . . . .	26
Modos de Cocción . . . . .	26
Panel de Controles . . . . .	27
Procedimiento de Operación . . . . .	28
Selección de Potencia y Tiempo . . . . .	29
Pulsador de Quick Min . . . . .	29
Pulsadores de Palomitas de Maíz . . . . .	29
Hornear . . . . .	30
Parrilla . . . . .	31
Combinación . . . . .	32
Auto Descongelamiento . . . . .	33
Sensor de Recalentamiento Automático . . . . .	33
Sensor de Cocción Automático . . . . .	34
Cocción Automático por Peso (Combinación) . . . . .	36
Hornear Automático . . . . .	37
Temporizador . . . . .	38
Cuidados de Su Horno de Microondas . . . . .	39
Antes de Acudir a Servicio . . . . .	39

# IMPORTANT SAFETY INSTRUCTIONS

When using electrical appliances, basic safety precautions should be followed, including the following:

**WARNING** — To reduce the risk of burns, electric shock, fire, injury to persons or exposure to excessive microwave energy:

1. Read all instructions before using the appliance.
2. Read and follow the specific "PRECAUTIONS TO AVOID POSSIBLE EXPOSURE TO EXCESSIVE MICROWAVE ENERGY," found on page 2.
3. This appliance must be grounded. Connect only to properly grounded outlet. See "GROUNDING INSTRUCTIONS" found on page 3.
4. Install or locate this appliance only in accordance with the installation instructions found on page 5.
5. Do not cover or block any openings on this appliance.
6. Do not store or use this appliance outdoors. Do not use this product near water — for example, near a kitchen sink, in a wet basement, or near a swimming pool, and the like.
7. Use this appliance only for its intended use as described in this manual. Do not use corrosive chemicals or vapors in this appliance. This type of oven is specifically designed to heat, or cook food. It is not designed for industrial or laboratory use.
8. When cleaning surfaces of door and oven that come together on closing the door, use only mild, non-abrasive soaps or detergents applied with a sponge or soft cloth.
9. As with any appliance, close supervision is necessary when used by children.
10. Do not operate this appliance if it has a damaged cord or plug, if it is not working properly, or if it has been damaged or dropped.
11. Do not immerse cord or plug in water.
12. Keep cord away from heated surfaces.
13. Do not let cord hang over edge of table or counter.
14. This appliance should be serviced only by qualified service personnel. Contact the nearest authorized service facility for examination, repair or adjustment.
15. Some products such as whole eggs and sealed containers — for example, closed glass jars — may explode and should not be heated in this oven.
16. To reduce the risk of fire in the oven cavity:
  - (a) Do not overcook food. Carefully attend appliance if paper, plastic, or other combustible materials are placed inside the oven to facilitate cooking.
  - (b) Remove wire twist-ties from paper or plastic bags before placing bag in oven.
  - (c) If materials inside the oven should ignite, keep oven door closed, turn oven off, and disconnect the power cord, or shut off power at the fuse or circuit breaker panel.
  - (d) Do not use the cavity for storage purposes. Do not leave paper products, cooking utensils, or food in the cavity when not in use.

17. Use extreme caution when removing the Ceramic Tray right after cooking when it is hot.
18. To avoid the possible risk of a burn, the appliance must not be used in areas such as island-type countertops where the rear surfaces would be exposed to user contact and the appliance must be placed more than 3 feet (85 cm) above the floor.

## General Use

1. Do NOT tamper with or make any adjustments or repairs to door, control panel housing, safety interlock switches or any other part of the oven. Do NOT remove outer panel from oven. Repairs should only be done by a qualified service person.

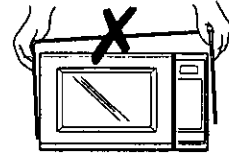

2. Do NOT operate the oven empty. The microwave energy will reflect continuously throughout the oven if food or water is not present to absorb energy. This could damage the oven and result in the danger of a fire.

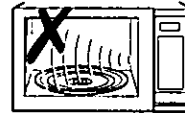

3. Do NOT use this oven to heat chemicals or other non-food products. Do NOT clean this oven with any product that is labeled as containing corrosive chemicals. The heating of corrosive chemicals in this oven can cause radiation leaks.
4. Do NOT dry clothes, newspapers or other materials in oven. They may catch fire.
5. Do NOT use recycled paper products unless the paper product is labelled as safe for microwave oven use. Recycled paper products may contain impurities which may cause sparks and/or fires when used.
6. Do NOT use newspapers or paper bags for cooking. Fire can result.
7. Do NOT hit or strike control panel. Damage to controls may occur. Fire can result.
8. POT HOLDERS may be needed when cooking. Heat is transferred from the hot food to the cooking container and from the cooking container to the Ceramic Tray. Ceramic Tray can be very hot after removing cooking container from oven.
9. Do NOT store flammable materials next to, on top of, or in the oven. These could be fire hazards.
10. Before using the BAKE, COMBINATION or BROIL functions for the first time, operate the oven without food on BROIL for 20 minutes. This will allow the oil that is used for rust protection to be burned off.
11. Door will get hot during BAKE, COMBINATION and BROIL. Please handle door carefully.

## SAVE THESE INSTRUCTIONS

For proper use of your oven read remaining safety cautions and operating instructions.

# Installation Instructions

## Placement of Oven

**Do NOT** place oven near water — for example, near a kitchen sink, in a wet basement or near a swimming pool, and the like.

**Do NOT** place oven near a hot damp surface such as a gas or electric range.

Operation of the microwave oven may cause interference to your radio, TV or similar equipment. Place the radio, TV, etc as far away as possible from the microwave oven.

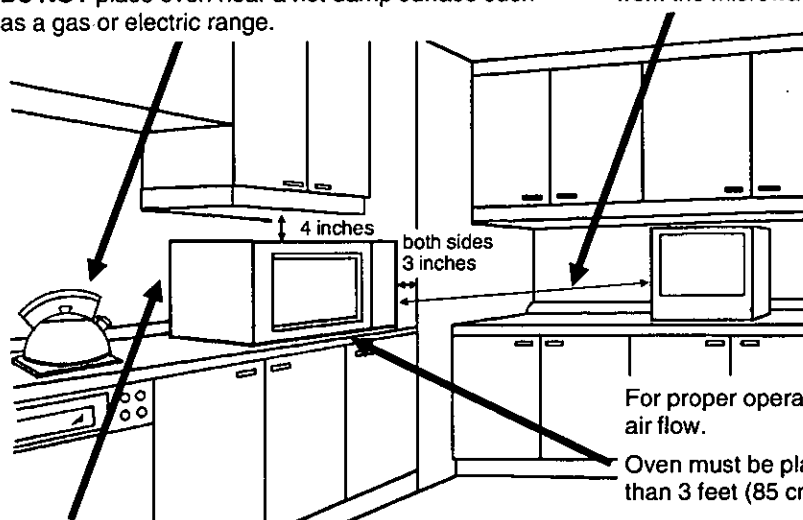

**Do NOT** block air vents.

If they are blocked during operation, the oven may overheat. If the oven overheats, a thermal safety device will turn the oven off. The oven will remain inoperable until it has cooled.

**Do NOT** operate oven when room humidity is too high. This oven was manufactured for household use only.

If desired, this oven may be built into a wall cabinet by using the proper trim kit, which may be purchased from a local Panasonic dealer. If the proper trim kit is not used, malfunction of the oven may occur. Follow all installation instructions packed with kit. See page 40 for Technical Specifications.

For proper operation, the oven must have sufficient air flow.

Oven must be placed on a flat, stable surface, more than 3 feet (85 cm) above the floor.

Plug into at least a 15 AMP 120 VOLT, 60 Hz (50/60 Hz for NN-9854P only) grounded outlet. Keep cord away from heated surface. Do not immerse cord or plug in water. Do not let cord hang over edge of table surfaces.

Before Operating

## GROUNDING INSTRUCTIONS

### Grounding Instructions

This appliance must be grounded. In the event of an electrical short circuit, grounding reduces the risk of electric shock by providing an escape wire for the electric current. This appliance is equipped with a cord having a grounding wire with a grounding plug. The plug must be plugged into an outlet that is properly installed and grounded.

**WARNING**-Improper use of the grounding plug can result in a risk of electric shock.

Consult a qualified electrician or service person if the grounding instructions are not completely understood, or if doubt exists as to whether the appliance is properly grounded.

If it is necessary to use an extension cord, use only a three wire extension cord that has a three blade grounding plug, and a three slot receptacle that will accept the plug on the appliance. The marked rating of the extension cord should be equal to or greater than the electrical rating of the appliance.

### Power Supply

1. A short power-supply cord is provided to reduce the risks resulting from becoming entangled in or tripping over a longer cord.
2. Longer cord sets or extension cords are available and may be used if care is exercised in their use.
3. If a long cord or extension cord is used, (1) the marked electrical rating of the cord set or extension cord should be at least as great as the electrical rating of the appliance, (2) the extension cord must be a grounding-type 3-wire cord, and (3) the longer cord should be arranged so that it will not drape over the countertop or tabletop where it can be pulled on by children or tripped over accidentally.

## Wiring Requirements

- 1 The oven must be on a **SEPARATE CIRCUIT**. No other appliance should share the circuit with the microwave oven. If it does, the branch circuit fuse may blow, the circuit breaker may trip or the food may cook slower than the times recommended in the cookbook.
- 2 The **VOLTAGE** used must be the same as specified on this microwave oven (120V). Using a higher voltage is dangerous and may result in a fire or other accident causing oven damage. Using a lower voltage will cause slow cooking. Panasonic is **NOT** responsible for damage resulting from the use of the oven with other than specified voltage.
- 3 The oven must be plugged into at least a 15 AMP 120 VOLT, 60 Hz (50/60 Hz for NN-9854P) only **GROUNDING OUTLET**.

Where a standard two-prong outlet is encountered, it is the personal responsibility and obligation of the consumer to have it replaced with a properly grounded three-prong outlet.

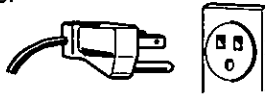

- 4 A **TEMPORARY CONNECTION** with a two-prong adaptor may be made where **LOCAL CODES PERMIT** it. Unless the cover screw is grounded through the house wiring, attaching the adaptor grounding plate to the cover screw will not ground the oven. If there is any doubt that the cover screw is grounded, have it checked by an electrician.



## Radio Interference

- 1 Operation of the microwave oven may cause interference to your radio, TV or similar equipment.
- 2 When there is interference, it may be reduced or eliminated by taking the following measures:
  - a Clean door and sealing surfaces of the oven. (See Care of Your Microwave Oven found on page 25)
  - b Place the radio, TV, etc. away from the microwave oven as far as possible.
  - c Use a properly installed antenna to obtain stronger signal reception.

## Follow These Safety Precautions When Cooking in Your Oven

### 1) HOME CANNING/DRYING FOODS/SMALL QUANTITIES OF FOODS

- Do not use your oven for home canning or the heating of any closed jar. Pressure will build up and the jar may explode. Your oven cannot maintain the food at the proper canning temperature. Improperly canned food may spoil and be dangerous to consume.
- Small quantities of food or foods with low moisture content can dry out, burn or catch on fire.
- Do not dry meats, herbs, fruits or vegetables in your oven.

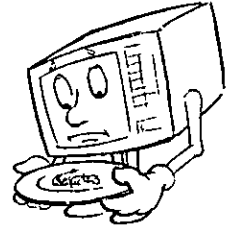

### IMPORTANT

Proper cooking depends on time set and weight of food. If you use a smaller portion than recommended and cook at the time for the recommended portion, fire can result. If a fire occurs, turn oven off and leave oven door closed. Disconnect the power cord or shut off power at the fuse or circuit breaker panel.

### 2) POPCORN

Popcorn must be popped in a microwave oven corn popper. Microwave popcorn which pops in its own package is also available. Follow popcorn manufacturers' directions and use a brand suitable for the wattage of your microwave oven. Never leave oven unattended when popping popcorn.

### CAUTION

When using pre-packaged microwave popcorn, follow recommended package instructions. Check package weight before using the popcorn pad. Set the oven for the weight of the popcorn package (see page 22). If these instructions are not followed, the popcorn may not pop adequately or may ignite and cause a fire.

### 3) DEEP FAT FRYING

- Do not attempt to deep fat fry in your microwave oven. Cooking oils may burst into flames and may cause damage to the oven and perhaps result in burns. Microwave utensils may not be able to withstand the temperature of the hot oil, and could shatter.

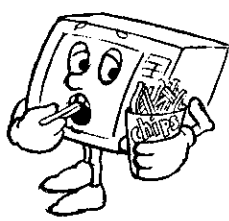

### 4) EGGS

- Do not heat eggs in their shell in a microwave oven. Pressure will build up and the eggs will explode.

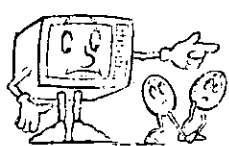

### 5) FOODS WITH NONPOROUS SKINS

- Potatoes, apples, egg yolks, whole squash and sausages are examples of foods with nonporous skins. These types of foods must be pierced before Microwave or Combination cooking to prevent their bursting.

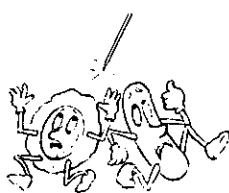

- Use fresh potatoes for baking and cook until just done. Overcooking causes dehydration and may cause a fire. Use recommended weights or fire may occur.

### 6) LIQUIDS

- Heated liquids can erupt if not mixed with air. Do not heat liquids in your microwave oven without first stirring.

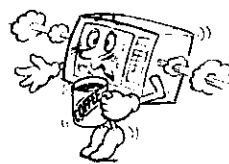

### 7) CERAMIC TRAY/COOKING UTENSILS/FOIL

- Cooking utensils get hot during cooking. Use potholders when removing utensils from the oven or when removing lids or plastic wrap covers from cooking utensils to avoid burns.
- The ceramic tray will get hot during cooking. It should be allowed to cool before handling or before paper products, such as paper plates or microwave popcorn bags, are placed in the oven for microwave cooking.

- When using foil, skewers, warming rack or utensils made of metal in the oven for Microwave or Combination cooking, allow at least 1-inch (3 cm) of space between metal material and interior oven walls. If arcing occurs (sparking) remove metal material (skewers etc.) and/or transfer to a non-metallic container.
- Dishes with metallic trim should not be used during Microwave or Combination cooking, as arcing may occur.

### 8) PAPER TOWELS/CLOTHS

- Do not use paper towels or cloths which contain a synthetic fiber woven into them. The synthetic fiber may cause the towel to ignite.
- Do not use paper bags or recycled paper products in the microwave oven.

### 9) BROWNING DISHES/OVEN COOKING BAGS

- Browning dishes or grills are designed for microwave cooking only. Always follow instructions provided by the manufacturer. Do not preheat browning dish more than 8 minutes.
- If an oven cooking bag is used for Microwave cooking, prepare according to package directions. Do not use a wire twist-tie to close bag.

### 10) THERMOMETERS

- Do not use a conventional meat thermometer for Microwave or Combination cooking. Arcing may occur.
- Do not use a Microwave meat thermometer for Combination cooking, Baking or Broiling. It may melt.

### 11) GENERAL OVEN USAGE GUIDELINES/ OVEN DOOR

- The oven door and the interior oven walls will get hot during Combination, Bake and Broil.
- Do not use the oven for any reason other than the preparation of food.
- Do not leave oven unattended while in use.

# Feature Diagram

## Ceramic Tray

1. Do not operate the oven without the Roller Ring and Ceramic Tray in place.
2. Only use the Ceramic Tray specifically designed for this oven. Do not substitute with any other tray.
3. If Ceramic Tray is hot, allow to cool before cleaning or placing in water.
4. **Do not** cook directly on Ceramic Tray. Always place food in a microwave-safe dish, or on a rack set in a microwave-safe dish.
5. If food or utensil on Ceramic Tray touches oven walls, causing the tray to stop moving, the tray will automatically rotate in the opposite direction. This is normal.
6. Ceramic tray can rotate in either direction.

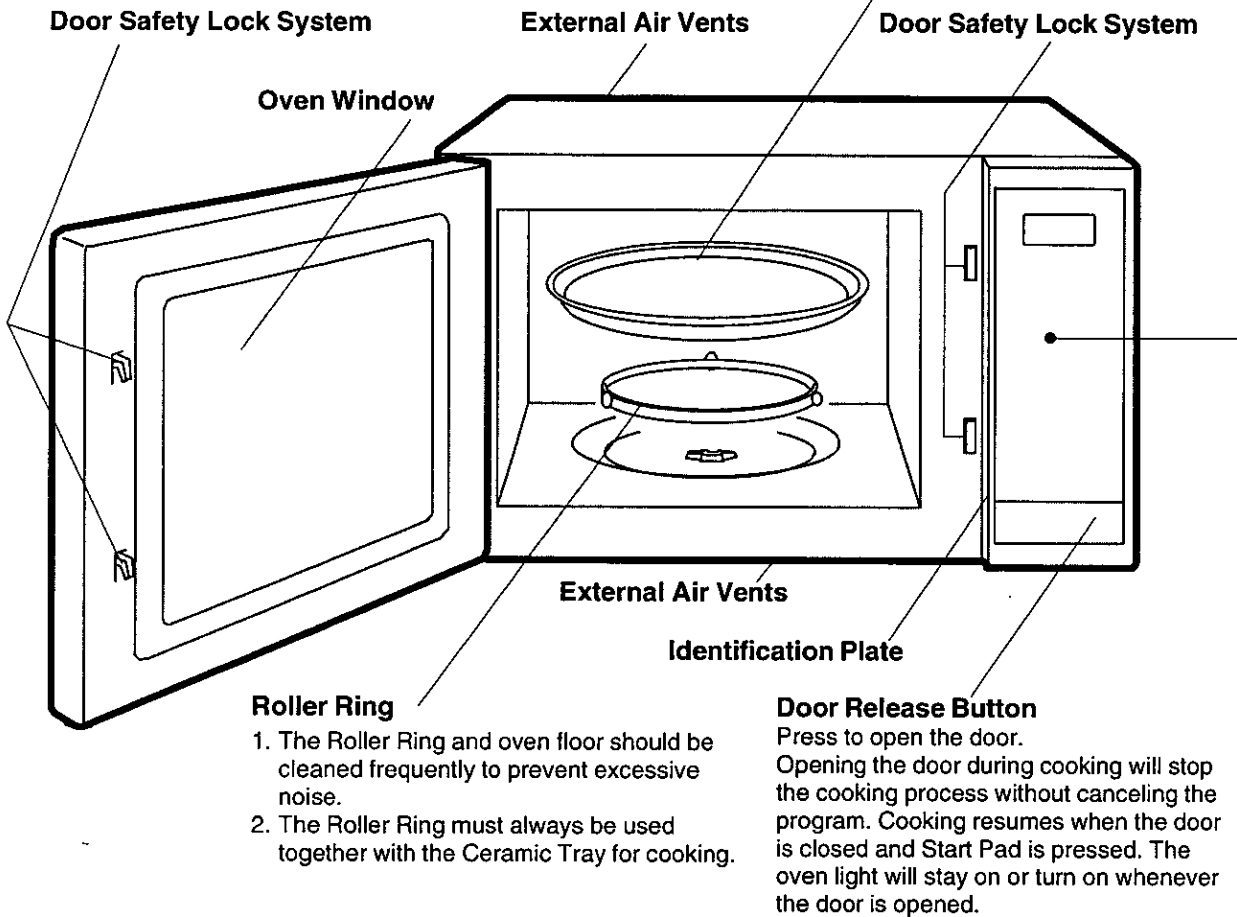

# Cooking Mode; Heating Source

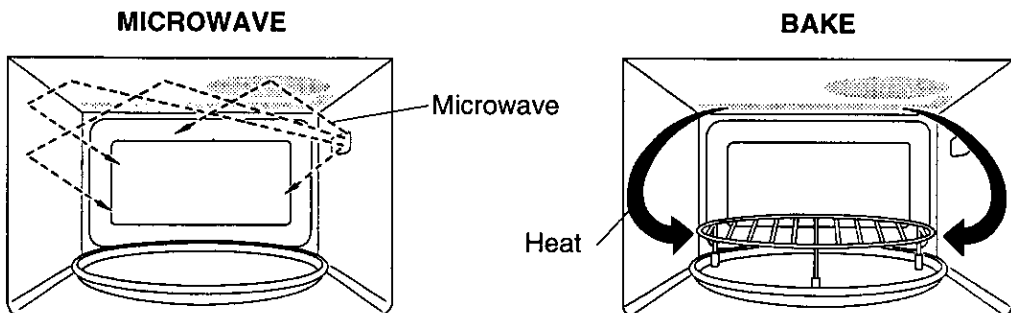



# Control Panel

## Display Window

During microwave/heater operation, the indication rotates at the left side of the display window.

\* Your Control Panel design might be different from the illustration in this book.

**Micro Power Pad** (☛ page 13)

**Bake Pad** (☛ page 14)

**Broil Pad** (☛ page 15)

**Combination Pad** (☛ page 16)

**Auto Defrost Pad** (☛ page 17)

**Number Pads**

**Timer Pad** (☛ page 23)

**Clock Pad** (☛ page 12)

**Popcorn Pad** (☛ page 22)

**Quick Min Pad** (☛ page 22)

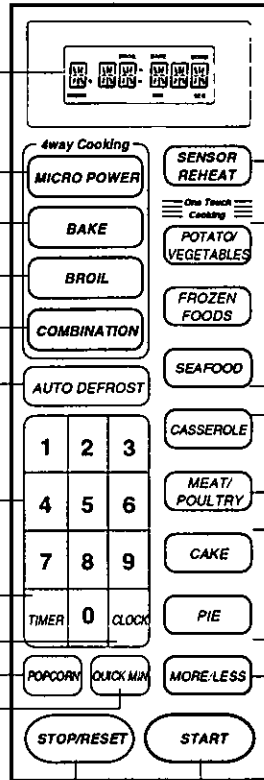

**Sensor Reheat Pad** (☛ page 18)

« ONE TOUCH COOKING »

**Sensor Cook by Microwave**  
(☛ page 18)

**Sensor Cook by Combination**  
(☛ page 18)

**Weight Cook by Combination**  
(☛ page 20)

**Auto Bake** (☛ page 21)

**More / Less Pad** (☛ page 18)

## Stop/Reset Pad

**Before cooking:** One tap clears your instruction.  
**During cooking:** One tap temporarily stops the cooking process. Another tap cancels all your instructions and time of day or colon appears in the display window.

## Prompters:

When pads are pressed, a beep sound is heard and the corresponding letter or word(s) appear and roll across the display. If a pad is pressed and no beep is heard, the unit has not or cannot accept the instruction. Words will automatically appear to prompt the user performing the next step. It is not necessary to wait for the words to appear before pressing pads for the next step. A two beep sound is heard between stages. At the end of any complete program, the oven will beep five times.

## Start Pad

One tap allows oven to begin functioning. If door is opened or Stop/Reset Pad is pressed once during oven operation, Start Pad must again be pressed to restart oven.

## BROIL

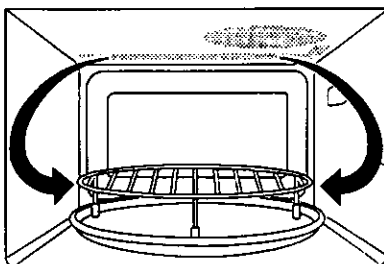

## COMBINATION

Microwave

Heat

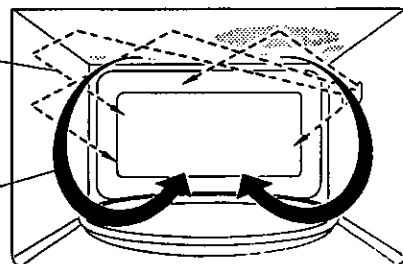

# Let's Start to Use Your Oven !

## 3 Select Power Level

e.g. MEDIUM Power — Press Micro Power four times (see page 13 for chart)

## 1 Plug in

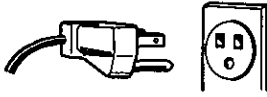

Plug into a properly grounded electrical outlet. "WELCOME" rolls across the display window.

### Conversion:

The display automatically appears in English with weight/temperature measurement in imperial.

If you wish to use Spanish or French and metric system, press Start Pad until the desired pair appears on the display window. The conversion should be programmed directly after plugging the oven in.

Press Start	Convert into
—	English / lb / °F
once	English / kg / °C
twice	Français / kg / °C
3 times	Español / kg / °C
4 times	Español / lb / °F

## 4 Set Cooking Time

e.g. 1 minute 30 seconds

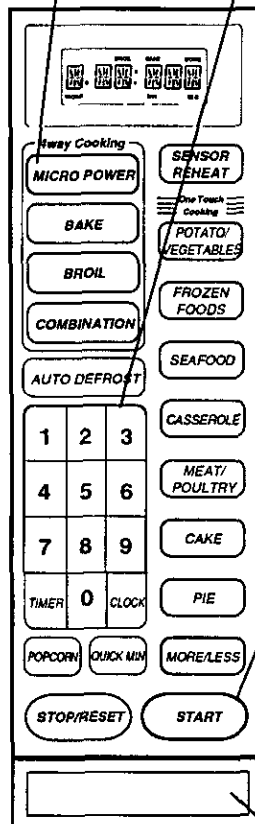
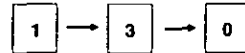



## 5 Press Start

► The time in the display window will count down.

## 2 Place a cup of water in the oven

Open the door and place a cup of water on the Ceramic Tray in the oven. Then close the door.

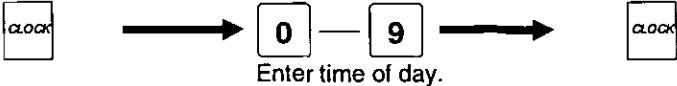
# Quick Guide to Operation

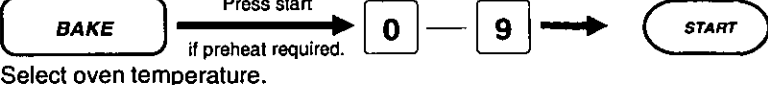
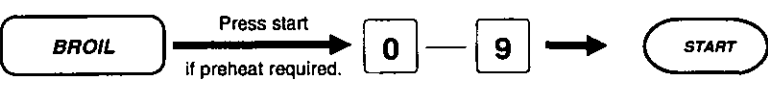
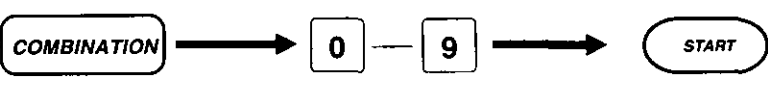
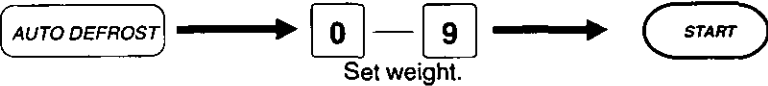
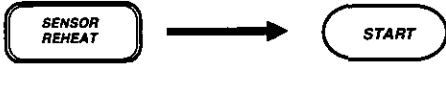
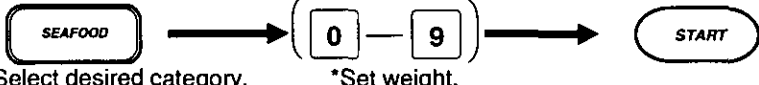
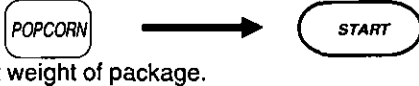
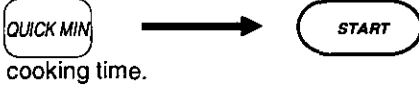
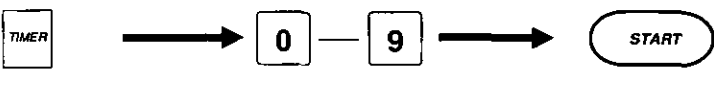
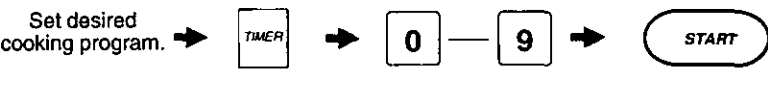
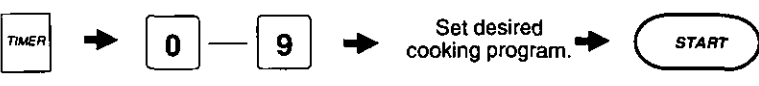
Feature	How to Operate
To Set Clock (☛page 12)	
Micro Power and Time Setting (☛page 13)	
To Bake (☛page 14)	
To Broil (☛page 15)	
To Cook on Combination (☛page 16)	
To Defrost using "Auto Defrost" (☛page 17)	
To Reheat using "Sensor Reheat" (☛page 18)	
To Cook using "One Touch Cooking" (☛pages 18-21)	<p>e.g.</p> 
To Cook using "Popcorn" (☛page 22)	
To Use "Quick Min" (☛page 22)	
To Use as a Kitchen Timer (☛page 23)	
To Set Stand Time (☛page 23)	
To Set Delay Start (☛page 23)	

\* Refer to the operation guide on the screen.

# Clock Setting

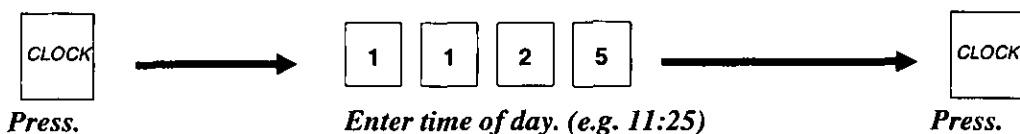

**NOTE:**

- 1. You can use the oven without setting the clock.
- 2. There is no a.m. or p.m. settings. Clock is a 12 hour display.
- 3. To reset time of day, repeat the steps above.
- 4. The clock will retain time setting only when plugged into power source.

# Operation Guide in the Display

To assist you in programming your oven, an operation guide will appear in the display window. When you become familiar with your oven, the operation guide can be turned off.

## To Turn Off:

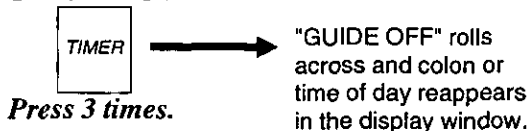

## To Turn On:

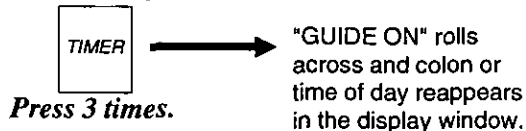

# Child Safety Lock

This feature allows the prevention of use by children (not including door mechanism). You can set Child Lock when the display shows a colon or time of day.

## To Set:



## To Cancel:

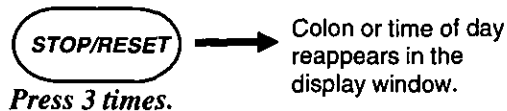

# Micro Power & Time Setting

Use of Accessory:

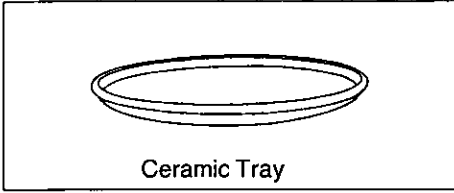

## 1 Select Power Level

Press	Power Level	% Power
once	HIGH	100 %
twice	DEFROST	30 %
3 times	MEDIUM-HIGH	70 %
4 times	MEDIUM	55 %
5 times	MEDIUM-LOW	30 %
6 times	LOW	10 %

When selecting **HIGH** Power, you can start from step 2.

## 2 Set Cooking Time

(Up to 99 minutes and 99 seconds)

## 3 Press Start

► Cooking will start. The time in the display window will begin to count down.  
**To recall** the selected power level, press Micro Power Pad.

**For 2 or 3 stage cooking**, repeat above steps 1 and 2 before pressing Start Pad.

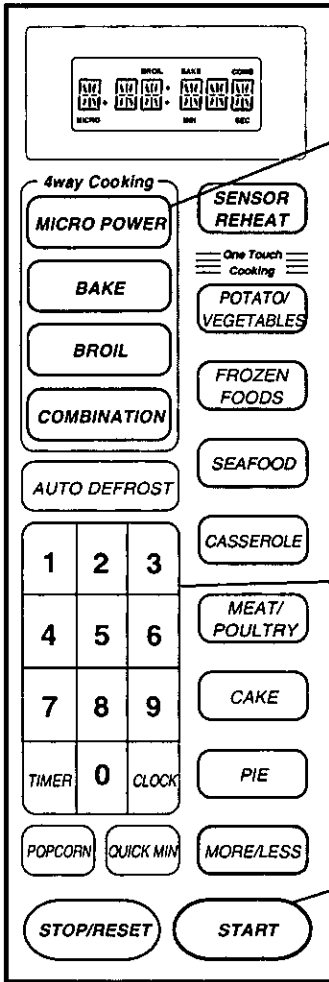

# Bake

Use of Accessory:

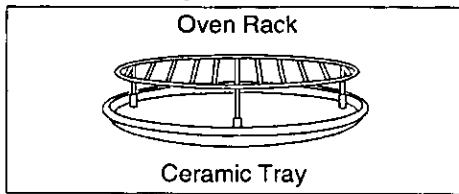

Bake temperature automatically counts-up in 25°F (10°C) increments from 200°F to 450°F (from 100°C to 230°C). Place Oven Rack on Ceramic Tray before preheating.

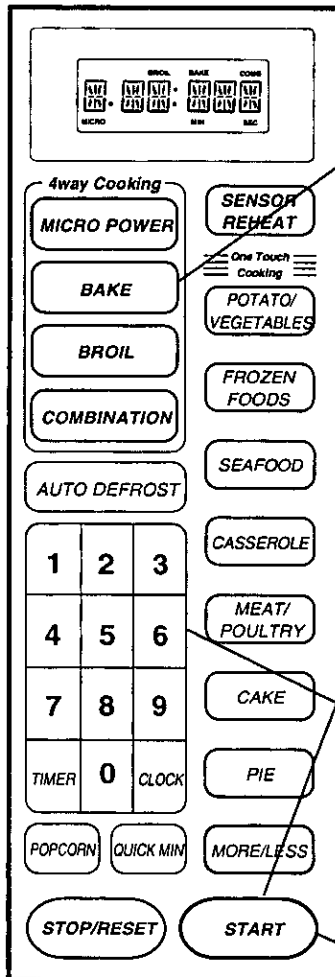

## 1 Select Oven Temperature

by pressing Bake Pad.

## 2 Press Start

► Preheating will start.

**NOTE:** During preheating "P" appears in the display window. Please do not open door.

When preheating is completed, oven will beep three times and "P END" will appear in the display window.

## 3 Place Food

in an oven-safe dish carefully on the Oven Rack.

## 4 Set Baking Time

by pressing Number Pads (up to 9 hours 99 minutes).

## 5 Press Start

► Cooking will start.

The time in the display window will count down.

### NOTE:

1. If oven door is not opened after preheating, oven will maintain the selected temperature for 60 minutes. After 60 minutes, oven will shut off automatically and beep five times.
2. When selected cooking time is less than one hour, time counts down second by second.
3. When selected cooking time is over one hour, time counts down minute by minute until 1 hour remains. The timer will then count down second by second.
4. For recipes that do not require preheating, eliminate step 2.

# Broil

Use of Accessory:

Place Oven Rack on Ceramic Tray before preheating.

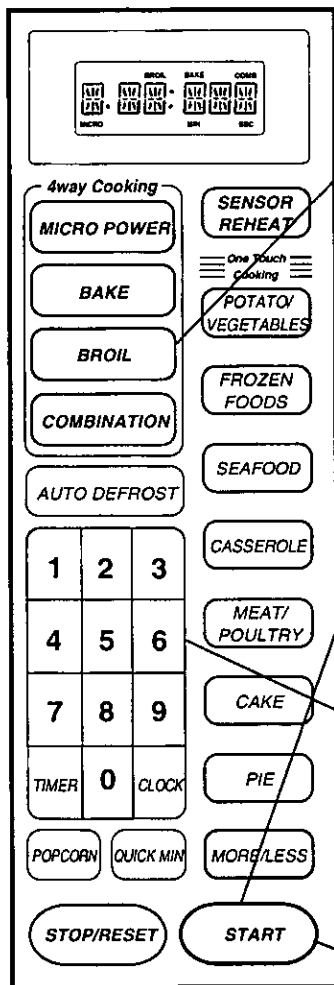
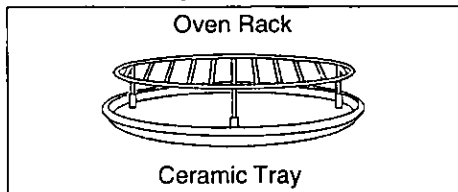

## 1 Press Broil Pad

## 2 Press Start

► Preheating will start.

**NOTE:** During preheating "P" appears in the display window. Please do not open door.

When preheating is completed, oven will beep three times and "P END" will appear in the display window.

## 3 Place Food

on spatter shield on broiler pan and carefully place on the Oven Rack.

You can purchase most broiler pans from your local stores.

## 4 Set Broiling Time

by pressing Number Pads (up to 99 minutes 99 seconds).

## 5 Press Start

► Cooking will start.

The time in the display window will count down.

### NOTE:

1. If oven door is not opened after preheating, oven will maintain the temperature for 60 minutes. After 60 minutes, oven will shut off automatically and beep five times.
2. For recipes that do not require preheating, eliminate step 2.

# Combination

Use of Accessory:

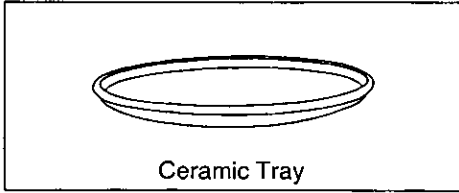

There are 4 combination settings. These settings are automatic, there is no need to set oven temperature or microwave power level.

## 1 Select Combination Setting

by pressing Combination Pad 1 to 4 times.

	Oven Temp.	Micro-wave	Food
1	275°F (130°C)	30 % power	Beef (Well), Lamb (Well)
2	300°F (150°C)		Beef (Rare, Med), Lamb (Med)
3	325°F (160°C)		Pork
4	375°F (190°C)		Chicken, Duck

## 2 Set Cooking Time

by pressing Number Pads (up to 9 hours 99 minutes).

## 3 Press Start

► Cooking will start.  
The time in the display window will count down.

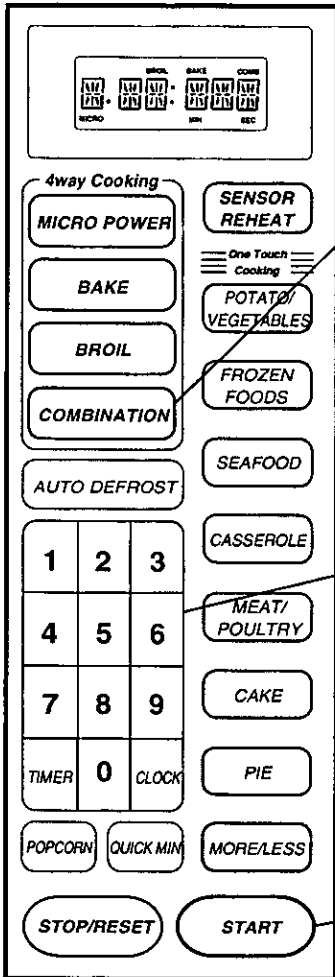

### NOTE:

1. When selected cooking time is less than one hour, time counts down second by second.
2. When selected cooking time is over one hour, time counts down minute by minute until 1 hour remains. The timer will then count down second by second.



# Auto Defrost

Use of Accessory:

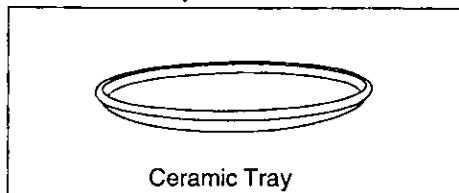

This feature allows you to defrost meat, poultry and seafood by weight without setting time.

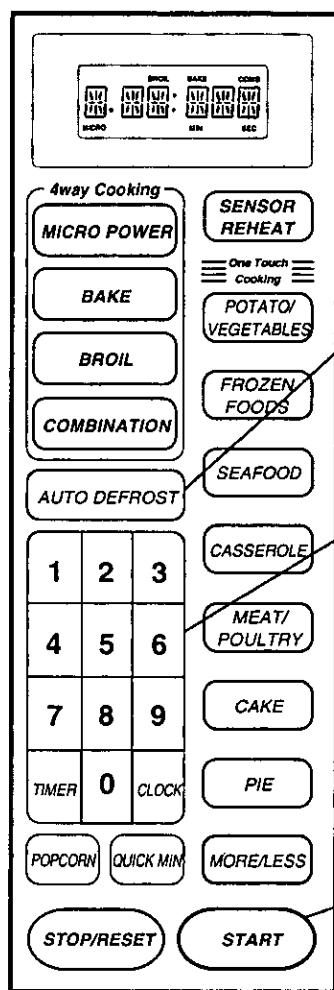

## 1 Press Auto Defrost Pad

## 2 Set Weight

Weight of the frozen food must be programmed in pounds and tenths of a pound (not ounces).

e.g. 1.5 lb (kg)

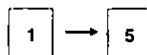

If you wish to use the kg/g, see page 10 "Conversion".

## 3 Press Start

▶ Defrosting time appears in the display window and begins to count down.

### Conversion Chart

Follow this chart to convert ounces or hundredths of a pound into tenths of a pound. If a piece of meat weighs 1.95 pounds or 1 pound 14 ounces, program 1.9 pounds.

Ounces	Hundredths of a Pound	Tenths of a Pound
0	.96 -.05	0.0
1-2	.06 -.15	0.1
3-4	.16 -.25	0.2
5	.26 -.35	0.3
6-7	.36 -.45	0.4
8	.46 -.55	0.5
9-10	.56 -.65	0.6
11-12	.66 -.75	0.7
13	.76 -.85	0.8
14-15	.86 -.95	0.9

### NOTE:

1. The shape and size of the food will determine the maximum weight the oven can accommodate. The recommended **maximum weight of meat is 4 lbs. (1.8 kg); poultry, 6 lbs. (2.7 kg) and seafood, 3 lbs. (1.4 kg).**
2. The oven beeps once during the defrosting cycle to signal that the food needs to be **turned or rearranged**. To prevent overdefrosting, thin areas or edges can be shielded with strips of aluminum foil.
3. For best results, the minimum recommended weight is **0.5 lbs. (220 g).**
4. Stand time or power level may be programmed after Auto Defrost.

# Sensor Reheat/One Touch Cooking (Sensor Cook)

Use of Accessory:

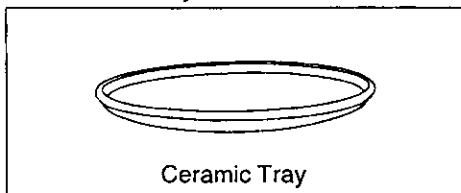

This feature allows you to reheat/cook most of your favorite foods without having to select reheating/cooking times and power levels. The oven does it all automatically.

## 1 Select Category

The Potato/Vegetables, Frozen Foods and Seafood Pads each have 2 or 3 categories. See next page.

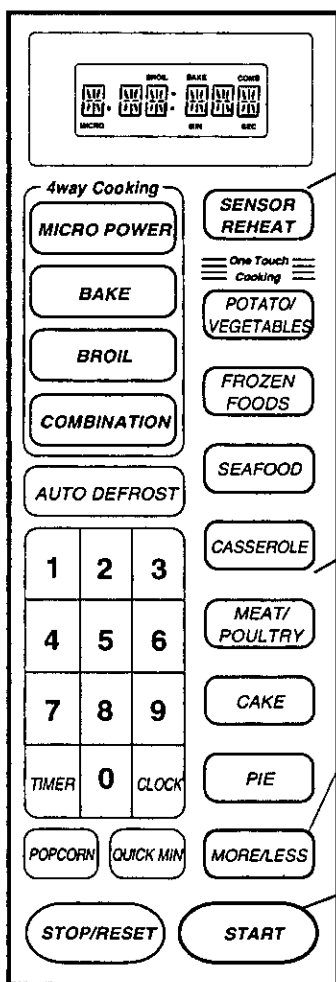

### More/Less Pad:

Preferences for food doneness vary with each individual. After having used One Touch Cooking a few times, you may decide you would prefer your food cooked to a different doneness. By using the More / Less Pad, the programs can be adjusted to cook food for a longer or shorter time.

1 tap: More cooking

2 taps: Less cooking

Press More/Less Pad before pressing Start.

## 2 Press Start

► Cooking will start.

After the burst of steam is detected by the SENSOR, the remaining cooking time appears in the display window and begins to count down.

### For best results by Sensor, follow these recommendations.

#### BEFORE Reheating/Cooking:

1. The room temperature surrounding the oven should be below 95°F (35°C).
2. Food weight should be between 4 oz (120 g) and 24 oz (680 g).
3. Ceramic Tray and outside of container should be dry.
4. Cover foods loosely, but completely, with plastic wrap or place foods in a casserole dish with a proper fitting lid.
5. All foods should be taken from their normal storage place.

#### DURING Reheating/Cooking:

While "AUTO" is displayed in the display window, DO NOT open door longer than 1 minute. This causes inaccurate cooking results. Once the timer begins to count down, the oven door may be opened to stir, turn, shield or add foods.

#### AFTER Reheating/Cooking:

All foods should have a covered stand time.

**DO NOT:**

1. Reheat bread and pastry products. Use manual power and time.
2. Reheat raw or uncooked food.
3. Use if oven cavity is warm.
4. Use for beverages.
5. Use for frozen foods.



Food	Starting Temp.	Weight per Serving	Number of Servings
Plate of Food	Refrig.	12 - 16 oz.	1
Meat, Poultry	Refrig.	4 - 6 oz.	1 - 4
Casseroles	Refrig.	8 oz.	1 - 2
Side dishes	Refrig. or Room	4 - 6 oz.	1 - 4
Soups, Sauces, Gravies	Refrig. or Room	6 - 8 oz.	1 - 2

**Casseroles** - Add 2 to 4 tablespoons of liquid; cover with lid or plastic wrap. Stir when time appears in the display window.

**Canned foods** - Empty contents into casserole dish or serving bowl; cover dish with lid or plastic wrap. After reheating, release plastic wrap and stand.

**Plate of food** - Arrange food on plate; top with butter, gravy, etc. After reheating, release plastic wrap and stand.

**SENSOR COOK - HINTS:**

	CATEGORY	WEIGHT RANGE	INSTRUCTIONS	COVER	AFTER BEEP
	1 x Potato	1 - 4 potatoes 6 - 8 oz. (170 - 230 g) each	Pierce several times and place on a microwave safe dish.	NO	Turn over.
	2 x Vegetables, fresh	1/2 - 2 lb. (230 - 900 g) weight before peeling, trimming etc.	Add water.	Lid or plastic wrap	Stir or rearrange.
	1 x Frozen Vegetables	10 - 28 oz. (280 - 800 g)	Add 2 tbs of water. Do not cook with butter or sauce.	Lid or plastic wrap	Stir or rearrange.
	2 x Frozen Entree	7 - 32 oz. (200 - 900 g)	Do not use frozen food in foil tray.	Follow manufacturers' directions.	Stir, ladle gravy or sauce over.
	3 x Frozen Dinner	9 - 18 oz. (260 - 510 g)	Do not use frozen food in foil tray.	Follow manufacturers' directions.	Stir, if possible.
	1 x Fish	1/2 - 1 1/2 lb. (230 - 680 g)	Arrange in a single layer in dish.	Lid or plastic wrap	Rearrange.
	2 x Shellfish	3/4 - 1 1/2 lb. (340 - 680 g)	Arrange in a single layer in dish.	Lid or plastic wrap	Stir shrimp or scallops.
	Casserole	—	Use appropriate amount of liquid.	Casserole lid	Stir occasionally.

**NOTE:** If Sensor Reheat/Cook is programmed while the oven cavity is still hot from heater, "HOT" appears in the display window and the fan starts running to cool the cavity. If the cavity is too hot, the sensor will not work properly. After having cooled the cavity, "HOT" will disappear and revert to colon or time of day.

One Touch Cooking is successful with the foods and recipes found in the Cookbook and marked with the Symbol **A**. Because of the vast differences in food composition, recipes and charts without the Symbol **A** should be prepared in your microwave oven using the Power and Time setting.

# One Touch Cooking (Weight Cook by Combination)

Use of Accessory:

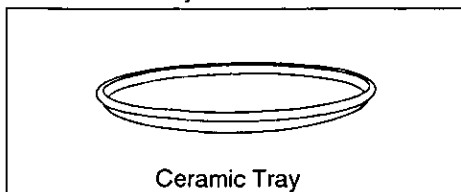

This feature allows you to roast beef, pork or whole chicken by setting the weight.

Place food on a microwave roasting rack set in a microwave- and heat-safe dish.

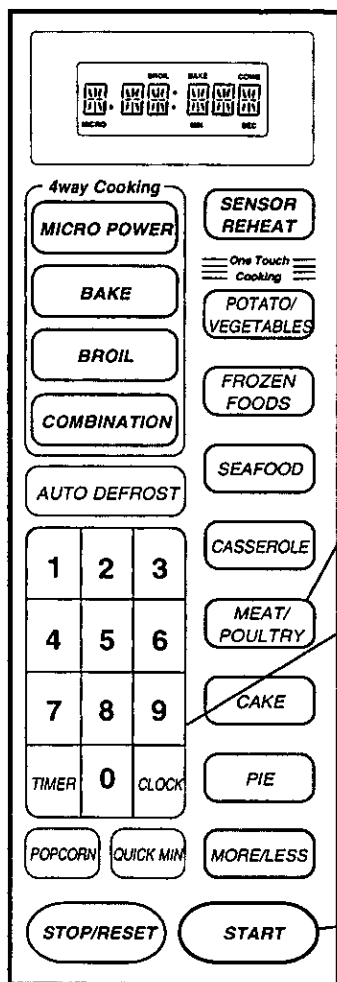

## 1 Select Category

This pad is subdivided into 3 categories; Beef, Pork and Whole Chicken.

## 2 Set Weight

e.g. 2.0 lb/kg

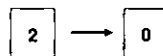

If you wish to adjust the cooking time, press More/Less Pad (See page 18).

## 3 Press Start

► Cooking will start.  
The time in the display window will count down.

### NOTE:

1. These settings are cooked by Combination (Convection and Microwave).
2. When the weight has been entered, the cooking time will be automatically determined.
3. Roasts weighing above or below the recommended weights should be cooked by manual combination.

CATEGORY	WEIGHT RANGE	INSTRUCTIONS	AFTER BEEP
Beef - medium	max. 4 lb (2 kg)	Place fat-side down.	Turn over
Pork	max. 4 lb (2 kg)	Place fat-side down. Pork must reach 170°F (77°C) before serving.	Turn over
Chicken	max. 6 lb (3 kg)	Place breast-side down.	Turn over

# One Touch Cooking (Auto Bake)

Use of Accessory:

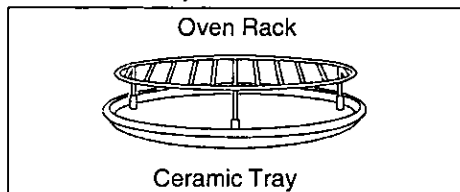

This feature allows you to bake cake or pie without having to select oven temperature and baking time.

Place Oven Rack on Ceramic Tray.

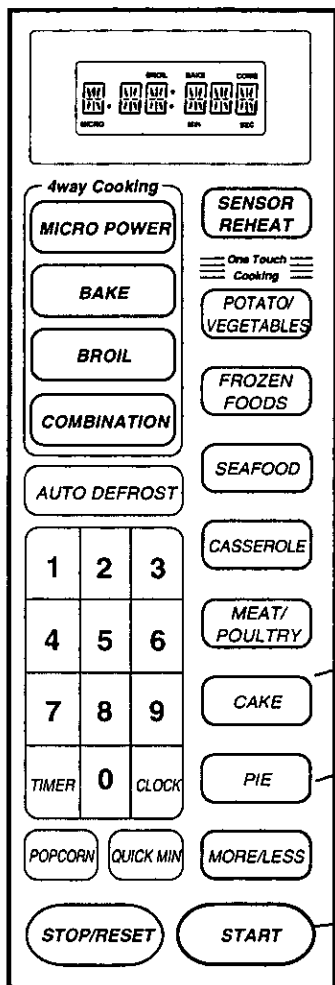

## 1 Select Category

Cake Pad is divided into 2 categories and Pie Pad is divided into 3 categories (see below).

If you wish to adjust the baking time, press More/Less Pad (See page 18).

## 2 Press Start

► Cooking will start.  
The time in the display window will count down.

### NOTE:

1. These settings are cooked by Bake.
2. There is no need to preheat.
3. Metal cookware may be used. Position the dish to be cooked on the oven rack, placed on the ceramic tray.

CAKE 1 for Cake recipes that conventionally bake in less than 35 minutes.  
CAKE 2 for Cake recipes that conventionally bake in 45 minutes to 60 minutes.

FROZEN PIE (PIE 1) for Double-crust pies that are frozen (weight should not be more than 2 lb. 5 oz.).  
FRESH PIE (PIE 2) for Double-crust pies with fresh fruit fillings.  
PRE-CKD PIE (PIE 3) for Double-crust pies with pre-cooked or canned pie filling.

- Will not bake chocolate fudge, brownies or fruit cake recipes.
- Do not use frozen pie crust.
- Place frozen pies on a small cookie sheet.

# Popcorn Function

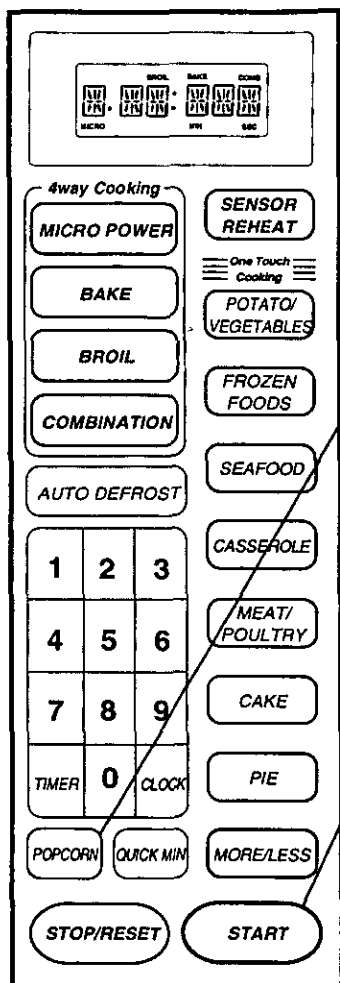

## 1 Select Weight

of prepackaged microwave popcorn.

Press	Weight
once	3.5 oz. (99 g)
twice	3.0 oz. (90 g)
3 times	1.75 oz. (50 g)

## 2 Press Start

► Cooking time appears and begins to count down.

### NOTE:

1. Use prepackaged **room temperature** microwave popcorn. Read manufacturers' instructions.
  2. Place bag in oven according to manufacturers' directions.
  3. Pop only one bag at a time.
  4. After popping, open bag carefully, popcorn and steam are extremely hot.
  5. Do not reheat unpopped kernels or reuse bag.
  6. **Never** leave oven unattended when popping popcorn.
- CAUTION:** If pre-packaged popcorn is of a different weight than the recommended weight, do not use the popcorn setting, or inadequate popping or a fire may occur. Follow the manufacturers' instructions.

# Quick Min Function

This feature helps you in programming your oven without pressing the Number Pads and allows you to add extra cooking time easily.

### To Set Cooking Time:



Set cooking time (up to 10 taps/minutes).

Press.

► Cooking will start on HIGH power.

### NOTE:

1. You can use other power levels or other cooking modes, select the desired power level or cooking mode before setting the cooking time.
2. After setting the time by Quick Min Pad, you cannot use the Number Pads, and vice versa.

### To Add Extra Cooking Time:

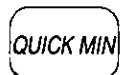

Press to add extra cooking time (up to 10 taps) during cooking.

► Cooking time changes to include extra time and continues to count down in the display window.

**NOTE:** You can add cooking time for all features with power and time settings.

# Timer Function

This feature allows you to program a Standing Time after cooking is completed and to program the oven as a minute timer and/or to program delay start.

## To Use as a Kitchen Timer

**1** Press **Timer**

**2** Set desired amount of Time

(up to 99 minutes and 99 seconds)

**3** Press **Start**

▶ Time will count down without oven operating.

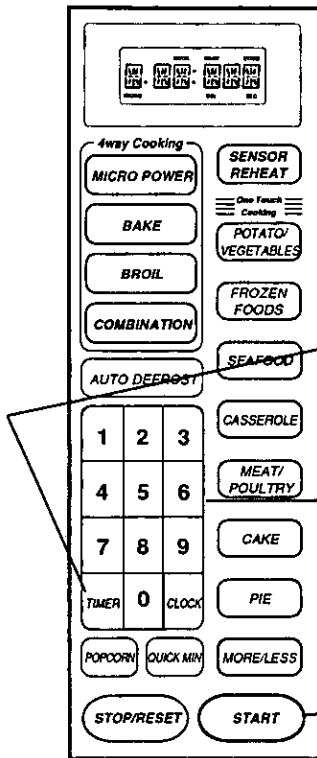

## To Set Stand Time

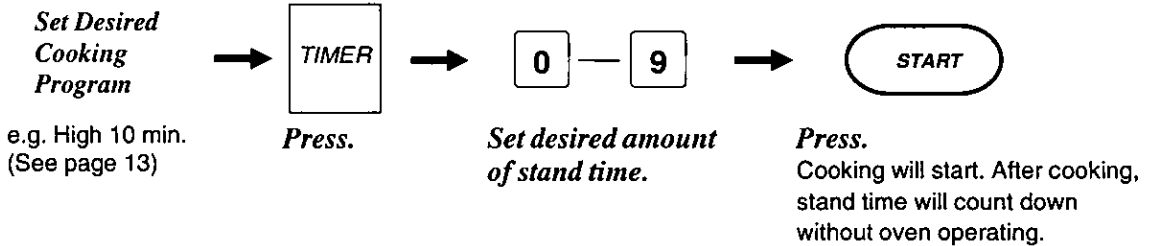

## To Set Delay Start

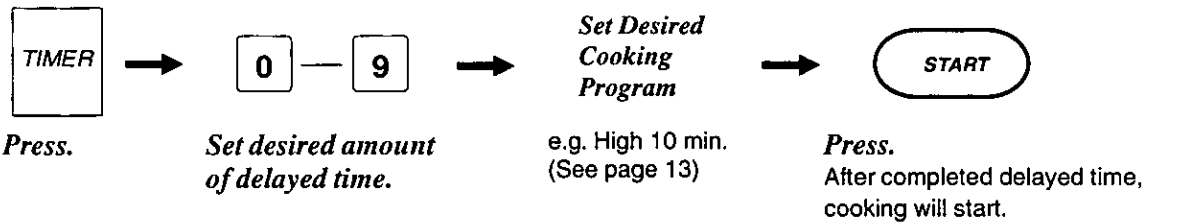

### NOTE:

1. When the first/second stage has finished, a two beep signal is heard. After all the stages have been completed, the oven will beep five times.
2. If oven door is opened during the Stand Time or Kitchen Timer, the time in the display window will continue to count down.
3. Delay Start cannot be programmed before any Auto Control Function.  
This is to prevent the starting temperature of the food from rising before defrosting or cooking begins. A change in the starting temperature could cause inaccurate cooking results.
4. Timer can be set up to 99 minutes and 99 seconds.

# Before Requesting Service

## All these things are normal:

The oven causes interference with my TV.	Some radio and TV interference might occur when you cook with the microwave oven. This interference is similar to the interference caused by small appliances such as mixers, vacuums, blow dryers, etc. It does not indicate a problem with your oven.
The oven lights dim.	When cooking with a power other than HIGH, the oven must cycle to obtain the lower power levels. The oven light will dim and clicking noises can be heard when the oven cycles.
Steam accumulates on the oven door and warm air comes from the oven vents.	During cooking, steam and warm air are given off from the food. Most of the steam and warm air are removed from the oven by the air which circulates in the oven cavity. However, some steam will condense on cooler surfaces such as the oven door. This is normal.
I accidentally ran my microwave oven without any food in it.	Running the oven empty for a short time will not damage the oven. However, we do not recommend it.

PROBLEM	POSSIBLE CAUSE	REMEDY
Oven will not turn on.	The oven is not plugged in securely.	Remove plug from outlet, wait 10 seconds and reinsert.
	Circuit breaker or fuse is tripped or blown.	Reset circuit breaker or replace fuse.
	There is a problem with the outlet.	Plug another appliance into the outlet to check if it is working.
Oven will not start cooking.	The door is not closed completely.	Close the oven door securely.
	Start Pad was not pressed after programming.	Press Start Pad.
	Another program has already been entered into the oven.	Press Stop/Reset Pad to cancel the previous program and program again.
	The program is not correct.	Program again according to the Operating Instructions.
	Stop/Reset Pad has been pressed accidentally.	Program oven again.
The words "DEMO MODE" appear in the display window.	Clock Pad has been pressed three times.	Deactivate mode by pressing Clock Pad three times.
When the oven is turning on, there is noise coming from the ceramic tray.	The roller ring and oven bottom are dirty.	Clean these parts according to "Care of Your Microwave Oven" (next page).

If it seems there is a problem with the oven, contact an authorized Servicenter.



# Care of Your Microwave Oven

## BEFORE CLEANING:

Unplug the oven. If impossible, leave oven door open to prevent oven from accidentally turning on.

## AFTER CLEANING:

Be sure to replace the Roller Ring and Ceramic Tray in the proper position and press Stop/Reset Pad to clear the display window.

### Inside of the oven:

Wipe with a damp cloth. Non caustic oven cleaners may be used if the oven gets very dirty. The use of harsh detergent or abrasives is not recommended.

**Note:** Do not use oven cleaners on the top of the oven.

### Ceramic tray:

Remove and wash in warm sudsy water or in dishwasher. If grease accumulates, clean with a nonabrasive nylon mesh scouring pad and non caustic oven cleaners.

### Outside oven surfaces:

Clean with a damp cloth. To prevent damage to the operating parts inside the oven water should not be allowed to seep into the ventilation openings.

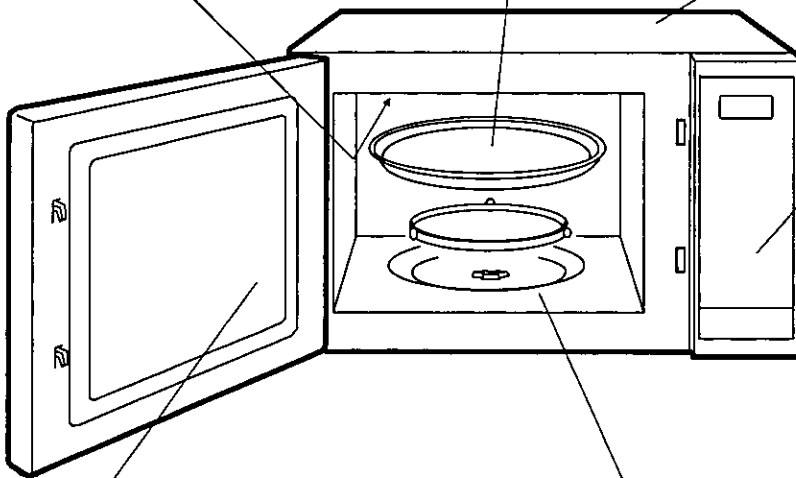

### Control panel:

If it becomes wet, clean with a soft, dry cloth. Do not use harsh detergents or abrasives on the Control Panel.

### Oven door:

Wipe with a soft cloth when steam accumulates inside or around the outside of the oven door.

During cooking, especially under high humidity conditions, steam is given off from the food. (Some steam will condense on cooler surfaces, such as the oven door.) This is normal.

### The roller ring and oven cavity floor:

Wipe the bottom surface of the oven with mild detergent water or window cleaner and dry. The roller ring may be washed in mild sudsy water or dishwasher. These areas should be kept clean to avoid excessive noise.

After Bake/Broil/Combination cooking, the oven should be cleaned with a soft cloth squeezed in soapy water. If the oven is not cleaned occasionally to eliminate this grease, it can accumulate and cause the oven to "SMOKE" during use. To avoid smoking, run the oven without food on BROIL for 20 minutes.

# Technical Specifications

---

Power Source:	120 V, 60 Hz (50/60 Hz for NN-9854P)
Power Consumption: (microwave)	12.8 A, 1,500 W
(heater)	12.5 A, 1,500 W
Output: (microwave)*	850 W
(heater)	1,400 W
Outside Dimensions	14 <sup>13</sup> / <sub>16</sub> × 23 <sup>7</sup> / <sub>8</sub> × 19 <sup>5</sup> / <sub>16</sub> "
(H × W × D):	(376 × 606 × 491 mm)
Oven Cavity Dimensions	9 <sup>1</sup> / <sub>2</sub> × 16 <sup>1</sup> / <sub>4</sub> × 16 <sup>13</sup> / <sub>16</sub> "
(H × W × D):	(242 × 412 × 426 mm)
Trim Kit:	NN-TK909W (for NN-9854/NN-9854P)
	NN-TK909 (for NN-9804)
Operating Frequency:	2,450MHz
Uncrated Weight:	Approx. 54 lbs. (24.5 kg)

\*IEC 705-88 Test procedure  
Specifications subject to change without notice.

**Matsushita Consumer Electronics  
Company, Division of Matsushita  
Electric Corporation of America**  
One Panasonic Way,  
Secaucus, New Jersey 07094

**Panasonic Sales Company,  
Division of Matsushita Electric of  
Puerto Rico, Inc. ("PSC")**  
Ave. 65 de Infantería, Km. 9.5  
San Gabriel Industrial Park,  
Carolina, Puerto Rico 00985

**A00036670AP**  
F0794-0  
Printed in Japan