

This Owner's Manual is provided and hosted by [Appliance Factory Parts](#).



PANASONIC NN-C980W Owner's Manual

[Shop genuine replacement parts for PANASONIC
NN-C980W](#)



[Find Your PANASONIC Microwave Parts - Select From 742 Models](#)

----- Manual continues below -----

Panasonic®

Operating Instructions

Microwave/Convection Oven Model NN-C980B/NN-C980W

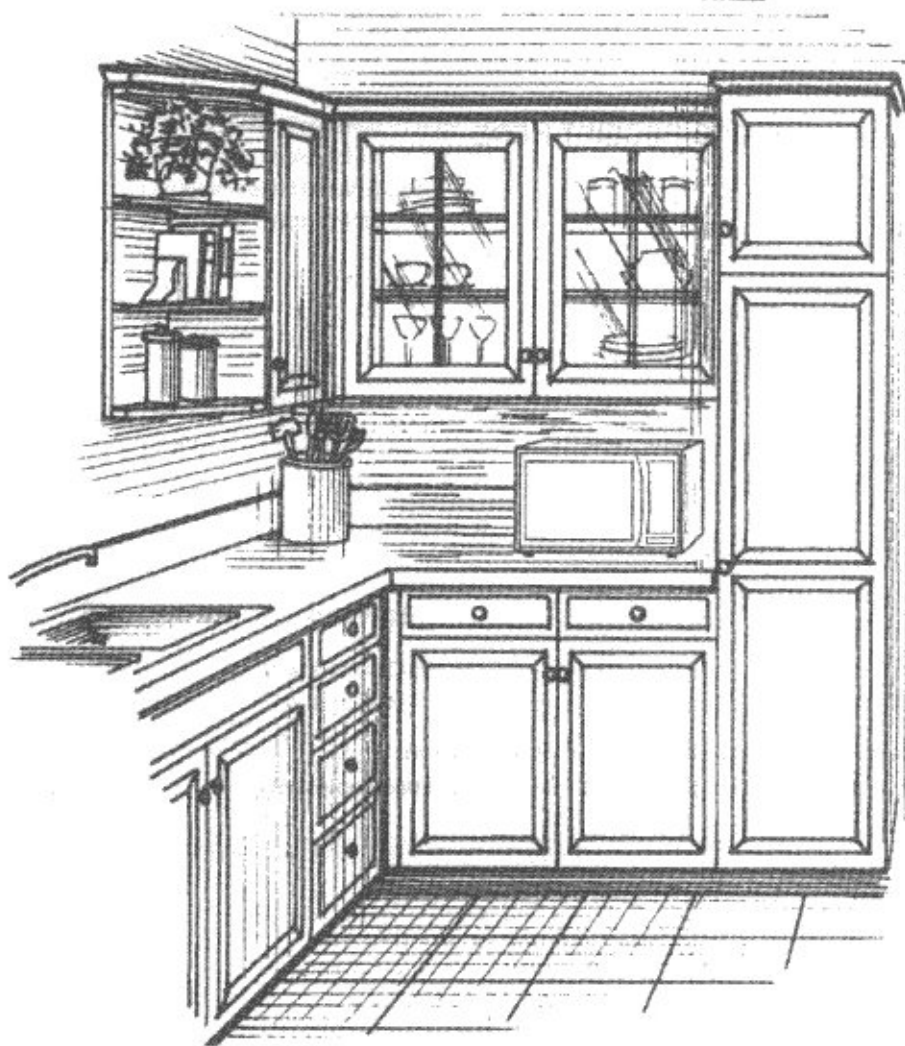

*Before operating this oven, please read these instructions completely.
Antes de operar este producto, lea este instructivo en su totalidad.
La referencia rápida en español puede ser encontrada en la páginas 25-42
(Spanish quick reference can be found on pages 25-42.)*

***For assistance, please call : 1-800-211-PANA(7262)
or send e-mail to : consumerproducts@panasonic.com***

PRECAUTIONS TO AVOID POSSIBLE EXPOSURE TO EXCESSIVE MICROWAVE ENERGY

- (a) Do not attempt to operate this oven with the door open since open-door operation can result in harmful exposure to microwave energy. It is important not to defeat or tamper with the safety interlocks. Under normal conditions, the oven will not operate with the door open.
- (b) Do not place any object between the oven front face and the door, or allow soil or cleaner residue to accumulate on sealing surfaces.
- (c) Do not operate the oven if it is damaged. It is particularly important that the oven door close properly and that there is no damage to the :
 - (1) door (bent)
 - (2) hinges and latches (broken or loosened)
 - (3) door seals and sealing surfaces.
- (d) The oven should not be adjusted or repaired by anyone except properly qualified service personnel.

EXAMINE YOUR OVEN

Unpack oven, remove all packing material.

Examine the oven for any damage such as dents, broken door latches or cracks in the door. Check that none of the accessories are missing, by following the list below.

Roller Ring



Place the Roller Ring correctly on the oven floor.

Oven Rack

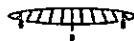

Oven Rack should be used for Bake and Broil cooking.

Ceramic Tray



Place the Ceramic Tray exactly on Roller Ring. Always use Roller Ring and Ceramic Tray in proper position.

Operating Instructions

Cookbook

Notify dealer immediately if oven is damaged. **DO NOT** install if oven is damaged.

The serial number of this product may be found on the right side of the oven door opening. You should note the model number and the serial number of this oven in the space provided and retain this book as a permanent record of your purchase for future reference.

Model No. _____

Serial No. _____

Date of Purchase _____

CONTENTS

Before Operation

IMPORTANT SAFETY INSTRUCTIONS	4
Installation and GROUNDING INSTRUCTIONS	5
Practical Hints	6-7
Feature Diagram	8
Cooking Modes : Heating Source	8
Control Panel	9

Operation & Hints

To Use Function	10
Let's Start to Use Your Oven!	11
To Set Clock	11
To Defrost Micro Power and Time Setting	12
Using Turbo Defrost Pad	17
To Reheat Micro Power and Time Setting	12
Using Sensor Reheat Pad	18-19
To Cook Micro Power and Time Setting	12
on Bake	13
on Broil	14
on Combination	15
Using Popcorn Pad	16
Using Sensor Cooking	18-19
Using Convection Cooking (Weight Cook by Combination)	20
Using Convection Cooking (Auto Cook by Bake)	21
Using Quick Min Pad	12
To Use Keep Warm Pad	16
To Use Timer Function	22
Quick Guide to Operation	43

Maintenance

Before Requesting Service	23
Care of Your Microwave Oven	24
Technical Specifications	44

Referencia Rápida

INSTRUCCIONES DE SEGRIDAD	25
INSTRUCCIONES DE INSTALACIÓN	26
SUGERENCIAS UTILES	27
GUÍA PARA COCINAR Y UTENSILIOS	28
Diagrama de Características	29
Modos de Cocción	29
Panel de Controles	30
Funciones	31
Para Ajustar el Reloj	32
Recalentamiento/Descongelación/Cocción con selección de Potencia y Tiempo	32
Hornear	33
Parrilla	34
Combination	35
Descongelación Turbo	36
Sensor de Recalentamiento Automático	36
Sensor de cocción Automática	37-38
Cocción Automática por Peso (Combinación)	39
Horneado Automática	39
Pulsadores de Palomitas de Maíz	40
Función Rapido en Minutos	40
Temporizador (Timer)	41
Cuidados de Su Horno de Microondas	42
Antes de Acudir a Servicio	42
Especificaciones Técnicas	44

Before Operation

Operation & Hints

Maintenance

Referencia Rápida

IMPORTANT SAFETY INSTRUCTIONS

Your microwave oven is a cooking device and you should use as much care as you use with a stove or any other cooking device. When using this electric appliance, basic safety precautions should be followed, including the following:

WARNING—To reduce the risk of burns, electric shock, fire, injury to persons or exposure to excessive microwave energy:

1. Read all instructions before using the appliance.
2. Read and follow “**PRECAUTIONS TO AVOID POSSIBLE EXPOSURE TO EXCESSIVE MICROWAVE ENERGY**,” found on page 2.
3. This appliance must be grounded. Connect only to a properly grounded outlet. See “**Grounding Instructions**” found on page 5.
4. Install or locate this appliance only in accordance with the provided installation instructions found on page 5.
5. Do not cover or block any openings on this appliance.
6. Do not store or use this appliance outdoors. Do not use this product near water—for example, near a kitchen sink, in a wet basement, or near a swimming pool, and the like.
7. Use this appliance only for its intended use as described in this manual. Do not use corrosive chemicals or vapors in this appliance. This type of oven is specifically designed to heat, or cook food. It is not designed for industrial or laboratory use.
8. When cleaning surfaces of door and oven that come together on closing the door, use only mild, non-abrasive soaps or detergents applied with a sponge or soft cloth.
9. As with any appliance, close supervision is necessary when used by children.
10. Do not operate this appliance if it has a damaged cord or plug, if it is not working properly, or if it has been damaged or dropped.
11. Do not immerse cord or plug in water.
12. Keep cord away from heated surfaces.
13. Do not let cord hang over edge of table or counter.
14. This appliance should be serviced only by qualified service personnel. Contact the nearest authorized service facility for examination, repair or adjustment.
15. Some products such as whole eggs and sealed containers (for example, closed glass jars) may explode and should not be heated in this oven.
16. To reduce the risk of fire in the oven cavity:
 - (a) Do not overcook food. Carefully attend appliance if paper, plastic, or other combustible materials are placed inside the oven to facilitate cooking.
 - (b) Remove wire twist-ties from paper or plastic bags before placing bag in oven.
 - (c) If materials inside the oven should ignite, keep oven door closed, turn oven off, and disconnect the power cord, or shut off power at the fuse or circuit breaker panel.

- (d) Do not use the cavity for storage purposes. Do not leave paper products, cooking utensils, or food in the cavity when not in use.

17. **To avoid the possible risk of a burn**, the appliance must not be used in areas such as island-type countertops where the rear surfaces would be exposed to user contact and the appliance must be placed more than 3 feet (85 cm) above the floor.

General Use

1. **DO NOT** tamper with or make any adjustments or repairs to the door, control panel housing, safety interlock switches or any other part of the oven.
DO NOT remove outer panel from oven. Repairs should only be done by qualified service person.
2. **DO NOT** use the microwave function when the oven is empty. The microwave energy will reflect continuously throughout the oven, if food or water is not present to absorb energy. This could damage the oven and result in the danger of a fire.
3. **DO NOT** use this oven to heat chemicals or other non-food products. **DO NOT** clean this oven with any product that is labeled as containing corrosive chemicals. **The heating of corrosive chemicals in this oven can cause radiation leaks.**
4. **DO NOT** dry clothes, newspapers or other materials in the oven. They may catch on fire.
5. **DO NOT** use recycled paper products unless the paper product is labeled as safe for microwave oven use. Recycled paper products may contain impurities which may cause sparks and/or fires when used.
6. **DO NOT** use newspapers or paper bags for cooking. Fire can result.
7. **DO NOT** hit or strike the control panel. Damage to the controls may occur. Fire can result.
8. **DO NOT** store flammable materials next to, on top of, or in the oven. These could be fire hazards.
9. **POT HOLDERS** may be needed when handling dishes. Heat is transferred from the hot food to the cooking container and from the cooking container to Glass Tray. Glass Tray can be very hot after removing cooking container from oven.
10. Before using the **BAKE, COMBINATION** or **BROIL** functions for the first time, operate the oven without food on BROIL for 20 minutes. This will allow the oil that is used for rust protection to be burned off.
11. Door and exterior will get hot during **BAKE, COMBINATION** and **BROIL**. Please handle door carefully.
12. Use extreme caution when removing oven accessories or cooking containers from oven or disposing of hot grease.

SAVE THESE INSTRUCTIONS

Installation & GROUNDING INSTRUCTIONS

Before Operation

Placement of Your Oven

1. Oven must be placed on a flat, stable surface. For proper operation, the oven must have sufficient air flow. Allow 3" (8 cm) of space on both sides of the oven and 6" (15 cm) of space on top of the oven.
 - a. DO NOT block air vents. If they are blocked during operation, the oven may overheat. If the oven overheats, a thermal safety device will turn the oven off. The oven will remain inoperable until it has cooled.
 - b. DO NOT place the oven near a hot, damp surface such as a gas or electric range, or dishwasher.
 - c. DO NOT operate the oven when room humidity is too high.
2. This oven was manufactured for household use only.
3. This oven may be built into a wall cabinet, if desired, by using the proper trim kit, which may be purchased from a local dealer. Follow all installation instructions packed with kit.

Grounding Instructions

This appliance must be grounded. In the event of an electrical short circuit, grounding reduces the risk of electric shock by providing an escape wire for the electric current. This appliance is equipped with a cord having a grounding wire with a grounding plug. The plug must be plugged into an outlet that is properly installed and grounded.

WARNING—Improper use of the grounding plug can result in a risk of electric shock.

Consult a qualified electrician or service person if the grounding instructions are not completely understood, or if it is uncertain whether the appliance is properly grounded or not.

If it is necessary to use an extension cord, use only a three wire extension cord that has a three-blade grounding plug, and a three-slot receptacle that will accept the plug on the appliance. The marked rating of the extension cord should be equal to, or greater than, the electrical rating of the appliance.

Power Supply

1. A short power-supply cord is provided to reduce the risks resulting from becoming entangled in or tripping over a longer cord.
2. Longer cord sets or extension cords are available and may be used if care is exercised in their use.
3. If a long cord or extension cord is used, (1) the marked electrical rating of the cord set or extension cord should be at least as great as the electrical rating of the appliance, (2) the extension cord must be a grounding-type 3-wire cord, and (3) the longer cord should be arranged so that it will not drape over the countertop or tabletop where it can be pulled on by children or tripped over accidentally.

Wiring Requirements

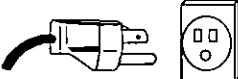
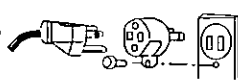
1. The oven must be on a SEPARATE CIRCUIT. No other appliance should share the circuit with the microwave oven. If it does, the branch circuit fuse may blow or the circuit breaker may trip, or the food may cook slower than recommended in this manual.
2. The VOLTAGE used must be the same as specified on this microwave oven (120 V). Using a higher voltage is dangerous and may result in a fire or other accident causing oven damage. Using a lower voltage will cause slow cooking. Panasonic is **NOT** responsible for damage resulting from the use of the oven with other than specified voltage.
3. The oven must be plugged into at least a 20 AMP, 120 VOLT, 60 Hz GROUNDED OUTLET. Where a standard two-prong outlet is encountered, it is the personal responsibility and obligation of the consumer to have it replaced with a properly grounded three-prong outlet.
4. A TEMPORARY CONNECTION with a two-prong adapter may be made where LOCAL CODES PERMIT it. Unless the cover screw is grounded through the house wiring, attaching the adapter grounding plate to the cover screw will not ground the oven. If there is any doubt that the cover screw is grounded, have it checked by an electrician.

Radio Interference

1. Operation of the microwave oven may cause interference to your radio, TV or similar equipment.
2. When there is interference, it may be reduced or eliminated by taking the following measures:
 - a. Clean door and sealing surfaces of the oven (See Care of Your Microwave Oven found on page 24)
 - b. Place the radio, TV, etc. away from the microwave oven as far as possible.
 - c. Use a properly installed antenna to obtain stronger signal reception.

Fan Motor Operation

After using the oven, the fan rotate to cook the electric components. This is perfectly normal, and you can take out the food from the oven while the fan operates.

Practical Hints

Follow These Safety Precautions When Cooking in Your Oven

1) HOME CANNING / DRYING FOODS / SMALL QUANTITIES OF FOODS

- Do not use your combination oven for home canning or the heating of any closed jar. Pressure will build up and the jar may explode. In addition, the combination oven cannot maintain the food at the proper canning temperature. Improperly canned food may spoil and be dangerous to consume.

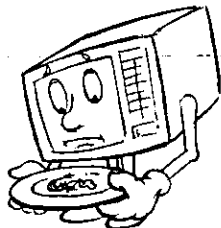

- Small quantities of food or foods with low moisture content can dry out, burn or catch on fire. If a fire occurs, turn oven off and leave oven door closed. Disconnect the power cord or shut off power at the fuse or circuit breaker panel.
- Do not dry meats, herbs, fruits or vegetables in your oven.

IMPORTANT

Proper cooking depends on time set and weight of food. If you use a smaller portion than recommended and cook at the time for the recommended portion, fire can result. If a fire occurs, turn oven off and leave oven door closed. Disconnect the power cord or shut off power at the fuse or circuit breaker panel.

2) POPCORN

Popcorn must be popped in a microwave oven corn popper. Microwave popcorn which pops in its own package is also available. Follow popcorn manufacturers' directions and use a brand suitable for the wattage of your combination oven. Never leave oven unattended when popping popcorn.

CAUTION:

When using pre-packaged microwave popcorn, follow recommended package instructions.

Check package weight before using the popcorn pad. Set the oven for the weight of the popcorn package. (see page 16) If these instructions are not followed, the popcorn may not pop adequately or may ignite and cause a fire.

3) DEEP FAT FRYING

- Do not attempt to deep fat fry in your microwave oven. Oil can be heated beyond ideal temperatures very quickly in a microwave oven. Temperatures can climb high enough for the cooking oils to reach their respective flash points and burst into flames. The heated oil may bubble and spatter causing possible damage to the oven and perhaps resulting in burns. Additionally, microwave-safe utensils may not be able to withstand the temperature of the hot oil, and could result in the utensil shattering if it contains even a slight imperfection, scratch or chip.

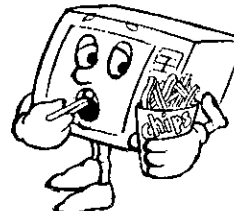

4) EGGS

- Do not heat eggs in their shell in a microwave oven. Pressure will build up and the eggs will explode.

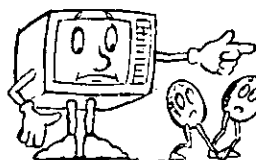

5) FOODS WITH NONPOROUS SKINS

- Potatoes, apples, egg yolks, whole squash and sausages are examples of foods with nonporous skins. This type of food must be pierced before cooking, to prevent their bursting.

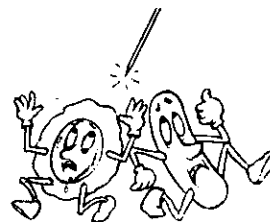

6) LIQUIDS

- Heated liquids can erupt if not mixed with air. Do not heat liquids in your microwave oven without first stirring.

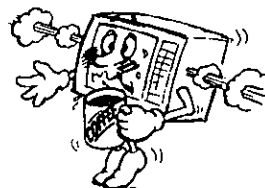

Practical Hints

Before Operation

7) CERAMIC TRAY / COOKING UTENSILS / FOIL

- Cooking utensils get hot during cooking. Use potholders when removing utensils and Glass Tray from the oven or when removing lids or plastic wrap covers from cooking utensils to avoid burns.
- Ceramic Tray will get hot during cooking. It should be allowed to cool before handling or before paper products, such as paper plates, napkins or microwave popcorn bags, are placed in the oven for microwave cooking.
- During cooking, heat is transferred from the hot food to the cooking utensil and from the utensil to Ceramic Tray. Ceramic Tray can be very hot after removing cooking utensils from oven.
- When using foil, skewers, warming rack or utensils made of metal in the oven, allow at least 1-inch (2.5 cm) of space between metal material and interior oven walls. If arcing occurs (sparking) remove metal material (skewers etc.) and/or transfer to a non-metallic container.
- Dishes with metallic trim should not be used during Microwave or **Combination** cooking, arcing may occur.

8) PAPER TOWELS / CLOTHS

- Do not use paper towels or cloths which contain a synthetic fiber woven into them. The synthetic fiber may cause the towel to ignite.
- Do not use paper bags or recycled paper products in the microwave oven.

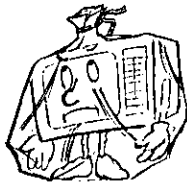

9) BROWNING DISHES / OVEN COOKING BAGS

- Microwave browning dishes or grills are designed for microwave cooking only. Preheating times vary depending on the size of the browning dish and food being cooked. Always follow instructions provided by the browning dish or grill manufacturer. Do not preheat browning dish more than 8 minutes.
- If an oven cooking bag is used for microwave cooking, prepare according to package directions. Do not use wire twist-tie to close bag. Instead use nylon tie, a piece of cotton string or a strip cut from the open end of the bag. Make six 1/2-inch slits by closure. Place oven cooking bag in a dish slightly larger than the food being cooked.

10) THERMOMETERS

- Do not use a conventional meat thermometer for Microwave or Combination cooking. Arcing may occur. Do not use a microwave meat thermometer for Combination cooking or Bake. It may melt.

11) BABY FORMULA / FOOD

- Do not heat baby formula or food in the microwave oven. The glass jar or surface of the food may appear warm while the interior can burn the infant's mouth and esophagus.

12) REHEATING PASTRY PRODUCTS

- When reheating pastry products, check temperatures of any fillings before eating. Some foods have fillings which heat faster and can be extremely hot while the surface remains warm to the touch (ex. Jelly Donuts).

13) GENERAL OVEN USAGE GUIDELINES / OVEN DOOR

- Do not use the oven for any reason other than the preparation of food.
- Do not leave oven unattended while in use.
- The oven door and the interior walls will get hot during Combination, Bake and Broil cooking.

Feature Diagram

Before Operation

Ceramic Tray

1. Do not operate the oven without the Roller Ring and Ceramic Tray in place.
2. Only use Ceramic Tray specifically designed for this oven. Do not substitute any other Ceramic Tray.
3. If Ceramic Tray is hot, allow to cool before cleaning or placing in water.
4. Do not cook directly on Ceramic Tray unless otherwise indicated. Always place food in a microwave-safe dish, or on a rack set in a microwave-safe dish.
5. Ceramic Tray can rotate in either direction.
6. If food or utensil on Ceramic Tray touches the oven walls, causing the tray to stop moving, the tray will automatically rotate in the opposite direction. This is normal.

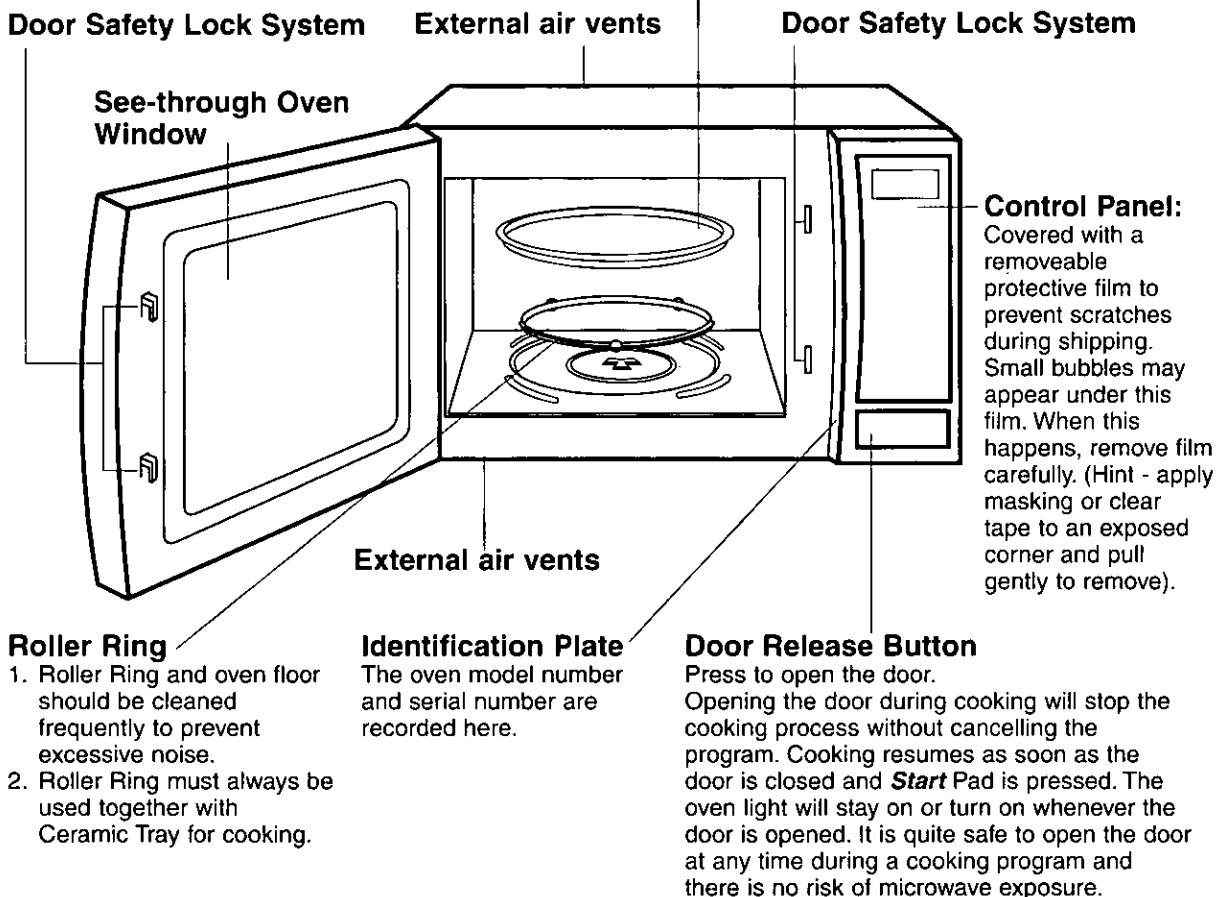

Cooking Modes: Heating Source

The diagram below shows examples of the accessories. Use of these accessories may vary depending on the recipe/dish used. Further information can be found in the Cookbook.

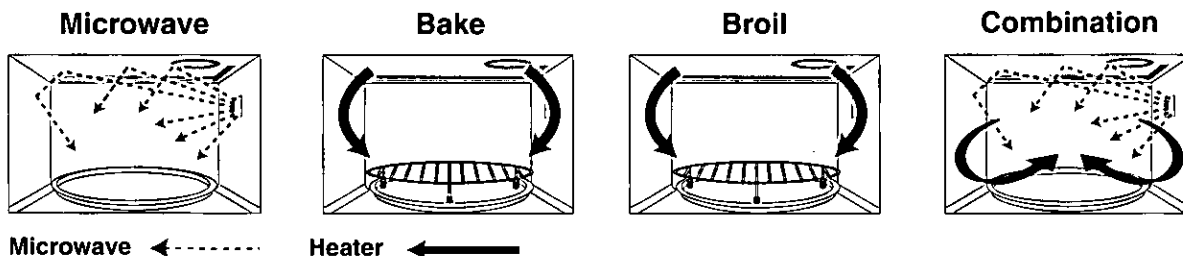

Control Panel

Before Operation

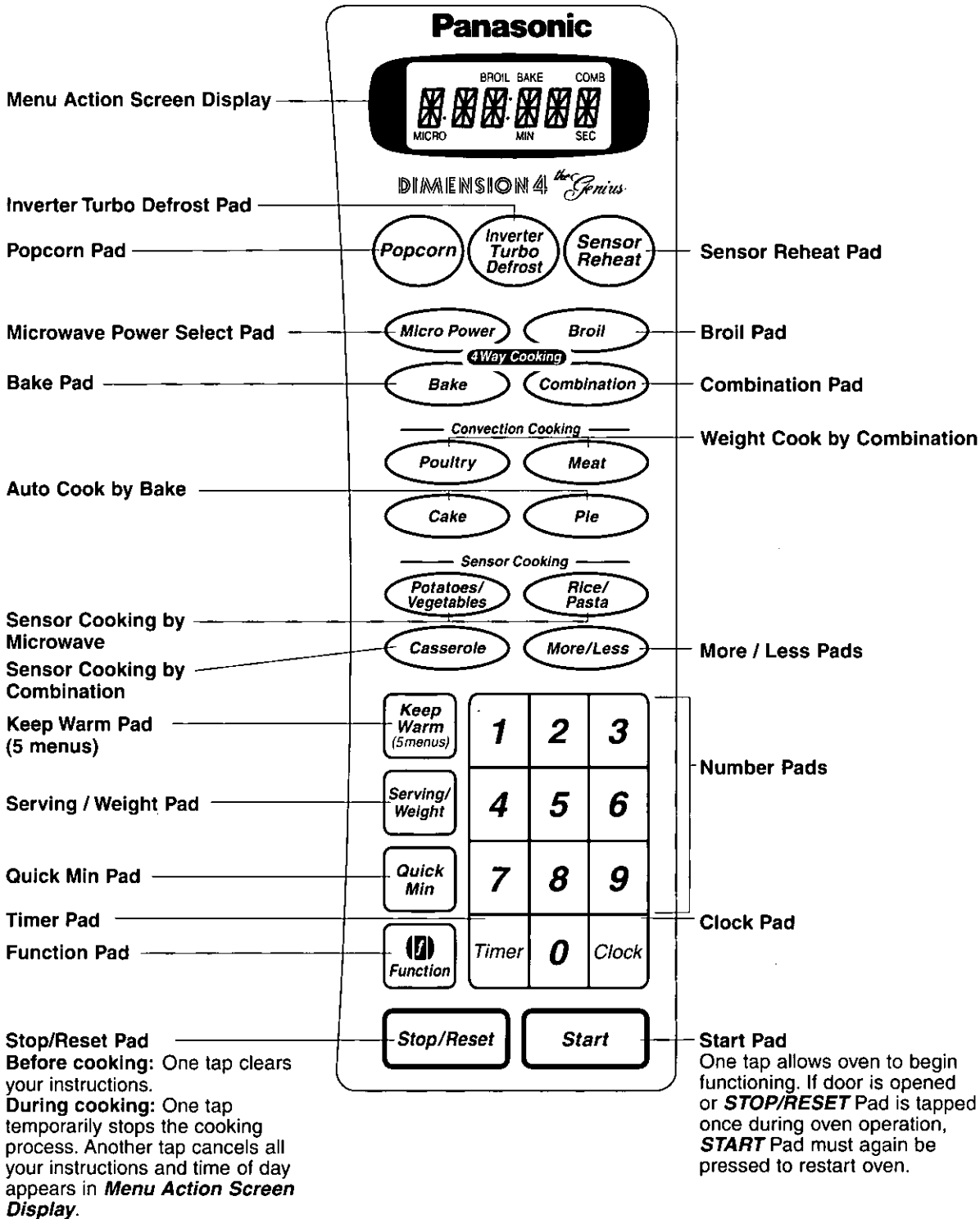

Prompters:

When a pad is pressed, a beep sound is heard and the corresponding letter or word(s) appear and scroll across the *Menu Action Screen Display*. If a pad is pressed and no beep is heard, the unit does not or cannot accept the instruction. As each pad is pressed the corresponding word(s) scroll across the screen. Words will automatically appear to prompt user to perform the next step. It is not necessary to wait for the words to appear before pressing pads for the next step. A two beep sound is heard between stages. At the end of any complete program, the oven will beep five times.

To Use Function

The unique function feature of your PANASONIC microwave oven allows you to set the non-cooking features of your ovens such as CHILD LOCK, WORD SPEED, LANGUAGE CHOICE (ENGLISH, SPANISH OR FRENCH), plus many more. See below. The initial settings are in bold.

Function	Setting	Description
1	LANGUAGE CHOICE	The oven has English, French and Spanish displays. The default setting is English. 1. ENGLISH → Display appears in English. 2. FRANCAIS → Display appears in French. 3. ESPANOL → Display appears in Spanish.
2	Lb/kg CHOICE	The oven has both imperial and metric weight measurements. The oven displays the weight in imperial measurements. 1. Lb °F → Weight can be set in lb/oz and oven temperature can be set in °F 2. kg °C → Weight can be set in kg/g and oven temperature can be set in °C
3	WORD SPEED	The word scrolling speed can be accelerated or slowed down. 1. QUICK → Words scroll quickly. 2. MEDIUM → Scrolling speed returns to initial setting. 3. SLOW → Words scroll slowly.
4	MENU ACTION ON/OFF	MENU ACTION SCREEN helps you program your oven by prompting you with the next step. When you become familiar with your oven, the Prompting Guide can be turned off. 1. ON → Prompting Guide will appear. 2. OFF → Prompting Guide will not appear.
5	CHILD LOCK ON/OFF	The Child Safety Lock feature prevents children from using the oven. 1. ON → Child Lock has been set and operation is impossible. 2. OFF → Child Lock has been cancelled.
6	BEEP ON/OFF	If you wish to have the oven operate without beeping, this feature can be turned off. 1. ON → Beep sound will be heard. 2. OFF → Beep sound will not be heard.
7	REMINDER BEEP ON/OFF	A reminder beep reminds you to remove the food from the oven after cooking is complete. The oven beeps every few seconds. 1. ON → Reminder beep activated. 2. OFF → Reminder beep deactivated.
8	DAYLIGHT SAVING ON/OFF	1. ON → Time of day will advance one hour. 2. OFF → Time of day return to original setting.
9	CLOCK ON/OFF	Clock display can be turned off. 1. ON → Time of Day display will appear in the <i>Menu Action Screen Display</i> . 2. OFF → Time of Day display will not appear in the <i>Menu Action Screen Display</i> . Time of day will remain in memory even when the display is off.
0	DEMO MODE ON/OFF	Demo mode is designed for retail store display. In this mode, the oven can be demonstrated without turning the oven on. 1. ON → Demo mode is activated. 2. OFF → Demo mode is deactivated.

Micro Power and Time Setting

Use of Accessory:

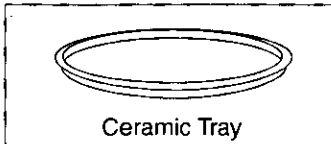

1 Select Power Level

Press	Power Level
once	P10 (HIGH)
twice	P9
3 times	P8
4 times	P7 (MEDIUM-HIGH)
5 times	P6 (MEDIUM)
6 times	P5
7 times	P4
8 times	P3 (MEDIUM-LOW)
9 times	P2
10 times	P1 (LOW)

For P10 Power, you can start from step 2.

2 Set Cooking Time

(P10 → up to 30 minutes
Others → up to 99 minutes and 99 seconds.)

3 Press

◀ Cooking will start. The time in the **Menu Action Screen Display** will begin to count down.

To recall the selected power level, press **Micro Power** pad.

For 2 or 3 stage cooking,
Repeat above steps 1 and 2 before pressing **Start** Pad.

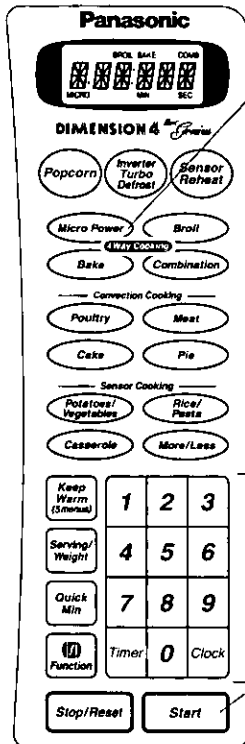

Operation & Hints

To Use Quick Min Pad

This feature helps you in programming your oven without pressing the Number Pads and allows you to add extra cooking time easily.

To Set Cooking Time:

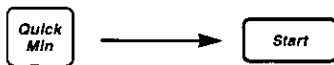

Set cooking time (up to 10 taps/minutes). Press. ◀ Cooking will start on P10 power.

To Add Extra Cooking Time:



Press to add extra cooking time (up to 10 taps) during cooking.

◀ Cooking time changes to include extra time and continues to count down in the **Menu Action Screen Display**.

NOTE:

1. You can use other power levels or other cooking modes, select the desired power level or cooking mode before setting the cooking time.
2. After setting the time by **Quick Min** Pad, You cannot use the Number Pads, and vice versa.

NOTE:

You can add cooking time for all features with power and time settings.

To Cook on Bake

Use of Accessory:

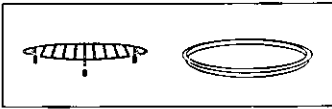

Oven Rack & Ceramic Tray

Bake temperature automatically counts-up in 25°F (10°C) increments from 200°F to 450°F (from 100°C to 230°C). Place Oven Rack on Ceramic Tray before preheating.

1 Select Oven Temperature

by pressing **Bake** Pad.

2 Press

Preheating will start.

For recipes that do not require preheating, eliminate step 2.

NOTE: During preheating "P" appears in the *Menu Action Screen Display*. Please do not open door.

When preheating is completed, oven will beep three times and "P END" will appear in the *Menu Action Screen Display*.

3 Place the Food Carefully

in an oven-safe dish on Oven Rack.

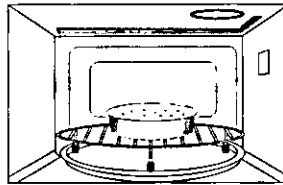

4 Set Baking Time

Using Number Pads. (up to 9 hours 99 minutes)

e.g. 30 minutes

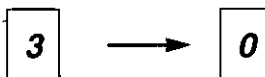

5 Press

Cooking starts. The cooking time in the *Menu Action Screen Display* begins to count down. To recall the selected oven temperature, press **Bake** Pad.

Operation & Hints

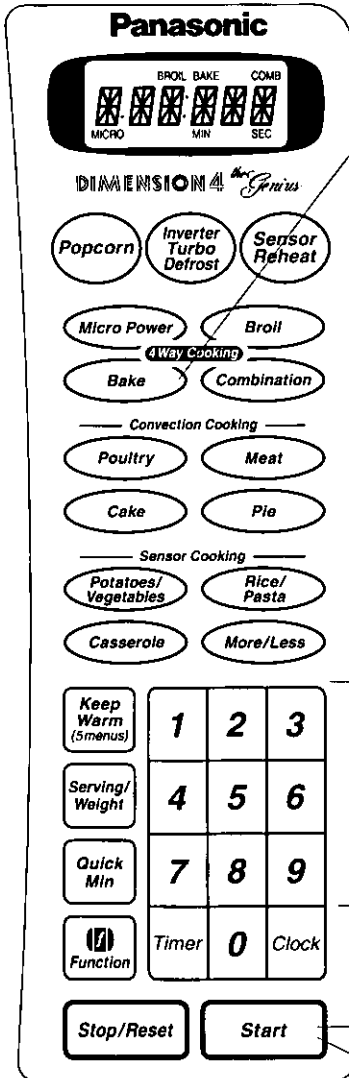

NOTE:

1. If oven door is not opened after preheating, oven will maintain the selected temperature for 30 minutes. After 30 minutes, oven will shut off automatically and beep five times.
2. When selected cooking time is less than one hour, time counts down second by second.
3. When selected cooking time is more than one hour, time counts down minute by minute until 1 hour remains. The timer will then count down second by second.

To Cook on Broil

Use of Accessory:

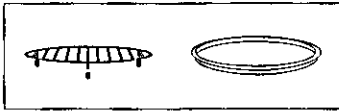

Oven Rack & Ceramic Tray

Most broil items require preheating the oven. Place Oven Rack on Ceramic Tray. Follow these steps.

Operation & Hints

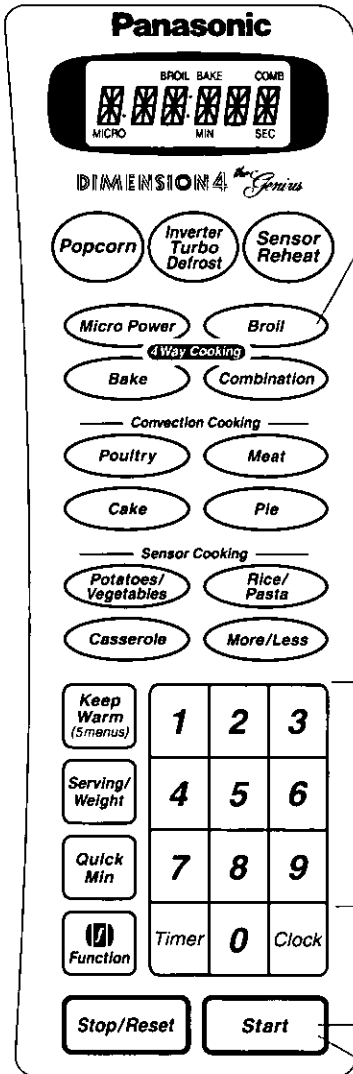

1 Press Broil Pad

2 Press

• Preheating will start.

For recipes that do not require preheating, eliminate step 2.

NOTE: During preheating "P" appears in the *Menu Action Screen Display*. Do not open door during preheating.

When preheating is completed, oven will beep three times and "P END" will appear in the *Menu Action Screen Display*.

3 Place the Food

On spatter shield on broiler pan and carefully place on the Oven Rack. You can purchase most broiler pans from your local stores.

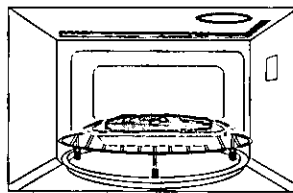

4 Set Broiling Time

using Number Pads.
(up to 99 minutes and 99 seconds)

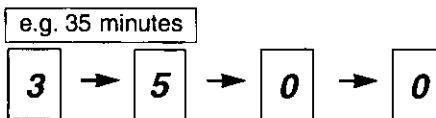

5 Press

• The cooking time in the *Menu Action Screen Display* begins to count down.

NOTE:

1. If oven door is not opened after preheating, oven will maintain the temperature for 30 minutes. After 30 minutes, oven will shut off automatically and beep five times.

To Cook on Combination

Use of Accessory:

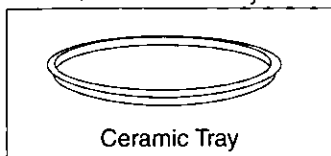

There are 4 combination settings. These settings are automatic, there is no need to set oven temperature or microwave power level. Some combination recipes require preheating. For instructions, follow steps 1 and 2 of the "To Cook on Bake" selection.

1 Place the Food

Open the door and place the food in appropriated sized dish on Ceramic Tray in the oven. Then close the door.

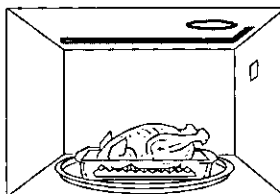

2 Select the Setting

Combination 1, 2, 3, or 4 can be selected.

	Oven Temperature	Micro-wave	Food
1	275°F (130°C)		Beef (Well) Lamb (Well)
2	300°F (150°C)	30 % power	Beef (Rare, Med) Lamb (Med)
3	325°F (160°C)		Pork
4	375°F (190°C)		Chicken or Duck

3 Set Cooking Time

using Number Pads (up to 9 hours 99 minutes).

e.g. 20 minutes

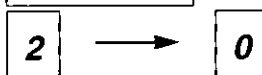

4 Press

◀ Cooking starts. The cooking time in **Menu Action Screen Display** begins to count down.

Operation & Hints

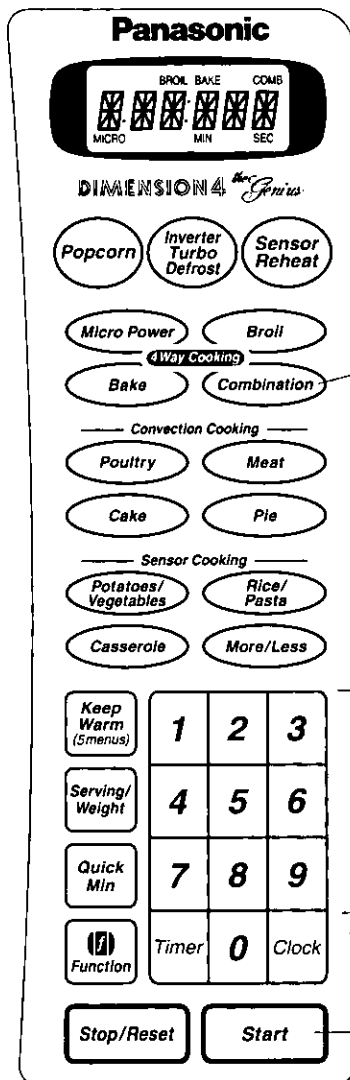

NOTE:

1. When selected cooking time is less than one hour, the time counts down second by second.
2. When selected cooking time is more than one hour, the time counts down minute by minute until only 1 hour remains. The timer will then count down second by second.
3. Use microwaveable and heat-safe dishes.
4. **DO NOT** use plastic wrap or wax paper.
5. Use parchment paper or lid when covering food.

To Use Popcorn Pad

Use of Accessory:

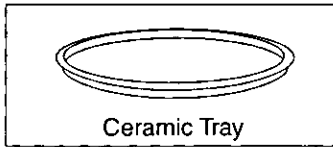

1 Press Popcorn Pad

to select the weight of prepackaged microwave popcorn.

press	Weight
once	3.5 oz. (99 g)
twice	3.0 oz. (90 g)
3 times	1.75 oz. (50 g)

2 Press Start

☛ Cooking time appears in the **Menu Action Screen Display** and begins to count down.

NOTES:

1. Use prepackaged **room temperature** microwave popcorn. Read manufacturers' instructions.
2. Place the bag in oven on Ceramic Tray according to manufacturers' directions.
3. Pop only one bag at a time.
4. When popping multiple bags one right after the other, the cooking times may vary slightly. This does not affect the popcorn results.
5. After popping, open the bag carefully, popcorn and steam are extremely hot.
6. Do not reheat unpopped kernels or reuse bag.
7. **Never** leave oven unattended when popping popcorn.

CAUTION: If pre-packaged popcorn is of a different weight than the recommended weight, do not use the popcorn setting, or inadequate popping or a fire may occur. Follow the manufacturers' instructions.

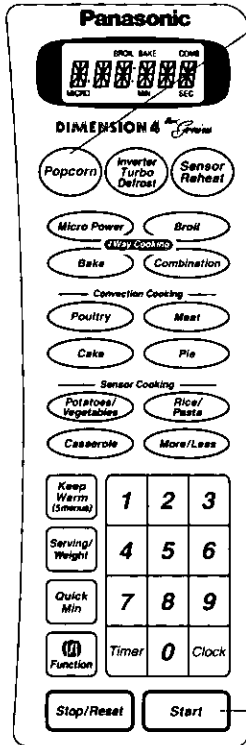

To Use Keep Warm Pad

This feature helps you to keep a certain selection of foods warm for 30 minutes after cooking. (Pie, Gravy, Stew, Casserole or Mashed Potatoes)



Select Category.

Select Serving/Weight.

Press Start.

Keep Warm time appears in the **Menu Action Screen Display** and begins to count down from 30 minutes.

At the end of cooking, five beeps sound and "ENJOY YOUR MEAL" appears in the **Menu Action Screen Display**.

Using Inverter Turbo Defrost Pad

Use of Accessory:

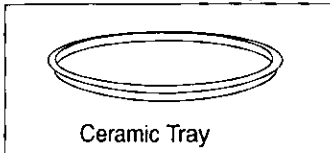

This feature allows you to defrost meat, poultry and seafood by using the weight on the package.

1 Place the Food

Open the food and place the food in appropriated sized dish on Ceramic Tray in the oven. Then close the door.

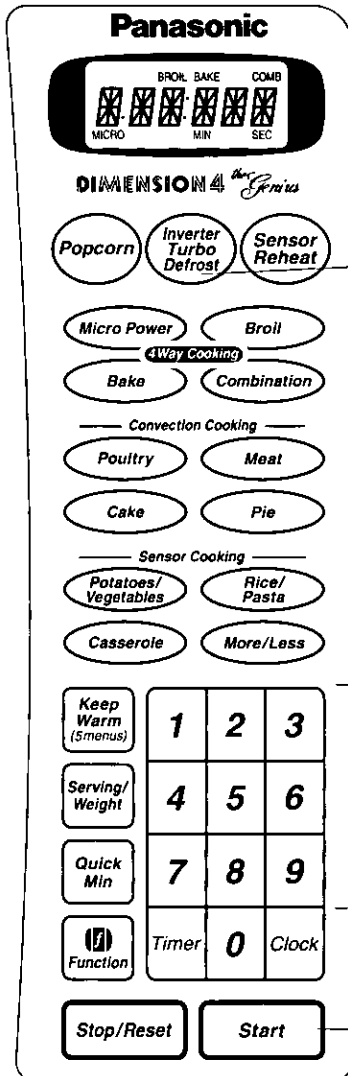
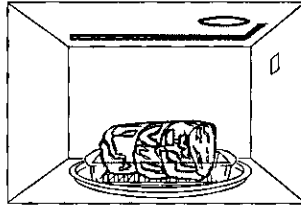

2 Press

3 Set Weight

Weight must be programmed in pounds and tenths of a pound (not ounces).

e.g. 2.6 lbs (1.2 kg)

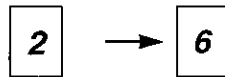

If you wish to use the g / kg, see page 10 "Function".

4 Press

Defrosting time appears in the **Menu Action Screen Display** and begins to count down.

Conversion Chart:

Follow this chart to convert ounces or hundredths of a pound into tenths as a pound. If a piece of meat weighs 1.95 pounds or 1 pound 14 ounces, program 1.9 pounds.

Ounces	Hundredths of a Pound	Tenths of a Pound
0	.96 - .05	0.0
1-2	.06 - .15	0.1
3-4	.16 - .25	0.2
5	.26 - .35	0.3
6-7	.36 - .45	0.4
8	.46 - .55	0.5
9-10	.56 - .65	0.6
11-12	.66 - .75	0.7
13	.76 - .85	0.8
14-15	.86 - .95	0.9

Operation & Hints

NOTE:

- The shape and size of food will determine the maximum weight the oven can accommodate. The recommended maximum weight of meat is **4 lbs (1.8 kg)**; poultry, **6 lbs (2.7 kg)**; and seafood, **3 lbs (1.4 kg)**.
- The oven beeps once during the defrosting cycle to signal that the food needs to be **turned** or **rearranged**. To prevent overdefrosting, thin areas or edges can be shielded with strips of aluminum foil.
- For best results, the minimum recommended weight is **0.5 pound**.
- Stand time or power level may be programmed after **Inverter Turbo Defrost**.

To Use Sensor Reheat/Sensor Cooking

Use of Accessory:

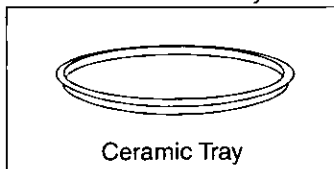

This feature allows you to reheat/cook most of your favourite foods without having to select reheating/cooking times and power levels. The oven does it all automatically.

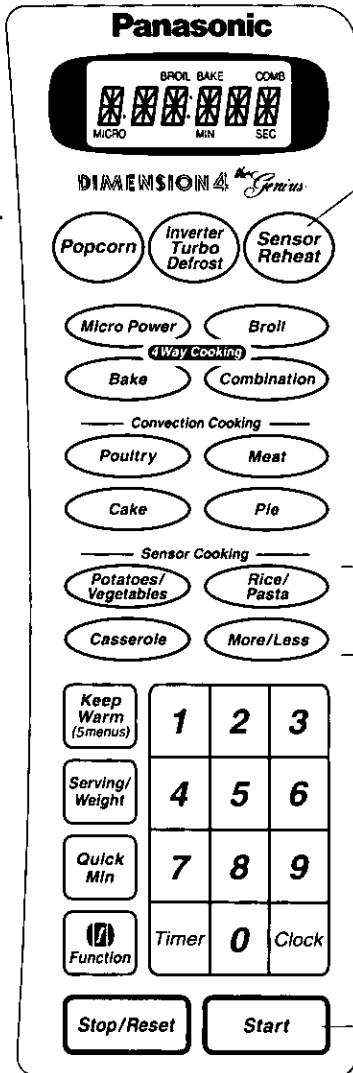

1 Select Category

The *Potatoes/Vegetables*, *Rice/Pasta* and *Casserole* Pads each have 2 - 4 categories. See next page.

More / Less Pads:

Preferences for food doneness vary with each individual. After having used **Sensor Reheat / Sensor Cooking** a few times, you may decide you would prefer your food cooked to a program can be adjusted to cook food for a longer or shorter time.

Press **More / Less** Pad before pressing **Start**.

- 1 tap = More cooking
- 2 taps = Less cooking
- 3 taps = original cooking

2 Press

• Cooking will start.

After the burst of steam is detected by the SENSOR, the remaining cooking time appears in the **Menu Action Screen Display** and begins to count down.

For best results by Sensor, follow these recommendations.

BEFORE Reheating / cooking:

1. The room temperature surrounding the oven should be below 95°F(35°C)
2. Food weight should be between 4 oz (120 g) and 24 oz (680 g).
3. Ceramic Tray and outside of container should be dry.
4. Cover foods loosely but completely, with plastic wrap or place foods in a casserole dish with a proper fitting lid.
5. All foods should be taken from their normal storage place.

DURING Reheating / Cooking:

While "AUTO" is displayed in the **Menu Action Screen Display**, DO NOT open door longer than 1 minute. This causes inaccurate cooking results. Once the timer begins to count down, the oven door may, be opened to stir, turn, shield or add foods.

AFTER Reheating / Cooking:

All foods should have a covered stand time.

To Use Sensor Reheat/Sensor Cooking



DO NOT:

1. Reheat bread and pastry products. Use manual power and time.
2. Reheat raw or uncooked food.
3. Use if oven cavity is warm.
4. Use for beverages.
5. Use for frozen foods.

Food	Starting Temp.	Weight per Serving	Number of Servings
Plate of Food	Refrig.	12-16 oz	1
Meat, Poultry	Refrig.	4-6 oz	1-4
Casseroles	Refrig.	8 oz	1-2
Side dishes	Refrig. or Room	4-6 oz	1-4
Soups, Sauces, Gravies	Refrig.	6-8 oz	1-2

Casseroles - Add 2 to 4 tablespoons of liquid; cover with lid or plastic wrap. Stir when time appears in the Menu Action Screen Display.

Canned foods - Empty contents into casserole dish or serving bowl; cover dish with lid or plastic wrap. After reheating, release plastic wrap and stand.

Plate of food - Arrange food on plate; top with butter, gravy, etc. After reheating, release plastic wrap and stand.

Operation & Hints

SENSOR COOK - HINTS:

	CATEGORY	WEIGHT RANGE	INSTRUCTIONS	COVER	AFTER BEEP
	1 x Potatoes	1 - 4 potatoes 6 - 8 oz (170 - 230 g) each	Pierce several times and place on a microwave safe dish.	NO	Turn over.
	2 x Fresh Vegetables	1/2 - 2 lb (230 - 900 g) weight before peeling, trimming etc.	Add water.	Lid or plastic wrap	Stir or rearrange, if possible.
	3 x Canned Vegetables	15 oz can size	Empty contents into microwave-safe serving bowl.	Lid or plastic wrap	Stir or rearrange.
	4 x Frozen Vegetables	10 - 28 oz (280 - 800 g)	Add 2 tbsp of water. Do not cook with butter or sauce.	Lid or plastic wrap	Stir or rearrange.
	1 x White Rice	Rice--Boiling water 1/2 cup---1 cup 1 cup---2 cups	Place rice with hot water in a microwave-safe casserole dish.	Follow manufacturers' direction.	Stir, if possible.
	2 x Brown Rice	1 1/2 cups-- 3 cups 2 cups---3 1/2 cups			
	3 x Pasta	2 - 8 oz	Place pasta with hot water in a microwave-safe casserole dish.	Lid or plastic wrap	Stir occasionally
	1 x Casserole 1	_____	Use appropriate amount of liquid.	Lid.	Stir occasionally
	2 x Casserole 2	_____			

NOTE: if **Sensor Reheat/Cook** is programmed while the oven cavity is still hot from heater, "HOT" appears in the **Menu Action Screen Display** the fan starts running to cool the cavity. If the cavity is too hot, the **Sensor** will not work properly. After the cavity has cooled, the "HOT" message will disappear and revert to colon or time of day.

Sensor Cooking is successful with the foods and recipes found in the Cookbook and marked with the Symbol **A**. Because of the vast differences in food composition, recipes and charts without the Symbol **A** should be prepared in your microwave oven using the Power and Time setting.

Using Convection Cooking (Weight cook by combination)

Use of Accessory:

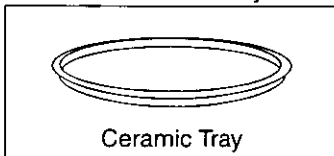

This feature allows you to Roast Beef, Pork or Whole Chicken by setting the weight.
Place food on a microwave roasting rack set in a microwave- and heat-safe dish.

Operation & Hints

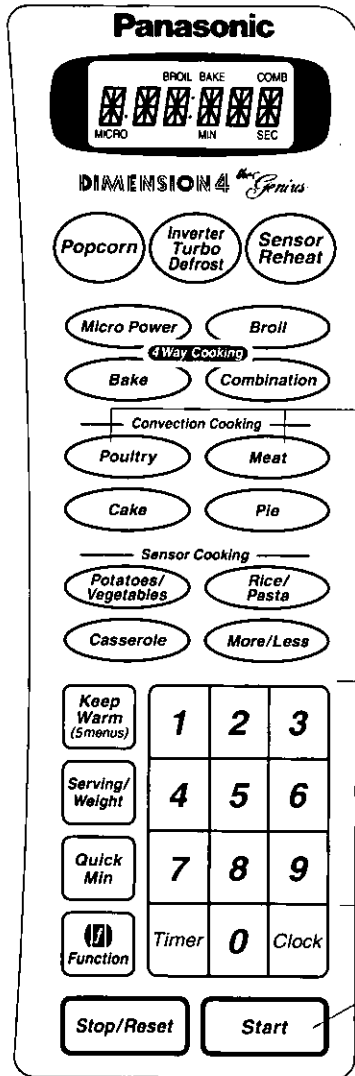

1 Place the Food

Open the door and place the food in dish on Ceramic Tray in the oven. Then close the door.

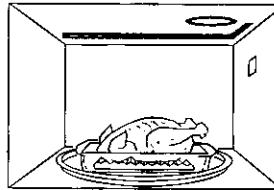

2 Select Category

This pad is subdivided into 4 categories; Chicken Pieces, Whole Chicken, Beef-medium and Pork.

3 Set Weight

e.g. 2.0 lb/kg

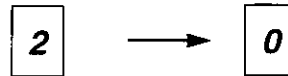

If you wish to adjust the roasting time, press **More / Less** pads (See page 18).

4 Press

- Cooking starts. The cooking time in the **Menu Action Screen Display** begins to count down.

NOTE:

1. These settings are cooked by Auto Combination (Bake and Microwave).
2. When the weight has been selected, the cooking time will be automatically determined.
3. Roasts weighing above or below the recommended weights should be cooked using the Manual Combination.

Auto Combination

CATEGORY	WEIGHT RANGE	INSTRUCTIONS	AFTER BEEP
Chicken Pieces	max. 2 lb (1 kg)	Place skin-side down.	Turn over
Whole Chicken	max. 6 lb (3 kg)	Place breast-side down.	Turn over
Beef - medium	max. 4 lb (2 kg)	Place fat- side down.	Turn over
Pork	max. 4 lb (2 kg)	Place fat-side sown. Pork must reach 170°F(77°C) before serving.	Turn over

Using Convection Cooking (Auto cook by Bake)

Use of Accessory:

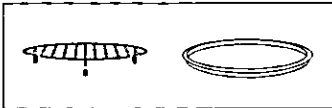

Oven Rack & Ceramic Tray

This feature allows you to bake cake or pie without having to select oven temperature and baking time. Place Oven Rack on Ceramic Tray.

1 Place the Food

Open the door and place the food in dish on Oven Rack on Ceramic Tray. Then close the door.

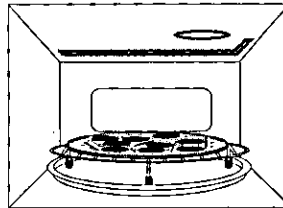

Operation & Hints

2 Select Category

Cake Pad is divided into 2 categories. The **Pie Pad** is divided into 3 categories (see below).

If you wish to adjust the baking time, press **More / Less Pads** (See page 18).

3 Press

• Cooking starts. The cooking time in the **Menu Action Screen Display** begins to count down.

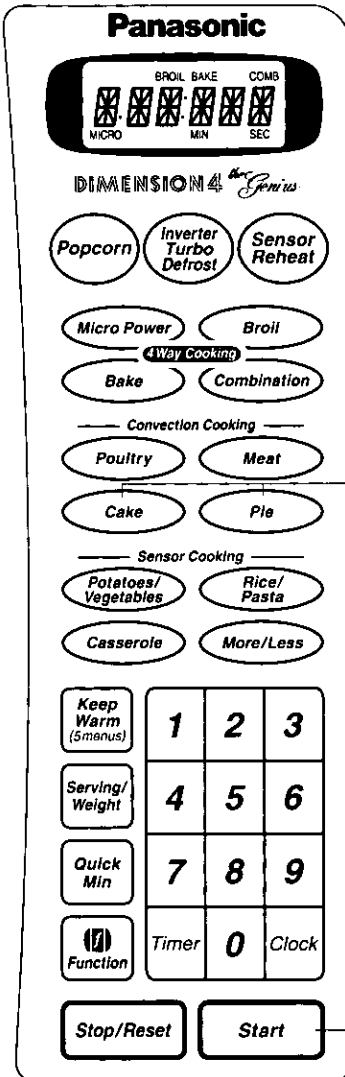

NOTE:

1. These settings are cooked by **Bake**.
2. There is no need to preheat.
3. Metal cookware may be used. Position the dish to be cooked on Oven Rack on Ceramic Tray

PAD	PRESS	CATEGORY
Cake	once	Cake recipes that conventionally bake in less than 35 minutes
	twice	Cake recipes that conventionally bake in 45 minutes to 60 minutes.
Pie	once	Double-crust pies with fresh fruit fillings.
	twice	Double-crust pies that are frozen (weight should not be more than 2 lb 5 oz).
	3 times	Double-crust pies with pre-cooked or canned pie fillings.

- Will not bake chocolate fudge, brownies or fruit cake recipes.
- Do not use frozen pie crust.
- Place frozen pies on a small cookie sheet.

To Use Timer Function

This feature allows you to program a Standing Time after cooking is completed and to program the oven as a minute timer and/or to program delay start.

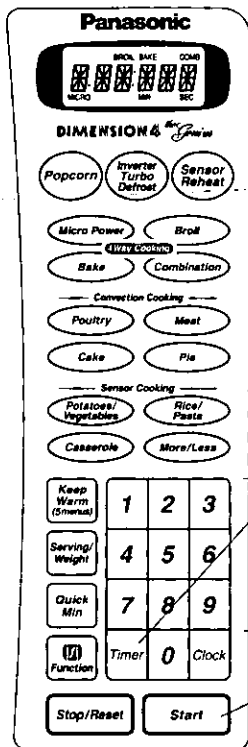

To Use as a Kitchen Timer

1 Press Timer

2 Set Desired Amount of Time

using number pads
(up to 99 minutes and 99 seconds)

3 Press

Time will count down without oven operating.

To Set Stand Time

Set Desired Cooking Program

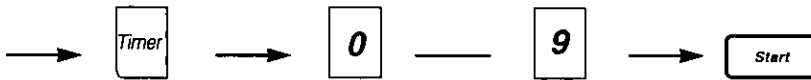

e.g. High 10 min.
(See page 12)

Press.

Set desired amount of stand time.

Press.
Cooking will start.
After cooking, stand time will count down without oven operating

To Set Delay Start

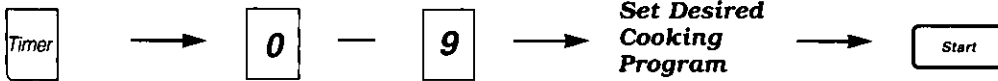

Press

Set desired amount of delayed time.

Set Desired Cooking Program
e.g. High 10 min.
(See page 12)

Press
After completed delayed time, cooking will start.

NOTE:

1. When the first/second stage has finished, a two beep signal is heard. After all the stages have been completed, the oven will beep five times.
2. If oven door is opened during the Stand Time or Kitchen Timer, the time in the **Menu Action Screen Display** will continue to count down.
3. Delay Start cannot be programmed before any Auto Control Function.
This is to prevent the starting temperature of the food from rising before defrosting or cooking begins.
4. Timer can be set up to 99 minutes and 99 seconds.

Before Requesting Service

ALL THESE THINGS ARE NORMAL:

The oven causes interference with my TV.	Some radio and TV interference might occur when you cook with the microwave oven. This interference is similar to the interference caused by small appliances such as mixers, vacuums, hair dryer, etc. It does not indicate a problem with your oven.
The oven lights dim.	When cooking with a power other than P10 - P3, the oven must cycle to obtain the lower power levels. The oven light will dim and clicking noises can be heard when the oven cycles.
Steam accumulates on the oven door and warm air comes from the oven vents.	During cooking, steam and warm air are given off from the food. Most of the steam and warm air are removed from the oven by the air which circulates in the oven cavity. However, some steam will condense on cooler surfaces such as the oven door. This is normal.
I accidentally ran my microwave oven without any food in it.	Running the oven empty for a short time will not damage the oven. However, we do not recommend this to be done.
There are humming and clicking noises from my oven when I cook by Combination.	These noises occur as the oven automatically switches from microwave power to Convection , to create the Combination setting. This is normal.
The oven has an odor and generates smoke when using the Bake, Combination and Broil function.	It is essential that your oven is wiped out regularly particularly after cooking. Any fat and grease that builds up on the roof and walls of the oven will begin to smoke if not cleaned.

PROBLEM	POSSIBLE CAUSE	REMEDY
Oven will not turn on.	The oven is not plugged in securely.	Remove plug from outlet, wait 10 seconds and re-insert.
	Circuit breaker or fuse is tripped or blown.	Reset circuit breaker or replace fuse.
	There is a problem with the outlet.	Plug another appliance into the outlet to check if the outlet is working.
Oven will not start cooking.	The door is not closed completely.	Close the oven door securely.
	Start pad was not pressed after programming.	Press Start pad.
	Another program has already been entered into the oven.	Press Stop/Reset pad to cancel the previous program and program again.
	The program has not been entered correctly.	Program again according to the Operating Instructions.
	Stop/Reset pad has been pressed accidentally.	Program oven again.
The words "DEMO MODE" appear on the screen.	Oven is set at Demo Mode.*	See page10 (To use Function) to turn off Demo Mode.
When the oven is turning on, there is noise coming from Ceramic Tray.	Roller Ring and oven bottom are dirty.	Clean these parts according to Care of Your Oven (see next page).

Maintenance

* DEMO MODE is designed for retail store display.
Cooking and other functions will not operate during Demo Mode.
If it seems there is a problem with the oven, contact an authorized Service Centre.

Care of Your Microwave Oven

BEFORE CLEANING:

Unplug at socket of the oven. If impossible, leave oven door open to prevent oven from accidentally turning on.

AFTER CLEANING:

Be sure to replace Roller Ring and Ceramic Tray in the proper position and press **Stop/Reset** Pad to clear the **Menu Action Screen Display**.

Inside of the oven:

Wipe with a damp cloth. Non caustic oven cleaners may be used if the oven gets very dirty. The use of harsh detergent or abrasive cleaners is not recommended.

NOTE:

Do not use oven cleaners on the top of the oven.

Ceramic Tray:

Remove and wash in warm sudsy water or in a dishwasher. If grease accumulates, clean with a non-abrasive nylon mesh scouring pad and non caustic oven cleaners.

Outside oven surfaces:

Clean with a damp cloth. To prevent damage to the operating parts inside the oven, water should not be allowed to seep into ventilation openings.

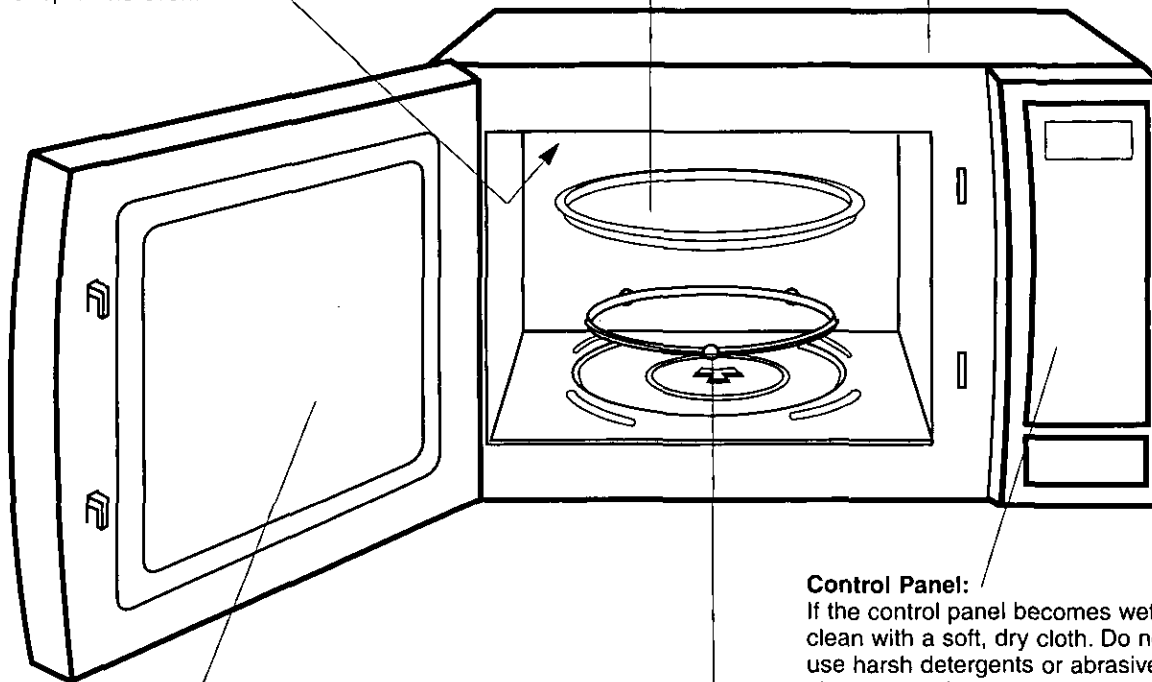

Oven Door:

Wipe with a soft cloth when steam accumulates inside or around the outside of the oven door. This may occur when the oven is operated under high humidity conditions and in no way indicates a malfunction of the unit or microwave leakage.

Control Panel:

If the control panel becomes wet, clean with a soft, dry cloth. Do not use harsh detergents or abrasive cleaners on the control panel.

Roller Ring and oven cavity floor:

Wipe the bottom surface of the oven with mild detergent water or window cleaner and dry. Roller Ring may be washed in mild sudsy water or dishwasher. These areas should be kept clean to avoid excessive noise.

After **Bake/Broil/Combination** cooking, the oven should be cleaned with a soft cloth squeezed in soapy water. If the oven is not cleaned occasionally to eliminate this grease, it can accumulate and cause the oven to SMOKE during use. To avoid smoking, run the oven without food on BROIL for 20 minutes.

Quick Guide to Operation

Before Operation

Feature	How to Operate
To Set Clock (see page 11)	→ — →
To Use Function (see page 10)	→ —
To Use Micro Power and Time Setting (see page 12)	→ — →
To Cook on Bake (see page 13)	→ Press start if preheat required. Select oven temperature. → — →
To Cook on Broil (see page 14)	→ Press start if preheat required. → — →
To Cook on Combination (see page 15)	→ Select the setting. → — →
To Use Popcorn pad (see page 16)	→ Select Serving Weight.
To Use Keep Warm pad (see page 16)	→ Press to select category. → → Press to select quantity. →
To use Turbo Defrost pad (see page 17)	→ — →
To Use Sensor Reheat / Sensor Cooking (see page 18, 19)	→
To Use convection cooking Weight cook (see page 20)	e.g. → — →
To Use convection cooking Auto Cook pads (by Bake) (see page 21)	e.g. →
To Use Quick Min pad (see page 12)	→
To Use as a Kitchen Timer (see page 22)	→ — →
To Set Stand Time (see page 22)	Set desired cooking program. → → — →
To Set Delay Start (see page 22)	→ — → Set desired cooking program. →

Technical Specifications

Power Consumption:	
Microwave	12.8 Amps, 1,500 W
Heater	12.5 Amps, 1,500 W
Output:	
Microwave	1100 W*
Heater	1,400 W
Outside Dimensions:	14 ¹³ / ₁₆ " x 23 ⁷ / ₈ " x 19 ⁵ / ₁₆ "
	376 mm (H) x 606 mm (W) x 491 mm (D)
Oven Cavity Dimensions:	9 ¹ / ₂ " x 16 ¹ / ₄ " x 16 ¹³ / ₁₆ "
	242 mm (H) x 412 mm (W) x 426 mm (D)
Operating Frequency:	2,450 MHz
Built-in Trim Kit:	NN-TK909W (NN-C980W) / NN-TK909 (NN-C980B)
Uncrated Weight:	Approx. 46 lbs (21 kg)

* IEC 705-88 Test procedure

Specifications are subject to change without notice.

As for the voltage requirement, the production year and month, country and serial number, please refer to the identification plate on the microwave oven.

ESPECIFICACIONES TÉCNICAS

Potencia de Consumo:	
Micro-ondas;	12,8 Amps, 1500 W
Calor Emitido;	12,5 Amps, 1500 W
Potencia de Salida:	
Microondas;	1100 W*
Calor Emitido;	1400 W
Dimensiones Exteriores:	376 mm x 606 mm x 491 mm
(Alto x Ancho x Fondo)	14 ¹³ / ₁₆ " x 23 ⁷ / ₈ " x 19 ⁵ / ₁₆ "
Dimensiones Cavidad del Horno:	242 mm x 412 mm x 426 mm
(Alto x Ancho x Fondo)	9 ¹ / ₂ " x 16 ¹ / ₄ " x 16 ¹³ / ₁₆ "
Frecuencia:	2450 MHz
Operación:	NN-TK909W (por NN-C980W)/NN-TK909 (por NN-C980B)
Peso sin Embalaje:	Aprox. 21 kg (46 lbs)

* IEC 705-88 Procedimiento de Prueba

Las especificaciones están sujetas a cambios sin previo aviso.

Panasonic Consumer Electronics Company, Division of Matsushita Electric Corporation of America
One Panasonic Way,
Secaucus, New Jersey 07094

Panasonic Sales Company, Division of Matsushita Electric of Puerto Rico, Inc. ("PSC")
Ave. 65 de Infantería, Km. 9.5
San Gabriel Industrial Park,
Carolina, Puerto Rico 00985

A00034X01AP
F0400-0
Printed in Japan