

PANASONIC NN-E677 Owner's Manual

[Shop genuine replacement parts for PANASONIC
NN-E677](#)

Glass Tray

1. Do not operate the oven without the Roller Ring and Glass Tray in place.
2. Only use the Glass Tray specifically designed for this oven. Do not substitute any other Glass Tray.
3. If Glass Tray is hot, allow to cool before cleaning or placing in water.
4. Do not cook directly on Glass Tray. Always place food in a microwave-safe dish, or on a rack set in a microwave-safe dish.
5. If food or utensil on Glass Tray touches oven walls, causing the tray to stop moving, the tray will automatically rotate in opposite direction. This is normal.
6. Glass tray can rotate in either direction.

See-through Oven Window
with Vapor Barrier (do not remove)

Door Safety Lock System

External Air Vents

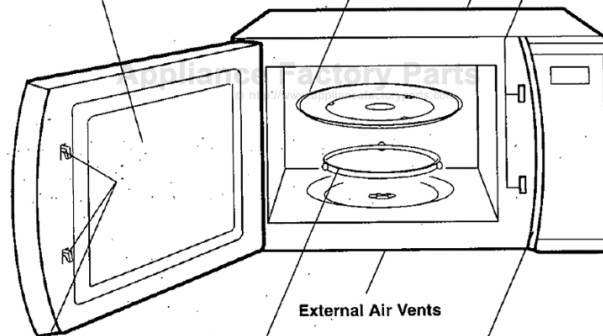

External Air Vents

Roller Ring

1. The Roller Ring and oven floor should be cleaned frequently to prevent excessive noise.
2. The Roller Ring must always be used together with the Glass Tray for cooking.

Identification Plate

Door Safety Lock System

[Find Your PANASONIC Microwave Parts - Select From 742 Models](#)

----- Manual continues below -----

Panasonic®

Operating Instructions

Microwave oven

Model NN-S787/NN-S687/NN-S587

NN-E777/NN-E677/NN-E577

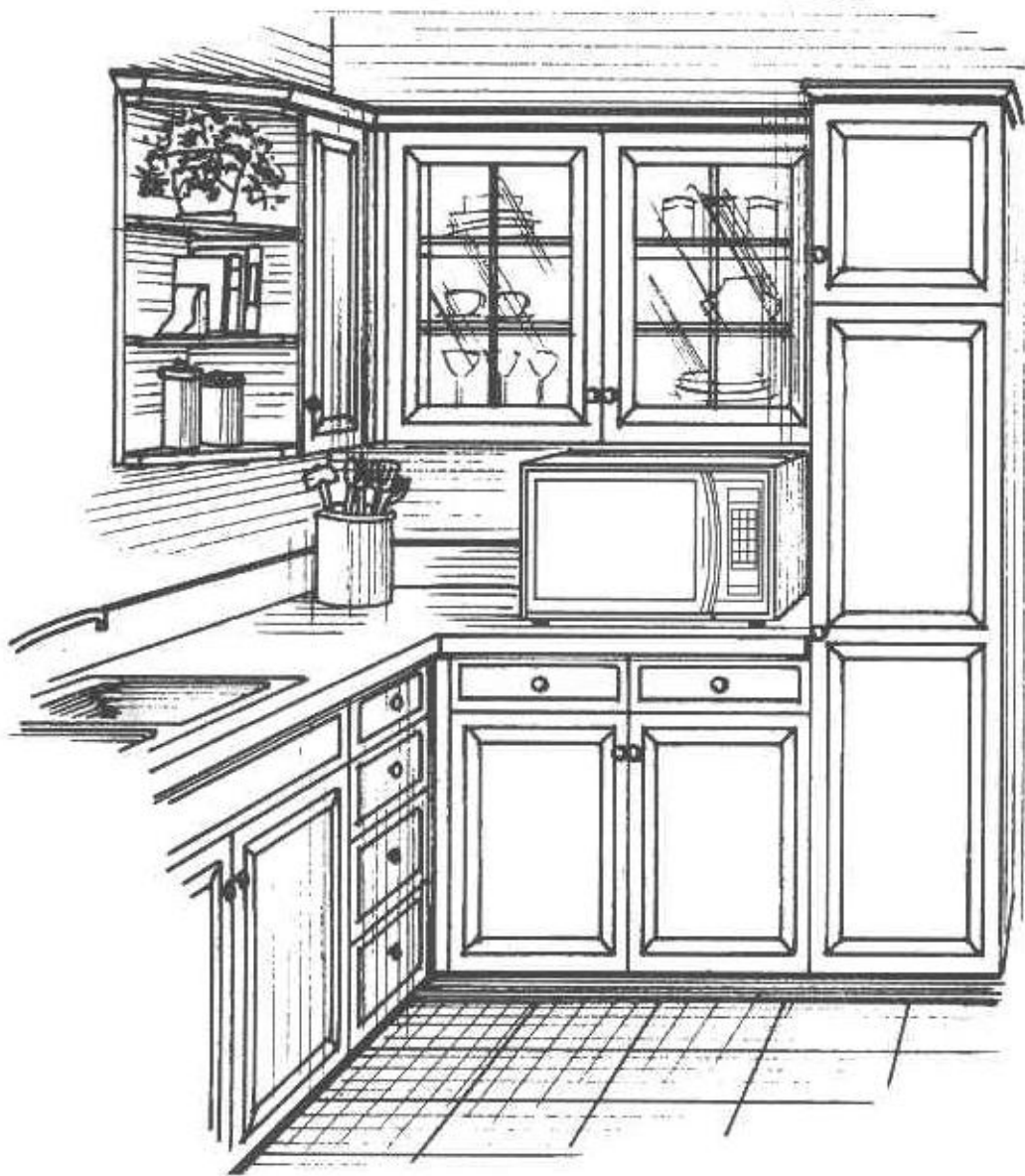

Before operating this oven, please read these instructions completely.

Antes de operar este producto, lea este instructivo en su totalidad.

El manual de instrucciones en español puede ser encontrada en la páginas 32-45.

(Spanish Operating Instructions can be found on pages 32-45.)

Parts order information on page 31.

Thank you for purchasing the Panasonic Microwave Oven.

PRECAUTIONS TO AVOID POSSIBLE EXPOSURE TO EXCESSIVE MICROWAVE ENERGY

- (a) Do not attempt to operate this oven with the door open since open-door operation can result in harmful exposure to microwave energy. It is important not to defeat or tamper with the safety interlocks.
- (b) Do not place any object between the oven front face and the door, or allow soil or cleaner residue to accumulate on sealing surfaces.
- (c) Do not operate the oven if it is damaged. It is particularly important that the oven door close properly and that there is no damage to the:
 - (1) door (bent)
 - (2) hinges and latches (broken or loosened)
 - (3) door seals and sealing surfaces.
- (d) The oven should not be adjusted or repaired by anyone except properly qualified service personnel.

STAPLE YOUR STORE RECEIPT HERE.

Technical Specifications

| | NN-S787/NN-E777 1.5 cu. ft. | NN-S687/NN-E677 1.3 cu. ft. | NN-S587/NN-E577 1.0 cu. ft. |
|--|---|--|---|
| Power consumption: | 13.8 Amps, 1580 W | 13.5 Amps, 1550 W | 13.5 Amps, 1550 W |
| Output: | 1,000 W | 1,000 W | 1,000 W |
| Outside Dimensions: (H x W x D) | 14" x 23 ¹ / ₈ " x 16 ¹ / ₈ " 356 x 595 x 415mm | 12" x 21 ¹ / ₈ " x 16 ¹ / ₈ " 306 x 555 x 425mm | 12" x 20" x 14 ¹ / ₈ " 306 x 510 x 360mm |
| Oven Cavity Dimensions: (H x W x D) | 10 ¹ / ₈ " x 16 ¹ / ₈ " x 15 ¹ / ₈ " 259 x 415 x 385mm | 8 ¹ / ₈ " x 14 ¹ / ₈ " x 15 ¹ / ₈ " 220 x 375 x 395mm | 9" x 13 ¹ / ₈ " x 13 ¹ / ₈ " 229 x 353 x 338mm |
| Operating Frequency: | 2,450 MHz | 2,450 MHz | 2,450 MHz |
| Uncrated Weight: | Approx. 40 lbs (17.9 kg) | Approx. 38 lbs (17.2 kg) | Approx. 34 lbs (15.3 kg) |

The serial number of this product may be found on the right side of the oven door opening. You should note the model number and the serial number of this oven in the space provided and retain this book as a permanent record of your purchase for future reference.

Model No. _____

Serial No. _____

Date of Purchase _____

CONTENTS

Before Operating

| | |
|----------------------------------|---|
| Safety Instructions | 2 |
| Installation Instructions | 3 |
| Grounding Instructions | 3 |
| Practical Hints | 4 |
| Cookware and Utensil Guide | 5 |
| Feature Diagram | 6 |
| Control Panels | 7 |

Operation & Hints

| | |
|---|---------|
| Let's Start to Use Your Oven! | 8 |
| To Use Function | 8 - 9 |
| To Set Clock | 10 |
| To Reheat using Power and Time Setting | 10 |
| Auto Reheat | 16 |
| Sensor Reheat Pad | 13 |
| To Defrost using Power and Time Setting | 10 |
| Auto Defrost Pad | 11 |
| To Cook using Power and Time Setting | 10 |
| Sensor Cooking Pads | 13 - 14 |
| Auto Cook | 15 |
| Popcorn Pad | 16 |
| To Set Timer (Stand Time/Delay Start) | 17 |
| To Use Quick Minute | 16 |

Cooking Guide & Charts

| | |
|------------------------------|---------|
| Food Characteristics | 18 |
| Cooking Techniques | 19 |
| Cooking Charts | |
| Meats | 20 - 21 |
| Poultry | 22 |
| Fish and Seafood | 23 |
| Casseroles | 23 |
| Vegetables | 24 |
| Pasta, Rice and Cereal | 25 |
| Quick Breads and Cakes | 26 |
| Eggs and Cheese | 27 |
| Pies | 27 |
| Microwave Shortcuts | 28 |

Maintenance

| | |
|-----------------------------------|--------------------|
| Part Order Information | 30 |
| Before Requesting Service | 29 |
| Care of Your Microwave Oven | 30 |
| Technical Specifications | Inside Front Cover |
| Quick Guide to Operation | Back Cover |

Manual de instrucciones (Spanish Operating Instructions)

| | |
|--|---------|
| Precauciones | 32 |
| Instrucciones de seguridad | 32 - 33 |
| Instrucciones para Conexión a Tierra | 33 |
| Instrucciones de instalación | 34 |
| Surgerencias Utiles | 35 |
| Panel de Controles | 36 |
| Procedimientos de Operación | 37 - 44 |
| Cuidados de Su Horno de Microondas | 45 |
| Antes de Acudir a Servicio | 45 |

IMPORTANT SAFETY INSTRUCTIONS

Your microwave oven is a cooking device and you should use as much care as you use with a stove or any other cooking device.

When using this electric appliance, basic safety precautions should be followed, including the following:

WARNING—To reduce the risk of burns, electric shock, fire, injury to persons or exposure to excessive microwave energy:

1. Read all instructions before using the appliance.
2. Read and follow the specific "**PRECAUTIONS TO AVOID POSSIBLE EXPOSURE TO EXCESSIVE MICROWAVE ENERGY,**" found on back of the front cover.
3. This appliance must be grounded. Connect only to properly grounded outlet. See "**GROUNDING INSTRUCTIONS**" found on page 3.
4. Install or locate this appliance only in accordance with the installation instructions found on page 3.
5. Do not cover or block any openings on this appliance.
6. Do not store or use this appliance outdoors. Do not use this product near water—for example, near a kitchen sink, in a wet basement, or near a swimming pool, and the like.
7. Use this appliance only for its intended use as described in this manual. Do not use corrosive chemicals or vapors in this appliance. This type of oven is specifically designed to heat, or cook food. It is not designed for industrial or laboratory use.
8. When cleaning surfaces of door and oven that come together on closing the door, use only mild, non-abrasive soaps or detergents applied with a sponge or soft cloth.
9. As with any appliance, **close supervision is necessary** when used by children.
10. Do not operate this appliance if it has a damaged cord or plug, if it is not working properly, or if it has been damaged or dropped.
11. Do not immerse cord or plug in water.
12. Keep cord away from heated surfaces.
13. Do not let cord hang over edge of table or counter.
14. This appliance should be serviced only by qualified service personnel. Contact the nearest authorized service facility for examination, repair or adjustment.
15. Some products such as whole eggs and sealed containers—for example, closed glass jars—may explode and should not be heated in this oven.
16. To reduce the risk of fire in the oven cavity:
 - (a) Do not overcook food. Carefully attend appliance if paper, plastic, or other combustible materials are placed inside the oven to facilitate cooking.
 - (b) Remove wire twist-ties from paper or plastic bags before placing bag in oven.
 - (c) If materials inside the oven should ignite, keep oven door closed, turn oven off, and disconnect the power cord, or shut off power at the fuse or circuit breaker panel.

- (d) Do not use the cavity for storage purposes. Do not leave paper products, cooking utensils, or food in the cavity when not in use.

General Use

1. Do **NOT** tamper with or make any adjustments or repairs to door, control panel housing, safety interlock switches or any other part of the oven. Do **NOT** remove outer panel from oven. Repairs should only be done by a qualified service person.

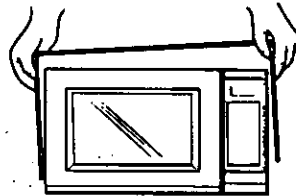

2. Do **NOT** operate the oven empty. The microwave energy will reflect continuously throughout the oven if food or water is not present to absorb energy. This could damage the oven and result in the danger of a fire.

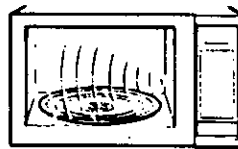

3. Do **NOT** use this oven to heat chemicals or other non-food products. Do **NOT** clean this oven with any product that is labeled as containing corrosive chemicals. **The heating of corrosive chemicals in this oven can cause radiation leaks.**
4. Do **NOT** dry clothes, newspapers or other materials in oven. They may catch fire.
5. Do **NOT** use recycled paper products unless the paper product is labeled safe for microwave oven use. Recycled paper products may contain impurities which may cause sparks and/or fires when used.
6. Do **NOT** use newspapers or paper bags for cooking. Fire can result.
7. Do **NOT** hit or strike control panel. Damage to controls may occur. Fire can result.
8. POT HOLDERS may be needed when cooking. Heat is transferred from the hot food to the cooking container and from the cooking container to the Glass Tray. Glass Tray can be very hot after removing cooking container from oven.
9. Do **NOT** store flammable materials next to, on top of, or in the oven. These could be fire hazards.

SAVE THESE INSTRUCTIONS

For proper use of your oven read remaining safety cautions and operating instructions.

INSTALLATION & GROUNDING INSTRUCTIONS

Examine Your Oven

Unpack oven, remove all packing material, and examine the oven for any damage such as dents, broken door latches or cracks in the door. Notify dealer immediately if oven is damaged. **Do NOT** install if oven is damaged.

Placement of Oven

1. Oven must be placed on a flat, stable surface. For proper operation, the oven must have sufficient air flow. Allow 3 inches (8 cm) of space on both sides of the oven and 1 inch (2.5 cm) of space on top of oven.
 - a. **Do NOT** block air vents.
If they are blocked during operation, the oven may overheat. If the oven overheats, a thermal safety device will turn the oven off. The oven will remain inoperable until it has cooled.
 - b. **Do NOT** place oven near a hot damp surface such as a gas or electric range.
 - c. **Do NOT** operate oven when room humidity is too high.
2. This oven was manufactured for household use only.

Grounding Instructions

This appliance must be grounded. In the event of an electrical short circuit, grounding reduces the risk of electric shock by providing an escape wire for the electric current. This appliance is equipped with a cord having a grounding wire with a grounding plug. The plug must be plugged into an outlet that is properly installed and grounded.

WARNING—Improper use of the grounding plug can result in a risk of electric shock.

Consult a qualified electrician or service person if the grounding instructions are not completely understood, or if doubt exists as to whether the appliance is properly grounded.

If it is necessary to use an extension cord, use only a three wire extension cord that has a three blade grounding plug, and a three slot receptacle that will accept the plug on the appliance. The marked rating of the extension cord should be equal to or greater than the electrical rating of the appliance.

Power Supply

1. A short power-supply cord is provided to reduce the risks resulting from becoming entangled in or tripping over a longer cord.
2. Longer cord sets or extension cords are available and may be used if care is exercised in their use.
3. If a long cord or extension cord is used, (1) the marked electrical rating of the cord set or extension cord should be at least as great as the electrical rating of the appliance, (2) the extension cord must be a grounding-type 3-wire cord, and (3) the longer cord should be arranged so that it will not drape over the countertop or tabletop where it can be pulled on by children or tripped over accidentally.

Wiring Requirements

1. The oven must be on a **SEPARATE CIRCUIT**. No other appliance should share the circuit with the microwave oven. If it does, the branch circuit fuse may blow, or the circuit breaker may trip or the food may cook slower than the times recommended in this manual.
2. The **VOLTAGE** used must be the same as specified on this microwave oven (120V). Using a higher voltage is dangerous and may result in a fire or other accident causing oven damage. Using a lower voltage will cause slow cooking. Panasonic is **NOT** responsible for damage resulting from the use of the oven with other than specified voltage.
3. The oven must be plugged into at least a **20 AMP 120 VOLT, 60 Hz GROUNDED OUTLET**.

Where a standard two-prong outlet is encountered, it is the personal responsibility and obligation of the consumer to have it replaced with a properly grounded three-prong outlet.



4. A **TEMPORARY CONNECTION** with a two-prong adapter may be made where **LOCAL CODES PERMIT** it. Unless the cover screw is grounded through the house wiring, attaching the adapter grounding plate to the cover screw will not ground the oven. If there is any doubt that the cover screw is grounded, have it checked by an electrician.

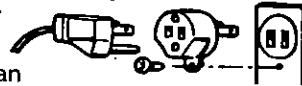

Radio Interference

1. Operation of the microwave oven may cause interference to your radio, TV or similar equipment.
2. When there is interference, it may be reduced or eliminated by taking the following measures:
 - a. Clean door and sealing surfaces of the oven. (See Care of Your Microwave Oven.)
 - b. Place the radio, TV, etc. away from the microwave oven as far as possible.
 - c. Use a properly installed antenna to obtain stronger signal reception.

Follow These Safety Precautions When Cooking in Your Oven

1) HOME CANNING / DRYING FOODS / SMALL QUANTITIES OF FOODS

- Do not use your oven for home canning or the heating of any closed jar. Pressure will build up and the jar may explode. Your oven cannot maintain the food at the proper canning temperature. Improperly canned food may spoil and be dangerous to consume.
- Small quantities of food or foods with low moisture content can dry out, burn or catch on fire.
- Do not dry meats, herbs, fruits or vegetables in your oven.

IMPORTANT

Proper cooking depends on time set and weight of food. If you use a smaller portion than recommended and cook at the time for the recommended portion, fire can result.

If a fire occurs, turn the oven off and leave the oven door closed. Disconnect the power cord or shut off power at the fuse or circuit breaker panel.

2) POPCORN

Popcorn must be popped in a microwave oven corn popper. Microwave popcorn which pops in its own package is also available. Follow popcorn manufacturers' directions and use a brand suitable for the wattage of your microwave oven. Never leave oven unattended when popping popcorn. Allow the popcorn bag to cool before opening it. To prevent steam burns, always open the bag away from your face and body.

CAUTION:

When using pre-packaged microwave popcorn, follow recommended package instructions.

Check package weight before using the popcorn pad. Set the oven for the weight of the popcorn package. (see page 16)

If these instructions are not followed, the popcorn may not pop adequately or may ignite and cause a fire.

3) DEEP FAT FRYING

- Do not attempt to deep fat fry in your microwave oven. Cooking oils may burst into flames and may cause damage to the oven and perhaps result in burns. Microwave utensils may not be able to withstand the temperature of the hot oil, and could shatter.

4) EGGS

- Do not heat eggs in their shell in a microwave oven. Pressure will build up and the eggs will explode.

5) FOODS WITH NONPOROUS SKINS

- Potatoes, apples, egg yolks, whole squash and sausages are examples of foods with nonporous skins. These types of foods must be pierced before Microwave cooking to prevent their bursting.
- Use fresh potatoes for baking and cook until just done. Overcooking causes dehydration and may cause a

fire. Use recommended weights or fire may occur.

6) LIQUIDS

- Heated liquids can erupt if not mixed with air. Do not heat liquids in your microwave oven without first stirring.

7) GLASS TRAY / COOKING UTENSILS / FOIL

- Cooking utensils get hot during Microwaving. Use potholders when removing utensils from the oven or when removing lids or plastic wrap covers from cooking utensils to avoid burns.
- The glass tray will get hot during cooking. It should be allowed to cool before handling or before paper products, such as paper plates or microwave popcorn bags, are placed in the oven for microwave cooking.
- When using foil, skewers, warming rack or utensils made of metal in the oven, allow at least 1-inch of space between metal material and interior oven walls. If arcing occurs (sparking) remove metal material (skewers etc.) and/or transfer to a non-metallic container.
- Dishes with metallic trim should not be used, as arcing may occur.

8) PAPER TOWELS / CLOTHS

- Do not use paper towels or cloths which contain a synthetic fiber woven into them. The synthetic fiber may cause the towel to ignite.
- Do not use paper bags or recycled paper products in the microwave oven.

9) BROWNING DISHES / OVEN COOKING BAGS

- Browning dishes or grills are designed for microwave cooking only. Always follow instructions provided by the manufacturer. Do not preheat browning dish more than 8 minutes.
- If an oven cooking bag is used for Microwave cooking, prepare according to package directions. Do not use a wire twist-tie to close bag.

10) THERMOMETERS

- Do not use a conventional meat thermometer in your oven. Arcing may occur.

11) BABY FORMULA / FOOD

- Do not heat baby formula or food in the microwave oven. The glass jar or surface of the food may appear warm while the interior can burn the infant's mouth and esophagus.

12) REHEATING PASTRY PRODUCTS

- When reheating pastry products, check temperature of any fillings before eating. Some foods have fillings which heat faster and can be extremely hot while the surface remains warm to the touch (ex. jelly donuts).

13) GENERAL OVEN USAGE GUIDELINES / OVEN DOOR

- Do not use the oven for any reason other than the preparation of food.
- Do not leave oven unattended while in use.

Cookware and Utensil Guide

| ITEM | MICROWAVE | COMMENTS |
|--|---------------------------------|---|
| Aluminum Foil | Yes for Shielding only | Small strips of foil can be molded around thin parts of meat or poultry to prevent overcooking. Arcing can occur if foil is too close to oven wall or if too much foil is used. |
| Browning Dish | Yes | Browning dishes are designed for microwave cooking only. Check browning dish information for instructions and heating chart. Do not preheat for more than 8 minutes. |
| Brown paper bags | No | May cause a fire in the oven. |
| Dinnerware Microwave-Safe only | Yes | Check manufacturers' use and care directions for suitability for microwave heating. Some dinnerware may state on the back of the dish, "Oven-Microwave Proof." |
| Disposable polyester Paperboard Dishes | Yes | Some frozen foods are packaged in these dishes. Can be purchased in grocery stores. |
| Fast Food Carton with Metal Handle | No | May cause arcing. |
| Frozen Dinner Tray Metal | Yes | Frozen dinners may be heated in foil tray, if tray is less than ¾-inch (2 cm) high. Place foil tray in center of oven. Leave at least 1-inch (2.5 cm) space between foil tray and oven walls. Heat only 1 foil tray in the oven at a time. For containers more than ¾-inch (2 cm) deep, remove food and place in a similar size microwave-safe container. |
| Microwave-safe | Yes | |
| Glass Jars | Yes | Remove lid. Heat food until just warm. Most glass jars are not heat resistant. |
| Glassware Heat Resistant Oven Glassware and Ceramic, only | Yes | Ideal for microwave cooking and browning. |
| Metal Twist Ties | No | They may cause arcing which could cause a fire in the oven. |
| Oven Cooking Bag | Yes | Follow manufacturers' directions. Close bag with the nylon tie provided, a strip cut from the end of the bag, or a piece of cotton string. Do not close with metal twist tie. Make six ½-inch (1 cm) slits by closure. |
| Paper Plates & Napkins | Yes | Use to warm cooked foods, and to cook foods that require short cooking times such as hot dogs. |
| Paper Towels & Napkins | Yes | Use to warm rolls and sandwiches by microwave. |
| Plastic Microwave-Safe only Cookware and Storage Dishes | Yes | Should be labeled, "Suitable for microwave heating." Check manufacturers' directions for recommended uses. Some microwave-safe plastic dishes are not suitable for cooking foods with high fat content. |
| Plastic Foam Cups | Yes | Plastic foam will melt if foods reach a high temperature. Use to bring foods to a low serving temperature. |
| Plastic Wrap | Yes | Use to cover food during cooking to retain moisture. |
| Straw, Wicker, Wood | Yes | Use only for short term reheating. Use to bring foods to a low serving temperature. |
| Thermometers Microwave-safe only Conventional | Yes No | Use only microwave-safe meat and candy thermometers. Not suitable for use in microwave oven. |
| Wax paper | Yes | Use as a cover to prevent spattering and to retain moisture. |

TO TEST A CONTAINER FOR SAFE MICROWAVE OVEN USE: Fill a 1 -cup glass measure with water and place it in the microwave oven along with the container to be tested; **heat one minute at HIGH.** If the container is microwave oven-safe, it should remain comfortably cool and the water should be hot. If the container is hot, it has absorbed some microwave energy and should not be used. This test cannot be used for plastic containers.

Feature Diagram

Glass Tray

1. Do not operate the oven without the Roller Ring and Glass Tray in place.
2. Only use the Glass Tray specifically designed for this oven. Do not substitute any other Glass Tray.
3. If Glass Tray is hot, allow to cool before cleaning or placing in water.
4. Do not cook directly on Glass Tray. Always place food in a microwave-safe dish, or on a rack set in a microwave-safe dish.
5. If food or utensil on Glass Tray touches oven walls, causing the tray to stop moving, the tray will automatically rotate in opposite direction. This is normal.
6. Glass tray can rotate in either direction.

See-through Oven Window
with Vapor Barrier (do not remove)

Door Safety Lock System

External Air Vents

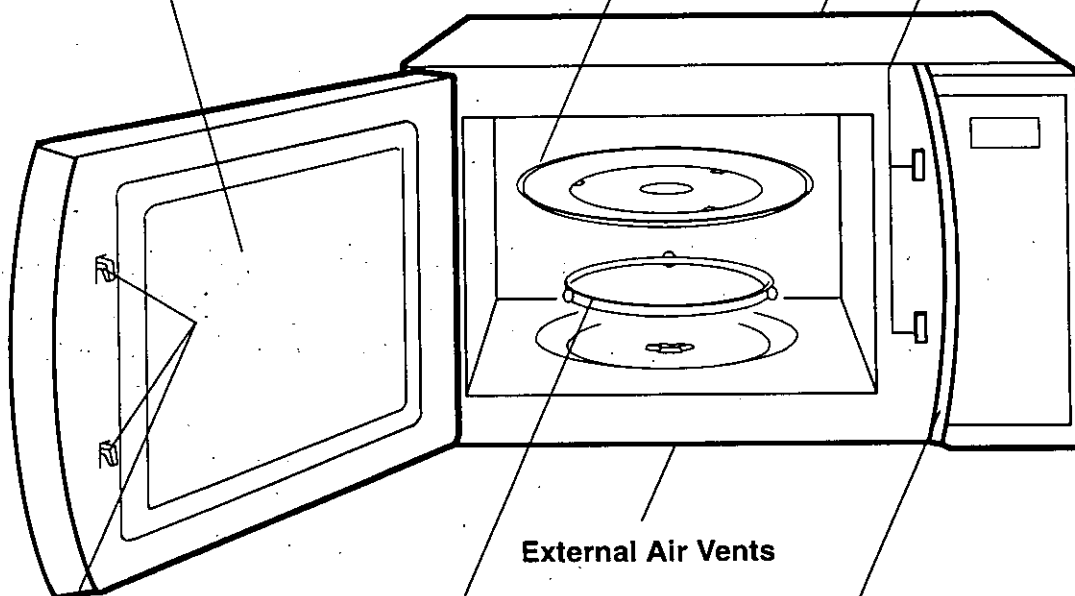

External Air Vents

Roller Ring

1. The Roller Ring and oven floor should be cleaned frequently to prevent excessive noise.
2. The Roller Ring must always be used together with the Glass Tray for cooking.

Identification Plate

Door Safety Lock System

Control Panels

NN-S787/NN-S687/NN-S587

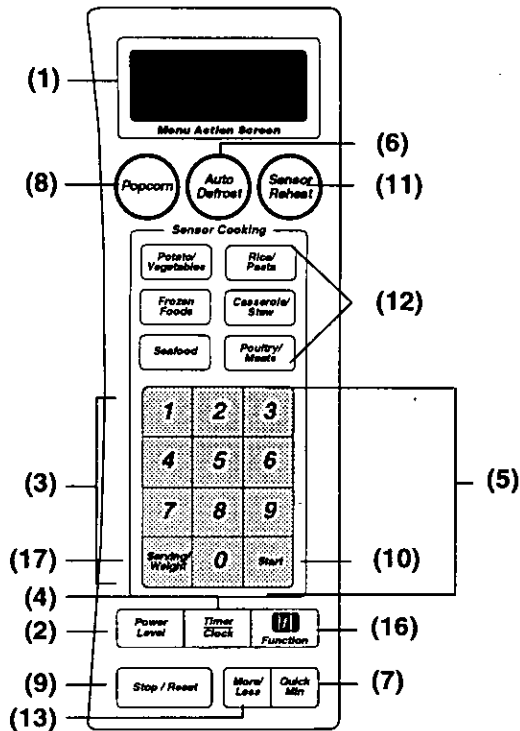

- (1) **Menu Action Screen**
Step by step instructions scroll for easy operation.
- (2) **Power Level Pad** (☛page 10)
- (3) **Number Pads**
- (4) **Timer/Clock Pad** (☛page 10, 11)
- (5) **Cook Action Display**
This totally unique feature of your PANASONIC guides you through the entire cooking process with its illuminated INTERACTIVE CONTROL PANEL. Once a pad has been selected, the COOK ACTION DISPLAY will prompt you to the NEXT step until cooking starts.
- (6) **Auto Defrost Pad** (☛page 12)
- (7) **Quick Min Pad** (☛page 16)
- (8) **Popcorn Pad** (☛page 16)
- (9) **Stop/Reset Pad**
Before cooking: One tap clears your instruction.
During cooking: One tap temporarily stops the cooking process. Another tap cancels all your instructions and time of day or colon appears on the screen.
- (10) **Start Pad**
One tap allows oven to begin functioning. If door is opened or **Stop/Reset Pad** is pressed once during oven operation, **Start Pad** must again be pressed to restart oven.
- (11) **Sensor Reheat Pad** (☛page 18)
- (12) **Sensor Cooking Pads** (☛page 18-19)
- (13) **More/Less Pad** (☛page 18)
One tap allows you to add to the Sensor cooking time. Two taps allows you to program less time when using the Sensor cook pads.

NN-E777/NN-E677/NN-E577

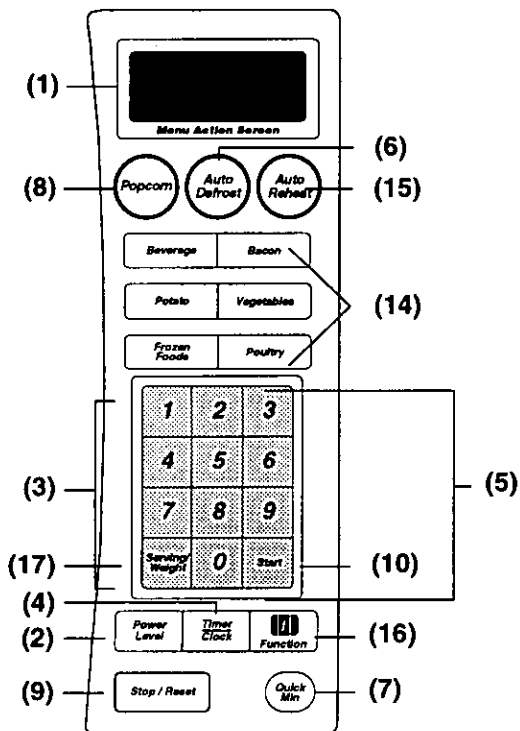

- (14) **Auto Cook Pads** (☛page 15)
- (15) **Auto Reheat Pad** (☛page 16)
- (16) **Function Pad** (☛page 8-9)
- (17) **Serving/Weight Pad** (☛page 15)

Prompters:
When pads are pressed, a beep sound is heard and the corresponding letter or word(s) appear and roll across the **Menu Action Screen** (either the **Beep Sound** or screen may be disabled using the **Function Pad**). If a pad is pressed and no beep is heard, the unit has not or cannot accept the instruction. As each pad is pressed the corresponding word(s) roll across the screen. Words will automatically appear to prompt user to perform the next step. It is not necessary to wait for the words to appear before pressing pads for the next step. A two beep sound is usually heard between stages.

Let's Start to Use Your Oven!

1 Plug in



Plug into a properly grounded electrical outlet. "WELCOME TO PANASONIC REFER TO OPERATING INSTRUCTIONS BEFORE USE" scrolls across the Menu Action Screen.

2 Place a cup of water in the oven

Open the door and place a cup of water on the Glass Tray in the oven. Then close the door.

3 Select Power Level

e.g. MEDIUM Power — Press Power Level Pad four times (see page 10 for chart)

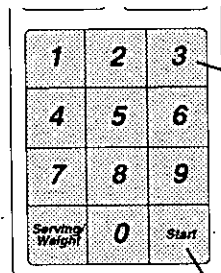

4 Set Cooking Time using number pads

e.g. 1 minute 30 seconds







5 Press Start

► The time in the Menu Action Screen will count down.

A unique feature of your PANASONIC 1000w microwave oven is the FUNCTION pad. The initial settings of your microwave are LANGUAGE = ENGLISH; WEIGHT = LB, WORD SPEED = MEDIUM, MENU ACTION SCREEN = ON, CHILD LOCK = OFF, BEEP = ON, REMINDER BEEP = OFF, DAYLIGHT SAVING = OFF, CLOCK = ON, DEMO MODE = OFF. To change any setting, see page 9 (FUNCTION PAD) for other options.

To Use Function Pad

| | |
|---|---|
| 1)  | Press: FUNCTION. Menu Action Message is "Select Function 0 through 9, 1--LANGUAGE CHOICE --- etc". Number pad flashes. |
| 2) Select a number (0-9) Ex. CHILD LOCK is 5 | Press: Menu Action Message is "5 -- CHILD LOCK ON/OFF ON -- PRESS 1 OFF -- PRESS 2" Numbers  &  flash. |
| 3) Select  or  on off | Press: Either number. Your selection is now part of the operating system. You can change it any time. |
| 4) Continue until you have completed your selections. | See page 9 for other options. |

Functions

This unique feature of your PANASONIC microwave oven allows you to establish the initial non-cooking features of your oven such as CHILD LOCK, WORD SPEED, LANGUAGE CHOICE (ENGLISH, SPANISH OR FRENCH), plus many more. See below.



| | |
|----------|--|
| 1 | <p>LANGUAGE CHOICE The oven has English, French and Spanish display. The display appears in English when you plug-in.</p> <p>1 ENGLISH → Display appears in English. 2 FRANCAIS → Display appears in French. 3 ESPANOL → Display appears in Spanish.</p> |
| 2 | <p>Lb/KG CHOICE The oven has both imperial and metric weight measurements. The oven displays the weight in imperial when you plug it in.</p> <p>1 Lb → Weight can be set in lb/oz. 2 KG → Weight can be set in g/kg.</p> |
| 3 | <p>WORD SPEED The speed of word scrolling in the display window can be quickened or slowed down.</p> <p>1 QUICK → Words scroll quickly. 2 MEDIUM → Scrolling speed reverts to initial setting. 3 SLOW → Words scroll slowly.</p> |
| 4 | <p>MENU ACTION ON/OFF MENU ACTION SCREEN helps you to program your oven by prompting the next step to be taken. When you become familiar with your oven, the prompting can be turned off.</p> <p>1 ON → Prompting Guide will reappear. 2 OFF → Prompting Guide will not appear.</p> |
| 5 | <p>CHILD LOCK ON/OFF The oven has Child Safety Lock feature which prevents use by children.</p> <p>1 ON → Child Lock has been set and operation will not be accepted. 2 OFF → Child Lock has been cancelled.</p> |
| 6 | <p>BEEP ON/OFF If you wish to have the oven operate with no beep, it can be eliminated.</p> <p>1 ON → Beep sound will activate. 2 OFF → Beep sound will not be heard.</p> |
| 7 | <p>REMINDER BEEP ON/OFF A reminder beep works to remind you to remove the food from the oven after the completion of cooking. It will occur every few seconds.</p> <p>1 ON → Reminder beep will work. 2 OFF → Reminder beep will not work.</p> |
| 8 | <p>DAYLIGHT SAVING ON/OFF</p> <p>1 ON → Time of day will advance one hour. 2 OFF → Time of day revert to original setting.</p> |
| 9 | <p>CLOCK ON/OFF Clock display can be turned off.</p> <p>1 ON → Clock display will appear in the display window. 2 OFF → Clock display will not appear in the display window. Time of day will not be lost while the display is off.</p> |
| 0 | <p>DEMO MODE ON/OFF Demo mode is designed for retail store display. In this mode, the oven can be demonstrated with no power in the oven.</p> <p>1 ON → The oven will be in demo mode. 2 OFF → The oven will be out of demo mode.</p> |

Power & Time Setting

1 Select Power Level



| Press | Power Level | % Power |
|---------|-------------|---------|
| once | HIGH | 100% |
| twice | DEFROST | 30% |
| 3 times | MEDIUM-HIGH | 70% |
| 4 times | MEDIUM | 55% |
| 5 times | MEDIUM-LOW | 30% |
| 6 times | LOW | 10% |

When selecting **HIGH** Power, you can start from step 2.
MENU ACTION MESSAGE is " - - - SET TIME".
(Number pad flashes.)

2 Set Cooking Time

(Up to 99 minutes and 99 seconds) e.g. 12 minutes
Number pad flashes until you enter time.



3 START Flashes



MENU ACTION MESSAGE is " - - - PRESS START". If the door is opened "CLOSE DOOR".
➤ Cooking will start. The time in the Menu Action Screen will begin to count down.

To recall the selected power level during cooking, press Power Level Pad.

For 2 or 3 stage cooking, repeat above steps 1 and 2 before pressing Start Pad.

At the end of cooking, MENU ACTION MESSAGE IS "ENJOY YOUR MEAL".

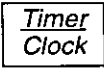
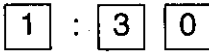
To Set Clock

| | |
|--|--|
| 1.  | PRESS twice for CLOCK. MENU ACTION MESSAGE is "SET TIME : ". Number pad flashes. |
| 2. SET TIME OF DAY (ex. 1:30)  | MENU ACTION MESSAGE is " 1:30 -- PRESS CLOCK PAD". |
| 3.  | Press once. Menu Action Screen displays time of day (clock is a 12 hour clock). |

Timer Function

This feature allows you to program a standing time after cooking is completed and to program the oven as a minute timer and/or to program delay start.

To Use as a Timer

1 Press Timer

PRESS once for **TIMER**. MENU ACTION MESSAGE is "TIMER -- SET TIME" (up to 99 min & 99 seconds). Number pad flashes.

2 Set desired amount of Time

Example: Set the time for 15 minutes using flashing number pad



MENU ACTION MESSAGE is "TIMER 15 min 00 sec -- PRESS START". **Start** flashes.

3 Press Start

Display counts down without oven operating. Five beeps will normally sound at the end (see **FUNCTION** pad for options). MENU ACTION MESSAGE is "ENJOY YOUR MEAL".

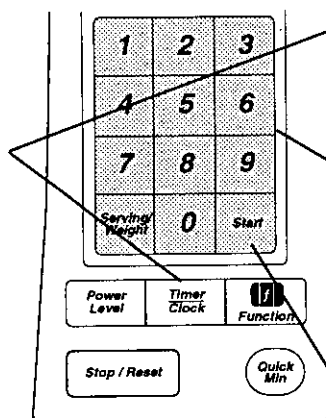

To Set Stand Time

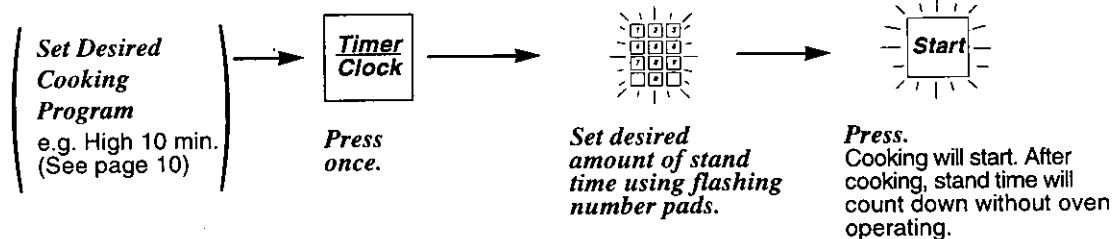

To Set Delay Time

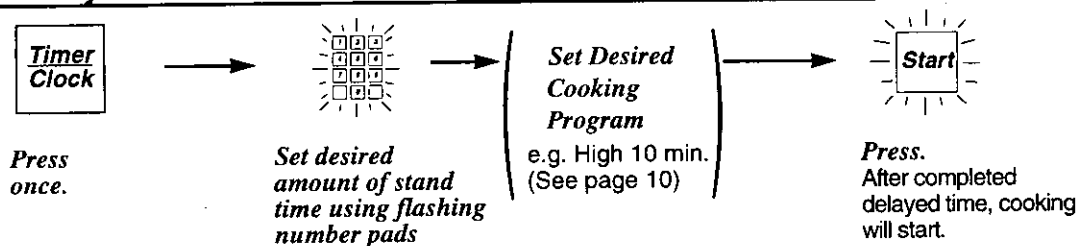

NOTE:

1. When the first/second stage has finished, a two beep signal is heard. After all the stages have been completed, the oven will beep five times.
2. If oven door is opened during the Stand Time of Kitchen Timer, the time in the display window will continue to count down.
3. Delay Start cannot be programmed before any Auto Control Function. This is to prevent the starting temperature of the food from rising before defrosting or cooking begins. A change in the starting temperature could cause inaccurate cooking results.
4. Timer can be set up to 99 minutes and 99 seconds.

Auto Defrost

This feature allows you to defrost meat, poultry and seafood by weight without setting time.



1 Press Auto Defrost Pad

MENU ACTION MESSAGE is "AUTO DEFROST --SET WEIGHT". If you have selected the weight system of lbs/oz, "LB OZ" will appear. If you have selected Kg as the weight system, "kg" will appear.

Number pads flash.

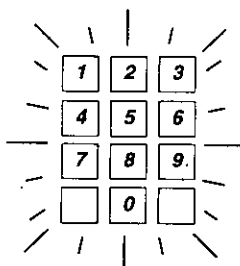

2 Weight of Frozen Food

Enter weight using number pads.

ex. 2.5 lbs. is 2 lbs. 8 oz. (see conversion chart below)

or metric
 lb. oz. 2.5 kg
 .

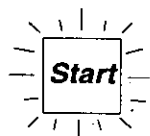

3 START Flashes

After weight has been entered, **Start** flashes.



4 Press START

Defrost time will display and count down.

Conversion Chart

Follow this chart to convert tenths of a pound into ounces. If a piece of meat weighs 1.9 pounds, program 1 pound 14 ounces.

| Tenths of a Pound | Ounces |
|-------------------|---------|
| 0.0 | 0 |
| 0.1 | 1 - 2 |
| 0.2 | 3 - 4 |
| 0.3 | 5 |
| 0.4 | 6 - 7 |
| 0.5 | 8 |
| 0.6 | 9 - 10 |
| 0.7 | 11 - 12 |
| 0.8 | 13 |
| 0.9 | 14 - 15 |

NOTE:

1. The shape and size of the food will determine the maximum weight the oven can accommodate. The recommended **maximum weight of meat is 4 lbs. (1.8 kg); poultry, 6 lbs. (2.7 kg) and seafood, 3 lbs. (1.4 kg).**
2. The oven beeps once during the defrosting cycle to signal that the food needs to be **turned or rearranged**. To prevent overdefrosting, thin areas of edges can be shielded with strips of aluminum foil.
3. For best results, the minimum recommended weight **8 oz. (220 g).**
4. Stand time or power level may be programmed after Auto Defrost.

Defrosting Tips & Techniques

1. Freeze meats, poultry and fish in packages with **only 1 or 2 layers** of food. Place wax paper between layers.
2. **Package** in heavy-duty plastic wraps, bags or freezer paper.
3. **Remove as much air** as possible.
4. Wrap should be snug against food, sealed securely and labeled.
5. **Remove wrapper** to prevent holding steam and juice. **Juice of food** can get hot and cause the outer surface or bottom of the food to cook; set the food on a microwave roasting rack and drain liquid during defrosting.
6. **Place meat in an appropriate size dish.**
7. **Place roast fat-side down** and **whole poultry breast-side down** on a microwave roasting rack in a dish.
8. Place small items on a microwave roasting rack in a dish.
9. **Large roasts** and **whole poultry** may still be icy in center after defrosting, allow to stand in the refrigerator covered with plastic wrap (see chart below).
10. Fish and seafood should be slightly icy after defrosting, allow to stand and rinse under cold water for 2-3 minutes.
11. Defrosted items in 2 layers should be **rinsed separately** or **have a longer stand time.**



| FOOD | DEFROST TIME (min. per pound) | DURING DEFROSTING | AFTER DEFROSTING | |
|---|----------------------------------|---|-------------------|-------|
| | | | Stand Time | Rinse |
| Fish and Seafood [up to 3 lb. (1.5 kg)] | | | | |
| Crabmeat | 12 to 14 | Break apart | 5 min. | NO |
| Fish Steaks | 6 to 10 | Turn over | | YES |
| Fish Fillets | 6 to 8 | Turn over/Rearrange | | |
| Sea Scallops | 14 to 16 | Break apart/Remove defrosted pieces | | |
| Shrimp medium | 8 to 10 | Break apart/Remove defrosted pieces | | |
| Whole fish | 10 to 12 | Turn over | | |
| Meat | | | | |
| Ground Meat | 8 to 10 | Turn over/Remove defrosted portion/Shield edges | 10 min. | NO |
| Roasts [2½ - 4 lb. (1.2 - 2 kg)] | 8 to 12 | Turn over/Shield ends and defrosted surface | 30 min. in refrig | |
| Chops/Steak | 8 to 10 | Separate/Turn over/Rearrange | 5 min. | |
| Ribs/T-bone | 8 to 10 | Turn over/Shield | | |
| Stew Meat | 10 to 12 | Break apart/Shield | | |
| Liver (thin sliced) | 8 to 10 | Drain liquid/Turn over/Separate pieces | | |
| Bacon | 4 to 6 | Turn over | | |
| Poultry | | | | |
| Chicken, Whole [up to 3 lb. (1.5 kg)] | 6 to 10 | Turn over 2 or 3 times/Shield defrosted parts | 20 min. in refrig | YES |
| Cutlets | 6 to 8 | Turn over | 5 min. | NO |
| Pieces | 8 to 10 | Separate | 10 min. | |
| Cornish Hens | 8 to 12 | Turn over/Rearrange | 20 min. in refrig | YES |
| Turkey Breast [5 - 6 lbs. (2.5 - 3 kg)] | 8 to 12 | Turn over 2 to 3 times | | |

Auto Cook

Using the Auto-Cook Programs

These are tested and pre-timed (based on the power rating of this oven) for the quantity of food listed in the chart below. Locale, power fluctuations and personal tastes are not taken into account. Should you prefer your food cooked differently, use power and time method shown on page 10.

Example: To cook 1/2 lb. (8 oz) of fresh vegetables.

| | | |
|----|--|--|
| 1. |  | Press |
| 2. |  select 8 oz. | Press the SERVING/WEIGHT pad until the desired quantity appears on the screen. |
| 3. |  | Press the START pad. The time for cooking will appear on the screen and count, . . . Simply open the door to stir or to rearrange the food as per the directions. |

The following are the recommended servings / weights.

AUTO COOK CODES

| PAD | CATEGORY | SERVING/WEIGHT | HINTS |
|--------------|-------------------|--|--|
| BEVERAGE | COFFEE/TEA | 1 - 2 cups (6 - 7 oz each) | DO NOT heat liquids in your microwave oven without stirring first. Heated liquids can erupt if not mixed with air. |
| | SOUP | 1 & 2 servings (8 oz serving) | Use a water based soup. |
| BACON | | 2,3,4,6 slices | Place on microwave safe dish and cover with paper towels. |
| POTATO | | 1-4 (6-8 oz each) | Pierce skin with a fork, arrange in a circle. |
| VEGETABLES | FRESH VEGETABLES | 4, 8, 12, 16 oz (110,225,340,450 g) | Cover with a lid or plastic wrap. Add small amount of water. Stir occasionally during cooking. Let stand, covered 3-5 minutes before serving. |
| | FROZEN VEGETABLES | 5, 10, 16 oz (150, 300, 450 g) | Follow package directions or place in microwave dish, add water and cover with plastic wrap. |
| FROZEN FOODS | FROZEN PIZZA | 4 & 8 oz (110, 225 g) | Follow package directions. Place pizza on crisper shield. |
| | FROZEN ENTREE | 8,10,20,32 oz (225,300,600,900 g) | Follow manufacturers' directions for covering or removing covers. For best results, do not use frozen foods packaged in foil tray. Halfway through cooking, rearrange or stir. |
| | FROZEN DINNER | 11, 16 oz (300,430 g) | |
| POULTRY | CHICKEN PIECES | 6,12,18,24 oz (170,340,500,680 g) | Place skin-side up. Cover with plastic wrap. |
| | WHOLE CHICKEN | 3.5, 4.0, 5.0, 5.5 lb (1.5, 1.8, 2.2, 2.5 kg) | Place breast-side down. Cover with plastic wrap. Turn to breast-side up halfway through cooking. |

Popcorn Function



Set the desired weight of prepackaged microwave popcorn.



Press.
▶ Time appears on the screen and begins to count down.

| Press | Weight |
|---------|-----------------|
| once | 3.5 oz. (99 g) |
| twice | 3.0 oz. (90 g) |
| 3 times | 1.75 oz. (50 g) |

NOTES:

1. Use prepackaged **room temperature** microwave popcorn. Read manufacturers' instructions.
2. Place bag in oven according to manufacturers' directions.
3. Pop only one bag at a time.
4. After popping, open bag carefully, popcorn and steam are extremely hot.

5. Do not reheat unpopped kernels or reuse bag.
6. **Never** leave oven unattended when popping popcorn.

CAUTION:

If pre-packaged popcorn is of a different weight than the recommended weight, do not use the popcorn setting, or inadequate popping or a fire may occur. Follow the manufacturers' instructions.

Quick Min

This feature allows you to set cooking times easily instead of using Number Pads or to add extra cooking time.

To Set Cooking Time:

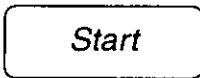

1. Press to set cooking time (up to 10 minutes).
 2. Press Start Pad. Cooking will start on **HIGH** power.
- To use other power levels, select the desired power level before setting the cooking time.
 - If you use Quick Min Pad to set your cooking time, you cannot use Number Pads to set more time or to change the cooking time. However, you can add more time with Quick Min Pad during cooking.

To Add Extra Cooking Time during cooking:



Press Quick Min Pad to add extra cooking time (up to 10 taps) during cooking.

- Cooking time changes to include extra time and continues to count down in the display.
- Extra time can be added during any of the three stages.

Auto Reheat

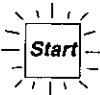

Select Serving of Food. (1-4)

Press.
▶ Time appears on the screen and begins to count down.

NOTES:

1. Auto Reheat can be programmed for 1 to 4 servings.
2. The recommended food items and approximate weights are listed in the chart at the right.

For best results follow these recommendations:

1. All foods must be previously cooked.
2. Foods should always be covered loosely with plastic wrap, wax paper or casserole lid.
3. All foods should have a covered stand time of 3 to 5 minutes.
4. **Do not** reheat bread and pastry products. Use manual power and time.
5. **Do not** reheat beverages.

| Foods | Number of Servings | Serving Size | Starting Temp. |
|---------------------|--------------------|--------------|-----------------|
| Plate of Food | 1 | 12 - 16 oz. | Refrig. |
| Meat, Poultry | 1 - 4 | 4 - 6 oz. | Refrig. |
| Casseroles | 1 - 2 | 8 oz. | Refrig. |
| Side Dishes | 1 - 4 | 4 - 6 oz. | Refrig. or Room |
| Soup, Sauces, Gravy | 1-2 | 6 - 8 oz. | Refrig. or Room |

Microwave Shortcuts

| FOOD | POWER | TIME (in minutes) | DIRECTIONS |
|---|--|-----------------------------|---|
| To Melt Butter , ¼ pound To Soften Butter , ¼ pound | MEDIUM MEDIUM-LOW | 1 - 2 ½ - 1 | Remove wrapper and place butter in a microwave-safe dish. |
| To Melt Chocolate , 1 square (1 oz.) To Melt Chocolate , ½ cup chips | MEDIUM MEDIUM | 2 - 3 2 - 3 | Remove wrapper and place chocolate in dish. Stir before adding more time. Chocolate holds its shape even when softened. |
| To Separate Bacon , 1 lb. | HIGH | ½ - 1 | Remove wrapper. After heating, use a plastic spatula to separate slices. |
| To Soften Cream Cheese , 3 oz. | MEDIUM-LOW | ½ - 1 | Remove wrapper and place in a bowl. |
| Cup of Water 1 cup (8 oz.) 2 cups (16 oz.) Cup of Milk 1 cup (8 oz.) 2 cups (16 oz.) | HIGH HIGH MEDIUM-HIGH MEDIUM-HIGH | 4 6½ 3½ - 4½ 7 - 8 | Heated liquids can erupt if not mixed with air. Do not heat liquids in your microwave oven without stirring first. |
| To Toast Coconut , ½ cup | HIGH | 1 - 3 | Place in a pie plate or bowl. Stir every 30 seconds. |
| To Brown Ground Beef , 1 lb. | HIGH | 3 - 5 | Crumble in microwave-safe colander set in another dish. Stir twice. |
| To Soften Ice Cream , ½ gallon | MEDIUM-LOW | 3 - 4 | ————— |
| To Roast Nuts , 1½ cups | HIGH | 3 - 5 | Spread nuts in 9-inch pie plate. Stir twice. |
| To Toast Sesame Seeds , ¼ cup | HIGH | 2½ - 4 | Place in a small bowl. Stir twice. |
| To Soften Brown sugar | HIGH | ½ - ¾ | Place 1 cup hard brown sugar in dish with a slice of bread or a wedge of apple. Cover with plastic wrap. |
| To Remove Oven Odors | HIGH | 5 | Combine 1 to 1½ cups of water with the juice and peel of one lemon in a small bowl. After heating, wipe interior of oven with damp cloth. |

Sensor Reheat / Sensor Cooking (NN-S787,S687,S587)

The **GENIUS** feature allows you to reheat/cook most of your favorite foods without having to select reheating/cooking times and power levels. THE OVEN DOES IT ALL FOR YOU.

Sensor Cook Pads

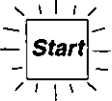
| | | | | | | | | |
|--|---|-----------------------|----------------|-----------------|--------------------|---------|-------------------|--|
| <p>1) Select SENSOR PAD ex. Potatoes (any quantity)</p> <div style="border: 1px solid black; padding: 2px; width: fit-content; margin: 5px 0;">Potato/ Vegetables</div> | <table border="1" style="font-size: small;"> <tr> <td>Potato/ Vegetables</td> <td>Rice/ Pasta</td> </tr> <tr> <td>Frozen Foods</td> <td>Casserole/ Stew</td> </tr> <tr> <td>Seafood</td> <td>Poultry/ Meats</td> </tr> </table> | Potato/ Vegetables | Rice/ Pasta | Frozen Foods | Casserole/ Stew | Seafood | Poultry/ Meats | <p>PRESS until proper food is displayed. MENU ACTION MESSAGE is "POTATO -- PRESS START".</p> |
| Potato/ Vegetables | Rice/ Pasta | | | | | | | |
| Frozen Foods | Casserole/ Stew | | | | | | | |
| Seafood | Poultry/ Meats | | | | | | | |
| <p>2) MORE/LESS* Optional</p> | | | | | | | | |
| <p>3)</p> <div style="text-align: center;">  </div> | <p>PRESS. MENU ACTION MESSAGE is "POTATO". Cooking will start. After steam is detected by the SENSOR, 2 beeps will sound, the remaining cooking time appears in the display window and begins to count down. 5 beeps will sound at the end of cooking. To recall the selected category during cooking, press any sensor cooking pad. The category will appear in the display.</p> | | | | | | | |



*MORE/LESS PAD

Preferences for food doneness vary with each individual. After having used Sensor Cooking a few times, you may decide you would prefer your food cooked to a different doneness. By using the **More/Less** pad, the programs can be adjusted to cook food for a longer or shorter time.

- 1 tap = MORE cooking
- 2 taps = LESS cooking

Press **MORE/LESS** before pressing **START**.

Sensor Reheat Pad

| | |
|--|--|
| <p>1)</p> <div style="text-align: center;">  </div> | <p>PRESS. MENU ACTION MESSAGE is "SENSOR REHEAT -- PRESS START". <i>Start</i> flashes.</p> |
| <p>2) MORE/LESS* Optional</p> | |
| <p>3)</p> <div style="text-align: center;">  </div> | <p>PRESS. MENU ACTION MESSAGE is "SENSOR REHEAT -- CLOSE DOOR". Sensor evaluation begins. After 2 beeps, display will count- down.</p> |

NOTES ON SENSOR REHEAT:

Casseroles - Add 3 to 4 tablespoons of liquid; cover with lid or plastic wrap. Stir when time appears in the display window.

Canned foods - Empty contents into casserole dish or serving bowl; cover dish with lid or plastic wrap. After reheating, release plastic wrap and stand.

Plate of food - Arrange food on plate; top with butter, gravy, etc. After reheating, release plastic wrap and stand.

Follow the recommendations on page 16, in addition to the following:

DO NOT:

1. Reheat bread and pastry products. Use manual power and time for these foods.
2. Reheat raw or uncooked food.
3. Use if oven cavity is warm.
4. Use for beverages.
5. Use for frozen foods.

Sensor Cooking

| | CATEGORY | WEIGHT RANGE | INSTRUCTIONS |
|-----------------------|-----------------------|---|---|
| Potato/ Vegetables | 1 x Potato | 1 - 4 potatoes 6 - 8 oz. (170 - 230 g) each | Pierce several times and place on a microwave safe dish. Do not cover. After beep, turn over. |
| | 2 x Fresh Vegetables | ½ - 2 lb (230-900 g) weight before peeling, trimming, etc. | Add water. Cover loosely with a lid or plastic wrap. After beep, stir or rearrange. |
| | 3 x Frozen Vegetables | 10 - 28 oz. (280 - 800 g) | Add 2 tbsp of water. Do not cook with butter or sauce. Cover with plastic wrap. After beep, stir or rearrange. |
| Rice/Pasta | 1 x Rice | Rice . . . Cold water ½ cup . . . 1 cup 1 cup . . . 2 cups 1½ cup . . . 3 cups 2 cups . . . 3½ cups | Place rice and cold water with ¼ to 1 teaspoon salt. Cover with lid or plastic wrap. After beep, stir several times. After cooking, stir and let stand 5 to 10 mins. |
| | 2 x Pasta | 4 - 8 oz. (120 - 230 g) | Place 1½-quarts of hot water, pasta, 1 tbsp. oil and 1 tsp. salt in a 4-qt. casserole. Cover with lid. After beep, stir occasionally. After cooking, rinse pasta with cold water. |
| Frozen Foods | 1 x Frozen Entrees | 7 - 32 oz. (200 - 900 g) | Follow manufacturers' directions for covering or removing covers. For best results, do not use frozen foods packaged in foil tray. |
| | 2 x Frozen Dinners | 9 - 18 oz. (260 - 510 g) | After beep, stir if possible or ladle gravy or sauce over. |
| Casserole/ Stew | 1 x Casserole | 1 - 4 qt. | Use appropriate amount of liquid. Cover with casserole lid. Stir occasionally or rearrange after beep. Use recipes in the Cooking Guide section. |
| | 2 x Stew | 1 - 4 qt. | |
| Seafood | 1 x Fish Fillets | ½ - 1½ lb. (230 - 680 g) | Arrange in a single layer in dish. Cover with lid or plastic wrap. Stir or rearrange after beep. |
| | 2 x Shellfish | ½ - 1½ lb. (230 - 680 g) | |
| Poultry/Meat | 1 x Bacon | 2 - 6 slices | Place on microwave safe dish. Cover with paper towels. |
| | 2 x Chicken Pieces | ½ - 2 lb. (230 g - 1 kg) | Place skin-side up. Cover with plastic wrap. Rearrange after beep. |
| | 3 x Whole Chicken | up to 6 lb. (3 kg) | Place breast-side down. Cover completely with plastic wrap. After beep, turn breast-side up, recover. |
| | 4 x Pork (roast) | 2 - 4 lb. (1 - 2 kg) | Place fat-side down. Cover with plastic wrap. After beep, turn over, recover, shield ends of roast with foil if necessary. Pork must reach 170°F (77°C) before serving. |
| | 5 x Beef-medium | 2 - 4 lb. (1 - 2 kg) | Place fat-side up. Cover with plastic wrap. |

For best results by Sensor, follow these recommendations.

BEFORE Reheating/Cooking:

1. The room temperature surrounding the oven should be below 95°F (35°C).
2. Food weight should be between 4 oz (120 g) and 24 oz (680 g).
3. Glass Tray and outside of container should be dry.
4. Cover foods loosely, but completely, with plastic wrap or place foods in a casserole dish with a proper fitting lid.
5. All foods should be taken from their normal storage place.

DURING Reheating/Cooking:

While "AUTO" is displayed in the display window, DO NOT open door. This causes inaccurate cooking results. Once the timer begins to count down, the oven door may be opened to stir, turn, shield or add foods.

AFTER Reheating/Cooking:

All foods should have a covered stand time.

Food Characteristics

Bone and Fat

Both bone and fat affect cooking. Bones may cause irregular cooking. Meat next to the tips of bones may overcook while meat positioned under a large bone, such as a ham bone, may be undercooked. Large amounts of fat absorb microwave energy and the meat next to these areas may overcook.

Density

Porous, airy foods such as breads, cakes or rolls take less time to cook than heavy, dense foods such as potatoes and roasts. When reheating donuts or other foods with different centers be very careful. Certain foods have centers made with sugar, water or fat and these centers attract microwaves (For ex., jelly donuts). When a jelly donut is heated, the jelly can become extremely hot while the exterior remains warm to the touch. This could result in a burn if the food is not allowed to cool properly in the center.

Quantity

Two potatoes take longer to cook than one potato. As the quantity of the food increases so does the cooking time. When cooking small amounts of food such as one or two potatoes, do not leave oven unattended. The moisture content in the food may decrease and a fire could result.

Shape

Uniform sizes heat more evenly. The thin end of a drumstick will cook more quickly than the meaty end. To compensate for irregular shapes, place thin parts toward the center of the dish and thick pieces toward the edge.

Size

Thin pieces cook more quickly than thick pieces.

Starting Temperature

Foods that are room temperature take less time to cook than if they are chilled or refrigerated or frozen.

Cooking Techniques

Piercing

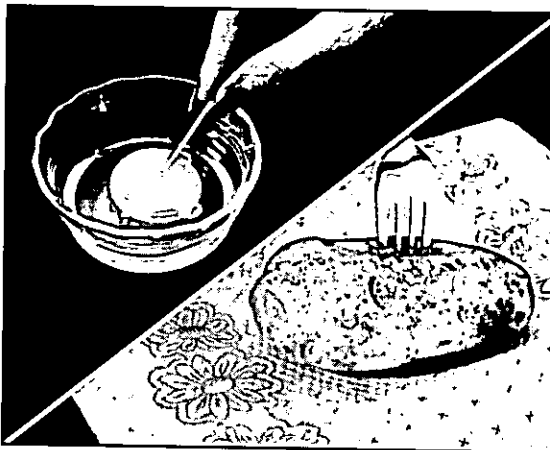

Foods with skins or membranes must be pierced, scored or have a strip of skin peeled before cooking to allow steam to escape. Pierce whole egg yolks and whites, clams, oysters, chicken livers, whole potatoes and whole vegetables. Whole apples or new potatoes should have a 1-inch strip of skin peeled before cooking. Score sausage and frankfurters.

Browning



Foods will not have the same brown appearance as conventionally cooked foods or these foods which are cooked utilizing the browning feature. Meats and poultry may be coated with browning sauce, Worcestershire sauce, barbecue sauce or shake-on browning sauce. To use, combine browning sauce with melted butter or margarine; brush on before cooking. For quick breads or muffins brown sugar can be used in the recipe in place of granulated sugar, or the surface can be sprinkled with dark spices before baking.

Cooking Techniques

Spacing

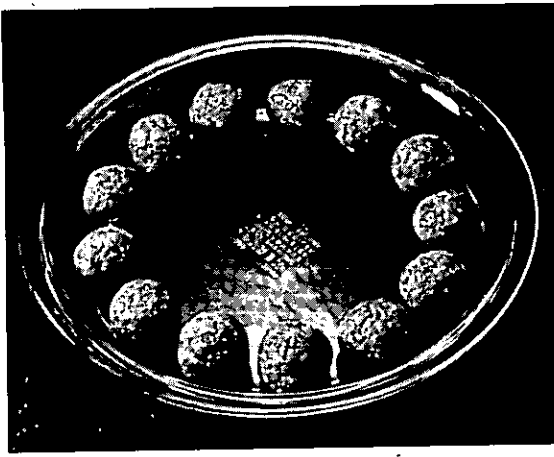

Individual foods, such as baked potatoes, cupcakes and appetizers, will cook more evenly if placed in the oven equal distances apart. When possible, arrange foods in a circular pattern.

Covering

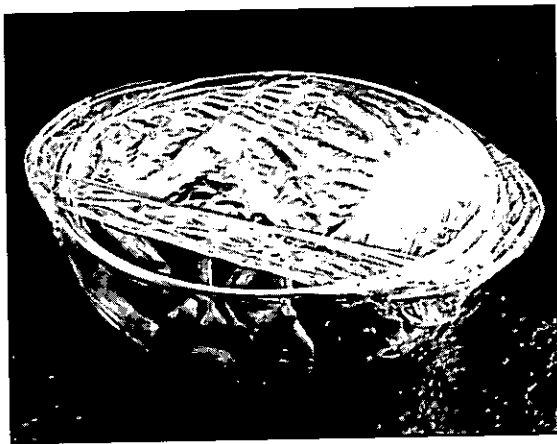

As with conventional cooking, moisture evaporates during microwave cooking. Casserole lids or plastic wrap are used for a tighter seal. When using plastic wrap, vent the plastic wrap by folding back part of the plastic wrap from the edge of the dish to allow steam to escape. Loosen or remove plastic wrap as recipe directs for stand time. When removing plastic wrap covers, as well as any glass lids, be careful to remove them away from you to avoid steam burns. Various degrees of moisture retention are also obtained by using wax paper or paper towels. However, unless specified, a recipe is cooked uncovered.

Shielding

Thin areas of meat and poultry cook more quickly than meaty portions. To prevent overcooking, these thin areas can be shielded with strips of aluminum foil. Wooden toothpicks may be used to hold the foil in place.

Timing

A range in cooking time is given in each recipe. The time range compensates for the uncontrollable differences in food shapes, starting temperature and regional preferences. Always cook food for the minimum cooking time given in the recipe and check for doneness. If the food is undercooked, continue cooking. It is easier to add time to an undercooked product. Once the food is overcooked, nothing can be done.

Stirring

Stirring is usually necessary during microwave cooking. We have noted when stirring is helpful, using the words once, twice, frequently or occasionally to describe the amount of stirring necessary. Always bring the cooked outside edges toward the center and the less cooked center portions toward the outside of the dish.

Rearranging

Rearrange small items such as chicken pieces, shrimp, hamburger patties or pork chops. Rearrange pieces from the edge to the center and pieces from the center to the edge of the dish.

Turning

It is not possible to stir some foods to redistribute the heat. At times microwave energy will concentrate in one area of a food. To help insure even cooking, these foods need to be turned. Turn over large foods, such as roasts or turkeys, halfway through cooking.

Stand Time

Most foods will continue to cook by conduction after the microwave oven is turned off. In meat cookery, the internal temperature will rise 5°F to 15°F (3°C to 8°C) if allowed to stand, tented with foil, for 10 to 15 minutes. Casseroles and vegetables need a shorter amount of standing time, but this standing time is necessary to allow foods to complete cooking in the center without overcooking on the edges.

Testing for Doneness

The same tests for doneness used in conventional cooking may be used for microwave cooking. Meat is done when fork-tender or splits at fibers. Chicken is done when juices are clear yellow and drumstick moves freely. Fish is done when it flakes and is opaque.

Meats

Directions for Roasting Meats

Tender cuts, such as beef and lamb roasts should be covered with wax paper to prevent spatter. For pork roasts or hams, cover with plastic wrap or place in an oven cooking bag.

Less tender cuts, such as pot roasts, should be cooked in liquid. Use 1 cup of liquid such as soup or broth per pound of meat. Use an oven cooking bag or covered casserole. Select a covered casserole deep enough so that the meat does not touch the lid.



TO COOK BY TIME:

Multiply the weight of the roast by the minimum recommended minutes per pound. Program Power and Time.

TO COOK BY SENSOR COOKING:

(NN-S787/NN-S687/NN-S587)

Place meat according to "Special Instructions" below. Cover with plastic wrap. Turn Pork Roast fat-side up halfway through cooking time.

| | |
|---|--|
| 1)  | PRESS once = bacon (see pg. 15) twice = chicken pieces 3 times = whole chicken 4 times = PORK 5 times = BEEF-MEDIUM |
| 2)  (optional) | SELECT DONENESS once = more twice = less |
| 3)  | PRESS |

Meat Roasting Chart for Sensor & Time Cooking

| MEAT | SENSOR COOKING CATEGORY | POWER & TIME COOKING [time in min/lb. (450 g)] | | TEMP. AFTER COOKING | SPECIAL INSTRUCTIONS |
|---|---|--|--|--|--|
| BEEF ROASTS [2½ to 4 Lb. (1.2 to 2 kg)] Rib/Boneless Rib/Top Sirloin Rare Medium Well Rump, Eye of round (High Quality) Rare Medium Well | — BEEF-MEDIUM — BEEF-MEDIUM — | MEDIUM MEDIUM MEDIUM | 9 to 11 12 to 14 4½ to 16½ | 130°F (55°C) 140°F (60°C) 160°F (70°C) | Place roast fat-side up. Cover roast with plastic wrap. |
| BEEF POT ROAST [2½ to 3½ Lb. (1.2 to 1.7 kg)] Chuck, Rump | — | MEDIUM LOW | 30 to 35 | — | Cover meat with liquid. Turn meat over half of cooking time. |
| PORK ROASTS [2½ to 4 Lb. (1.2 to 2 kg)] Bone-in Boneless | PORK PORK | MEDIUM MEDIUM | 15 to 18 15 to 18 | 170°F (77°C) 170°F (77°C) | Place roast fat-side down. Cover pork with plastic wrap. Turn over halfway through cooking time. |
| HAM (fully cooked)* Canned 3 Lb. (1.5 kg) Butt [8 Lb. (4 kg)] Shank [8 Lb. (4 kg)] Slice, 1-inch (2.5 cm) thick [1Lb (500 g)] | — | MEDIUM MEDIUM MEDIUM HIGH | 8 to 12 13 to 15 3 to 15 5 to 8 | 140°F (60°C) 140°F (60°C) 140°F (60°C) — | Place ham fat-side up. Cover ham with plastic wrap, except slice. |
| LAMB ROASTS [2½ to 4 lb. (1.2 to 2 kg)] Bone-in Medium Well Boneless Medium Well | — | MEDIUM MEDIUM MEDIUM MEDIUM | 8½ to 13 1 to 16 8 to 11 10 to 15 | 140°F (60°C) 160°F (70°C) 140°F (60°C) 160°F (70°C) | Place fat-side up. Cover with wax paper. |

* The recommended maximum weight will vary according to the cavity size of your microwave oven model and the shape of meat.

Meats

Directions for Convenience Meats

Pierce sausage links with fork and score frankfurters before cooking.

Arrange food in a single layer in dish. Cover with wax paper to prevent spatter. Bacon may be placed on a microwave-safe dish covered with paper towels. Cook according to times given in chart.

Let stand according to recommended time in chart.

Convenience Meats Chart

| MEAT | AMOUNT | MANUAL POWER SETTING | APPROX. COOKING TIME (in minutes) | STAND TIME (in minutes) |
|--|------------------------------------|----------------------|-----------------------------------|-------------------------|
| Bacon, Slices | 2 3 4 | HIGH | 1 to 2 2 to 2½ 2½ to 3 | 1 |
| Canadian Bacon, Slices [1 oz. (30 g)] | 2 4 6 | MEDIUM-HIGH | ½ to ¾ 1 to 2 3 to 4 | 1 |
| Frankfurters, scored | 2 4 | HIGH | 2 to 3 3 to 4 | 3 |
| Ham, Slices [about 2 oz. (60 g) ea.] | 2 4 | HIGH | 1½ to 2½ 2½ to 3½ | 2 |
| Hamburgers, well [4 oz. (120 g) ea.] | 1 2 4 | HIGH | 2 to 3 3 to 4 4½ to 5½ | 2 |
| Lamb Chops, shoulder, ¾-inch (2 cm) thick | 2 (about ½ lb.) 4 (about 1 lb.) | MEDIUM-HIGH | 5½ to 7 10½ to 12 | 3 |
| Pork Chops, rib or loin, ½-inch (1 cm) thick | 2 (about ½ lb.) 4 (about 1 lb.) | MEDIUM-HIGH | 4½ to 5½ 8 to 10 | 3 |
| Sausage Links, frozen [precooked, brown and serve] | 2 4 8 | HIGH | 1 to 2½ 1½ to 2½ 3 to 4 | 2 |
| Sausage Links, fresh [2 to 3 oz. (60 to 90 g) ea.] | 2 4 8 | HIGH | 4 to 6 6 to 8 8 to 10 | 3 |

Poultry

Directions for Roasting Poultry

Season as desired, but salt only after cooking. Browning sauce mixed with equal parts of butter will enhance appearance.

Poultry may be stuffed or unstuffed. Tie legs together with cotton string. Whole chicken should be placed breast-side down on a microwave roasting rack set in an 8-to 10-inch square dish or 2½-quart shallow oval casserole dish.

Cover with wax paper to prevent spatter.

During cooking it may be necessary to shield legs, wings and breast bone to prevent overcooking. Wooden toothpicks can be used to hold foil in place.

If a large amount of juice accumulates in the bottom of the baking dish, occasionally drain it. If desired, reserve for making gravy.

To Cook Whole Poultry:

Multiply the weight of the poultry by the minimum recommended minutes per pound. Program Power and Time.

To Cook Chicken Parts:



Arrange pieces skin-side up, with meatier portions toward edge of dish. Cover with wax paper. Poultry is cooked when juices are clear. If there is a slight pink color in the juice, return poultry parts to the oven and cook one or two minutes longer.

Let stand, covered, 5 minutes before serving.

TO COOK BY SENSOR COOKING:

(NN-S787/NN-S687/NN-S587)

Arrange pieces skin-side up, whole poultry breast-side up, with meatier portions towards edge of dish. Cover completely with plastic wrap. Cook on Sensor Cooking Category.

| | |
|---|---|
| 1)  | PRESS once = bacon twice = CHICKEN PIECES 3 times = WHOLE CHICKEN 4 times = pork 5 times = beef-medium |
| 2)  (optional) | SELECT DONENESS once = more twice = less |
| 3)  | PRESS |

After Cooking, check the temperature of large chickens and turkeys with a meat thermometer. Check the temperature in both thigh muscles. If the thermometer touches bone, the reading may be inaccurate.

DO NOT use a conventional thermometer in the oven when cooking by microwave. Use only a microwave-safe thermometer.

Poultry Chart for Sensor & Time Cooking

| POULTRY | SENSOR COOKING CATEGORY | POWER & TIME COOKING [time in min/lb. (450 g)] | | TEMP. AFTER COOKING | SPECIAL INSTRUCTIONS |
|--|-------------------------|--|-----------|-------------------------|--|
| | | | | | |
| Cornish Hens, whole [1 to 1½ lb. (500 to 750 g) ea.] | CHICKEN PIECES | HIGH | 7 to 9 | — | Place breast-side up. |
| Chicken parts | | | 7 to 8 | — | Place skin-side up. Cover with plastic wrap |
| Chickens [up to 4 lb. (2kg)] | WHOLE CHICKEN | MEDIUM-HIGH | 8½ to 11½ | — | Place breast-side down. Turn breast-side up after half of cooking time. Cover with plastic wrap. |
| Chickens [4 to 6 lb. (2 to 3 kg)] | | | 14 to 16 | 180°F–190°F (80°C–90°C) | |
| Turkey Breast [5 to 7 lb. (2.5 to 3.5 kg)] | — | MEDIUM | 15 to 17 | 180°F–190°F (80°C–90°C) | Place breast-side up. |
| Duck [3 to 5 lb. (1.5 to 2.5 kg)] | — | MEDIUM-HIGH | 8 to 10 | 180°F–190°F (80°C–90°C) | — |
| Turkey* [8 to 12 lb. (4 to 6 kg)] | — | | 12 to 14 | 180°F (80°C) | — |

* The recommended maximum weight of turkey will vary according to the cavity size of your microwave oven model.



Fish and Seafood

Directions for Preparing Fish and Seafood

Use fresh or defrosted clean fish. Arrange fish in a single layer in dish. For best results, avoid overlapping edges as this will prevent fish from cooking evenly.

Place thicker sections toward edge of the dish. (i.e., tail sections toward center).

Cover dish loosely, but completely with plastic wrap.

| | |
|---|---|
| 1)  | PRESS once = FISH FILLETS twice = SHELLFISH |
| 2)  (optional) | SELECT DONENESS once = more twice = less |
| 3)  | PRESS |

TO COOK BY SENSOR COOKING:

(NN-S787/NN-S687/NN-S587)

Stir shrimp or scallops when time appears on the screen. Let stand, covered, 5 minutes.

TO COOK BY TIME: Arrange shrimp and scallops in single layer in dish. Cook on the recommended power level and minimum time in the chart. Rearrange or stir shrimp or scallops halfway through cooking.

Test for doneness before adding extra cooking time. The color of seafood and fish should be opaque and the fish should flake easily when tested with a fork. If undercooked, return to oven and cook 15 to 30 seconds longer at recommended power level.

After cooking, let stand, covered, 3 to 5 minutes before serving. Stand time allows the internal temperature to equalize throughout the food and thereby completes the cooking process.

Fish and Seafood Chart for Sensor & Time Cooking

| FISH OR SEAFOOD | SENSOR COOKING | | TIME COOKING | | |
|---|---------------------------------|--------------|------------------------------|----------------------|-----------------------------------|
| | AMOUNT | CATEGORY | AMOUNT | MANUAL POWER SETTING | APPROX. COOKING TIME (in minutes) |
| Fish Fillets | 1/2 to 2 lb. (250 g to 1 kg) | FISH FILLETS | 1 lb. (500 g) | HIGH | 5 to 7½ |
| Fish Steaks [1-inch (2.5 cm) thick] | — | — | 1 lb. (500 g) | MEDIUM-HIGH | 5½ to 7 |
| Scallops (sea) | 1/2 to 2 lb. (250 g to 1 kg) | SHELLFISH | 1 lb. (500 g) | MEDIUM-HIGH | 5 to 6 |
| Shrimp, medium size (shelled and cleaned) | 1/2 to 2 lb. (250 g to 1 kg) | SHELLFISH | 1 lb. (500 g) | MEDIUM-HIGH | 5 to 6 |
| Whole fish, cleaned (stuffed or unstuffed) | — | — | 1 to 1½ lb. (500 g–750 g) | HIGH | 5 to 7 |

Casseroles

Directions for Preparing Casseroles



Prepare casseroles and stews according to recipe directions. Stew meats are not browned before cooking. Omit any oil or fat and flour used for browning. Fresh and firm vegetables such as potatoes, carrots, rutabagas and beans are added at the beginning of cooking. Frozen vegetables and fresh vegetables with soft texture such as zucchini, tomatoes or mushrooms are added during the last 30 minutes of cooking. Defrosted frozen vegetables are canned vegetables are added with the thickener. Place covered microwave-safe dish in oven.

TO COOK BY SENSOR COOKING:

(NN-S787/NN-S687/NN-S587)

Select Sensor Category "Casserole" and press **Start** Pad.

TO COOK BY TIME: Prepare casseroles or stew by microwaving at lower power levels. **MEDIUM** and **MEDIUM-LOW** power levels allows flavors to blend and less tender cuts of meat to become tender. Use our recipes in the Panasonic Cooking Guide as a guideline for adapting your favorite recipes (see page 31).

| | |
|--|--|
| 1)  | PRESS 1 x = CASSEROLE 2 x = STEW |
| 2)  | SELECT DONENESS 1 x = more 2 x = less |
| 3)  | PRESS |

Vegetables

To Cook Fresh Vegetables

Weight given in the chart are purchase weights before peeling, trimming, etc. Prepare vegetables for cooking; cut slice or trim as directed in chart. Cook vegetables in covered casserole, except for whole, unpeeled vegetables.

Whole, unpeeled vegetables, such as potatoes or eggplant, should be pierced before cooking and arranged on microwave-safe dish in the oven. Arrange potatoes in a circular pattern on dish.

TO COOK BY TIME: Cook according to the time recommended in the chart. Two-thirds of the way through cooking, stir, rearrange, and/or turn vegetables over.

TO COOK BY SENSOR COOKING: (NN-S787/NN-S687/NN-S587)

When time appears on the screen, stir vegetables.

After cooking, stir vegetables. Let stand, covered, before serving. Vegetables that are cut into pieces should stand 3 minutes. Whole vegetables should stand 5 minutes.



To Cook Frozen Vegetables

TO COOK BY SENSOR COOKING: (NN-S787/NN-S687/NN-S587)

Empty 10-28 oz. package of frozen vegetables into glass container. Add 2 tablespoons water. Cover dish with lid, or loosely but completely, with plastic wrap. Cook on **Frozen Vegetables**.

For frozen vegetables in the pouch, pierce a hole in the pouch, place on a dish and cook on **Frozen Vegetables**. After cooking, stir and let stand, covered, 3 minutes before serving. **DO NOT** cook frozen vegetables which contain any type of butter or sauce by Sensor Cooking Pad.

Never leave oven unattended when heating small amounts of foods such as one or two potatoes. Potatoes may catch fire if overcooked and cause severe damage to the oven and surroundings.

| | |
|---|---|
| 1)  | PRESS once = POTATO twice = FRESH VEGETABLES 3 times = FROZEN VEGETABLES |
| 2)  (optional) | SELECT DONENESS once = more twice = less |
| 3)  | PRESS |

Fresh Vegetable Chart for Sensor & Time Cooking

| VEGETABLE | AMOUNT | WATER | SENSOR COOKING CATEGORY | APPROX. COOKING TIME at HIGH Power (In minutes) |
|---|-------------------------------|---------------|-------------------------|---|
| Artichokes, 6 to 8 oz. ea. | 1 | 2 tablespoons | FRESH VEG. | 6 to 7 |
| | 2 | 1/4 cup | | 9 to 11 |
| | 4 | 1/4 cup | | 14 to 16 |
| | | | | |
| Asparagus, 6-in spears | 1 lb. (500 g) | 2 tablespoons | FRESH VEG. | 7 to 8 |
| Beans, green/wax, cut into 1½-in. pieces | 1 lb. (500 g) | 1/4 cup | | 7 to 9 |
| Broccoli, cut into spears | 1 lb. (500 g) | 1/4 cup | | 7 to 10 |
| Brussels Sprouts | 1 tub [10 oz. (300 g)] | 2 tablespoons | | 7 to 9 |
| Cabbage, shredded | 1 lb. (500 g) | 1/4 cup | FRESH VEG. | 7 to 9 |
| Carrots, sliced 1/2-in. thick | 1 lb. (500 g) | 1/4 cup | | 7 to 9 |
| Corn, fresh on the Cob | 1 ear | 2 tablespoons | FRESH VEG. | 6 to 7 |
| | 2 ears | 2 tablespoons | | 7 to 9 |
| | 4 ears | 1/4 cup | | 12 to 14 |
| Eggplant, fresh cubed Whole (pierce skin several times) | 1 lb. (500 g) | 1/4 cup | FRESH VEG. | 7 to 8½ |
| | 1 to 1½ lb. (500 to 600 g) | — | | 4½ to 7 |
| Onions, small whole | 8 to 10 [1 lb. (500 g)] | 1/4 cup | FRESH VEG. | 6½ to 7½ |
| Peas, green, shelled | 2 lb. (1kg) | 1/4 cup | FRESH VEG. | 6 to 8 |
| Potatoes, 8 to 9 oz. ea. Cook uncovered, turn over halfway through cooking time. Pierce skin several times before cooking. | 1 | — | POTATO | 5 to 7 |
| | 2 | — | | 8 to 10 |
| | 4 | — | | 13 to 15½ |
| Spinach, leaf | 1 lb. (500 g) | 2 tablespoons | FRESH VEG. | 5½ to 7 |
| Squash, Summer, sliced 1/2-in. thick | 1 lb. (500 g) | 2 tablespoons | FRESH VEG. | 6 to 8 |
| Squash, Winter, Cut in half, scoop out seeds, place cut-side down. | 1 lb. (500 g) | 1/4 cup | FRESH VEG. | 6½ to 7½ |

Pasta, Rice and Cereal

| ITEM | CONTAINER | AMOUNT OF HOT WATER | SENSOR COOKING CATEGORY | POWER | APPROX. COOKING TIME (in min.) | STAND TIME (in min.) | SPECIAL INSTRUCTIONS |
|---|--|---|-------------------------|---|--|----------------------|--|
| PASTA Egg Noodles medium width (8 oz.) Specialty Noodle (8 oz.) Spaghetti or Fusilli (8 oz. broken) Frozen Tortellini (16 oz.) | 3-qt. casserole 3-qt. casserole 3-qt. casserole 3-qt. casserole | 1½ quarts 1½ quarts 2 quarts 1½ quarts | PASTA | HIGH HIGH HIGH HIGH | 7 - 9 8 - 12 12 - 14 7 - 9 | 3 3 3 3 | Add 1 teaspoon oil and 1 teaspoon salt to hot water. For Sensor Cooking, add pasta, cook uncovered. For Time Cooking, cover and bring water to boil (HIGH for 10 - 15 minutes). Stir in pasta. Cook, covered; stir occasionally. Let stand, covered. Pasta that is to be added to a casserole should be slightly undercooked. |
| RICE Flavored Rice Mix (4.4 to 7.5 oz.) Long Grain (1 cup) Short Grain (1 cup) | 2-qt. casserole 2-qt. casserole 2-qt. casserole | as pkg. directs 2 cups 2 cups | RICE | MEDIUM MEDIUM -LOW MEDIUM -LOW | 15 - 30 or as pkg. directs 13 - 16 10 - 12 | 10 10 10 | Cover & heat water to a boil at HIGH (approx. 4 - 7 min.). Add rice, salt & butter (amount of salt & butter as package directs). Cook covered; stir. For long grain rice, combine all ingredients, cook covered. Stir after 2 beeps. Let stand, covered. For Sensor Cooking, combine all ingredients in cold water. Cook covered. Stir & let stand. |
| CEREAL Cream of Wheat (Reg.) 1 serving (2½ tbsp.) 2 servings (½ cup) | 1-qt. glass bowl 1½-qt. glass bowl | ¾ cup 1½ cups | | HIGH HIGH | 2 - 4 3 - 5 | 1 1 | Stir cereal into water. Stir frequently. Cook uncovered. Stir once before stand time. |
| Farina 1 serving (3 tbsp.) 2 servings (6 tbsp.) | 1-qt. glass bowl 1½-qt. glass bowl | 1 cup 2 cups | | HIGH HIGH | 2 - 3 2 - 4 | 1 1 | Cover and heat hot water to a boil at HIGH (approx. 3 to 6 min.) Slowly add cereal; stirring frequently. Cook uncovered. Stir once before stand time. |
| Oatmeal (Quick) 1 serving (½ cup) 2 servings (¾ cup) 4 servings (1½ cups) | individual serving dish 2 individual serving dishes 2-qt. glass bowl | ½ cup 1½ cups 3 cups | | HIGH HIGH HIGH | 1 - 2 3 - 4 5 - 6 | 1 1 2 | Combine water and cereal. Cook uncovered. Stir once before stand time. |
| Wheat Bran Cereal 1 serving (½ cup) 2 servings (¾ cup) 4 servings (1 cup) | 1-qt. glass bowl 1½-qt. glass bowl 2-qt. glass bowl | ¾ cup 1½ cups 3 cups | | HIGH HIGH HIGH | 3 - 4 6 - 7½ 7 - 8 | 1 1 2 | |

To prepare Instant Rice: Combine 1 cup water, 1 teaspoon butter and dash salt in 1-quart casserole. Cover with lid. Cook at **HIGH** 2 to 3 minutes or until water boils. Stir in 1 cup rice: Let stand, covered, 5 minutes. Fluff lightly with fork before serving.

Quick Breads and Cakes

Layer cakes must be baked **one layer at a time**, or the entire cake mix may be baked in a 16-cup fluted tube dish. Prepare batter according to package, chart or recipe directions.

Use dishes recommended in chart or in recipes. Glass dishes allow the bottom of the cakes to be checked for doneness. When the product is removed from the oven, visually check bottom.

If cake is to be inverted or removed from dish, such as layer cakes or upside-down cake, grease sides of dish and line bottom of 8" or 9" round or square dish with wax paper.

If cake is to be served directly from the dish, grease bottom of dish. Never flour cake dishes, fluted tube dishes or muffin pans.

Cook second layer of 8" or 9" round or square cake immediately after the first. The remaining batter can be used for cupcakes.

Check during cooking. Different brands vary in ingredients and density of batter; cooking times may be slightly different than those given in chart.

After cooking:

Test for doneness. Check to make sure edges of cake are dry and have begun to pull away from sides of dish, and toothpick inserted near center comes out clean.

Let stand, uncovered, on a flat surface for 10 to 15 minutes. Stand time is important to allow cakes and cupcakes to finish baking. Cakes and breads that are to be inverted should be loosened from the sides of the dish. Carefully turn out of dish. Remove wax paper from bottom of cake. Store, covered, until ready to serve.

For best results, it is recommended to follow microwave cooking instructions issued by the individual cake mix manufacturers. For best results, always undercook.

| ITEM | AMOUNT OF BATTER | PREPARATION/ DISH SIZE | FIRST STAGE | SECOND STAGE | SPECIAL INSTRUCTIONS | STAND TIME |
|--------------------------------------|---|--|--|-----------------------------|---|----------------------|
| Quick Bread (14 to 17 oz.) | All batter | Line bottom of 8½" x 4½" x 2½" loaf dish with wax paper. | MEDIUM-LOW 7 - 9 min. | HIGH 4½ - 5½ min. | Shield each end with a 3" strip of foil. Mold foil around handle. | 15 min. uncovered |
| Cornbread (7 or 8 oz.) | All batter | Grease 8" or 9" round or square dish. | MEDIUM-HIGH 3½ - 6 min. | — | Cover with wax paper. | 10 min. uncovered |
| Gingerbread (14 oz.) | All batter | 8" square dish | HIGH 8 - 12 min. | — | Shield each corner with a piece of foil. Place dish on a microwave-safe inverted pie plate. | 15 min. uncovered |
| Muffins (Cook 6 at a time) | Fill ½ full | 6-cup muffin pan lined with paper baking cups | MEDIUM 2½ - 5 min. | — | — | 5 min. uncovered |
| Cake Mix (18 to 20¼ oz.) | 2¼ cups | Wax paper-lined 8" or 9" round or square glass baking dish | MEDIUM-LOW 6 - 8 min. | HIGH 3 - 4½ min. | Place dish on microwave-safe inverted pie plate Cover with wax paper. | 10 min. uncovered |
| Cake Mix (18 to 20¼ oz.) | Prepare batter according to package directions. Pour all batter into pan. | Generously grease 16-cup fluted tube pan | MEDIUM-LOW 8 - 10 min. | HIGH 6 - 11 min. | Cover pan with wax paper. | — |
| Cupcakes | 2 rounded tablespoons batter per cupcake. Fill paper baking cups ½ full. | Line microwave muffin pan with paper baking cups. 2 4 6 | MEDIUM (in minutes) 1½ - 2 2 - 2½ 3½ - 4½ | — | Cover with wax paper. | 5 min. uncovered |

Eggs and Cheese

SCRAMBLED EGGS

Beat eggs, 1 tablespoon milk and dash of salt for each egg. Pour into greased glass container. Cook at **MEDIUM-HIGH** according to time in the chart. Stir two-thirds of the way through the cooking time. Stir and let stand. Eggs will continue to cook during stand time and should be slightly undercooked after cooking.

| Eggs | Container | Cooking Time (in min.) | Stand Time (in min.) |
|------|---------------------|------------------------|----------------------|
| 1 | 1-cup glass measure | ¾ - 1¼ | 1 |
| 2 | 1-cup glass measure | 1½ - 2 | 1½ |
| 4 | 1-quart bowl | 3¾ - 3¾ | 1½ |
| 6 | 1½-quart bowl | 4¾ - 5½ | 2 |

POACHED EGGS

Place 1½ cups hot water and a dash of vinegar and salt in 2-quart casserole and heat at **HIGH** 5 to 7 minutes, or until water boils. Break egg(s) into boiling water and with toothpick pierce egg yolk twice and egg white several times. Cook at **MEDIUM-HIGH** according to the time given in the chart. Let stand. Eggs will continue to cook during stand time and should be slightly undercooked after cooking.

| Eggs | Cooking Time (in minutes) | Stand Time (in minutes) |
|------|---------------------------|-------------------------|
| 1 | ½ - ¾ | 1 |
| 2 | 1 - 1¼ | 2 |
| 4 | 1¾ - 2 | 2 |

Eggs cannot be hard-cooked in their shells in a microwave oven. Pressure will build up and the egg will explode.

Pies

Prepare pastry according to recipe or package directions.

If desired, for a single crust homemade pastry recipe, substitute ½ cup whole wheat flour for ½ cup all-purpose flour.

Microwave pie crusts are light in color. A few drops of yellow food coloring may be mixed with the liquid before adding liquid to the flour mixture. This will give the crust a pale yellow color.

Roll dough out and gently place in pie plate.

Trim edge so a ¼-inch overhang remains. Roll overhang down to rim of pie plate. Flute edge.

Prick bottom and sides of pastry with fork.

Let pie crust rest 10 minutes. This rest time helps reduce shrinkage.

If desired, brush with dark corn syrup or molasses for sweet fillings, or brush with Worcestershire or soy sauce for savory fillings.

For frozen crust, thaw and remove from foil pie plate and place in an 8- or 9-inch glass pie plate. Place on an inverted pie plate. Heat ½ minute, then prick crust and, if desired, brush with dark corn syrup, molasses, Worcestershire or soy sauce.

For crumb crusts, combine ½ cup butter and ¼ cup sugar in medium bowl. Heat at **HIGH** 1½ to 2 minutes, or until butter is melted. Stir in 1¼ cups crumbs (graham crackers, chocolate or vanilla wafers). Firmly pat into greased 9-inch pie plate.

Cook according to directions given in chart.

Visually check for doneness. Pastry crusts should be opaque. If crust is undercooked, add cooking time in 15 second increments.

Let stand until cool. Chill crumb crusts.

PIE CRUST CHART

| ITEM | POWER | APPROX. COOKING TIME (in minutes) |
|--------------------------------|--------------------|-----------------------------------|
| Homemade or Mix | HIGH | 3 to 4 |
| Refrigerated | MEDIUM-HIGH | 4½ to 5 |
| Frozen | HIGH | 2 to 2½ |
| Graham Cracker or Cookie Crumb | MEDIUM-HIGH | 2 to 2½ |

Before Requesting Service

All these things are normal:

The oven causes interference with my TV.

Some radio and TV interference might occur when you cook with the microwave oven. This interference is similar to the interference caused by small appliances such as mixers, vacuums, blow dryers, etc. It does not indicate a problem with your oven.

The oven lights dim.

When cooking with a power other than HIGH, the oven must cycle to obtain the lower power levels. The oven light will dim and clicking noises can be heard when the oven cycles.

Steam accumulates on the oven door and warm air comes from the oven vents.

During cooking, steam and warm air are given off from the food. Most of the steam and warm air are removed from the oven by the air which circulates in the oven cavity. However, some steam will condense on cooler surfaces such as the oven door. This is normal.

I accidentally ran my microwave oven without any food in it.

Running the oven empty for a short time will not damage the oven. However, we do not recommend operating the microwave oven without any food in it.

PROBLEM

POSSIBLE CAUSE

REMEDY

| | | | |
|---|---|---|---|
| Oven will not turn on. | → | The oven is not plugged in securely. | Remove plug from outlet, wait 10 seconds and reinsert. |
| | | Circuit breaker or fuse is tripped or blown. | Reset circuit breaker or replace fuse. |
| | | There is a problem with the outlet. | Plug another appliance into the outlet to check if it is working. |
| Oven will not start cooking. | → | The door is not closed completely. | Close the oven door securely. |
| | | Start Pad was not pressed after programming. | Press Start Pad. |
| | | Another program entered already in the oven. | Press Stop/Reset Pad to cancel the previous program and program again. |
| | | The program is not correct. | Program again according to the Operating Instructions. |
| | | Stop/Reset Pad has been pressed accidentally. | Program oven again. |
| The words "DEMO MODE" appear on the screen. | → | Clock pad has been pressed three times. | Deactivate mode by pressing Clock Pad three times. |
| When the oven is turning on, there is noise coming from the glass tray. | → | The roller ring and oven bottom are dirty. | Clean these parts according to Care of Your Oven (next page). |

If it seems there is a problem with the oven, contact an authorized Servicer.

Care of Your Microwave Oven

BEFORE CLEANING:

Unplug at socket of the oven. If impossible, leave oven door open to prevent oven from accidentally turning on.

AFTER CLEANING:

Be sure to replace the Roller Ring and Glass Tray in the proper position and press Stop/Reset Pad to clear the screen.

Inside of the oven:

Wipe with a damp cloth. Mild detergent may be used if the oven gets very dirty. The use of harsh detergent or abrasives is not recommended.

Glass Tray:

Remove and wash in warm sudsy water or in a dishwasher.

Outside oven surfaces:

Clean with a damp cloth. To prevent damage to the operating parts inside the oven water should not be allowed to seep into ventilation openings.

Control Panel:

If it becomes wet, clean with a soft, dry cloth. Do not use harsh detergents or abrasives on the Control Panel.

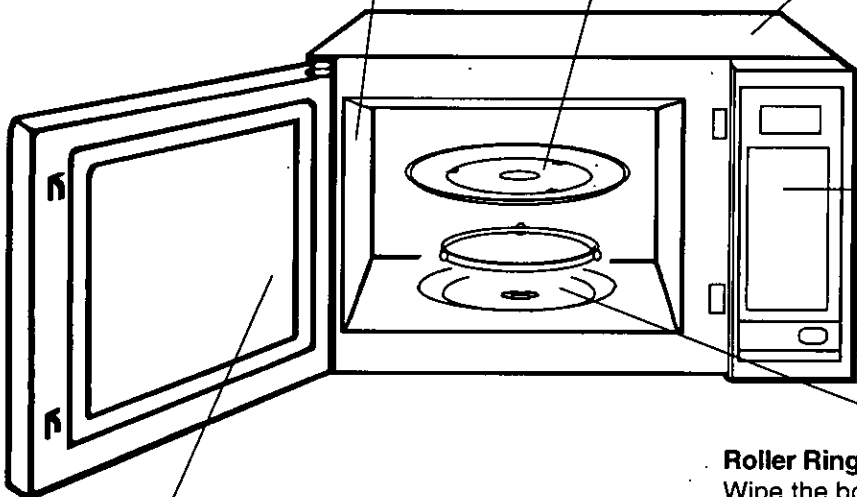

Oven Door:

Wipe with a soft cloth when steam accumulates inside or around the outside of the oven door. During cooking, especially under high humidity conditions, steam is given off from the food. (Some steam will condense on cooler surfaces, such as the oven door.) This is normal.

Roller Ring and oven cavity floor:

Wipe the bottom surface of the oven with mild detergent water or window cleaner and dry. Roller Ring may be washed in mild sudsy water or dishwasher. These areas should be kept clean to avoid excessive noise.

For more information regarding microwave cooking, order our new COOKING GUIDE.

| DESCRIPTION | PART NUMBER | PRICE |
|--|--|---------|
| Instruction/Operating Manual (this book) | B00039410AP | ① |
| Cooking Guide | B000B8250AP | ① |
| Glass Tray (see diagram on page 7) | A06015690QP (NN-S587, E577) | \$18.79 |
| | A06014000AP (NN-S77, E777, S687, E677) | \$24.31 |
| Roller Ring (see diagram on page 7) | B290D5950AP (NN-S587, E577) | \$ 8.40 |
| | B290D5500AP (NN-S77, E777, S687, E677) | \$13.16 |

① For pricing quotes, call or write the Parts & Literature Department at the phone or address listed below. Please have your credit card information readily available.
Shipping & handling are not included. Price & availability subject to change. Sorry, no COD's.

PANASONIC SERVICES COMPANY
20421 84th Avenue South
Kent, WA 98032

(800) 833-9626 - Phone
(800) 237-9080 - FAX

Quick Guide to Operation

| Feature | How to Operate |
|--|--|
| To Set Clock (☛ page 10) | <p>Press twice. Enter time of day. Press once.</p> |
| Power and Time Setting (☛ page 10) | <p>Select power. Set cooking time.</p> |
| To Defrost using Manual Defrost (☛ page 10) | <p>Select defrost. (2 x's) Set time.</p> |
| "Auto Defrost" (☛ page 11) | <p>Enter weight.</p> |
| To Reheat using "Sensor Reheat" (☛ page 13) | |
| To Cook using "Sensor Cooking" (☛ page 13 - 14) | <p>e.g. </p> <p>Select desired category.</p> |
| To Cook using "Auto cook" (☛ page 15) | <p>Select desired category. Select weight.</p> |
| To Cook using "Popcorn" (☛ page 16) | <p>Select weight.</p> |
| To use as a Timer (☛ page 17) | <p>Press once.</p> |
| To use to set Stand Time (☛ page 17) | <p>(Input Cooking Program.)</p> |
| To set Delay Start (☛ page 17) | <p>(Input Cooking Program.)</p> |
| To Cook using "Quick Min" (☛ page 16) | <p>Tap desired number of times (up to 10 minutes).</p> |
| To use "Function Pad" (☛ page 8-9) | <p>Select category. Select option.</p> |

Panasonic Consumer Electronics Company, Division of Matsushita Electric Corporation of America
One Panasonic Way,
Secaucus, New Jersey 07094

Panasonic Sales Company, Division of Matsushita Electric of Puerto Rico, Inc. ("PSC")
Ave. 65 de Infantería, Km. 9.5
San Gabriel Industrial Park,
Carolina, Puerto Rico 00985

B00039410AP

S0197-0
Printed in U.S.A.