

This Owner's Manual is provided and hosted by [Appliance Factory Parts](#).



# PANASONIC NN-L530 Owner's Manual

[Shop genuine replacement parts for PANASONIC  
NN-L530](#)



[Find Your PANASONIC Microwave Parts - Select From 742 Models](#)

----- Manual continues below -----

# Panasonic®

## Operating Instructions

Microwave Oven  
Model NN-S540  
NN-L530

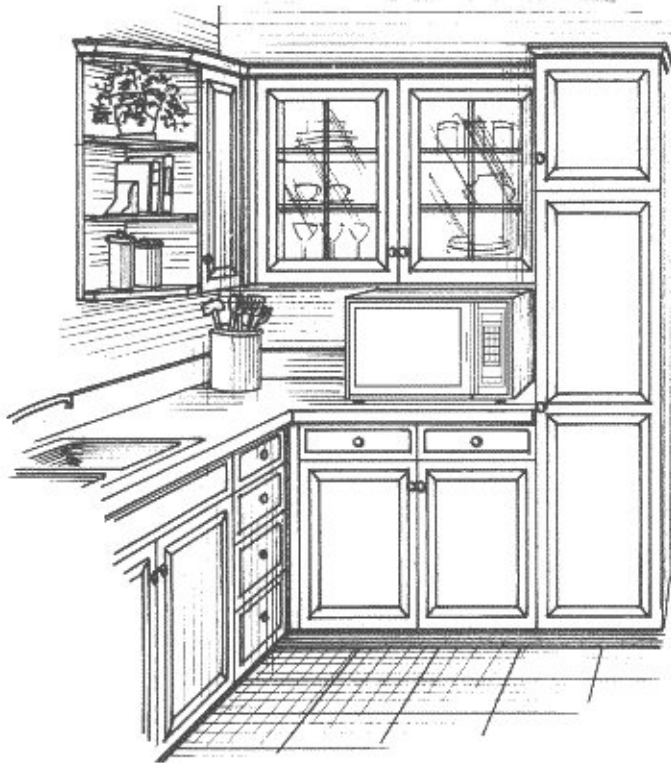

This manual contains Safety Instructions, Operating Instructions and Maintenance of the oven.  
Before operating this oven, please read these instructions completely.  
Antes de operar este producto, lea este instructivo en su totalidad.  
El manual de instrucciones en español puede ser encontrada en la páginas 19-25  
(Spanish Operating Instructions can be found on pages 19-25)

## PRECAUTIONS TO AVOID POSSIBLE EXPOSURE TO EXCESSIVE MICROWAVE ENERGY

- (a) Do not attempt to operate this oven with the door open since open-door operation can result in harmful exposure to microwave energy. It is important not to defeat or tamper with the safety interlocks.
- (b) Do not place any object between the oven front face and the door or allow soil or cleaner residue to accumulate on sealing surfaces.
- (c) Do not operate the oven if it is damaged. It is particularly important that the oven door close properly and that there is no damage to the:
  - (1) door (bent),
  - (2) hinges and latches (broken or loosened),
  - (3) door seals and sealing surfaces.
- (d) The oven should not be adjusted or repaired by anyone except properly qualified service personnel.

### Technical Specifications

	<b>NN-S540/NN-L530</b>
Power Consumption:	12.0 Amps, 1350 W
Output:*	1100 W
Outside Dimensions (H x W x D):	11 <sup>7</sup> / <sub>8</sub> " x 20 <sup>3</sup> / <sub>8</sub> " x 16" (301 x 518 x 407 mm)
Oven Cavity Dimensions (H x W x D):	8 <sup>7</sup> / <sub>8</sub> " x 14 <sup>3</sup> / <sub>4</sub> " x 15 <sup>3</sup> / <sub>16</sub> " (225 x 375 x 386 mm)
Operating Frequency:	2,450 MHz
Uncrated Weight:	Approx. 26.5 lbs. (12 kg)

\*IEC 705-88 Test procedure

Specifications subject to change without notice.

The serial number of this product may be found on the rear side of the oven. You should note the model number and the serial number of this oven in the space provided and retain this book as a permanent record of your purchase for future reference.

Model No. \_\_\_\_\_

Serial No. \_\_\_\_\_

Date of Purchase \_\_\_\_\_

# CONTENTS

## Before Operating

Precautions .....	Inside Front Cover
Important Safety Instructions .....	2
Installation Instructions .....	3
Grounding Instructions .....	3
Safety Precautions .....	4
Cookware and Utensil Guide .....	5
Feature Diagram .....	6
Control Panel .....	6

## Operation & Hints

To Set Clock .....	7
To use Popcorn Pad .....	8
To Reheat using Power & Time Setting .....	7
Auto Reheat Pad .....	10
To Defrost using Power & Time Setting .....	7
Inverter Turbo Defrost Pad .....	8-9
To Cook using Power & Time Setting .....	7
Inverter Auto Cooking .....	10-11
Quick Min .....	7
To Set Timer (Stand time / Delay start) .....	12
Microwave Shortcuts .....	13
Food Characteristics .....	14
Cooking Techniques .....	15
Quick Guide to Operation .....	Back Cover

## Maintenance

Technical Specifications .....	Inside Front Cover
To order Accessories, Books, etc. ....	16
Care of Your Microwave Oven .....	16
Before Requesting Service .....	17
Warranty .....	18

## Manual de instrucciones (Spanish Operating Instructions)

Precauciones .....	19
Instrucciones de Seguridad .....	20
Instrucciones para Conexión a Tierra .....	21
Instrucciones de Instalación .....	22
Sugerencias Útiles .....	23
Panel de Control .....	24
Sugerencias .....	24
Guía Rápida de Operación .....	25

# IMPORTANT SAFETY INSTRUCTIONS



Your microwave oven is a cooking device and you should use as much care as you use with a stove or any other cooking device. When using this electric appliance, basic safety precautions should be followed, including the following:

**WARNING**—To reduce the risk of burns, electric shock, fire, injury to persons, or exposure to excessive microwave energy:

1. Read all instructions before using the appliance.
2. Read and follow the specific "**PRECAUTIONS TO AVOID POSSIBLE EXPOSURE TO EXCESSIVE MICROWAVE ENERGY**," found inside of the front cover.
3. This appliance must be grounded. Connect only to properly grounded outlet. See "**GROUNDING INSTRUCTIONS**" found on page 3.
4. Install or locate this appliance only in accordance with the installation instructions found on page 3.
5. Do not cover or block any openings on this appliance.
6. Do not store or use this appliance outdoors.  
Do not use this product near water—for example, near a kitchen sink, in a wet basement, or near a swimming pool, and the like.
7. Use this appliance only for its intended use as described in this manual. Do not use corrosive chemicals, vapors, or non-food products in this appliance. This type of oven is specifically designed to heat, cook or dry food. It is not designed for industrial or laboratory use. The use of corrosive chemicals in heating or cleaning will damage the appliance and may result in radiation leaks.
8. When cleaning surfaces of door and oven that come together on closing the door, use only mild, non-abrasive soaps or detergents applied with a sponge or soft cloth.
9. Do not allow children to use this appliance, unless closely supervised by an adult.
10. Do not operate this appliance if it has a damaged cord or plug, if it is not working properly, or if it has been damaged or dropped.
11. Do not immerse cord or plug in water.
12. Keep cord away from heated surfaces.
13. Do not let cord hang over edge of table or counter.
14. This appliance should be serviced only by qualified service personnel. Contact the nearest authorized service facility for examination, repair or adjustment.
15. Some products such as whole eggs, narrow neck bottles and sealed containers—for example, closed glass jars—may explode and should not be heated in this oven.

16. To reduce the risk of fire in the oven cavity:
  - (a) Do not overcook food. Carefully attend appliance if paper, plastic, or other combustible materials are placed inside the oven to facilitate cooking.
  - (b) Remove wire twist-ties from paper or plastic bags before placing bag in oven.
  - (c) **If materials inside the oven should ignite, keep oven door closed, turn oven off, and disconnect the power cord, or shut off power at the fuse or circuit breaker panel.**
  - (d) Do not use the cavity for storage purposes. Do not leave paper products, cooking utensils, or food in the cavity when not in use.

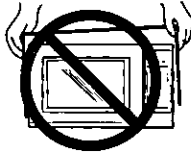
## General Use

1. **DO NOT** tamper with or make any adjustments or repairs to door, control panel housing, safety interlock switches or any other part of the oven. **DO NOT** remove outer panel from oven. Repairs should only be done by a qualified service person. 
2. **DO NOT** operate the oven empty. The microwave energy will reflect continuously throughout the oven if food or water is not present to absorb energy. This could damage the oven and result in the risk of a fire. 
3. **DO NOT** dry clothes, newspapers or other materials in oven, or use newspapers or paper bags for cooking. Fire could result.
4. **DO NOT** use recycled paper products unless the paper product is labeled as safe for microwave oven use. Recycled paper products may contain impurities which may cause sparks, and result in fires when used.
5. **DO NOT** hit or strike control panel. Damage to controls may occur. Fire could result.
6. **POT HOLDERS** should always be used when removing items from the oven. Heat is transferred from the **HOT** food to the cooking container and from the cooking container to the Glass Tray. The Glass Tray can be very **HOT** after removing cooking container from oven.
7. **DO NOT** store flammable materials next to, on top of, or in the oven. These could be fire hazards.

## SAVE THESE INSTRUCTIONS

For proper use of your oven read remaining safety cautions and operating instructions.

# Installation and GROUNDING INSTRUCTIONS

## Examine Your Oven

Unpack oven, remove all packing material, and examine the oven for any damage such as dents, broken door latches or cracks in the door. Notify dealer immediately if oven is damaged. **DO NOT** install if oven is damaged.

## Placement of Oven

- Oven must be placed on a flat, stable surface. For proper operation, the oven must have sufficient air flow. Allow 3-inches (7.6 cm) of space on both sides of the oven and 1-inch (2.5 cm) of space of space on top of oven.
  - DO NOT** block air vents. If they are blocked during operation, the oven may overheat. If the oven overheats, a thermal safety device will turn the oven off. The oven will remain inoperable until it has cooled.
  - DO NOT** place oven near a hot damp surface such as a gas or electric range.
  - DO NOT** operate oven when room humidity is too high.
- This oven was manufactured for household use only.

## Grounding Instructions

**This appliance must be grounded.** In the event of an electrical short circuit, grounding reduces the risk of electric shock by providing an escape wire for the electric current. This appliance is equipped with a cord having a grounding wire with a grounding plug. The plug must be plugged into an outlet that is properly installed and grounded.

**WARNING—Improper use of the grounding plug can result in a risk of electric shock.**

Consult a qualified electrician or service person if the grounding instructions are not completely understood, or if doubt exists as to whether the appliance is properly grounded. If it is necessary to use an extension cord, use only a three wire extension cord that has a three blade grounding plug, and a three slot receptacle that will accept the plug on the appliance. The marked rating of the extension cord should be equal to or greater than the electrical rating of the appliance.

## Power Supply

- A short power-supply cord is provided to reduce the risks resulting from becoming entangled in or tripping over a longer cord.
- Longer cord sets or extension cords are available and may be used if care is exercised in their use.
- If a long cord or extension cord is used, (1) the marked electrical rating of the cord set or extension cord should be at least as great as the electrical rating of the appliance, (2) the extension cord must be a grounding-type 3-wire cord, and (3) the longer cord should be arranged so that it will not drape over the counter top or table-top where it can be pulled on by children or tripped over accidentally.

## Wiring Requirements

- The oven must be on a SEPARATE CIRCUIT. No other appliance should share the circuit with the microwave oven. If it does, the branch circuit fuse may blow, the circuit breaker may trip, or the food may cook slower than the times recommended in this manual.
- The VOLTAGE used must be the same as specified on this microwave oven (120 V, 60 Hz). Using a higher voltage is dangerous and may result in a fire or other accident causing oven damage. Using a lower voltage will cause slow cooking. Panasonic is **NOT** responsible for damage resulting from the use of the oven with other than specified voltage.
- The oven must be plugged into at least a 20 AMP, 120 VOLT, 60 Hz GROUNDED OUTLET. Where a standard two-prong outlet is encountered, it is the personal responsibility and obligation of the consumer to have it replaced with a properly grounded three-prong outlet. 

## TV / Radio Interference

- Operation of the microwave oven may cause interference to your radio, TV or similar equipment.
- When there is interference, it may be reduced or eliminated by taking the following measures:
  - Clean door and sealing surfaces of the oven. (See Care of Your Microwave Oven)
  - Place the radio, TV, etc. away from the microwave oven as far as possible.
  - Use a properly installed antenna to obtain stronger signal reception.

## Glass Tray

- DO NOT** operate the oven without Roller Ring and Glass Tray in place.
- DO NOT** operate the oven without the Glass Tray fully engaged on the drive hub. Improper cooking or damage to the oven could result. Verify that the Glass Tray is properly engaged and rotating by observing its rotation when you press **Start**.
- Only use Glass Tray specifically designed for this oven. Do not substitute any other glass tray.
- If Glass Tray is hot, allow to cool before cleaning or placing in water.
- DO NOT** cook directly on Glass Tray. Always place food in a microwave-safe dish, or on a rack set in a microwave-safe dish.
- If food or utensil on Glass Tray touches oven walls, causing the tray to stop moving, the tray will automatically rotate in opposite direction. This is normal.
- Glass Tray can turn in either direction.

## Roller Ring

- Roller Ring and oven floor should be cleaned frequently to prevent excessive noise.
- Roller Ring must always be used for cooking along with Glass Tray.
- Always replace Roller Ring and Glass Tray in their proper positions.

# Safety Precautions

## Follow These Safety Precautions When Cooking in Your Oven

### IMPORTANT

Proper cooking depends upon the power, the time set and quantity of food. If you use a smaller portion than recommended and cook at the time for the recommended portion, fire can result.

#### 1) HOME CANNING / DRYING FOODS / SMALL QUANTITIES OF FOODS

- Do not use your oven for home canning, your oven cannot maintain the food at the proper canning temperature. Improperly canned food may spoil and be dangerous to consume.
- Do not dry meats, herbs, fruits or vegetables in your oven. Small quantities of food or foods with low moisture content can dry out, scorch or catch on fire if overheated.

#### 2) POPCORN

Popcorn may be popped in a microwave oven corn popper. Microwave popcorn which pops in its own package is also available. Follow popcorn manufacturers' directions and use a brand suitable for the wattage of your microwave oven.

**CAUTION: When using pre-packaged microwave popcorn, follow recommended package instructions. Check package weight before using the Popcorn pad (see Popcorn Pad section). Set the oven for the weight of the popcorn package.**

**If these instructions are not followed, the popcorn may not pop adequately or may ignite and cause a fire.** Never leave oven unattended when popping popcorn. Allow the popcorn bag to cool before opening, always open the bag away from your face and body.

#### 3) DEEP FAT FRYING

- Do not attempt to deep fat fry in your microwave oven. Cooking oils may burst into flames and may cause damage to the oven and perhaps result in burns. Microwave utensils may not be able to withstand the temperature of the hot oil, and could shatter or melt.

#### 4) FOODS WITH NONPOROUS SKINS

- Potatoes, apples, egg yolks, whole eggs, whole squash and sausages are examples of foods with nonporous skins. These types of foods must be pierced before microwave cooking to prevent their bursting.
- Use fresh potatoes for baking and cook until just done. Use recommended weights for programmed cooking. Overcooking causes dehydration and may result in a fire.

#### 5) LIQUIDS

- Heated liquids can erupt if not mixed with air. **DO NOT** heat liquids in your microwave oven without first stirring.

#### 6) GLASS TRAY / COOKING UTENSILS / FOIL

- Cooking utensils get hot during microwaving. Heat is transferred from the HOT food to the container and the Glass Tray. Use potholders when removing utensils from the oven or when removing lids or plastic wrap covers from cooking utensils to avoid burns.
- The glass tray will get hot during cooking. It should be allowed to cool before handling or before paper products, such as paper plates or microwave popcorn bags, are placed in the oven for microwave cooking.
- When using foil, skewers, warming rack or utensils made of metal in the oven, allow at least 1-inch (2.5 cm) of space between metal material and interior oven walls. If arcing occurs (sparking), remove metal material (skewers etc.) and/or transfer to a non-metallic container.
- Dishes with metallic trim should **not** be used, as arcing may occur.
- If an entree is heated in a foil tray, maintain at least 1-inch (2.5 cm) spacing from the oven walls.

#### 7) PAPER TOWELS / CLOTHS

- **DO NOT** use paper towels or cloths which contain a synthetic fiber woven into them. The synthetic fiber may cause the towel to ignite. Use paper toweling under supervision.

#### 8) BROWNING DISHES / OVEN COOKING BAGS

- Browning dishes or grills are designed for microwave cooking only. Always follow instructions provided by the manufacturer. **DO NOT** preheat browning dish more than 6 minutes.
- If an oven cooking bag is used for microwave cooking, prepare according to package directions. **DO NOT** use a wire twist-tie to close bag, instead use plastic ties, cotton string or a strip cut from the open end of the bag.

#### 9) THERMOMETERS

- **DO NOT** use a conventional meat thermometer in your oven. Arcing may occur. Microwave-safe thermometers are available for both meat and candy.

#### 10) BABY FORMULA / FOOD

- **DO NOT** heat baby formula or food in the microwave oven. The glass jar or surface of the food may appear warm while the interior can be so hot as to burn the infant's mouth and esophagus.

#### 11) REHEATING PASTRY PRODUCTS

- When reheating pastry products, check temperatures of any fillings before eating. Some foods have fillings which heat faster and can be extremely hot, while the surface remains warm to the touch (ex. Jelly Donuts).

#### 12) GENERAL OVEN USAGE GUIDELINES

- **DO NOT** use the oven for any reason other than the preparation of food.
- **DO NOT** leave oven unattended while in use.

## Cookware and Utensil Guide

ITEM	MICROWAVE	COMMENTS
Aluminum Foil	Yes for Shielding only	Small strips of foil can be molded around thin parts of meat or poultry to prevent overcooking. Arcing can occur if foil is too close to oven wall or if too much foil is used.
Browning Dish	Yes	Browning dishes are designed for microwave cooking only. Check browning dish information for instructions and heating chart. Do not preheat for more than 6 mins.
Brown paper bags	No	May cause a fire in the oven.
Dinnerware Labelled "Microwave-Safe" Other Dinnerware	Yes ? ?	Check manufacturers' use and care directions for use in microwave heating. Some dinnerware may state on the back of the dish, "Oven-Microwave Safe". Use CONTAINER TEST below.
Disposable polyester Paperboard Dishes	Yes	Some frozen foods are packaged in these dishes. Can be purchased in grocery stores.
Fast Food Carton with Metal Handle	No	Metal handle may cause arcing.
Frozen Dinner Tray Metal  Microwave-safe	Yes  Yes	Frozen dinners may be heated in foil tray, if tray is less than ¾ in. (2 cm) high. Place foil tray in center of oven. Leave at least 1 in. (2.5 cm) space between foil tray and oven walls. Heat only 1 foil tray in the oven at a time. For containers more than ¾ inch (2 cm) deep, remove food and place in a similar size microwave-safe container.
Glass Jars	Yes, use caution	Remove lid. Heat food until just warm, not HOT. Most glass jars are not heat resistant. Do not use for cooking.
Glassware Heat Resistant Oven Glassware & Ceramics	Yes	Ideal for microwave cooking and browning. (See CONTAINER TEST below)
Metal Bakeware	No	Not recommended for use in microwave ovens.
Metal Twist Ties	No	May cause arcing which could cause a fire in the oven.
Oven Cooking Bag	Yes	Follow manufacturers' directions. Close bag with the nylon tie provided, a strip cut from the end of the bag, or a piece of cotton string. Do not close with metal twist tie. Make six ½ in. (1 cm) slits near the closure.
Paper Plates & Cups	Yes	Use to warm cooked foods, and to cook foods that require short cooking times such as hot dogs.
Paper Towels & Napkins	Yes	Use to warm rolls and sandwiches by microwave.
Parchment Paper	Yes	Use as a cover to prevent spattering. Safe for use in microwave, microwave/convection and conventional ovens.
Plastic Microwave-Safe Cookware Reheat & Storage  Melamine	Yes  Yes, use caution  No	Should be labeled, "Suitable for Microwave Heating." Check manufacturers' directions for recommended uses. Some microwave-safe plastic dishes are not suitable for cooking foods with high fat or sugar content. The heat from hot food may cause the plastic to warp. This material absorbs microwave energy. Dishes get HOT!
Plastic Foam Cups	Yes	Plastic foam will melt if foods reach a high temperature. Use to bring foods to a low serving temperature.
Plastic Wrap	Yes	Use to cover food during cooking to retain moisture and prevent spattering. Should be labelled "Suitable for Microwave Heating". Check package directions.
Straw, Wicker, Wood	Yes	Use only for short term reheating and to bring food to a low serving temperature.
Thermometers Microwave-safe, only Conventional	Yes  No	Use only microwave-safe meat and candy thermometers. Not suitable for use in microwave oven, will cause sparks and get hot.
Wax paper	Yes	Use as a cover to prevent spattering and to retain moisture.

**TO TEST A CONTAINER FOR SAFE MICROWAVE OVEN USE:** Fill a 1- cup glass measure with water and place it in the microwave oven along with the container to be tested; **heat one (1) minute at HIGH.** If the container is microwave oven-safe, the container should remain comfortably cool and the water should be hot. If the container is hot, it has absorbed some microwave energy and should NOT be used. This test cannot be used for plastic containers.

## Feature Diagram

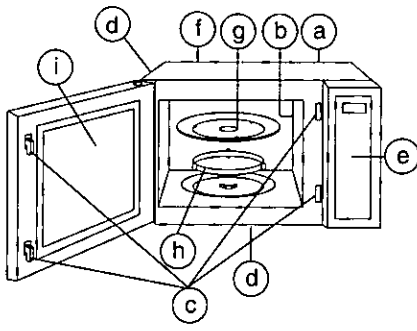

- (a) External Air Vents
- (b) Internal Air Vents
- (c) Door Safety Lock System
- (d) Exhaust Air Vents
- (e) Control Panel
- (f) Identification Plate
- (g) Glass Tray
- (h) Roller Ring
- (i) Heat/Vapor Barrier Film  
(do not remove)

## Control Panel

NN-S540

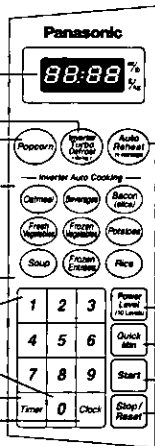

- (1) Display Window
- (2) Inverter Turbo Defrost Pad
- (3) Popcorn Pad
- (4) Inverter Auto Cooking Pads
- (5) Number Pads
- (6) Timer Pad
- (7) Clock Pad
- (8) Auto Reheat Pad
- (9) Serving/Weight Pad
- (10) Power Level Pad
- (11) Quick Min Pad
- (12) Start Pad
- (13) Stop/Reset Pad

NN-L530

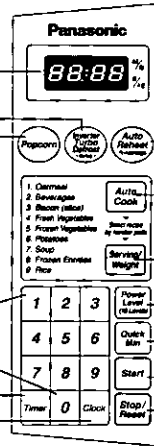

- (1) Display Window
- (2) Inverter Turbo Defrost Pad
- (3) Popcorn Pad
- (4) Air Fry Cook
- (5) Number Pads
- (6) Timer Pad
- (7) Clock Pad
- (8) Auto Reheat Pad
- (9) Serving/Weight Pad
- (10) Power Level Pad
- (11) Quick Min Pad
- (12) Start Pad
- (13) Stop/Reset Pad

**(1) Display Window**

Step by step instructions scroll for easy operation.

**(2) Inverter Turbo Defrost Pad**

(☛ page 8)

**(3) Popcorn Pad**

(☛ page 8)

**(4) Inverter Auto Cooking Pads**

(☛ page 10-11)

**(5) Number Pads**

**(6) Timer Pad**

(☛ page 12)

**(7) Clock Pad**

(☛ pages 7)

**(8) Auto Reheat Pad**

(☛ page 10)

**(9) Serving/Weight Pad**

(☛ page 10)

**(10) Power Level Pad**

(☛ page 7)

**(11) Quick Min Pad**

(☛ page 7)

**(12) Start Pad**

One tap allows oven to begin functioning. If door is opened or **Stop/Reset** Pad is pressed once during oven operation, **Start** Pad must be pressed again to restart oven.

**(13) Stop/Reset Pad**

**Before cooking:** One tap clears your instruction.

**During cooking:** One tap temporarily stops the cooking process. Another tap cancels all your instructions and time of day or color appears on the display window.

**Beep Sound:**

When a pad is pressed correctly, a beep will be heard.



If a pad is pressed and no beep is heard, the unit did not or cannot accept the instruction.

The oven will beep twice between programmed stages. At the end of any complete program, the oven will beep 5 times.

## Clock Setting

You can use the oven without setting the clock.

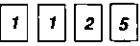
**Example: To set 11:25 a.m. or p.m.**

1. 	<ul style="list-style-type: none"> <li>Press once.</li> <li>➤ Colon will blink.</li> </ul>
2. 	<ul style="list-style-type: none"> <li>Enter time of day using the number pads.</li> <li>➤ Time appears on the Display Window; colon is blinking.</li> </ul>
3. 	<ul style="list-style-type: none"> <li>Press.</li> <li>➤ Colon stops blinking; time of day is entered and locked onto the Display Window.</li> </ul>



### NOTES:

- To reset time of day, repeat steps 1- 3.
- The clock will keep the time of day as long as oven is plugged in and electricity is supplied.
- Clock is a 12 hour display.
- Oven will not operate while colon is blinking.

## Quick Min Function

This feature allows you to set and/or add cooking times easily in multiples of one minute.

### To Set Standing Time:

1. 	<ul style="list-style-type: none"> <li>Set cooking time (up to 10 taps/minutes)</li> </ul>
2. 	<ul style="list-style-type: none"> <li>Press <b>Start</b> Pad.</li> <li>➤ Cooking will start on P10(HIGH) power.</li> </ul>



### NOTE:

- You can use other power levels, select desired power level before setting cooking time.
- After setting the time by **Quick Min** Pad, you cannot use Number Pads, and vice versa.
- Press **Quick Min** Pad to add more time during cooking. To verify the additional cooking time, check the **Display Window**.

## Power & Time Setting

How do I program Power and Time?

**Example: To cook at P 6 (MEDIUM) Power for 1 minute 30 seconds**

1.  Press 5 times.	<ul style="list-style-type: none"> <li>Select <b>Power Level</b>. (according to the chart below)</li> </ul>
2. 	<ul style="list-style-type: none"> <li>Set Cooking Time using number pads.</li> </ul>
3. 	<ul style="list-style-type: none"> <li>Press.</li> <li>➤ Cooking will start. The time on the screen will count down.</li> </ul>



Press	Power Level
once	P10 (HIGH)
twice	P 9
3 times	P 8
4 times	P 7 (MEDIUM-HIGH)
5 times	P 6 (MEDIUM)
6 times	P 5
7 times	P 4
8 times	P 3 (MEDIUM-LOW)
9 times	P 2
10 times	P 1 (LOW)

### NOTES:

- For more than one stage cooking, repeat steps 1 and 2 for each stage of cooking before pressing **Start** Pad.
- When selecting P10 (HIGH) power for the first stage, you may begin at step 2.
- Two beeps will sound between each stage of programming. Five beeps will sound at the end of the entire sequence.
- When selecting P10 (HIGH) power, the maximum programmable time is 30 minutes. For other power levels, the maximum time is 99 minutes and 99 seconds.
- For reheating, use P10 (HIGH) for liquids, P7 (MEDIUM-HIGH) for most foods and P6 (MEDIUM) for dense foods.
- For defrosting, use P3 (MEDIUM-LOW).

## Popcorn Function

**Example: To heat 1.75 oz. of Popcorn**

<p><b>1.</b></p>  <p>Press once</p>	<ul style="list-style-type: none"> <li>Set the desired weight of prepackaged microwave popcorn.</li> </ul> <table border="1" style="width: 100%;"> <thead> <tr> <th>Press</th> <th>Weight</th> </tr> </thead> <tbody> <tr> <td>once</td> <td>1.75 oz. (50g)</td> </tr> <tr> <td>twice</td> <td>2.65 oz. (75g)</td> </tr> <tr> <td>3 times</td> <td>2.85 oz. (80g)</td> </tr> <tr> <td>4 times</td> <td>3.0 oz. (90g)</td> </tr> <tr> <td>5 times</td> <td>3.5 oz. (99g)</td> </tr> </tbody> </table>	Press	Weight	once	1.75 oz. (50g)	twice	2.65 oz. (75g)	3 times	2.85 oz. (80g)	4 times	3.0 oz. (90g)	5 times	3.5 oz. (99g)
Press	Weight												
once	1.75 oz. (50g)												
twice	2.65 oz. (75g)												
3 times	2.85 oz. (80g)												
4 times	3.0 oz. (90g)												
5 times	3.5 oz. (99g)												
<p><b>2.</b></p> 	<ul style="list-style-type: none"> <li>Press <b>Start</b> Pad.</li> <li>▶Cooking time appears in the display and begins to count down.</li> </ul>												

### NOTES ON POPCORN PAD:



- Use prepackaged **room temperature** microwave popcorn. Read manufacturers' instructions.
- Place bag in oven according to manufacturers' directions.
- Pop only one bag at a time.
- After popping, allow the contents of the bag to cool for a few minutes before opening. Open bag carefully away from face and body because popcorn and steam are extremely hot.
- Do not reheat unpopped kernels or reuse bag.
- NEVER** leave oven unattended when popping popcorn.

**CAUTION:** If pre-packaged popcorn is a different weight than is recommended, do not use the popcorn setting, or inadequate popping or a fire may occur. Follow the manufacturers' instructions.

## Inverter Turbo Defrost

This feature allows you to defrost meat, poultry and seafood simply by entering the weight.

**Example: To defrost 1.5 pounds of meat.**

<p><b>1.</b></p> 	<ul style="list-style-type: none"> <li>Press.</li> </ul>
<p><b>2.</b></p> 	<ul style="list-style-type: none"> <li>Enter weight of the food using the number pads. Weight must be programmed in pounds and tenths of a pound. (See conversion chart below.)</li> </ul>
<p><b>3.</b></p> 	<ul style="list-style-type: none"> <li>Press.</li> <li>▶Defrosting will start. The time on the screen will count down.</li> </ul>

### Conversion Chart:

Follow the chart to convert ounces or hundredths of a pound into tenths of a pound. To use Auto Defrost, program the weight of the food in lbs. (1.0) and tenths of a lb. (0.1). If a piece of meat weighs 1.95 lbs. or 1 lb. 14 oz., program 1.9 lbs. If a piece of meat weighs 1.99 lbs. or 2 lbs. 0 oz., program 2.0 pounds.

Ounces	Hundredths of a Pound	Tenths of a Pound
0	.96 - .05	0.0
1 - 2	.06 - .15	0.1
3 - 4	.16 - .25	0.2
5	.26 - .35	0.3
6 - 7	.36 - .45	0.4
8	.46 - .55	0.5
9 - 10	.56 - .65	0.6
11 - 12	.66 - .75	0.7
13	.76 - .85	0.8
14 - 15	.86 - .95	0.9

## Defrosting Tips & Techniques



1. Freeze meats, poultry and fish in packages with only 1 or 2 layers of food. Place wax paper between layers.
2. Package in heavy-duty plastic wraps, bags or freezer paper.
3. Remove as much air as possible.
4. Wrap should be snug against food, sealed securely and labeled.
5. Remove wrapper to prevent holding steam and juice. Juice of food can get hot and cause the outer surface or bottom of the food to cook; set the food on a microwave roasting rack and drain liquid during defrosting.
6. Place meat in an appropriate size dish.
7. Place roast fat-side down and whole poultry breast-side down on a microwave roasting rack in a dish.
8. Place small items on a microwave roasting rack in a dish.
9. Large roasts and whole poultry may still be icy in center after defrosting, allow to stand in the refrigerator covered with plastic wrap (see chart below).
10. Fish and seafood should be slightly icy after defrosting, allow to stand and rinse under cold water for 2-3 minutes.
11. Defrosted items in 2 layers should be rinsed separately or have a longer stand time.

FOOD	DEFROST TIME at P3 (min./lb.)	DURING DEFROSTING	AFTER DEFROSTING	
			Stand Time	Rinse
<b>Fish and Seafood</b> [up to 3 lb. (1.4 kg)]				
Crabmeat	6	Break apart/Rearrange	5 min.	YES
Fish Steaks	4 to 6	Turn over		
Fish Fillets	4 to 6	Turn over/Rearrange/Shield ends		
Sea Scallops	4 to 6	Break apart/Rearrange/ Remove defrosted pieces		
Whole fish	4 to 6	Turn over		
<b>Meat</b>				
Ground Meat	4 to 5	Turn over/Remove defrosted portion/ Shield edges	10 min.	NO
Roasts [2½-4 lb.(1.1-1.8 kg)]	7 to 8	Turn over/Shield ends and defrosted surface	30 min. in refrig.	
Chops/Steak	6 to 8	Turn over/Rearrange/Shield ends and defrosted surface	5 min.	
Ribs/T-bone	6 to 8	Turn over/Rearrange/Shield ends and defrosted surface		
Stew Meat	4 to 8	Break apart/Rearrange/Remove defrosted pieces		
Liver (thin sliced)	4 to 6	Drain liquid/Turn over/ Separate pieces/Shield eggs		
Bacon (sliced)	4	Turn over		
<b>Poultry</b>				
Chicken, Whole [up to 3 lb. (1.4 kg)]	4 to 6	Turn over/Shield	20 min. in refrig.	YES
Cutlets	4 to 6	Break apart/Turn over/ Remove defrosted pieces	5 min.	
Pieces	4 to 6	Break apart/Turn over/Shield		
Cornish Hens	6 to 8	Turn over/Shield	10 min.	
Turkey Breast [5-6 lbs.(2.3-2.7 kg)]	6	Turn over/Shield	20 min. in refrig.	

## Auto Reheat

This feature allows you to reheat 1 to 4 servings of precooked room temperature and refrigerator temperature foods without setting power and time.

### Example: To reheat 2 cups of soup

1.  Press twice.	• Press until the desired number of servings appears in the <b>Display Window</b> .
2. 	• Press. ▶ Cooking time appears in the <b>Display Window</b> and begins to count down.

#### NOTES:

1. **Auto Reheat** can be programmed for 1 to 4 servings.
2. The following are the recommended food items and approximate weights.

Foods	No. of Servings	Serving Size	Starting Temp.
Plate of Food	3 - 4	12 - 16 oz.	Refrig.
Meat, Poultry	1 - 4	4-6 oz. ea.	Refrig.
Casseroles	1 - 2	8 oz.	Refrig.
Side Dishes	1 - 4	4-6 oz. ea.	Refrig or Room
Soups, Sauces, Gravy	1 - 2	4-6 oz. ea.	Refrig. or Room





#### For best results follow these recommendations:

1. All foods must be previously cooked.
2. Foods should always be covered loosely with plastic wrap, wax paper or casserole lid.
3. All foods should have a covered stand time of 3 to 5 minutes.
4. **DO NOT** reheat bread and pastry products. Use manual power and time.
5. **DO NOT** reheat beverages.

## Inverter Auto Cooking (NN-L530)



These are tested and pre-timed (based on the power rating of this oven) for the quantity of food listed in the chart on page 11. Locale, power fluctuations and personal tastes are not taken into account. Should you prefer your food cooked differently, use power and time method shown on page 7.

### Example: To cook a 10 oz. Frozen Entrée

1. 	• Press.
2. 	• Select the desired category number using the number pads.
3. 	• Press until the desired quantity appears on the <b>Display Window</b> .
4. 	• Press. ▶ Cooking time appears in the <b>Display Window</b> and begins to count down.

## Inverter Auto Cooking (NN-S540)

### Example: To cook a 10 oz. Frozen Entrée

1.  Press twice.	• Press until the desired serving/weight appears in the <b>Display Window</b> .
2. 	• Press. ▶ Cooking time appears in the <b>Display Window</b> and begins to count down.

## Inverter Auto Cooking



The following chart is the recommended serving/weights for Inverter Auto Cooking.

Pad	Serving/Weight	Hints
<b>1.Oatmeal</b>	½, 1 cup	Place inside a microwave-safe serving bowl with no cover. Follow manufacturers' directions for preparation of quick oatmeal.
<b>2.Beverages</b>	1, 2 cups	Use a microwave-safe coffee cup. Heated liquids can erupt if not mixed with air. Do not heat liquids in your microwave oven without stirring first.
<b>3.Bacon (slice)</b>	4, 6, 10, 14 slices	Place slices of bacon on a microwave-safe dish. Cover with paper towel. Times may vary by brand (weight).
<b>4.Fresh Vegetables</b>	4, 8, 12, 16 oz.	All pieces should be the same size. Add a small amount of water and cover loosely with lid or vented plastic wrap.
<b>5.Frozen Vegetables</b>	6, 10, 16 oz.	Follow manufacturers' directions. Do not salt until after cooking. Not suitable for vegetables in butter or sauce.
<b>6.Potatoes</b>	1, 2, 3, 4 pieces (6 to 8 oz. each)	Pierce skin with fork 6 times on top. Place potatoes on a microwave-safe dish. Do not cover. Let stand 5 minutes to complete cooking.
<b>7.Soup</b>	1, 2 cups	Pour soup into a microwave-safe serving bowl. Cover loosely with lid or vented plastic wrap.
<b>8.Frozen Entrées</b>	8, 10, 20, 32 oz.	Follow manufacturers' directions for covering or removing covers. For best results, do not use frozen foods packaged in foil tray.
<b>9.Rice</b>	½, 1, 1½ cups	Place rice with hot water in a microwave-safe casserole dish. Cover loosely with lid or vented plastic wrap. Let stand 5 to 10 minutes before serving.







## Timer Setting

This feature allows you to program a Standing Time after cooking is completed and to program the oven as a minute timer and/or to program a delay start.





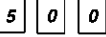

### To Use as a Kitchen Timer:

<b>Example: To count 5 minutes</b>	
<b>1.</b>	 <ul style="list-style-type: none"> <li>• Press.</li> </ul>
<b>2.</b>	 <ul style="list-style-type: none"> <li>• Set desired amount of time using number pads. (up to 99 minutes and 99 seconds).</li> </ul>
<b>3.</b>	 <ul style="list-style-type: none"> <li>• Press.</li> <li>▶ Time will count down without oven operating.</li> </ul>

### To Set Stand Time:

<b>Example: To stand for 5 mins. after cooking (3 mins. at MEDIUM Power)</b>	
<b>1.</b>	 <p style="text-align: center;">5 times</p>   <ul style="list-style-type: none"> <li>• Enter the desired cooking program (see page 7 for directions).</li> </ul>
<b>2.</b>	 <ul style="list-style-type: none"> <li>• Press once.</li> </ul>
<b>3.</b>	 <ul style="list-style-type: none"> <li>• Set desired amount of Stand Time using number pads. (up to 99 minutes and 99 seconds)</li> </ul>
<b>4.</b>	 <ul style="list-style-type: none"> <li>• Press.</li> <li>▶ Cooking will start. After cooking, stand time will count down without oven operating.</li> </ul>

### To Set Delay Start:

<b>Example: To start cooking 5 minutes later. (3 mins. at MEDIUM Power).</b>	
<b>1.</b>	 <ul style="list-style-type: none"> <li>• Press once.</li> </ul>
<b>2.</b>	 <ul style="list-style-type: none"> <li>• Enter desired amount of delayed time using number pads. (up to 99 minutes and 99 seconds)</li> </ul>
<b>3.</b>	 <p style="text-align: center;">5 times</p>   <ul style="list-style-type: none"> <li>• Enter the desired cooking program (see page 7 for directions).</li> </ul>
<b>4.</b>	 <ul style="list-style-type: none"> <li>• Press.</li> <li>▶ Delayed time will count down. Then cooking will start.</li> </ul>

#### NOTES:

1. If oven door is opened during Stand Time or Kitchen Timer, the time on the screen will continue to count down.
2. Delay time cannot be programmed before any Auto Control Function. This is to prevent the starting temperature of food from rising before defrosting or cooking begins. A change in starting temperature could cause inaccurate results.

## Microwave Shortcuts

FOOD	POWER	TIME (in mins.)	DIRECTIONS
To separate <b>Bacon</b> , 1 pound (450 g)	P10 (High)	30 sec.	Remove wrapper and place in microwave safe dish. After heating, use a plastic spatula to separate slices.
To soften <b>Brown Sugar</b> 1 cup (250 mL)	P10 (High)	20 - 30 sec.	Place brown sugar in microwave safe dish with a slice of bread. Cover with plastic wrap.
To soften <b>Butter</b> , 1 stick, ¼ pound (110 g)	P3 (MED.-LOW)	1	Remove wrapper and place butter in a microwave-safe dish.
To melt <b>Butter</b> , 1 stick ¼ pound (110 g)	P6 (MEDIUM)	1½ - 2	Remove wrapper and place butter in a microwave-safe dish covered with plastic wrap.
To melt <b>Chocolate</b> , 1 square, 1 oz. (28 g)	P10 (High)	1 - 1½	Remove wrapper and place chocolate in a microwave-safe dish. Stir before adding more time. (Stir until completely melted.) <i>Note: Chocolate holds its shape even when softened.</i>
To melt <b>Chocolate</b> , ½ cup (125 mL) chips	P10 (High)	1 - 1½	
To toast <b>Coconut</b> , ½ cup (125 mL)	P10 (High)	1	Place in a microwave-safe dish. Stir every 30 seconds.
To soften <b>Cream Cheese</b> , 8 oz. (250 g)	P3 (MED.-LOW)	1 - 2	Remove wrapper and place in a microwave-safe bowl.
To brown <b>Ground Beef</b> , 1 pound (450 g)	P10 (High)	4 - 5	Crumble into a microwave-safe colander set into another dish. Stir twice. Drain grease.
To steam <b>Hand Towels</b> - 4	P10 (High)	20 - 30 sec.	Soak in water, then wring out excess. Place on a microwave-safe dish. Heat. Present immediately.
To soften <b>Ice Cream</b> , ½ gallon, 2qt. (2L)	P3 (MED.-LOW)	1 - 1½	Check often to prevent melting.
Cup of liquid <b>boiling water, broth, etc.</b> 1 cup, 8 oz. (250 mL) 2 cups, 16 oz. (500 mL) to heat <b>milk</b> 1 cup, 8 oz. (250 mL) 2 cups, 16 oz. (500 mL)	P10 (High)  P7 (MED.-HIGH)	 2⅓ - 3 4  2 - 3 4 - 5	Heated liquids can erupt if not stirred. Do not heat liquids in microwave oven without stirring before and after heating.
To roast <b>Nuts</b> , 1½ cups (375 mL)	P10 (High)	4 - 5	Spread nuts into a 9-inch (230 mm) microwave-safe pie plate. Stir occasionally.
To toast <b>Sesame Seeds</b> , ¼ cup (50 mL)	P10 (High)	3 - 5	Place in a small microwave-safe bowl. Stir twice.
To skin <b>Tomatoes</b> (one at a time)	P10 (High)	30 sec.	Place tomato into a microwave-safe bowl containing boiling water. Rinse and peel. Repeat for each tomato.
To remove <b>Cooking Odors</b>	P10 (High)	5	Combine 1 to 1½ cups (250 - 375 mL) water with the juice and peel of one lemon in a small microwave-safe bowl. After heating, wipe interior of oven with damp cloth.

## Food Characteristics

### Bone and Fat

Both bone and fat affect cooking. Bones may cause irregular cooking. Meat next to the tips of bones may overcook while meat positioned under a large bone, such as a ham bone, may be undercooked. Large amounts of fat absorb microwave energy and the meat next to these areas may overcook.

### Density

Porous, airy foods such as breads, cakes or rolls take less time to cook than heavy, dense foods such as potatoes and roasts. When reheating donuts or other foods with different centers be very careful. Certain foods have centers made with sugar, water or fat and these centers attract microwaves (For ex., jelly donuts). When a jelly donut is heated, the jelly can become extremely hot while the exterior remains warm to the touch. This could result in a burn if the food is not allowed to cool properly in the center.

### Quantity

Two potatoes take longer to cook than one potato. As the quantity of the food increases so does the cooking time. When cooking small amounts of food such as one or two potatoes, do not leave oven unattended. The moisture content in the food may decrease and a fire could result.

### Shape

Uniform sizes heat more evenly. The thin end of a drumstick will cook more quickly than the meaty end. To compensate for irregular shapes, place thin parts toward the center of the dish and thick pieces toward the edge.

### Size

Thin pieces cook more quickly than thick pieces.

### Starting Temperature

Foods that are room temperature take less time to cook than if they are chilled or refrigerated or frozen.

## Cooking Techniques

### Piercing

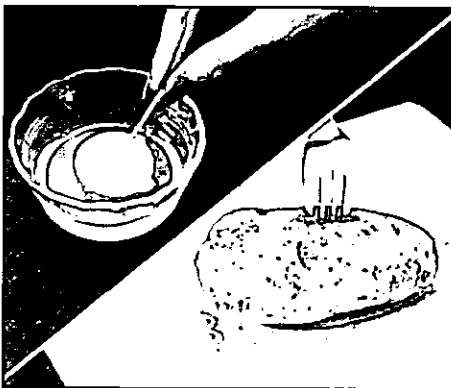

Foods with skins or membranes must be pierced, scored or have a strip of skin peeled before cooking to allow steam to escape. Pierce whole egg yolks and whites, clams, oysters, chicken livers, whole potatoes and whole vegetables. Whole apples or new potatoes should have a 1-inch strip of skin peeled before cooking. Score sausages and frankfurters.

### Browning



Foods will not have the same brown appearance as conventionally cooked foods or these foods which are cooked utilizing a browning feature. Meats and poultry may be coated with browning sauce, Worcestershire sauce, barbecue sauce or shake-on browning sauce. To use, combine browning sauce with melted butter or margarine; brush on before cooking. For quick breads or muffins, brown sugar can be used in the recipe in place of granulated sugar, or the surface can be sprinkled with dark spices before baking.

## Cooking Techniques

### Spacing

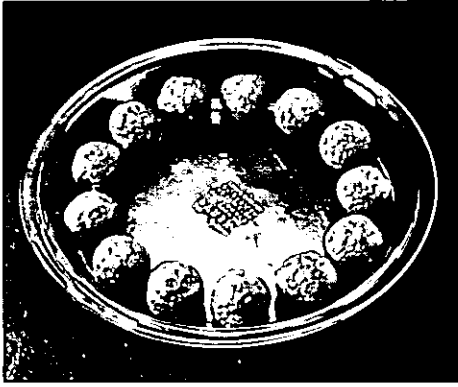

Individual foods, such as baked potatoes, cupcakes and appetizers, will cook more evenly if placed in the oven equal distances apart. When possible, arrange foods in a circular pattern.

### Covering

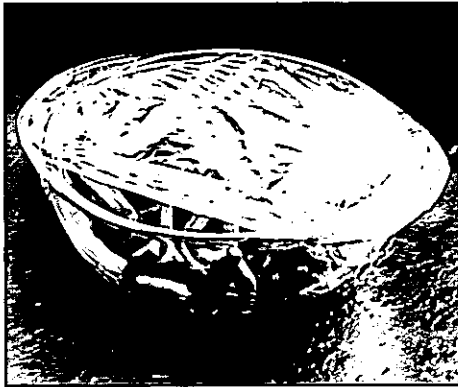

As with conventional cooking, moisture evaporates during microwave cooking. Casserole lids or plastic wrap are used for a tighter seal. When using plastic wrap, vent the plastic wrap by folding back part of the plastic wrap from the edge of the dish to allow steam to escape. Loosen or remove plastic wrap as recipe directs for stand time. When removing plastic wrap covers, as well as any glass lids, be careful to remove them away from you to avoid steam burns. Various degrees of moisture retention are also obtained by using wax paper or paper towels. However, unless specified, a recipe is cooked covered.

## Cooking Techniques

### Shielding

Thin areas of meat and poultry cook more quickly than meaty portions. To prevent overcooking, these thin areas can be shielded with strips of aluminum foil. Wooden toothpicks may be used to hold the foil in place.

### Timing

A range in cooking time is given in each recipe. The time range compensates for the uncontrollable differences in food shapes, starting temperature and regional preferences. Always cook food for the minimum cooking time given in a recipe and check for doneness. If the food is undercooked, continue cooking. It is easier to add time to an undercooked product. Once the food is overcooked, nothing can be done.

### Stirring

Stirring is usually necessary during microwave cooking. We have noted when stirring is helpful, using the words once, twice, frequently or occasionally to describe the amount of stirring necessary. Always bring the cooked outside edges toward the center and the less cooked center portions toward the outside of the dish.

### Rearranging

Rearrange small items such as chicken pieces, shrimp, hamburger patties or pork chops. Rearrange pieces from the edge to the center and pieces from the center to the edge of the dish.

### Turning

It is not possible to stir some foods to redistribute the heat. At times, microwave energy will concentrate in one area of a food. To help insure even cooking, these foods need to be turned. Turn over large foods, such as roasts or turkeys, halfway through cooking.

### Stand Time

Most foods will continue to cook by conduction after the microwave oven is turned off. In meat cookery, the internal temperature will rise 5°F to 15°F (3°C to 8°C), if allowed to stand, tented with foil, for 10 to 15 minutes. Casseroles and vegetables need a shorter amount of standing time, but this standing time is necessary to allow foods to complete cooking to the center without overcooking on the edges.

### Turning

The same tests for doneness used in conventional cooking may be used for microwave cooking. Meat is done when fork-tender or splits at fibers. Chicken is done when juices are clear yellow and drumstick moves freely. Fish is done when it flakes and is opaque. Cake is done when a toothpick or cake tester is inserted and comes out clean. Candy is done when it reaches the proper temperature for each stage of crystallization.

## Care of Your Microwave

### BEFORE CLEANING:

Unplug at socket of the oven. If impossible, leave oven door open to prevent oven from accidentally turning on.

### AFTER CLEANING:

Be sure to replace the Roller Ring and Glass Tray in the proper position and press **Stop/Reset** Pad to clear the screen.

#### Inside of the oven:

Wipe with a damp cloth. Mild detergent may be used if the oven gets very dirty. The use of harsh detergent or abrasives is not recommended.

#### Glass Tray:

Remove and wash in warm soapy water or in a dishwasher.

#### Outside oven surfaces.

Clean with a damp cloth. To prevent damage to the operating parts inside the oven, water should not be allowed to seep into ventilation openings.

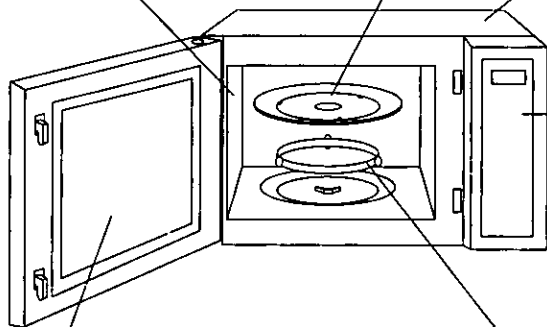

#### Control Panel:

- \* Covered with a removable protective film to prevent scratches during shipping. Small bubbles may appear under this film. (Hint - To remove film, apply masking or clear tape to an exposed corner and pull gently.)
- \* If the control panel becomes wet, clean it with a soft dry cloth. Do not use harsh detergents or abrasives on the Control Panel.

#### Oven Door:

Wipe with a soft cloth when steam accumulates inside or around the outside of the oven door. During cooking, especially under high humidity conditions, steam is given off from the food. (Some steam will condense on cooler surfaces, such as the oven door.) This is normal.

#### Roller Ring and oven cavity floor:

Wipe the bottom surface of the oven with mild detergent water or window cleaner and dry. Roller Ring may be washed in mild soapy water or dishwasher. These areas should be kept clean to avoid excessive noise.

## ORDER FORM

For more information regarding microwave cooking, order our new **COOKING GUIDE** (68 pages of recipes & charts).

### DESCRIPTION

### PART NUMBER

Instruction / Operating Manual (this book)	F00034T20AP
COOKING GUIDE	B000B8250AP
Glass Tray	A06014T00AP
Roller Ring Assembly	B290D9330AP

For pricing quotes, call or write the Parts & Literature Department at the phone or address listed below. Please have your credit card information readily available.

*Shipping & handling are not included. Price & availability subject to change. Sorry, no COD's.*

PANASONIC SERVICES COMPANY  
20421 84th Avenue South  
Kent, WA 98032

(800) 833-9626 - Phone  
(800) 237-9080 - FAX

You can purchase parts, accessories or locate your nearest servicenter by visiting our Web Site:  
**Web Site: <http://www.Panasonic.com>**

## Before Requesting Service

### All these things are normal:

The oven causes interference with my TV.

Some radio and TV interference might occur when you cook with the microwave oven. This interference is similar to the interference caused by small appliances such as mixers, vacuums, blow dryers, etc. It does not indicate a problem with your oven.

Steam accumulates on the oven door and warm air comes from the oven vents.

During cooking, steam and warm air are given off from the food. Most of the steam and warm air are removed from the oven by the air which circulates in the oven cavity. However, some steam will condense on cooler surfaces such as the oven door. This is normal.

I accidentally ran my microwave oven without any food in it.

Running the oven empty for a short time will not damage the oven. However, we do not recommend operating the microwave oven without any food in it.

#### PROBLEM

#### POSSIBLE CAUSE

#### REMEDY

Oven will not turn on.



The oven is not plugged in securely.

Remove plug from outlet, wait 10 seconds and reinsert.

Circuit breaker or fuse is tripped or blown.

Reset circuit breaker or replace fuse.

There is a problem with the outlet.

Plug another appliance into the outlet to check if it is working.

Oven will not start cooking.



The door is not closed completely.

Close the oven door securely.

**Start** Pad was not pressed after programming.

Press **Start** Pad.

Another program entered already in the oven.

Press **Stop/Reset** Pad to cancel the previous program and program again.

The program is not correct.

Program again according to the Operating Instructions.

**Stop/Reset** Pad has been pressed accidentally.

Program oven again.

When the oven is turning on, there is noise coming from the glass tray.



The roller ring and oven bottom are dirty.

Clean these parts according to **Care of Your Oven**.

## Warranty & Service

### PANASONIC MICROWAVE OVEN LIMITED WARRANTY

Panasonic Consumer Electronics Company or Panasonic Sales Company (collectively referred to as "the warrantor") will repair this product with new or refurbished parts in exchange for defective parts, free of charge, in the USA or Puerto Rico from the date of original purchase in the event of a defect in materials or workmanship as follows (all time periods start from the date of original purchase):

**Parts** - one (1) year (except magnetron).

**Magnetron Tube** - five (5) years.

**Labor** - one (1) year on all parts (including, without limitations, magnetron tube). After the labor warranty has expired, the purchaser pays for all labor charges for removal and installation of parts (including, without limitation, magnetron tube).

Carry-in or mail-in service in the USA or Puerto Rico can be obtained during the warranty period by contacting a Panasonic Services Company (PASC) Factory Servicenter listed in the Servicenter Directory. Or call, toll free, **1-800-211-PANA** to locate a PASC authorized Servicenter. Carry-in or mail-in service in Puerto Rico can be obtained during the warranty period by calling the Panasonic Sales Company telephone number listed in the Servicenter Directory.

This warranty is extended only to the original purchaser. A purchase receipt or other proof of date of original purchase will be required before warranty service is rendered.

This warranty only covers failures due to defects in materials or workmanship which occur during normal use and does not cover glass, plastic parts, temperature probes (if included), and the exterior and interior finish. The warranty does not cover damages which occur in shipment, or failures which are caused by products not supplied by the warrantor, or failures

which result from accident, misuse, abuse, neglect, mishandling, misapplication, faulty installation, improper set-up adjustments, operation and/or maintenance, or alteration, modification, power line surge, improper voltage supply, lightning damage, or commercial use such as hotel, office, restaurant or other business or rental use of the product, or service by anyone other than a PASC Factory Servicenter or a PASC authorized Servicenter, or damage that is attributable to acts of God.

#### LIMITS AND EXCLUSIONS

There are no express warranties except as listed above.

THE WARRANTOR SHALL NOT BE LIABLE FOR INCIDENTAL OR CONSEQUENTIAL DAMAGES RESULTING FROM THE USE OF THIS PRODUCT, OR ARISING OUT OF ANY BREACH OF THIS WARRANTY. ALL EXPRESS AND IMPLIED WARRANTIES, INCLUDING THE WARRANTIES OF MERCHANTABILITY, AND FITNESS FOR A PARTICULAR PURPOSE, ARE LIMITED TO THE APPLICABLE WARRANTY PERIOD SET FORTH ABOVE.

Some states do not allow the exclusion or limitation of incidental or consequential damages, or limitations on how long an implied warranty lasts, so the above exclusions or limitations may not apply to you.

This warranty gives you specific legal rights and you may also have other rights which vary from state to state. If a problem with this product develops during or after the warranty period, you may contact your dealer or Servicenter. If the problem is not handled to your satisfaction, then write to the Customer Satisfaction Center.

#### Factory Servicenters Locations

**CALIFORNIA**  
6550 Katella Ave.  
Cypress, CA 90630

800 Dubuque Ave.  
S. San Francisco,  
CA 94080

20201 Sherman Way  
Suite 102  
Canoga Park, CA 91306

3878 Ruffin Rd., Suite A  
San Diego, CA 92123

**COLORADO**  
1640 South Abilene St.  
Suite D  
Aurora, CO 80012

**FLORIDA**  
3700 North 29th Ave.  
Suite 102  
Hollywood, FL 33020

**GEORGIA**  
8655 Roswell Road  
Suite 100  
Atlanta, GA 30350

**ILLINOIS**  
9060 Golf Road  
Niles, IL 60714

1703 N. Randall Road  
Elgin, IL 60123  
(Pick up/Drop off only)

**MARYLAND**  
62 Mountain Road  
Glen Burnie, MD 21061

**MASSACHUSETTS**  
60 Glacier Drive, Suite G  
Westwood, MA 02090

**MICHIGAN**  
37048 Van Dyke Ave.  
Sterling Hts., MI 48312

**MINNESOTA**  
7850-12th Ave. South  
Airport Business Center  
Bloomington, MN 55425

**OHIO**  
2236 Waycross Road  
Civic Center Plaza  
Forest Park, OH 45240

**PENNSYLVANIA**  
2221 Cabot Blvd. West  
Suite B  
Langhorne, PA 19047

**TENNESSEE**  
3800 Ezell Road  
Suite 806  
Nashville, TN 37211

**TENNESSEE**  
13615 Welch Road  
Suite 101  
Farmers Branch,  
TX 75244

**WASHINGTON**  
20425-84th Ave. So.  
Kent, WA 98032

**HAWAII**  
99-859 Iwaiwa Street  
Aiea, Hawaii 96701  
Phone (808) 488-1996  
Fax (808) 486-4639

**Puerto Rico:** Matsushita Electric of Puerto Rico, Inc. Panasonic Sales Company / Factory Servicenter  
Ave. 65 de Infanteria, Km. 9.5, San Gabriel Industrial Park, Carolina, Puerto Rico 00985  
Phone (787) 750-4300 Fax (787) 768-2910