

Panasonic®

Operating Instructions

Microwave Oven
Model NN-L728 / NN-L628

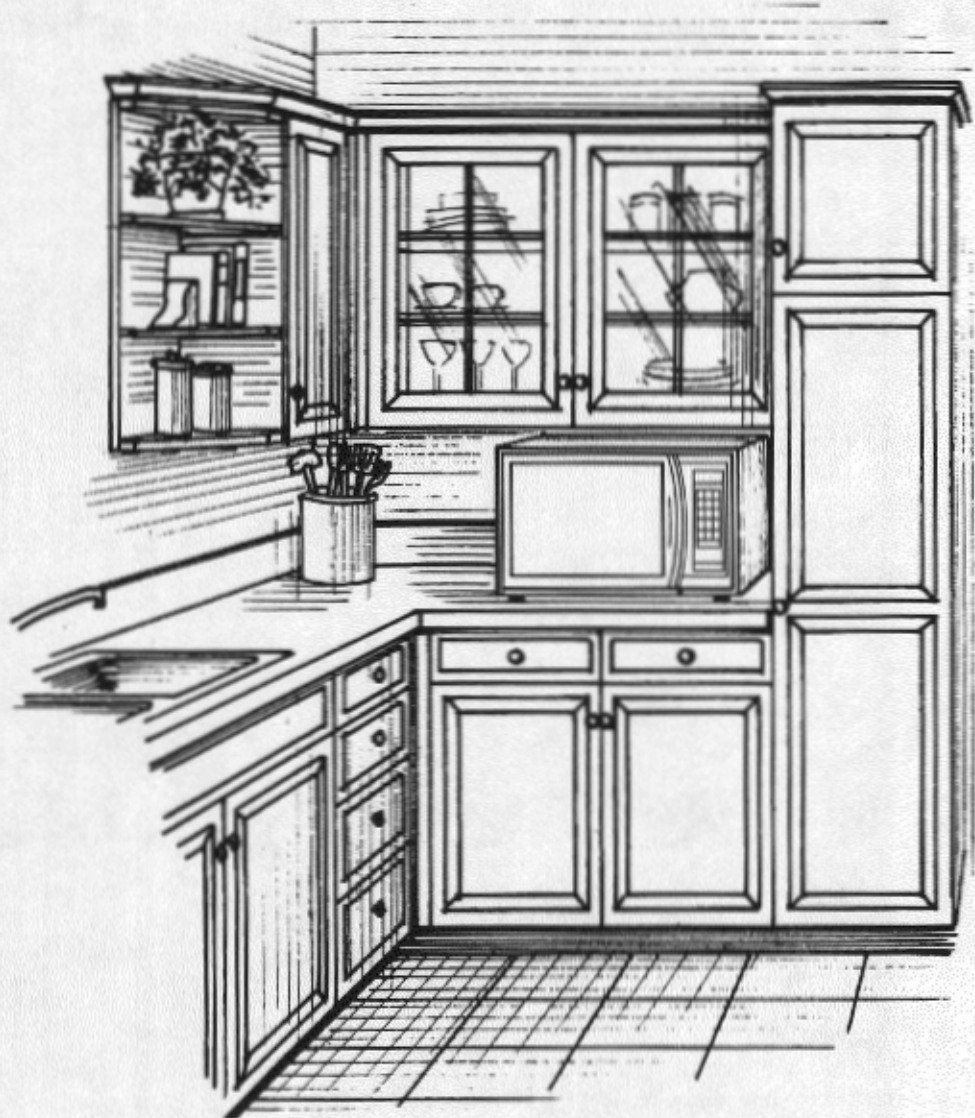

This manual contains Safety Instructions, Operating Instructions and Maintenance of the oven.
For Cooking Guide and Parts information, see page 13.
Before operating this oven, please read these instructions completely.

Thank you for purchasing the Panasonic Microwave Oven.
Please read the instructions completely.
Let's Start to Use Your Oven!—page 8.

PRECAUTIONS TO AVOID POSSIBLE EXPOSURE TO EXCESSIVE MICROWAVE ENERGY

- (a) Do not attempt to operate this oven with the door open since open-door operation can result in harmful exposure to microwave energy. It is important not to defeat or tamper with the safety interlocks.
- (b) Do not place any object between the oven front face and the door or allow soil or cleaner residue to accumulate on sealing surfaces.
- (c) Do not operate the oven if it is damaged. It is particularly important that the oven door close properly and that there is no damage to the:
 - (1) door (bent),
 - (2) hinges and latches (broken or loosened),
 - (3) door seals and sealing surfaces.
- (d) The oven should not be adjusted or repaired by anyone except properly qualified service personnel.

STAPLE YOUR STORE RECEIPT HERE.

The serial number of this product may be found on the right side of the oven door opening. You should note the model number and the serial number of this oven in the space provided and retain this book as a permanent record of your purchase for future reference.

Model No. _____

Serial No. _____

Date of Purchase _____

CONTENTS

Before Operating

Precautions	Inside Front Cover
Important Safety Instructions	2
Installation Instructions	3
Grounding Instructions	3
Safety Precautions	4
Cookware and Utensil Guide	5
Food Characteristics	6
Cooking Techniques	6
Feature Diagram	7
Control Panel	7

Operation

Let's Start to Use Your Oven!	8
To Set Clock	8
To Cook	
using Power & Time	9
using Convenience Pads	11
To Defrost	
using Power & Time	9
using Auto Defrost	10
To Reheat	
using Power & Time	9
using Auto Reheat	10
To use Popcorn Pad	8
Child Safety Lock	8
To use Quick Min Pad	10
To use Memory Pad	11
To use Timer (Stand time / Delay start)	9
Quick Guide to Operation	Back Cover

Maintenance

To order Accessories, Books, etc.	13
Care of Your Microwave Oven	13
Before Requesting Service	12
Technical Specifications	Bottom of this Page

Technical Specifications

	NN - L728 (1.7 cu. ft.)	NN - L628 (1.3 cu. ft.)
Power Consumption:	13.8 Amps, 1580 W	13.5 Amps, 1550 W
Output:*	1000 W	1000 W
Outside Dimensions	14" x 23 ⁷ / ₁₆ " x 16 ³ / ₄ "	12" x 21 ⁷ / ₈ " x 16 ³ / ₄ "
(H x W x D):	(356 x 595 x 425mm)	(306 x 555 x 425mm)
Oven Cavity Dimensions	10 ³ / ₁₆ " x 16 ⁵ / ₁₆ " x 15 ¹ / ₈ "	9 ¹ / ₈ " x 14 ¹⁵ / ₁₆ " x 15 ¹³ / ₁₆ "
(H x W x D):	(259 x 415 x 385mm)	(232 x 380 x 402mm)
Operating Frequency:	2,450 MHz	2,450 MHz
Uncrated Weight:	Approx. 40 lbs. (18 kg)	Approx. 38 lbs. (17.2 kg)

*IEC 705-88 Test procedure
Specifications subject to change without notice.

IMPORTANT SAFETY INSTRUCTIONS

Your microwave oven is a cooking device and you should use as much care as you use with a stove or any other cooking device. When using this electric appliance, basic safety precautions should be followed, including the following:

WARNING—To reduce the risk of burns, electric shock, fire, injury to persons, or exposure to excessive microwave energy:

1. Read all instructions before using the appliance.
2. Read and follow the specific **"PRECAUTIONS TO AVOID POSSIBLE EXPOSURE TO EXCESSIVE MICROWAVE ENERGY,"** found inside of the front cover.
3. This appliance must be grounded. Connect only to properly grounded outlet. See **"GROUNDING INSTRUCTIONS"** found on page 3.
4. Install or locate this appliance only in accordance with the installation instructions found on page 3.
5. Do not cover or block any openings on this appliance.
6. Do not store or use this appliance outdoors.
Do not use this product near water—for example, near a kitchen sink, in a wet basement, or near a swimming pool, and the like.
7. Use this appliance only for its intended use as described in this manual. Do not use corrosive chemicals or vapors in this appliance. This type of oven is specifically designed to heat, cook, or dry food. It is not designed for industrial or laboratory use.
8. When cleaning surfaces of door and oven that come together on closing the door, use only mild, non-abrasive soaps or detergents applied with a sponge or soft cloth.
9. Do not allow children to use this appliance, unless closely supervised by an adult.
10. Do not operate this appliance if it has a damaged cord or plug, if it is not working properly, or if it has been damaged or dropped.
11. Do not immerse cord or plug in water.
12. Keep cord away from heated surfaces.
13. Do not let cord hang over edge of table or counter.
14. This appliance should be serviced only by qualified service personnel. Contact the nearest authorized service facility for examination, repair or adjustment.
15. Some products such as whole eggs and sealed containers—for example, closed glass jars—may explode and should not be heated in this oven.
16. To reduce the risk of fire in the oven cavity:
 - (a) Do not overcook food. Carefully attend appliance if paper, plastic, or other combustible materials are placed inside the oven to facilitate cooking.
 - (b) Remove wire twist-ties from paper or plastic bags before placing bag in oven.
 - (c) If materials inside the oven should ignite, keep oven door closed, turn oven off, and disconnect the power cord, or shut off power at the fuse or circuit breaker panel.

(d) Do not use the cavity for storage purposes.

Do not leave paper products, cooking utensils, or food in the cavity when not in use.

General Use

1. **DO NOT** tamper with or make any adjustments or repairs to door, control panel housing, safety interlock switches or any other part of the oven. **Do NOT** remove outer panel from oven. Repairs should only be done by a qualified service person.

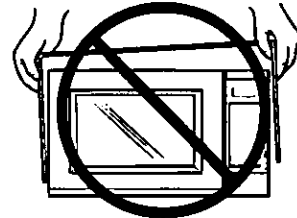

2. **DO NOT** operate the oven empty. The microwave energy will reflect continuously throughout the oven if food or water is not present to absorb energy. This could damage the oven and result in the danger of a fire.

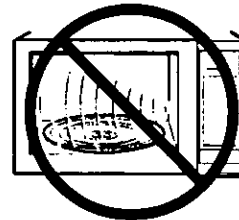

3. **DO NOT** use this oven to heat chemicals or any other non-food products. **Do NOT** clean this oven with any product that is labeled as containing corrosive chemicals. **The heating of corrosive chemicals in this oven can cause radiation leaks.**
4. **DO NOT** dry clothes, newspapers or other materials in oven. They may catch fire.
5. **DO NOT** use recycled paper products unless the paper product is labeled as safe for microwave oven use. Recycled paper products may contain impurities which may cause sparks and/or fires when used.
6. **DO NOT** use newspapers or paper bags for cooking. Fire can result.
7. **DO NOT** hit or strike control panel. Damage to controls may occur. Fire can result.
8. **POT HOLDERS** should always be used when removing items from the oven. Heat is transferred from the **HOT** food to the cooking container and from the cooking container to the Glass Tray. Glass Tray can be very **HOT** after removing cooking container from oven.
9. **DO NOT** store flammable materials next to, on top of, or in the oven. These could be fire hazards.

SAVE THESE INSTRUCTIONS

For proper use of your oven read remaining safety cautions and operating instructions.

INSTALLATION & GROUNDING INSTRUCTIONS

Examine Your Oven

Unpack oven, remove all packing material, and examine the oven for any damage such as dents, broken door latches or cracks in the door. Notify dealer immediately if oven is damaged. **DO NOT** install if oven is damaged.

Placement of Oven

- Oven must be placed on a flat, stable surface. For proper operation, the oven must have sufficient air flow. Allow 3 inches (8 cm) of space on both sides of the oven and 1 inch (2.5 cm) of space of space on top of oven.
 - DO NOT** block air vents. If they are blocked during operation, the oven may overheat. If the oven overheats, a thermal safety device will turn the oven off. The oven will remain inoperable until it has cooled.
 - DO NOT** place oven near a hot damp surface such as a gas or electric range.
 - DO NOT** operate oven when room humidity is too high.
- This oven was manufactured for household use only.

Grounding Instructions

This appliance must be grounded. In the event of an electrical short circuit, grounding reduces the risk of electric shock by providing an escape wire for the electric current. This appliance is equipped with a cord having a grounding wire with a grounding plug. The plug must be plugged into an outlet that is properly installed and grounded.

WARNING—Improper use of the grounding plug can result in a risk of electric shock.

Consult a qualified electrician or service person if the grounding instructions are not completely understood, or if doubt exists as to whether the appliance is properly grounded. If it is necessary to use an extension cord, use only a three wire extension cord that has a three blade grounding plug, and a three slot receptacle that will accept the plug on the appliance. The marked rating of the extension cord should be equal to or greater than the electrical rating of the appliance.

Power Supply

- A short power-supply cord is provided to reduce the risks resulting from becoming entangled in or tripping over a longer cord.
- Longer cord sets or extension cords are available and may be used if care is exercised in their use.
- If a long cord or extension cord is used, (1) the marked electrical rating of the cord set or extension cord should be at least as great as the electrical rating of the appliance, (2) the extension cord must be a grounding-type 3-wire cord, and (3) the longer cord should be arranged so that it will not drape over the counter top or tabletop where it can be pulled on by children or tripped over accidentally.

Wiring Requirements

- The oven must be on a **SEPARATE CIRCUIT**. No other appliance should share the circuit with the microwave oven. If it does, the branch circuit fuse may blow, the circuit breaker may trip, or the food may cook slower than the times recommended in this manual.
- The **VOLTAGE** used must be the same as specified on this microwave oven (120 V). Using a higher voltage is dangerous and may result in a fire or other accident causing oven damage. Using a lower voltage will cause slow cooking. Panasonic is **NOT** responsible for damage resulting from the use of the oven with other than specified voltage.
- The oven must be plugged into at least a **20 AMP, 120 VOLT, 60 Hz GROUNDED OUTLET**. Where a standard two-prong outlet is encountered, it is the personal responsibility and obligation of the consumer to have it replaced with a properly grounded three-prong outlet.

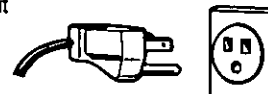

- A **TEMPORARY CONNECTION** with a two-prong adapter may be made where **LOCAL CODES PERMIT**. Unless the cover screw is grounded through the house wiring, attaching the adapter grounding plate to the cover screw will not ground the oven. If there is any doubt that the cover screw is grounded, have it checked by an electrician.



Radio Interference

- Operation of the microwave oven may cause interference to your radio, TV or similar equipment.
- When there is interference, it may be reduced or eliminated by taking the following measures:
 - Clean door and sealing surfaces of the oven. (See Care of Your Microwave Oven found on page 13.)
 - Place the radio, TV, etc. away from the microwave oven as far as possible.
 - Use a properly installed antenna to obtain stronger signal reception.

Safety Precautions

Follow These Safety Precautions When Cooking in Your Oven

1) HOME CANNING / DRYING FOODS / SMALL QUANTITIES OF FOODS

- **Do not** use your oven for home canning or the heating of any closed jar. Pressure will build up and the jar may explode. Your oven cannot maintain the food at the proper canning temperature. Improperly canned food may spoil and be dangerous to consume.
- Small quantities of food or foods with low moisture content can dry out, burn or catch on fire.
- **Do not** dry meats, herbs, fruits or vegetables in your oven.

IMPORTANT

Proper cooking depends on time set and quantity of food. If you use a smaller portion than recommended and cook at the time for the recommended portion, fire can result.

If a fire occurs, turn oven off and leave oven door closed. Disconnect the power cord or shut off power at the fuse or circuit breaker panel.

2) POPCORN

Popcorn must be popped in a microwave oven corn popper. Microwave popcorn which pops in its own package is also available. Follow popcorn manufacturers' directions and use a brand suitable for the wattage of your microwave oven. Never leave oven unattended when popping popcorn. Allow the popcorn bag to cool before opening it. To prevent steam burns, always open the bag away from your face and body.

CAUTION:

When using pre-packaged microwave popcorn, follow recommended package instructions. Check package weight before using the Popcorn pad. Set the oven for the weight of the popcorn package. (see page 8) If these instructions are not followed, the popcorn may not pop adequately or may ignite and cause a fire.

3) DEEP FAT FRYING

- **Do not** attempt to deep fat fry in your microwave oven. Cooking oils may burst into flames and may cause damage to the oven and perhaps result in burns. Microwave utensils may not be able to withstand the temperature of the hot oil, and could shatter.

4) EGGS

- **Do not** heat eggs in their shell in a microwave oven. Pressure will build up and the eggs will explode.

5) FOODS WITH NONPOROUS SKINS

- **Potatoes, apples, egg yolks, whole squash and sausages are examples of foods with nonporous skins.** These types of foods must be pierced before microwave cooking to prevent their bursting.
- Use fresh potatoes for baking and cook until just done. Overcooking causes dehydration and may cause a fire. Use recommended weights or fire may occur.

6) LIQUIDS

- Heated liquids can erupt if not mixed with air. **Do not** heat liquids in your microwave oven without first stirring.

7) GLASS TRAY / COOKING UTENSILS / FOIL

- Cooking utensils get hot during microwaving. Use potholders when removing utensils from the oven or when removing lids or plastic wrap covers from cooking utensils to avoid burns.
- The glass tray will get hot during cooking. It should be allowed to cool before handling or before paper products, such as paper plates or microwave popcorn bags, are placed in the oven for microwave cooking.
- When using foil, skewers, warming rack or utensils made of metal in the oven, allow at least 1-inch (2.5 cm) of space between metal material and interior oven walls. If arcing occurs (sparking), remove metal material (skewers etc.) and/or transfer to a non-metallic container.
- Dishes with metallic trim should **not** be used, as arcing may occur.

8) PAPER TOWELS / CLOTHS

- **Do not** use paper towels or cloths which contain a synthetic fiber woven into them. The synthetic fiber may cause the towel to ignite.
- **Do not** use paper bags or recycled paper products in the microwave oven.

9) BROWNING DISHES / OVEN COOKING BAGS

- Browning dishes or grills are designed for microwave cooking only. Always follow instructions provided by the manufacturer. Do not preheat browning dish more than 6 minutes.
- If an oven cooking bag is used for microwave cooking, prepare according to package directions. Do not use a wire twist-tie to close bag.

10) THERMOMETERS

- **Do not** use a conventional meat thermometer in your oven. Arcing may occur. Microwave-safe thermometers are available for both meat and candy.

11) BABY FORMULA / FOOD

- **Do not** heat baby formula or food in the microwave oven. The glass jar or surface of the food may appear warm while the interior can burn the infant's mouth and esophagus.

12) REHEATING PASTRY PRODUCTS

- When reheating pastry products, check temperatures of any fillings before eating. Some foods have fillings which heat faster and can be extremely hot while the surface remains warm to the touch (ex. Jelly Donuts).

13) GENERAL OVEN USAGE GUIDELINES

- **Do not** use the oven for any reason other than the preparation of food.
- **Do not** leave oven unattended while in use.

Cookware and Utensil Guide

ITEM	MICROWAVE	COMMENTS
Aluminum Foil	Yes for Shielding only	Small strips of foil can be molded around thin parts of meat or poultry to prevent overcooking. Arcing can occur if foil is too close to oven wall or if too much foil is used.
Browning Dish	Yes	Browning dishes are designed for microwave cooking only. Check browning dish information for instructions and heating chart. Do not preheat for more than 6 minutes.
Brown paper bags	No	May cause a fire in the oven.
Dinnerware Labelled "Microwave-Safe"	Yes	Check manufacturers' use and care directions for use in microwave heating. Some dinnerware may state on the back of the dish, "Oven-Microwave Safe".
Other Dinnerware	?	Use CONTAINER TEST below.
Disposable polyester Paperboard Dishes	Yes	Some frozen foods are packaged in these dishes. Can be purchased in grocery stores.
Fast Food Carton with Metal Handle	No	Metal handle may cause arcing.
Frozen Dinner Tray Metal	Yes	Frozen dinners may be heated in foil tray, if tray is less than 3/4 inch (2 cm) high. Place foil tray in center of oven. Leave at least 1 inch (2.5 cm) space between foil tray and oven walls. Heat only 1 foil tray in the oven at a time. For containers more than 3/4 inch (2 cm) deep, remove food and place in a similar size microwave-safe container.
Microwave-safe	Yes	
Glass Jars	Yes, use caution	Remove lid. Heat food until just warm, not HOT. Most glass jars are not heat resistant. Do not use for cooking.
Glassware Heat Resistant Oven Glassware & Ceramics	Yes	Ideal for microwave cooking and browning. (See CONTAINER TEST below)
Metal Bakeware	No	Not recommended for use in microwave ovens.
Metal Twist Ties	No	May cause arcing which could cause a fire in the oven.
Oven Cooking Bag	Yes	Follow manufacturers' directions. Close bag with the nylon tie provided, a strip cut from the end of the bag, or a piece of cotton string. Do not close with metal twist tie. Make six 1/2 inch (1 cm) slits near the closure.
Paper Plates & Cups	Yes	Use to warm cooked foods, and to cook foods that require short cooking times such as hot dogs.
Paper Towels & Napkins	Yes	Use to warm rolls and sandwiches by microwave.
Parchment Paper	Yes	Use as a cover to prevent spattering. Safe for use in microwave, microwave/convection and conventional ovens.
Plastic Microwave-Safe Cookware	Yes	Should be labeled, "Suitable for Microwave Heating." Check manufacturers' directions for recommended uses. Some microwave-safe plastic dishes are not suitable for cooking foods with high fat or sugar content. The heat from hot food may cause the plastic to warp.
Reheat & Storage	Yes, use caution	
Melamine	No	This material absorbs microwave energy. Dishes get HOT!
Plastic Foam Cups	Yes	Plastic foam will melt if foods reach a high temperature. Use to bring foods to a low serving temperature.
Plastic Wrap	Yes	Use to cover food during cooking to retain moisture and prevent spattering. Should be labelled "Suitable for Microwave Heating". Check package directions.
Straw, Wicker, Wood	Yes	Use only for short term reheating and to bring food to a low serving temperature.
Thermometers Microwave-safe, only Conventional	Yes No	Use only microwave-safe meat and candy thermometers. Not suitable for use in microwave oven, will cause sparks and get hot.
Wax paper	Yes	Use as a cover to prevent spattering and to retain moisture.

CONTAINER TEST 1-CUP

TO TEST A CONTAINER FOR SAFE MICROWAVE OVEN USE: Fill a 1-cup glass measure with water and place it in the microwave oven along with the container to be tested; **heat one (1) minute at HIGH**. If the container is microwave oven-safe, the container should remain comfortably cool and the water should be hot. If the container is hot, it has absorbed some microwave energy and should **NOT** be used. This test cannot be used for plastic containers.

Food Characteristics

Bone and Fat: Both bone and fat affect cooking. Bones may cause irregular cooking. Meat next to the tips of bones may overcook while meat positioned under a large bone, such as a ham bone, may be undercooked. Large amounts of fat absorb microwave energy and the meat next to these areas may overcook.

Density: Porous, airy foods such as breads, cakes or rolls take less time to cook than heavy, dense foods such as potatoes and roasts.

Quantity: Two potatoes take longer to cook than one potato. As the quantity of the food increases so does the cooking time.

When cooking small amounts of food such as one or two potatoes, do not leave oven unattended. The moisture content in the food may decrease and a fire could result.

Shape: Uniform sizes heat more evenly. The thin end of a drumstick will cook more quickly than the meaty end. To compensate for irregular shapes, place thin parts toward the center of the dish and thick pieces toward the edge.

Size: Thin pieces cook more quickly than thick pieces.

Starting Temperature: Foods that are room temperature take less time to cook than if they are refrigerator temperature or frozen.

Cooking Techniques

Spacing: Individual foods, such as baked potatoes, cupcakes and appetizers, will cook more evenly if placed in the oven equal distances apart. When possible, arrange foods in a circular pattern.

Browning: Foods will not have the same brown appearance as conventionally cooked foods. Meats and poultry may be coated with browning sauce, Worcestershire sauce, barbecue sauce or shake-on browning sauce. To use, combine browning sauce with melted butter or margarine; brush on before cooking.

Piercing: Foods with skins or membranes must be pierced, scored or have a strip of skin peeled before cooking to allow steam to escape. Pierce whole egg yolks and whites, clams, oysters, chicken livers, whole potatoes and whole vegetables. Whole apples or new potatoes should have a 1-inch strip of skin peeled before cooking. Score sausage, frankfurters and hot dogs.

Covering: As with conventional cooking, moisture evaporates during microwave cooking. Casserole lids or plastic wrap are used for a tighter seal. When using plastic wrap, vent the plastic wrap by folding back part of the plastic wrap from the edge of the dish to allow steam to escape. Loosen or remove plastic wrap as recipe directs for stand time. When removing plastic wrap covers, as well as any glass lids, be careful to remove them away from you to avoid steam burns. Various degrees of moisture retention are also obtained by using wax paper or paper towels. However, unless specified, a recipe is cooked uncovered.

Shielding: Thin areas of meat and poultry cook more quickly than meaty portions. To prevent overcooking, these thin areas can be shielded with strips of aluminum foil. Wooden toothpicks may be used to hold the foil in place.

Timing: A range in cooking time is given in each recipe. The time range compensates for the uncontrollable differences in food shapes, starting temperature and regional preferences. Always cook food for the minimum cooking time given in a recipe and check for doneness. If the food is undercooked, continue cooking. It is easier to add time to an undercooked product. Once the food is overcooked, nothing can be done.

Stirring: Stirring is usually necessary during microwave cooking. We have noted when stirring is helpful, using the words once, twice, frequently or occasionally to describe the amount of stirring necessary.

Rearranging: Rearrange small items such as chicken pieces, shrimp, hamburger patties or pork chops. Rearrange pieces from the edge to the center and pieces from the center to the edge of the dish.

Turning: It is not possible to stir some foods to redistribute the heat. At times microwave energy will concentrate in one area of a food. To help insure even cooking, these foods need to be turned. Turn over large foods, such as roasts or turkeys, halfway through cooking.

Standing Time: Most foods will continue to cook by conduction after the microwave oven is turned off. In meat cookery, the internal temperature will rise 5°F to 15°F if allowed to stand, tented with foil, for 10 to 15 minutes. Casseroles and vegetables need a shorter amount of standing time, but this standing time is necessary to allow foods to complete cooking in the center without overcooking on the edges.

Testing for Doneness: The same tests for doneness used in conventional cooking may be used for microwave cooking. Meat is done when fork-tender or splits at fibers. Chicken is done when juices are clear yellow and drumstick moves freely. Fish is done when it flakes and is opaque.

Feature Diagram

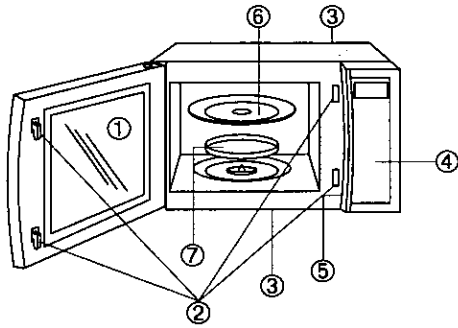

- ① See-through Oven Window with vapor barrier film (Do Not Remove)
- ② Door Safety Lock System
- ③ External Air Vents
- ④ Control Panel
- ⑤ Identification Plate
- ⑥ Glass Tray
- ⑦ Roller Ring

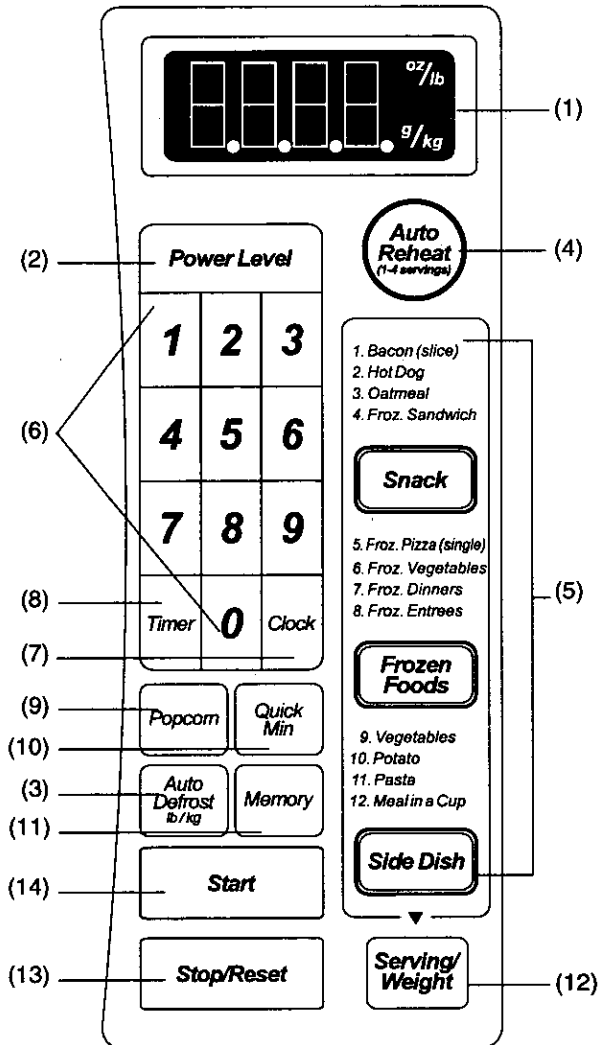

Control Panel

NN-L728 / NN-L628



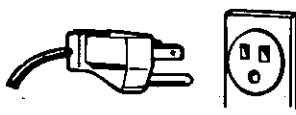

- (1) **Display Window**
The oven displays weight in oz/lb or in g/kg. Press **Start Pad** immediately to select the system you desire. An indicator appears when selecting the system. (☛page 8)
- (2) **Power Level Pad** (☛page 9)
- (3) **Auto Defrost Pad** (☛page 10)
- (4) **Auto Reheat Pad** (☛page 10)
- (5) **Convenience Pads** (☛page 11)
- (6) **Number Pads**
- (7) **Clock Pad** (☛page 8)
- (8) **Timer Pad** (☛page 9)
- (9) **Popcorn Pad** (☛page 8)
- (10) **Quick Minute Pad** (☛page 10)
- (11) **Memory Pad**
- (12) **Serving/Weight Pad** (☛page 11)
- (13) **Stop/Reset Pad**
Before cooking: One tap clears your instruction.
During cooking: One tap temporarily stops the cooking process. Another tap cancels all your instructions and time of day or dot appears on the screen.
- (14) **Start Pad**
One tap allows oven to begin functioning. If door is opened or **Stop/Reset Pad** is pressed once during oven operation, **Start Pad** must again be pressed to restart oven.

Let's Start to Use Your Oven!

- | | |
|---|---|
| <p>1.</p>  | <ul style="list-style-type: none"> • Plug in a properly grounded electrical outlet. • lb/kg Conversion: The oven automatically displays the oz/lbs symbol when using Auto Defrost feature etc. • <u>If you wish to use the kg/g, press Start Pad immediately after the oven is plugged in. An indicator will move to the selected weight system.</u> |
| <p>2.</p>  | <ul style="list-style-type: none"> • Press Stop/Reset Pad to delete "88.88" indication. Now, you may set the clock (see below). |

To Set Clock

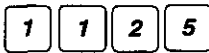
You can use the oven without setting the clock.

- | | |
|--|--|
| <p>Example: To set 11:25</p> | |
| <p>1.</p>  | <ul style="list-style-type: none"> • Press. ▶ Dot will blink. |
| <p>2.</p>  | <ul style="list-style-type: none"> • Enter time of day using the number pads. ▶ Time appears on the screen; dot is blinking. |
| <p>3.</p>  | <ul style="list-style-type: none"> • Press. ▶ Dot stops blinking; time of day is entered and locked onto the screen. |

NOTES:

1. To reset time of day, repeat step 1 through step 3.
2. The clock will keep the time of day as long as oven is plugged in and electricity is supplied.
3. Clock is a 12-hour display.

Child Safety Lock

This feature prevents the electronic operation of the oven until cancelled. It does **not** lock the door.

To Set:



- | | |
|--|--|
| <p>1.</p>  <p>3 times</p> | <ul style="list-style-type: none"> • Press 3 times. ▶ "CHILD" appears on the screen. |
|--|--|

To Cancel:

- | | |
|--|---|
| <p>1.</p>  <p>3 times</p> | <ul style="list-style-type: none"> • Press 3 times. ▶ Time of day or dot appears on the screen. |
|--|---|

To Use Popcorn Pad

Example: To heat 3.5 oz. of prepackaged microwave popcorn

- | | |
|--|--|
| <p>1.</p>  <p>Press once</p> | <ul style="list-style-type: none"> • Set the desired weight of prepackaged microwave popcorn. (3.5 oz., 3.0 oz., or 1.75 oz.) |
| <p>2.</p>  | <ul style="list-style-type: none"> • Press Start Pad. ▶ Cooking time appears in the display and begins to count down. |

NOTES ON POPCORN PAD:

1. Use prepackaged room temperature microwave popcorn. Read manufacturers' instructions.
2. Place bag in oven according to manufacturers' directions.
3. Pop only one bag at a time.
4. After popping, open bag carefully, popcorn and steam are extremely hot.
5. Do not reheat unpopped kernels or reuse bag.
6. The recommended weights are already programmed in the memory.
7. **Never** leave oven unattended when popping popcorn.

Press Pad	Weight
once	3.5 oz. (99g)
twice	3.0 oz. (90g)
3 times	1.75 oz. (50g)



CAUTION:

If pre-packaged popcorn is of a different weight than those on the chart, do not use the popcorn setting, or inadequate popping or a fire may occur. Follow the manufacturers' instructions.

Power & Time Setting

How do I program Power and Time?

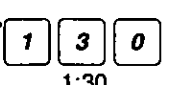
Example: To cook at MEDIUM Power for 1 minute 30 seconds

1.  Med = 4 times	• Select Power Level . (according to the chart below)
2.  1:30	• Set Cooking Time using number pads. (up to 99 minutes and 99 seconds for a single stage)
3. 	• Press. ▶Cooking will start. The time on the screen will count down. To recall the selected power level, press Power Level Pad at any time.

Press	Power Level	% Power
once	P100 (HIGH)	100%
twice	dEF (DEFROST)	30%
3 times	P 70 (MEDIUM-HIGH)	70%
4 times	P 50 (MEDIUM)	50%
5 times	P 30 (MEDIUM-LOW)	30%
6 times	P 10 (LOW)	10%

NOTES:



- For 2 or 3 stage cooking, repeat steps 1 and 2 above before pressing **Start** Pad.
- When selecting HIGH Power on the first stage, you can start from step 2.
- Two beeps will sound between each stage of programming. Five beeps will sound at the end of the sequence.
- For reheating, use Medium High (P70).

To Set Timer

This feature allows you to program a Standing Time after cooking is completed and to program the oven as a minute timer and/or to program a delay start.

To Use as a Kitchen Timer:

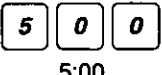



Example: To count 5 minutes

1. 	• Press Timer Pad.
2.  5:00	• Set desired amount of time using number pads. (up to 99 minutes and 99 seconds)
3. 	• Press Start Pad. ▶Time will count down without oven operating.

To Set Timer (cont.)

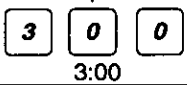

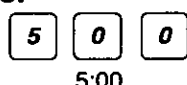

To Set Standing Time:

Example: To stand for 5 minutes after cooking (3 mins. at MEDIUM Power)

1.  Med = 4 times ↓  3:00	• Set the desired cooking program (power level and time).
2. 	• Press Timer Pad.
3.  5:00	• Set desired amount of Stand Time using number pads. (up to 99 minutes and 99 seconds)
4. 	• Press Start Pad. ▶Cooking will start. After cooking, standing time will count down without oven operating.

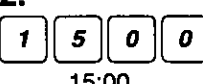
To Set Delay Start:

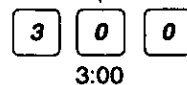
Example: To delay the start of cooking for 15 mins. (3 mins. at MEDIUM Power)



1. 	• Press Timer Pad.
2.  15:00	• Set desired amount of delayed time using number pads. (up to 99 minutes and 99 seconds)
3.  Med = 4 times ↓  3:00	• Set the desired cooking program (power level and time).
4. 	• Press Start Pad. ▶Delayed time will count down. Then cooking will start.

NOTES:

- If oven door is opened during the Standing Time or Kitchen Timer, the time in Display Window will continue to count down.
- Delay Start cannot be programmed before any Auto Control Function. This is to prevent the starting temperature of the food from rising before defrosting or cooking begins. A change in the starting temperature could cause inaccurate results.
- At the end of the entire sequence, you will hear 5 beeps.

To Use Auto Reheat Pad

This feature allows you to reheat 1 to 4 servings of precooked room temperature and refrigerator temperature foods without setting power and time.

Example: To reheat 2 cups of soup	
1.  2 times	• Press until the desired number of servings appears on the screen.
2. 	• Press ▶Cooking time appears on the screen and begins to count down.

NOTE:

1. **Auto Reheat** can be programmed for 1 to 4 servings (each serving is 4 oz.).
2. The following are the recommended food items and approximate weights.

Foods	Number of Servings	Serving Size	Starting Temp.
Plate of Food	3 - 4	12 - 16 oz.	Refrig.
Meat, Poultry	1 - 4	4 oz. ea.	Refrig.
Casseroles	1 - 4	4 - 16 oz.	Refrig.
Side Dishes	1 - 4	4 oz. ea.	Refrig. or Room
Soups, Sauces, Gravy	1 - 2	4 - 6 oz. ea.	Refrig. or Room



For best results follow these recommendations:

1. All foods must be previously cooked.
2. Foods should always be covered loosely with plastic wrap, wax paper or casserole lid.
3. All foods should have a covered stand time of 3 to 5 minutes.
4. **DO NOT** reheat bread and pastry products. Use manual power and time.
5. **DO NOT** reheat beverages.

Quick Min Function

This feature helps you in programming your oven without pressing Number Pads and allows you to add extra cooking time easily.

To Set Cooking Time:

1. 	• Set cooking time (up to 10 taps/minutes)
2. 	• Press ▶Cooking will start on HIGH power.

NOTE:

1. You can use other power levels, select the desired power level before setting the cooking time.
2. After setting the time by **Quick Min** Pad, you cannot use Number Pads, and vice versa.

Quick Min Function (cont.)

To Add Extra Cooking Time:



	• Press to add extra cooking time (up to 10 taps) during cooking. ▶Cooking time changes to include extra time and continues to count down in the display window.
---	---

NOTE: You can add cooking time during the program with power and time settings.

To Use Auto Defrost Pad

This feature allows you to defrost meat, poultry and seafood by weight without setting time.

Example: To defrost 1.5 pounds of meat

1. 	• Set the weight of the food. Weight must be programmed in pounds and tenths of a pound (not ounces) (see chart below). If you wish to use the kg/g., see page 8 (Let's Start to Use Your Oven!).
2. 	• Press. ▶Defrosting time appears on the screen and begins to count down.

NOTE:

1. For best results, the minimum recommended weight is 0.5 pounds.
2. The shape and size of the food will determine the maximum weight the oven can accommodate. The recommended **maximum weight of meat is 4 lb.; poultry, 6 lb. and seafood, 3 lb.**
3. Stand time or power level may be programmed after Auto Defrost (see Stand Time on page 9).
4. The oven beeps once during the defrosting cycle to signal that the food needs to be turned or rearranged. To prevent overdefrosting, thin areas or edges can be shielded with strips of aluminum foil.

Conversion Chart:

Follow this chart to convert ounces or hundredths of a pound into tenths of a pound. To use Auto Defrost, program the weight of the food in pounds (1.0) and tenths of a pound (0.1). If a piece of meat weighs 1.95 pounds or 1 pound 14 ounces, program 1.9 pounds. If a piece of meat weighs 1.99 pounds or 2 pounds 0 ounces, program 2.0 pounds.

Ounces	Hundredths of a Pound	Tenths of a Pound
0	.96 - .05	0.0
1 - 2	.06 - .15	0.1
3 - 4	.16 - .25	0.2
5	.26 - .35	0.3
6 - 7	.36 - .45	0.4
8	.46 - .55	0.5
9 - 10	.56 - .65	0.6
11 - 12	.66 - .75	0.7
13	.76 - .85	0.8
14 - 15	.86 - .95	0.9

Auto Cooking

This feature allows you to cook most of your favorite foods without setting power and time.

1 Press Convenience Pad

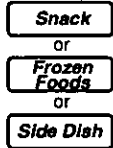

2 Select *Servicing/Weight*



3 Press *Start*



Press desired category until recipe is displayed.

Category		SERVING - WEIGHT	Category		SERVING - WEIGHT
Snack	1. Bacon (slice) Use ridged dish, cover with paper towel	2, 3, 4, or 6 slices	Side Dish	9. Vegetables Add water and cover with plastic wrap or lid.	4, 8, 12 or 16 oz. (110, 225, 340 or 450g)
	2. Hot Dog Pierce skin.	1 - 4 pieces		10. Potato (6 - 8 oz. each) Pierce skin with fork.	1 - 4 pieces
	3. Oatmeal	1 - 2 servings		11. Pasta Cover with lid or plastic wrap.	2 oz (60 g) 2 cups of water 4 oz. (110 g) 3 cups of water 6 oz. (170 g) 4 cups of water 8 oz. (225 g) 5 cups of water
	4. Froz. Sandwich	1 - 2 pieces			12. Meal in a Cup Remove metal lid and film.
Frozen Foods	5. Froz. Pizza (single) Follow directions on box.	4 or 8 oz. (110 or 225 g)			
	6. Froz. Vegetables	5, 10 or 16 oz. (150, 300 or 450 g)			
	7. Froz. Dinners	11 or 15 oz. (300 or 430 g)			
	8. Froz. Entrees	8, 10, 20 or 32 oz. (225, 300, 600 or 900g)			

To use Memory Pad

This feature allows you to store one recipe of your own and use it at any time with only one touch.

To Program Memory:

Example: To make packaged hot chocolate.

Your program: **Med.-High** 1:45

1 Press *Memory* once



2 Input recipe

Press *Power Level* **Med.-High**
Enter Time (using number pads) **1:45**

3 Press *Memory* once



Recipe program is set in **Memory**.

> Time of day or dot appears in Display Window.

To Use Memory Program:

1 Press *Memory*



2 Press *Start*



Stage 1 of the recipe program will appear in the Display Window.

Display Window counts down.

- Notes:**
1. Auto Control Functions cannot be programmed into **Memory** pad. (i.e. Auto Reheat, Auto Defrost, etc.)
 2. A new recipe program will cancel the old recipe program.
 3. The memory program will be canceled if the oven is unplugged.

Before Requesting Service

All these things are normal:

The oven causes interference with my TV.

Some radio and TV interference might occur when you cook with the microwave oven. This interference is similar to the interference caused by small appliances such as mixers, vacuums, blow dryers, etc. It does not indicate a problem with your oven.

The oven lights dim.

When cooking with a power other than HIGH, the oven must cycle to obtain the lower power levels. The oven light will dim and clicking noises can be heard when the oven cycles.

Steam accumulates on the oven door and warm air comes from the oven vents.

During cooking, steam and warm air are given off from the food. Most of the steam and warm air are removed from the oven by the air which circulates in the oven cavity. However, some steam will condense on cooler surfaces such as the oven door. This is normal.

I accidentally ran my microwave oven without any food in it.

Running the oven empty for a short time will not damage the oven. However, we do not recommend operating the microwave oven without any food in it.

PROBLEM

POSSIBLE CAUSE

REMEDY

Oven will not turn on.



The oven is not plugged in securely.

Remove plug from outlet, wait 10 seconds and reinsert.

Circuit breaker or fuse is tripped or blown.

Reset circuit breaker or replace fuse.

There is a problem with the outlet.

Plug another appliance into the outlet to check if it is working.

Oven will not start cooking.



The door is not closed completely.

Close the oven door securely.

Start Pad was not pressed after programming.

Press **Start Pad**.

Another program entered already in the oven.

Press **Stop/Reset Pad** to cancel the previous program and program again.

The program is not correct.

Program again according to the Operating Instructions.

Stop/Reset Pad has been pressed accidentally.

Program oven again.

When the oven is turning on, there is noise coming from the glass tray.



The roller ring and oven bottom are dirty.

Clean these parts according to **Care of Your Microwave Oven** (next page).

If it seems there is a problem with the oven, contact an authorized Servicenter.

If you have any questions or it seems there is a problem with the oven, contact PANASONIC CUSTOMER CALL CENTER for assistance.
1-800-211-PANA(7262) (9 a.m. - 9 p.m., E.S.T., toll free).

Care of Your Microwave Oven

BEFORE CLEANING:

Unplug at socket of the oven. If impossible, leave oven door open to prevent oven from accidentally turning on.

AFTER CLEANING:

Be sure to replace the Roller Ring and Glass Tray in the proper position and press **Stop/Reset** Pad to clear the screen.

Inside of the oven:

Wipe with a damp cloth. Mild detergent may be used if the oven gets very dirty. The use of harsh detergent or abrasives is not recommended.

Glass Tray:

Remove and wash in warm soapy water or in a dishwasher.

Outside oven surfaces.

Clean with a damp cloth. To prevent damage to the operating parts inside the oven, water should not be allowed to seep into ventilation openings.

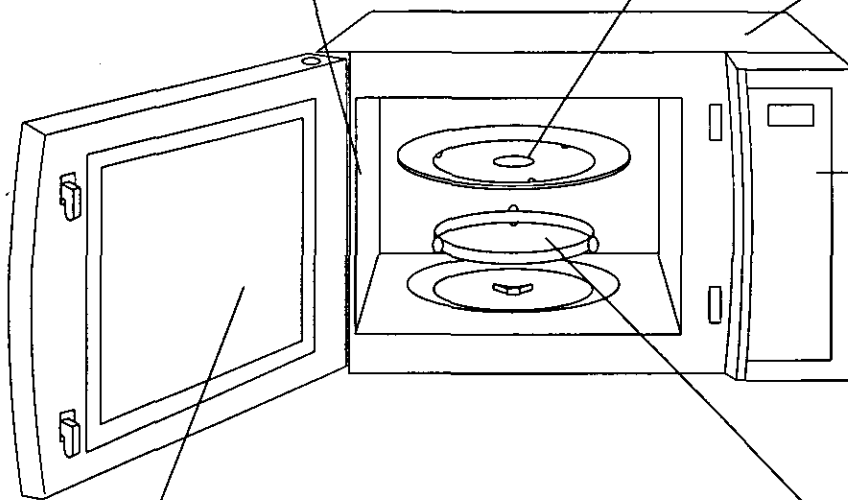

Control Panel:

* Covered with a removable protective film to prevent scratches during shipping. Small bubbles may appear under this film.

(Hint - To remove film, apply masking or clear tape to an exposed corner and pull gently.)

* If the control panel becomes wet, clean it with a soft dry cloth. Do not use harsh detergents or abrasives on the Control Panel.

Oven Door:

Wipe with a soft cloth when steam accumulates inside or around the outside of the oven door. During cooking, especially under high humidity conditions, steam is given off from the food. (Some steam will condense on cooler surfaces, such as the oven door.) This is normal.

Roller Ring and oven cavity floor:

Wipe the bottom surface of the oven with mild detergent water or window cleaner and dry. Roller Ring may be washed in mild soapy water or dishwasher. These areas should be kept clean to avoid excessive noise.

ORDER FORM

For more information regarding microwave cooking, order our new **COOKING GUIDE** (68 pages of recipes & charts).

DESCRIPTION

PART NUMBER

PRICE

Instruction / Operating Manual (this book)

B00034B7BAP

①

COOKING GUIDE

B000B8250AP

\$9.49

Glass Tray (see **Care of Your Microwave Oven** above)

A06014000AP (NN-L628)

\$24.31

A06014A00AP (NN-L728)

①

Roller Ring Assembly

B290D9330AP (NN-L628)

\$10.99

B290D5500AP (NN-L728)

\$13.16

① For pricing quotes, call or write the Parts & Literature Department at the phone or address listed below. Please have your credit card information readily available.

Shipping & handling are not included. Price & availability subject to change. Sorry, no COD's.

PANASONIC SERVICES COMPANY







20421 84th Avenue South

Kent, WA 98032

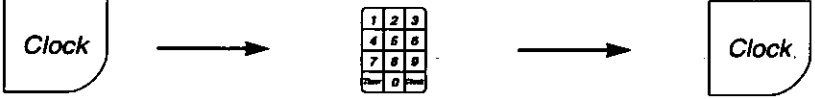
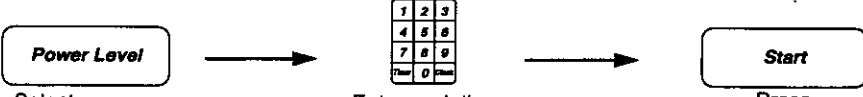
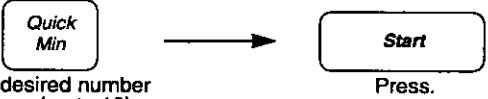
(800) 833-9626 - Phone

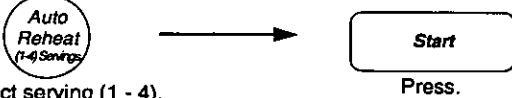
(800) 237-9080 - FAX

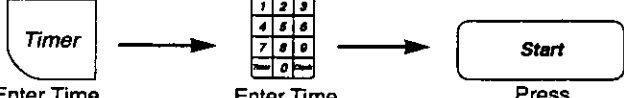
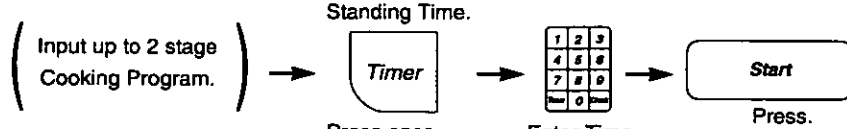
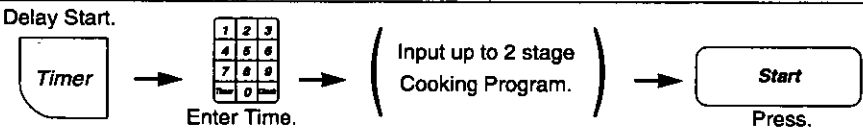
Quick Guide to Operation

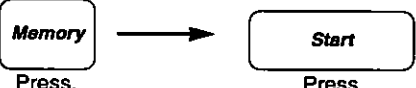
Feature	How to Operate
To Set Clock (☛ page 8)	 <p>Press once. Enter time of day. Press.</p>
Power and Time Setting (☛ page 9)	 <p>Select power. Enter cook time. Press.</p>
To Cook using Quick Min (☛ page 10)	 <p>Tap desired number of times (up to 10). Press.</p>
To Defrost using Manual Defrost (☛ page 9)	 <p>Select defrost (2 x's). Enter cook time. Press.</p>
To Defrost using Auto Defrost (☛ page 10)	 <p>Press. Enter weight. Press.</p>
To Reheat using Auto Reheat (☛ page 10)	 <p>Select serving (1 - 4). Press.</p>
To Cook using Popcorn (☛ page 8)	 <p>Select weight. Press.</p>
To Use as a Timer (☛ page 9)	 <p>Enter Time. Enter Time. Press.</p>
To Set Standing Time (☛ page 9)	 <p>Standing Time. (Input up to 2 stage Cooking Program.) Press once. Enter Time. Press.</p>
To Set Delay Start (☛ page 9)	 <p>Delay Start. Enter Time. (Input up to 2 stage Cooking Program.) Press.</p>
To Cook using Convenience Pads (☛ page 11)	 <p>Press for Desired Category. Press.</p>
To Use Memory Program (☛ page 11)	 <p>Press. Press.</p>