

Panasonic®

the Genius

Cookbook and Operating Instructions

Microwave Oven
Model NN-T687 / NN-R687

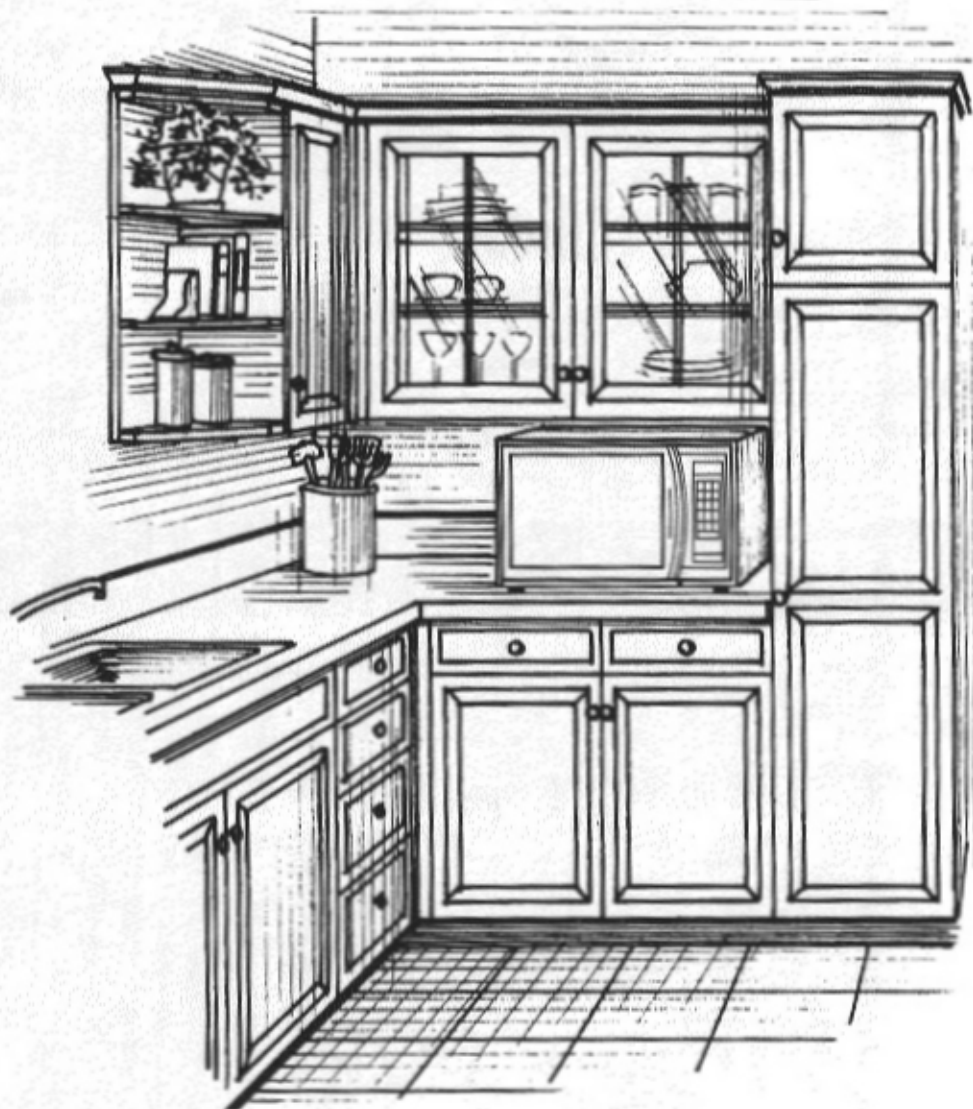

Before operating this oven, please read these instructions completely.
Antes de operar este producto, lea este instructivo en su totalidad.
El manual de instrucciones en español puede ser encontrada en la páginas 42-53.
Spanish Operating Instructions can be found on pages 42-53.
To order Parts & Accessories, see page 41

Thank you for purchasing a Panasonic Microwave Oven.
 Let's Start to Use Your Oven! -- page 8

PRECAUTIONS TO AVOID POSSIBLE EXPOSURE TO EXCESSIVE MICROWAVE ENERGY

- (a) Do not attempt to operate this oven with the door open since open-door operation can result in harmful exposure to microwave energy. It is important not to defeat or tamper with the safety interlocks.
- (b) Do not place any object between the oven front face and the door, or allow soil or cleaner residue to accumulate on sealing surfaces.
- (c) Do not operate the oven if it is damaged. It is particularly important that the oven door close properly and that there is no damage to the:
 - (1) door (bent)
 - (2) hinges and latches (broken or loosened)
 - (3) door seals and sealing surfaces.
- (d) The oven should not be adjusted or repaired by anyone except properly qualified service personnel.

The serial number of this product may be found on the right side of the oven door opening. You should note the model number and the serial number of this oven in the space provided and retain this book as a permanent record of your purchase for future reference.

Model No. _____

Serial No. _____

Date of Purchase _____

TECHNICAL SPECIFICATIONS

	NN-T687 / NN-R687
Power Source	120V, 60 Hz
Power Consumption:	13.5 A, 1550 W
Output:*	1000 W
Outside Dimensions	12" x 21 ⁷ / ₈ " x 16 ³ / ₄ "
(H x W x D):	306 x 555 x 425mm
Oven Cavity Dimensions	9 ¹ / ₈ " x 14 ¹⁵ / ₁₆ " x 15 ¹³ / ₁₆ "
(H x W x D):	232 x 380 x 402mm
Operating Frequency:	2,450 MHz
Uncrated Weight (Approx):	38 lbs. (17.2 kg)
Stainless Trim Kit for NN-T687:	NN-TK 608,SA: L=27" (68.6 cm) NN-TK 618,SA: L=30" (76.2 cm)

*IEC 705-88 Test Procedure used

Specifications subject to change without notice.

Contents

Before Operating

Safety Instructions	2
Installation Instructions	3
Grounding Instructions	3
Practical Hints	4
Cookware and Utensil Guide	5
Feature Diagram	6
Control Panel	7
Parts & Accessories Order	41

Operation & Hints

Let's Start to Use Your Oven!	8
Quick Guide to Operation	Back Cover
To Use Function Pad	9 - 10
To Set Clock	11
Quick Min Function	10
To Reheat using	Power and Time Setting 10
	Sensor Reheat Pad 13
To Defrost using	Power and Time Setting 10
	Auto Defrost Pad 11
To Cook using	Power and Time Setting 10
	Sensor Cooking Pads 13 - 14
	Popcorn Pad 15
	Bacon Pad 15
To Set Timer (Stand Time/Delay Start)	16

Cookbook

Food Characteristics	18
Cooking Techniques	18 - 19
Appetizers	20
Meats	21 - 24
Poultry	25 - 27
Fish and Seafood	28 - 29
Casseroles	30
Eggs and Cheese	31
Vegetables	32 - 33
Pasta, Rice and Cereal	34 - 35
Quick Breads and Cakes	36 - 37
Pies	38
Microwave Shortcuts	39

Maintenance

Before Requesting Service	40
Care of Your Microwave Oven	41
Technical Specifications	Inside Front Cover

Manual de instrucciones (Spanish Operating Instructions)

Instrucciones de Seguridad	42
Instrucciones para Conexión a Tierra	43
Instrucciones de Instalación	44
Sugerencias Útiles	45
Panel de Controles	46
Procedimientos de Operación	47 - 52
Cuidados de Su Horno de Microondas	53
Antes de Acudir a Servicio	53

IMPORTANT SAFETY INSTRUCTIONS

Your microwave oven is a cooking device and you should use as much care as you use with a stove or any other cooking device. When using this electric appliance, basic safety precautions should be followed, including the following:

WARNING—To reduce the risk of burns, electric shock, fire, injury to persons or exposure to excessive microwave energy:

1. Read all instructions before using the appliance.
2. Read and follow the specific **"PRECAUTIONS TO AVOID POSSIBLE EXPOSURE TO EXCESSIVE MICROWAVE ENERGY,"** found on back of the front cover.
3. This appliance must be grounded. Connect only to properly grounded outlet. See **"GROUNDING INSTRUCTIONS"** found on page 3.
4. Install or locate this appliance only in accordance with the installation instructions found on page 3.
5. Do not cover or block any openings on this appliance.
6. Do not store or use this appliance outdoors. Do not use this product near water—for example, near a kitchen sink, in a wet basement, or near a swimming pool, and the like.
7. Use this appliance only for its intended use as described in this manual. Do not use corrosive chemicals or vapors in this appliance. This type of oven is specifically designed to heat or cook. It is not designed for industrial or laboratory use.
8. When cleaning surfaces of door and oven that come together on closing the door, use only mild, non-abrasive soaps or detergents applied with a sponge or soft cloth.
9. As with any appliance, **close supervision is necessary** when used by children.
10. Do not operate this appliance if it has a damaged cord or plug, if it is not working properly, or if it has been damaged or dropped.
11. Do not immerse cord or plug in water.
12. Keep cord away from heated surfaces.
13. Do not let cord hang over edge of table or counter.
14. This appliance should be serviced only by qualified service personnel. Contact the nearest authorized service facility for examination, repair or adjustment.
15. Some products such as whole eggs and sealed containers—for example, closed glass jars—may explode and should not be heated in this oven.
16. To reduce the risk of fire in the oven cavity:
 - (a) Do not overcook food. Carefully attend appliance if paper, plastic, or other combustible materials are placed inside the oven to facilitate cooking.
 - (b) Remove wire twist-ties from paper or plastic bags before placing bag in oven.
 - (c) If materials inside the oven should ignite, keep oven door closed, turn oven off, and disconnect the power cord, or shut off power at the fuse or circuit breaker panel.

- (d) Do not use the cavity for storage purposes. Do not leave paper products, cooking utensils, or food in the cavity when not in use.

General Use

1. **DO NOT** tamper with or make any adjustments or repairs to door, control panel housing, safety interlock switches or any other part of the oven. **DO NOT** remove outer panel from oven. Repairs should only be done by a qualified service person.

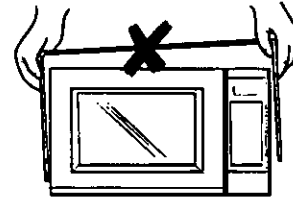

2. **DO NOT** operate the oven empty. The microwave energy will reflect continuously throughout the oven if food or water is not present to absorb energy. This could damage the oven and result in the danger of a fire.

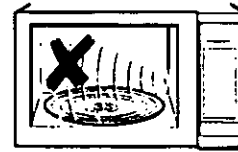

3. **DO NOT** use this oven to heat chemicals or any other non-food products. **DO NOT** clean this oven with any product that is labeled as containing corrosive chemicals. **The heating of corrosive chemicals in this oven can cause radiation leaks.**
4. **DO NOT** dry clothes, newspapers or other materials in oven. They may catch fire.
5. **DO NOT** use recycled paper products unless the paper product is labeled as safe for microwave oven use. Recycled paper products may contain impurities which may cause sparks and/or fires when used.
6. **DO NOT** use newspapers or paper bags for cooking. Fire can result.
7. **DO NOT** hit or strike control panel. Damage to controls may occur. Fire can result.
8. **POT HOLDERS** should always be used when removing items from the oven. Heat is transferred from the **HOT** food to the cooking container and from the cooking container to the Glass Tray. Glass Tray can be very **HOT** after removing cooking container from oven.
9. **DO NOT** store flammable materials next to, on top of, or in the oven. These could be fire hazards.

SAVE THESE INSTRUCTIONS

For proper use of your oven read remaining safety cautions and operating instructions.

Installation and Grounding Instructions

Examine Your Oven

Unpack oven, remove all packing material, and examine the oven for any damage such as dents, broken door latches or cracks in the door. Notify dealer immediately if oven is damaged. **Do NOT** install if oven is damaged.

Placement of Oven

- Oven must be placed on a flat, stable surface. For proper operation, the oven must have sufficient air flow. Allow 3 inches (8 cm) of space on both sides of the oven and 1 inch (2.5 cm) of space on top of oven.
 - Do NOT** block air vents.
If they are blocked during operation, the oven may overheat. If the oven overheats, a thermal safety device will turn the oven off. The oven will remain inoperable until it has cooled.
 - Do NOT** place oven near a hot damp surface such as a gas or electric range.
 - Do NOT** operate oven when room humidity is too high.
- This oven was manufactured for household use only.
- Model NN-T687 is designed exclusively to be built-in. Use the appropriate manufacturers' trim kit (see Technical Specs for the part number). Call Panasonic Customer Service for the nearest dealer [1-800-211-PANA(7262), 9 am to 9 pm EST, Toll Free].

Grounding Instructions

This appliance must be grounded. In the event of an electrical short circuit, grounding reduces the risk of electric shock by providing an escape wire for the electric current. This appliance is equipped with a cord having a grounding wire with a grounding plug. The plug must be plugged into an outlet that is properly installed and grounded.

WARNING—Improper use of the grounding plug can result in a risk of electric shock.



Consult a qualified electrician or service person if the grounding instructions are not completely understood, or if doubt exists as to whether the appliance is properly grounded.

If it is necessary to use an extension cord, use only a three wire extension cord that has a three blade grounding plug, and a three slot receptacle that will accept the plug on the appliance. The marked rating of the extension cord should be equal to or greater than the electrical rating of the appliance.

Power Supply

- A short power-supply cord is provided to reduce the risks resulting from becoming entangled in or tripping over a longer cord.
- Longer cord sets or extension cords are available and may be used if care is exercised in their use.
- If a long cord or extension cord is used, (1) the marked electrical rating of the cord set or extension cord should be at least as great as the electrical rating of the appliance, (2) the extension cord must be a grounding-type 3-wire cord, and (3) the longer cord should be arranged so that it will not drape over the countertop or tabletop where it can be pulled on by children or tripped over accidentally.

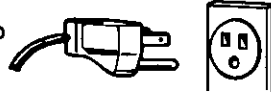
Wiring Requirements

- The oven must be on a **SEPARATE CIRCUIT**. No other appliance should share the circuit with the microwave oven. If it does, the branch circuit fuse may blow, or the circuit breaker may trip or the food may cook slower than the times recommended in this manual.
- The **VOLTAGE** used must be the same as specified on this microwave oven (120V). Using a higher voltage is dangerous and may result in a fire or other accident causing oven damage. Using a lower voltage will cause slow cooking. Panasonic is **NOT** responsible for damage resulting from the use of the oven with other than specified voltage.
- The oven must be plugged into at least a **20 AMP 120 VOLT, 60 Hz GROUNDED OUTLET**.
Where a standard two-prong outlet is encountered, it is the personal responsibility and obligation of the consumer to have it replaced with a properly grounded three-prong outlet.
- A **TEMPORARY CONNECTION** with a two-prong adapter may be made where **LOCAL CODES PERMIT**. Unless the cover screw is grounded through the house wiring, attaching the adapter grounding plate to the cover screw will not ground the oven. If there is any doubt that the cover screw is grounded, have it checked by an electrician.

Radio Interference

- Operation of the microwave oven may cause interference to your radio, TV or similar equipment.
- When there is interference, it may be reduced or eliminated by taking the following measures:
 - Clean door and sealing surfaces of the oven. (See Care of Your Microwave Oven found on page 41)
 - Place the radio, TV, etc. away from the microwave oven as far as possible.
 - Use a properly installed antenna to obtain stronger signal reception.

Practical Hints

Follow These Safety Precautions When Cooking in Your Oven

1) HOME CANNING / DRYING FOODS / SMALL QUANTITIES OF FOODS

- **Do not** use your oven for home canning or the heating of any closed jar. Pressure will build up and the jar may explode. Your oven cannot maintain the food at the proper canning temperature. Improperly canned food may spoil and be dangerous to consume.
- Small quantities of food or foods with low moisture content can dry out, burn or catch on fire.
- **Do not** dry meats, herbs, fruits or vegetables in your oven.

IMPORTANT

Proper cooking depends on time set and weight of food. If you use a smaller portion than recommended and cook at the time for the recommended portion, fire can result.

If a fire occurs, turn oven off and leave oven door closed. Disconnect the power cord or shut off power at the fuse or circuit breaker panel.

2) POPCORN

Popcorn must be popped in a microwave oven corn popper. Microwave popcorn which pops in its own package is also available. Follow popcorn manufacturers' directions and use a brand suitable for the wattage of your microwave oven. Never leave oven unattended when popping popcorn. Allow the popcorn bag to cool before opening it. To prevent steam burns, always open the bag away from your face and body.

CAUTION:

When using pre-packaged microwave popcorn, follow recommended package instructions. Check package weight before using the *Popcorn* pad. Set the oven for the weight of the popcorn package. (see page 15) If these instructions are not followed, the popcorn may not pop adequately or may ignite and cause a fire.

3) DEEP FAT FRYING

- **Do not** attempt to deep fat fry in your microwave oven. Cooking oils may burst into flames and may cause damage to the oven and perhaps result in burns. Microwave utensils may not be able to withstand the temperature of the hot oil, and could shatter or distort.

4) EGGS

- **Do not** heat eggs in their shell in a microwave oven. Pressure will build up and the eggs will explode.

5) FOODS WITH NONPOROUS SKINS

- **Potatoes, apples, egg yolks, whole squash and sausages are examples of foods with nonporous skins.** These types of foods must be pierced before microwave cooking to prevent their bursting.
- Use fresh potatoes for baking and cook until just done. Overcooking causes dehydration and may cause a fire. Use recommended weights or fire may occur.

6) LIQUIDS

- Heated liquids can erupt if not mixed with air. **Do not** heat liquids in your microwave oven without first stirring.

7) GLASS TRAY / COOKING UTENSILS / FOIL

- Cooking utensils get hot during microwaving. Use potholders when removing utensils from the oven or when removing lids or plastic wrap covers from cooking utensils to avoid burns.
- The glass tray will get hot during cooking. It should be allowed to cool before handling or before paper products, such as paper plates or microwave popcorn bags, are placed in the oven for microwave cooking.
- When using foil, skewers, warming rack or utensils made of metal in the oven, allow at least 1-inch (2.5 cm) of space between metal material and interior oven walls. If arcing occurs (sparking) remove metal material (skewers etc.) and/or transfer to a non-metallic container.
- Dishes with metallic trim should not be used, as arcing may occur.

8) PAPER TOWELS / CLOTHS

- **Do not** use paper towels or cloths which contain a synthetic fiber woven into them. The synthetic fiber may cause the towel to ignite.
- **Do not** use paper bags or recycled paper products in the microwave oven.

9) BROWNING DISHES / OVEN COOKING BAGS

- Browning dishes or grills are designed for microwave cooking only. Always follow instructions provided by the manufacturer. Do not preheat browning dish more than 8 minutes.
- If an oven cooking bag is used for microwave cooking, prepare according to package directions. Do not use a wire twist-tie to close bag.

10) THERMOMETERS

- **Do not** use a conventional meat thermometer in your oven. Arcing may occur.

11) BABY FORMULA / FOOD

- **Do not** heat baby formula or food in the microwave oven. The glass jar or surface of the food may appear warm while the interior can burn the infant's mouth and esophagus.

12) REHEATING PASTRY PRODUCTS

- When reheating pastry products, check temperature of any fillings before eating. Some foods have fillings which heat faster and can be extremely hot while the surface remains warm to the touch (ex. Jelly Donuts).

13) GENERAL OVEN USAGE GUIDELINES / OVEN DOOR

- **Do not** use the oven for any reason other than the preparation of food.
- **Do not** leave oven unattended while in use.

Cookware and Utensil Guide

ITEM	MICROWAVE	COMMENTS
Aluminum Foil	Yes for Shielding Only	Small strips of foil can be molded around thin parts of meat or poultry to prevent overcooking. Arcing can occur if foil is too close to oven wall or if too much foil is used.
Browning Dish	Yes	Browning dishes are designed for microwave cooking only. Check browning dish information for instructions and heating chart. Do not preheat for more than 8 minutes.
Brown paper bags	No	May cause a fire in the oven.
Dinnerware Microwave-Safe, only	Yes	Check manufacturers' use and care directions for suitability for microwave heating. Some dinnerware may state on the back of the dish, "Oven-Microwave Proof."
Disposable polyester Paperboard Dishes	Yes	Some frozen foods are packaged in these dishes. Can be purchased in grocery stores.
Fast Food Carton with Metal Handle	No	May cause arcing.
Frozen Dinner Tray Metal	Yes	Frozen dinners may be heated in foil tray, if tray is less than ¾-inch (2 cm) high. Place foil tray in center of oven. Leave at least 1-inch (2.5 cm) space between foil tray and oven walls. Heat only 1 foil tray in the oven at time. For containers more than ¾-inch (2 cm) deep, remove food and place in a similar size microwave-safe container.
Microwave-safe	Yes	
Glass Jars	Yes	Remove lid. Heat food until just warm. Most glass jars are not heat resistant.
Glassware Heat Resistant Oven Glassware and Ceramic, only	Yes	Ideal for microwave cooking and browning, (see Container Test below)
Metal Twist Ties	No	They may cause arcing which could cause a fire in the oven.
Oven Cooking Bag	Yes	Follow manufacturers' directions. Close bag with the nylon tie provided, a strip cut from the end of the bag, or a piece of cotton string. Do not close with metal twist tie. Make six ½-inch (1 cm) slits by closure.
Paper Plates & Cups	Yes	Use to warm cooked foods, and to cook foods that require short cooking times such as hot dogs.
Paper Towels & Napkins	Yes	Use to warm rolls and sandwiches by microwave.
Plastic Microwave-Safe, only Cookware and Storage Dishes	Yes	Should be labeled, "Suitable for microwave heating." Check manufacturers' directions for recommended uses. Some microwave-safe plastic dishes are not suitable for cooking foods with high fat content.
Plastic Foam Cups	Yes	Plastic foam will melt if foods reach a high temperature. Use to bring foods to a low serving temperature.
Plastic Wrap	Yes	Use to cover food during cooking to retain moisture.
Straw, Wicker, Wood	Yes	Use only for short term reheating. Use to bring food during cooking to retain moisture.
Thermometers Microwave-safe, only Conventional	Yes No	Use only microwave-safe meat and candy thermometers. Not suitable for use in microwave oven.
Wax paper	Yes	Use as a cover to prevent spattering and to retain moisture.

Container Test

TO TEST A CONTAINER FOR SAFE MICROWAVE OVEN USE: Fill a 1-cup glass measure with water and place it in the microwave oven along with the container to be tested; **heat one minute at HIGH**. If the empty container is microwave oven-safe, it should remain comfortably cool and the water should be hot. If the container is hot, it has absorbed some microwave energy and should not be used. This test cannot be used for plastic containers.

Feature Diagram

Glass Tray

1. Do not operate the oven without the Roller Ring and Glass Tray in place.
2. Only use the Glass Tray specifically designed for this oven. Do not substitute any other Glass Tray.
3. If Glass Tray is hot, allow to cool before cleaning or placing in water.
4. **Do not** cook directly on Glass Tray. Always place food in a microwave-safe dish, or on a rack set in a microwave-safe dish.
5. If food or utensil on Glass Tray touches oven walls, causing the tray to stop moving, the tray will automatically rotate in opposite direction. This is normal.
6. Glass tray can rotate in either direction.

See-through Oven Window with Vapor Barrier (do not remove)

Door Safety Lock System

External Air Vents

Internal Air Vents

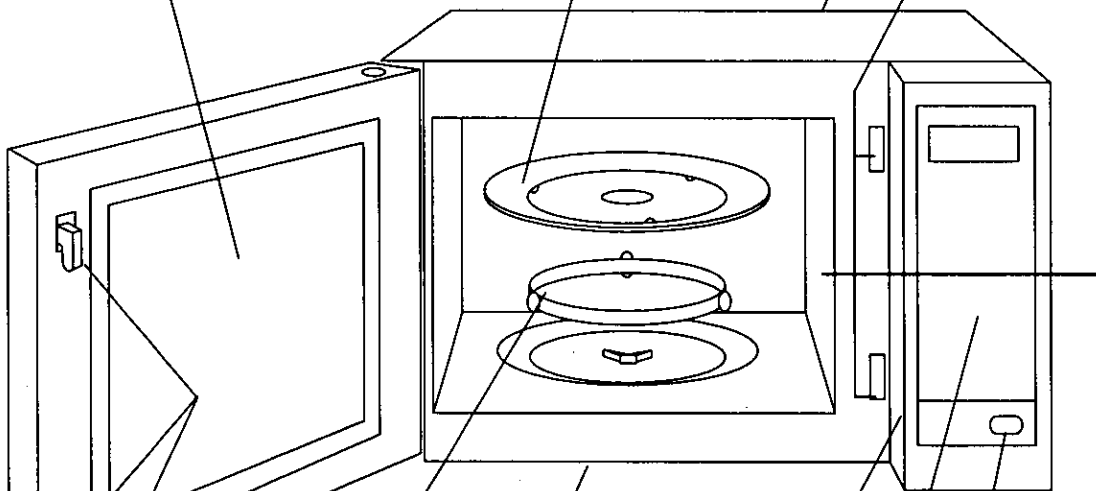

External Air Vents

Identification Plate

Control Panel

Roller Ring

1. The Roller Ring and oven floor should be cleaned frequently to prevent excessive noise.
2. The Roller Ring must always be used together with the Glass Tray for cooking.

Door Safety Lock System

Door Release Button

Press to open the door.
Opening the door during cooking will stop the cooking process without canceling the program. Cooking resumes as soon as the door is closed and Start Pad is pressed. The oven light will stay on or turn on whenever the door is opened.

Control Panel

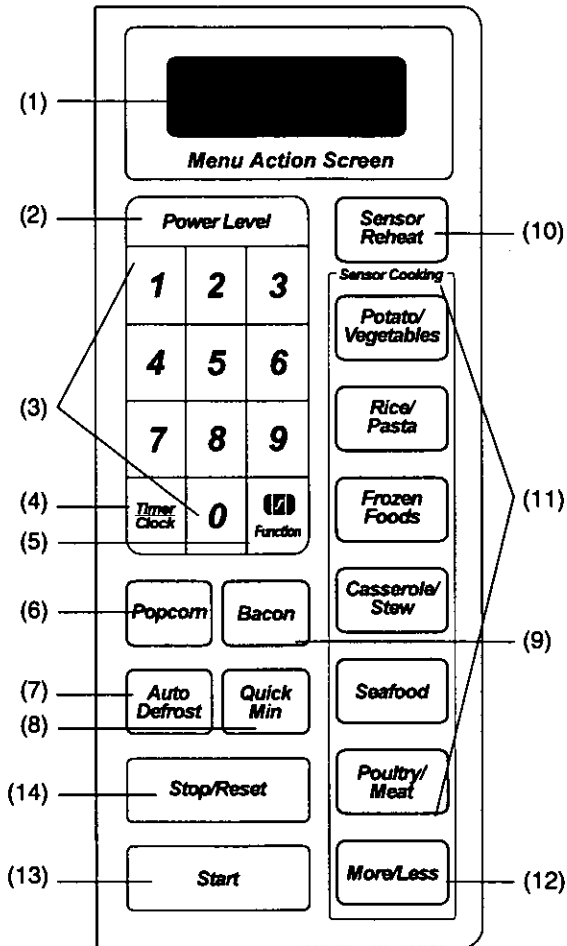

(1) Menu Action Screen

Step by step instructions scroll for easy operation.

(2) Power Level Pad (☛page 10)

(3) Number Pads

(4) Timer/Clock Pad (☛pages 11, 16)

(5) Function Pad (☛pages 8-9)

(6) Popcorn Pad (☛page 15)

(7) Auto Defrost Pad (☛page 11)

(8) Quick Min Pad (☛page 10)

(9) Bacon Pad (☛page 15)

(10) Sensor Reheat Pad (☛page 13)

(11) Sensor Cooking Pads (☛pages 13-14)

(12) More/Less Pad

(13) Start Pad:

One tap allows oven to begin functioning. If door is opened or **Stop/Reset** Pad is pressed once during oven operation, **Start** Pad must be pressed again to restart oven.

(14) Stop/Reset Pad:

Before cooking: One tap clears your instruction.

During cooking: One tap temporarily stops the cooking process. Another tap cancels all your instructions and time of day appears on the display screen.

Prompters (Normal Operation):

When pads are pressed, a beep sound is heard and the corresponding letter or word(s) appear and scrolls across the screen. If a pad is pressed and no beep is heard, the unit has not or cannot accept the instruction. As each pad is pressed the corresponding word(s) scroll across the screen. Words will automatically appear to prompt user to perform the next step. It is not necessary to wait for the words to appear before pressing pads for the next step. A two beep sound is heard between stages. At the end of any complete program, the oven will beep five times and "ENJOY YOUR MEAL" will appear on the screen.

Let's Start to Use Your Oven!

1 Plug in

Plug into a properly grounded electrical outlet.

Conversion:

The display automatically appears in English with weight measurement in Imperial. If you wish to use Spanish or French and/or the Metric System, use Function Pad (below). The conversion should be programmed directly after plugging the oven in. It can be changed at any time using Function Pad.

2 Place a cup of water in the oven

Open the door and place a cup of water on the Glass Tray in the oven. Then close the door.



3 Select Power Level

e.g. MEDIUM Power — Press **Power Level** Pad four times (see page 10 for chart)

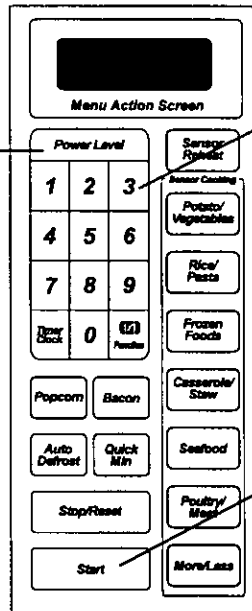

4 Set Cooking Time using number pads



e.g. 1 minute 30 seconds



5 Press Start

➤ The time in the Menu Action Screen will count down.

To Use Function Pad

1) 	Press "Select Function".
2) 	Select choice <input type="text" value="0"/> - <input type="text" value="9"/> Menu Action Screen displays all options available
3) <input type="text" value="1"/> <input type="text" value="2"/> <input type="text" value="3"/>	Select option <input type="text" value="1"/> , <input type="text" value="2"/> or <input type="text" value="3"/> Menu Action Screen displays all options available.

Functions

This unique feature of your PANASONIC microwave oven allows you to establish the initial non-cooking features of your oven such as CHILD LOCK, WORD SPEED, LANGUAGE CHOICE (ENGLISH, SPANISH OR FRENCH), plus many more. See below.

	<p>1 LANGUAGE CHOICE</p> <p>The oven has English, French and Spanish display. The display appears in English when you plug-in.</p> <ul style="list-style-type: none"> 1 ENGLISH → Display appears in English. 2 FRANCAIS → Display appears in French. 3 ESPANOL → Display appears in Spanish.
	<p>2 Lb/KG CHOICE</p> <p>The oven has both imperial and metric weight measurements. The oven displays the weight in imperial when you plug it in.</p> <ul style="list-style-type: none"> 1 Lb → Weight can be set in lb/oz, (Imperial). 2 KG → Weight can be set in kg/g, (Metric).
	<p>3 WORD SPEED</p> <p>The speed of word scrolling in the Display Window can be quickened or slowed down.</p> <ul style="list-style-type: none"> 1 QUICK → Words scroll quickly. 2 MEDIUM → Scrolling speed reverts to initial setting. 3 SLOW → Words scroll slowly.
	<p>4 MENU ACTION ON/OFF</p> <p>MENU ACTION SCREEN helps you to program your oven by prompting the next step to be taken. When you become familiar with your oven, the prompting can be turned off.</p> <ul style="list-style-type: none"> 1 ON → Prompting Guide will reappear. 2 OFF → Prompting Guide will not appear.
	<p>5 CHILD LOCK ON/OFF</p> <p>The oven has Child Safety Lock feature which prevents use by children. It does not lock the door.</p> <ul style="list-style-type: none"> 1 ON → Child Lock has been set and operation will not be accepted. 2 OFF → Child Lock has been cancelled.
	<p>6 BEEP ON/OFF</p> <p>If you wish to have the oven operate with no beep, it can be eliminated.</p> <ul style="list-style-type: none"> 1 ON → Beep sound will reactivate. 2 OFF → Beep sound will not be heard.
	<p>7 REMINDER BEEP ON/OFF</p> <p>A reminder beep works to remind you to remove the food from the oven after the completion of cooking. It will occur every few seconds.</p> <ul style="list-style-type: none"> 1 ON → Reminder beep will work. 2 OFF → Reminder beep will not work.
	<p>8 DAYLIGHT SAVING ON/OFF</p> <ul style="list-style-type: none"> 1 ON → Time of day will advance one hour. 2 OFF → Time of day revert to original setting.
	<p>9 CLOCK ON/OFF</p> <p>Clock display can be turned off.</p> <ul style="list-style-type: none"> 1 ON → Clock display will appear in the Display Window. 2 OFF → Clock display will not appear in the Display Window. <p>Time of day will not be lost while the display is off.</p>
	<p>0 DEMO MODE ON/OFF</p> <p>Demo mode is designed for retail store display. In this mode, the oven can be demonstrated with no power in the oven.</p> <ul style="list-style-type: none"> 1 ON → The oven will be in demo mode. 2 OFF → The oven will be out of demo mode.

Power & Time Setting

1 Select Power Level

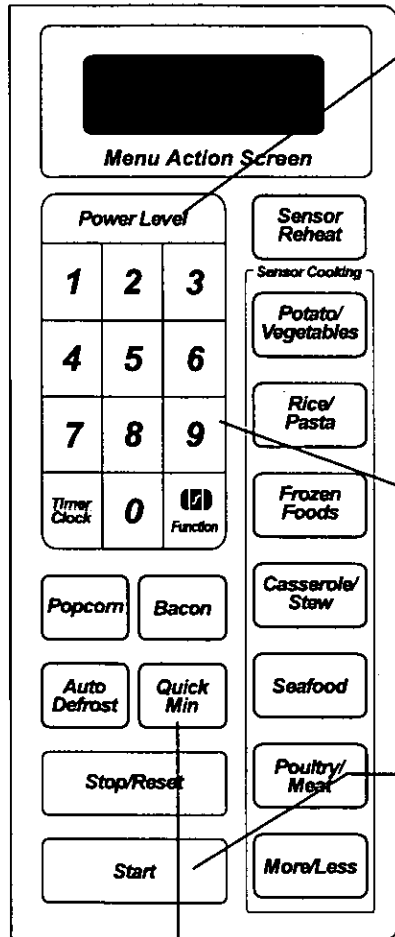

Press	Power Level	% Power
once	HIGH	100%
twice	DEFROST	30%
3 times	MEDIUM-HIGH	70%
4 times	MEDIUM	55%
5 times	MEDIUM-LOW	30%
6 times	LOW	10%

When selecting **HIGH** Power, you can start from step 2.
To reheat, select **MEDIUM-HIGH** or **MEDIUM**.

2 Set Cooking Time

(Up to 99 minutes and 99 seconds) e.g. 12 minutes

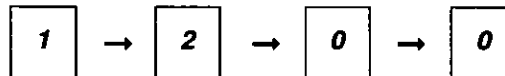

3 START

► Cooking will start.
The time in the Display Window will begin to count down.

To recall the selected power level during cooking, press Power Level Pad.

For 2 or 3 stage cooking, repeat above steps 1 and 2 before pressing Start Pad.

Quick Min Function

This function 1) helps you in programming cooking time easily and 2) allows you to add extra cooking time.

1) To Set Cooking Time:



Press to set cooking time (up to 10 taps/minutes) after selecting the desired power level, and then press **Start**. If you set cooking time without selecting power level, oven automatically selects High Power.

NOTE: After setting the time by Quick Min Pad, you cannot use Number Pads, and vice versa.

2) To Add Extra Cooking Time:



Press to add extra cooking time (up to 10 taps) during cooking.

► Cooking time changes to include extra time and continues to count down in the display window.

Auto Defrost

This feature allows you to defrost meat, poultry and seafood by weight without setting time.

1 Press Auto Defrost Pad

to set the weight of food.

Weight of the frozen food must be programmed in pounds and ounces or kg/g (see page 9 for selecting weight system).

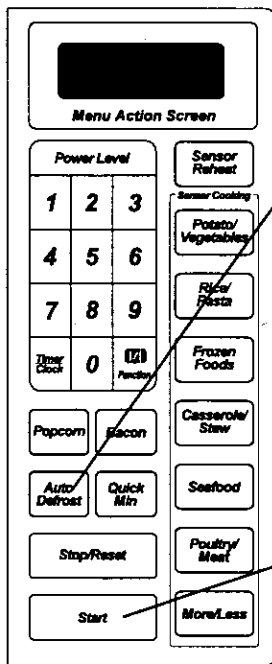

2 Press START

► Defrosting time appears in the Menu Action Screen and begins to count down.

Conversion Chart

Follow this chart to convert tenths of a pound into ounces. If a piece of meat weighs 1.9 pounds, program 1 pound 14 ounces.

Tenths of a Pound	Ounces
0.0	0
0.1	1 - 2
0.2	3 - 4
0.3	5
0.4	6 - 7
0.5	8
0.6	9 - 10
0.7	11 - 12
0.8	13
0.9	14 - 15

NOTE:

1. The shape and size of the food will determine the maximum weight the oven can accommodate. The recommended **maximum weight of meat is 4 lb (1.8 kg); poultry, 6 lb (2.7 kg) and seafood, 3 lb (1.4 kg).**
2. The oven beeps once during the defrosting cycle to signal that the food needs to be **turned or rearranged**. To prevent overdefrosting, thin areas of edges can be shielded with strips of aluminum foil.
3. For best results, the minimum recommended weight **8 oz. (220 g).**
4. Stand time or power level may be programmed after Auto Defrost.

Clock Setting

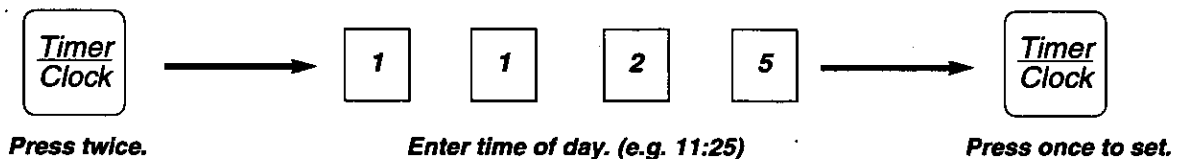

NOTE:

1. You can use the oven without setting the clock.
2. There is no a.m. or p.m. settings. Clock is a 12 hour display.
3. To reset time of day, repeat the steps above.
4. The clock will retain time setting only when plugged into power source.

Defrosting Tips & Techniques

1. Freeze meats, poultry and fish in packages with **only 1 or 2 layers** of food. Place wax paper between layers.
2. **Package** in heavy-duty plastic wraps, bags or freezer paper.
3. **Remove as much air** as possible.
4. Wrap should be snug against food, sealed securely and labeled.
5. **Remove wrapper** to prevent holding steam and juice. **Juice of food** can get hot and cause the outer surface or bottom of the food to cook; set the food on a microwave roasting rack and drain liquid during defrosting.
6. **Place meat in an appropriate size dish.**
7. **Place roast fat-side down and whole poultry breast-side down** on a microwave roasting rack in a dish.
8. Place small items on a microwave roasting rack in a dish.
9. **Large roasts and whole poultry** may still be icy in center after defrosting, allow to stand in the refrigerator covered with plastic wrap (see chart below).
10. Fish and seafood should be slightly icy after defrosting, allow to stand and rinse under cold water for 2-3 minutes.
11. Defrosted items in 2 layers should be **rinsed separately** or **have a longer stand time.**

FOOD	DEFROST TIME (min. per pound)	DURING DEFROSTING	AFTER DEFROSTING	
			Stand Time	Rinse
Fish and Seafood [up to 3 lb. (1.5 kg)]				
Crabmeat	12 to 14	Break apart	5 min.	NO
Fish Steaks	6 to 10	Turn over		
Fish Fillets	6 to 8	Turn over/Rearrange		
Sea Scallops	14 to 16	Break apart/Remove defrosted pieces	5 min.	YES
Shrimp medium	8 to 10	Break apart/Remove defrosted pieces		
Whole fish	10 to 12	Turn over		
Meat				
Ground Meat	8 to 10	Turn over/Remove defrosted portion/Shield edges	10 min.	NO
Roasts [2½ - 4 lb. (1.2 - 2 kg)]	8 to 12	Turn over/Shield ends and defrosted surface	30 min. in refrig	
Chops/Steak	8 to 10	Separate/Turn over/Rearrange	5 min.	
Ribs/T-bone	8 to 10	Turn over/Shield		
Stew Meat	10 to 12	Break apart/Shield		
Liver (thin sliced)	8 to 10	Drain liquid/Turn over/Separate pieces		
Bacon	4 to 6	Turn over		
Poultry				
Chicken, Whole [up to 3 lb. (1.5 kg)]	6 to 10	Turn over 2 or 3 times/Shield defrosted parts	30 min. in refrig	YES
Cutlets	6 to 8	Turn over	5 min.	NO
Pieces	8 to 10	Separate	10 min.	
Corish Hens	8 to 12	Turn over/Rearrange		
Turkey Breast [5 - 6 lbs. (2.5 - 3 kg)]	8 to 12	Turn over 2 to 3 times	30 min. in refrig	

Sensor Reheat / Sensor Cooking

The GENIUS feature allows you to reheat/cook most of your favorite foods without having to select reheating/cooking times and power levels. The oven does it all automatically.

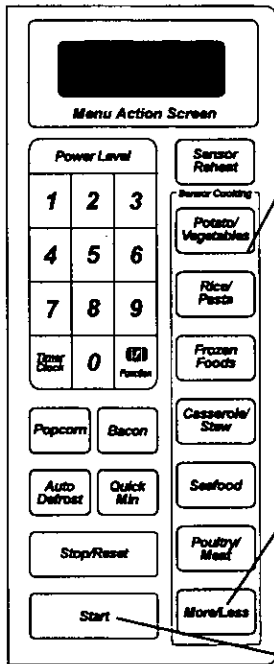

1 Select Category

Sensor Cooking Pads each have several categories. See next page.

More/Less Pad:

Preferences for food doneness vary with each individual. After having used Sensor Cooking a few times, you may decide you would prefer your food cooked to a different doneness. By using the More/Less Pad, the programs can be adjusted to cook food for a longer or shorter time.

1 tap: More cooking

2 taps: Less cooking

Press More/Less Pad before pressing

2 Press START

► Cooking will start.

After the burst of steam is detected by the SENSOR, the remaining cooking time appears in the Menu Action Screen and begins to count down. Do not open door until time appears in the Menu Action Screen.

To recall the selected category during cooking, press any Sensor Cooking Pad. The category will appear in the display.

NOTES ON SENSOR REHEAT:

Follow the recommendations on page 14, in addition to the following:

DO NOT:

1. Reheat bread and pastry products. Use manual power and time.
2. Reheat raw or uncooked food.
3. Use if oven cavity is warm.
4. Use for frozen beverages.
5. Use for frozen foods.

Casseroles - Add 2 to 4 tablespoons of liquid; cover with lid or plastic wrap. Stir when time appears in the Display Window.

Canned foods - Empty contents into casserole dish or serving bowl; cover dish with lid or plastic wrap. After reheating, release plastic wrap and stand.

Plate of food - Arrange food on plate; top with butter, gravy, etc. After reheating, release plastic wrap and stand.

Food	Starting Temp.	Average Weight per Serving	Number of Servings
Plate of Food	Refrig.	12 - 16 oz.	any size
Meat, Poultry	Refrig.	4 - 6 oz.	any size
Casseroles	Refrig.	8 oz.	any size
Side dishes	Refrig. or Room	4 - 6 oz.	any size
Soups, Sauces, Gravies	Refrig. or Room	6 - 8 oz.	any size

Sensor Cooking

	CATEGORY	WEIGHT RANGE	INSTRUCTIONS
Potato/ Vegetables	1 x Potato	1 - 4 potatoes any size	Pierce several times and place on a microwave safe dish. Do not cover. After beep, turn over.
	2 x Fresh Vegetables	any quantity	Add small amount of water. Cover loosely with a lid or plastic wrap. After beep, stir or rearrange.
	3 x Frozen Vegetables	any quantity	Add 2 tbsp of water. Do not cook with butter or sauce. Cover with plastic wrap. After beep, stir or rearrange.
Rice/Pasta	1 x Rice	Rice Cold water ½ cup 1 cup 1 cup 2 cups 1½ cup 3 cups 2 cups 3½ cups	Place rice and cold water with ¼ to 1 teaspoon salt. Cover with lid or plastic wrap. After beep, stir several times. After cooking, stir and let stand 5 to 10 mins.
	2 x Pasta	4 - 8 oz. (120 - 230 g)	Place ½-quarts of hot water, pasta, 1 tbsp. oil and 1 tsp. salt in a 4-qt. casserole. Cover with lid. After beep, stir occasionally. After cooking, rinse pasta with cold water.
Frozen Foods	1 x Frozen Entrees	any size	Follow manufacturers' directions for covering or removing covers. For best results, do not use frozen foods packaged in foil tray. After beep, stir if possible or ladle gravy or sauce over.
	2 x Frozen Dinners	any size	
Casserole/ Stew	1 x Casserole	1 - 4 qt.	Use appropriate amount of liquid. Cover with casserole lid. Stir occasionally or rearrange after beep. Use recipes in the Cooking Guide section.
	2 x Stew	1 - 4 qt.	
Seafood	1 x Fish Fillets	min. ½ lb.	Arrange in a single layer in dish. Cover with lid or plastic wrap. Stir or rearrange after beep.
	2 x Shellfish	min. ½ lb.	
Poultry/Meat	1 x Chicken Pieces	min. ½ lb.	Place skin-side up. Cover with plastic wrap. Rearrange after beep.
	2 x Whole Chicken	up to 6 lb. (3 kg)	Place breast-side down. Cover completely with plastic wrap. After beep, turn breast-side up, recover.
	3 x Pork (roast)	2 - 4 lb. (1 - 2 kg)	Place fat-side down. Cover with plastic wrap. After beep, turn over, recover, shield ends of roast with foil if necessary. Pork must reach 170°F (77°C) before serving.
	4 x Beef-medium	2 - 4 lb. (1 - 2 kg)	Place fat-side up. Cover with plastic wrap.

For best results by Sensor, follow these recommendations.

BEFORE Reheating/Cooking:

1. The room temperature surrounding the oven should be below 95°F (35°C).
2. Food weight should be between 4 oz (120 g) and 24 oz (680 g).
3. Glass Tray and outside of container should be dry.
4. Cover foods loosely, but completely, with plastic wrap or place foods in a casserole dish with a proper fitting lid.
5. All foods should be taken from their normal storage place.

DURING Reheating/Cooking:

While "AUTO" is displayed in the Display Window, DO NOT open door. This causes inaccurate cooking results. Once the timer begins to count down, the oven door may be opened to stir, turn, shield or add foods.

AFTER Reheating/Cooking:

All foods should have a covered stand time.

Popcorn Function

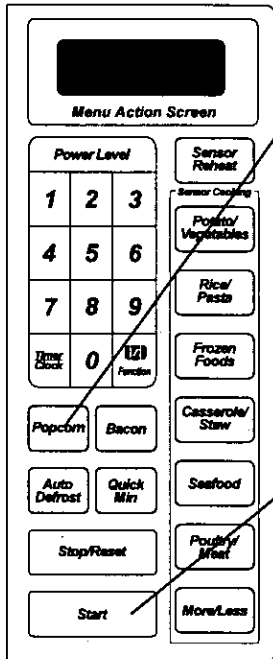

1 Select the Weight

of prepackaged microwave popcorn.

Press	Weight	
once	3.5 oz.	(99 g)
twice	3.0 oz.	(90 g)
three times	1.75 oz.	(50 g)

2 Press START

➤ Cooking time appears and begins to count down.

NOTE:

1. Use prepackaged **room temperature** microwave popcorn. Read manufacturers' instructions.
2. Place bag in oven according to manufacturers' directions.
3. Pop only one bag at a time.
4. After popping, allow the contents of the bag to cool for a few minutes before opening. Open bag carefully away from face and body because popcorn and steam are extremely hot.
5. Do not reheat unpopped kernels or reuse bag.
6. **Never** leave oven unattended when popping popcorn.

CAUTION: If pre-packaged popcorn is of a different weight than the recommended weight, do not use the popcorn setting, or inadequate popping or a fire may occur. Follow the manufacturers' instructions.

Bacon Pad

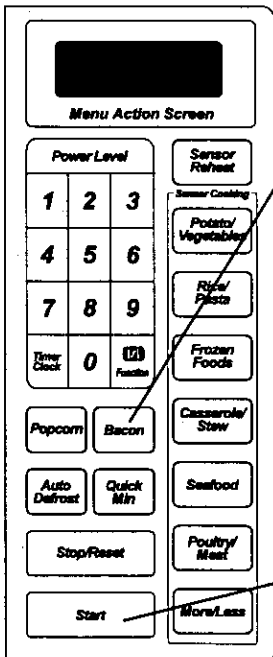

1 Select the Number of Slices

Place slices on a microwave safe dish. Cover with paper towel to absorb grease spatters.

PRESS	AMOUNT
once	2 slices
twice	3 slices
3 times	4 slices
4 times	6 slices

2 Press START

➤ Cooking time appears and begins to count down.

Timer Function

This feature allows you to program a standing time after cooking is completed and to program the oven as a minute timer and/or to program delay start.

To Use as a Timer

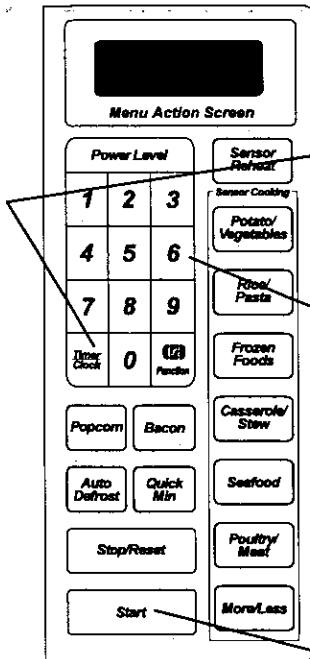

1 Press *Timer* once

2 Set *desired amount of Time*

(up to 99 minutes and 99 seconds)

3 Press *Start*

▶ Time will count down without oven operating.

To Set Stand Time

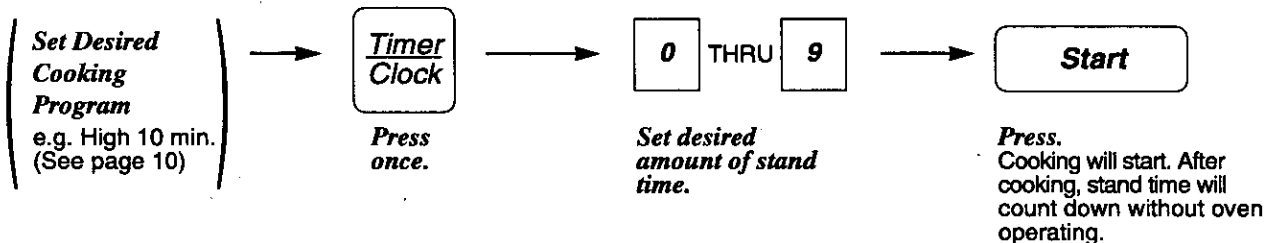

To Set Delay Time

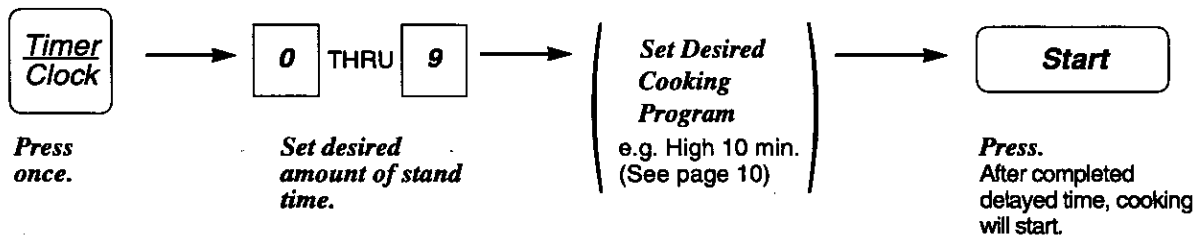

NOTE:

1. When the first/second stage has finished, a two beep signal is heard. After all the stages have been completed, the oven will beep five times.
2. If oven door is opened during the Stand Time of Kitchen Timer, the time in the Display Window will continue to count down.
3. Delay Start cannot be programmed before any Auto Control Function. This is to prevent the starting temperature of the food from rising before defrosting or cooking begins. A change in the starting temperature could cause inaccurate cooking results.
4. Timer can be set up to 99 minutes and 99 seconds.

Food Characteristics

Bone and Fat

Both bone and fat affect cooking. Bones may cause irregular cooking. Meat next to the tips of bones may overcook while meat positioned under a large bone, such as a ham bone, may be undercooked. Large amounts of fat absorb microwave energy and the meat next to these areas may overcook.

Density

Porous, airy foods such as breads, cakes or rolls take less time to cook than heavy, dense foods such as potatoes and roasts. When reheating donuts or other foods with different centers be very careful. Certain foods have centers made with sugar, water or fat and these centers attract microwaves (For ex., jelly donuts). When a jelly donut is heated, the jelly can become extremely hot while the exterior remains warm to the touch. This could result in a burn if the food is not allowed to cool properly in the center.

Quantity

Two potatoes take longer to cook than one potato. As the quantity of the food increases so does the cooking time. When cooking small amounts of food such as one or two potatoes, do not leave oven unattended. The moisture content in the food may decrease and a fire could result.

Shape

Uniform sizes heat more evenly. The thin end of a drumstick will cook more quickly than the meaty end. To compensate for irregular shapes, place thin parts toward the center of the dish and thick pieces toward the edge.

Size

Thin pieces cook more quickly than thick pieces.

Starting Temperature

Foods that are room temperature take less time to cook than if they are chilled or refrigerated or frozen.

Cooking Techniques

Piercing

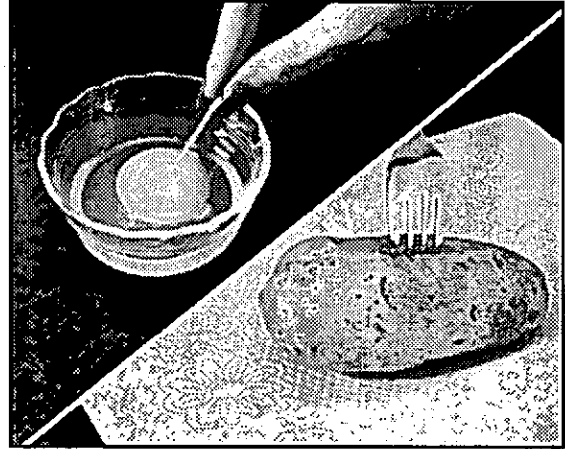

Foods with skins or membranes must be pierced, scored or have a strip of skin peeled before cooking to allow steam to escape. Pierce whole egg yolks and whites, clams, oysters, chicken livers, whole potatoes and whole vegetables. Whole apples or new potatoes should have a 1-inch strip of skin peeled before cooking. Score sausage and frankfurters.

Browning



Foods will not have the same brown appearance as conventionally cooked foods or these foods which are cooked utilizing the browning feature. Meats and poultry may be coated with browning sauce, Worcestershire sauce, barbecue sauce or shake-on browning sauce. To use, combine browning sauce with melted butter or margarine; brush on before cooking.

For quick breads or muffins brown sugar can be used in the recipe in place of granulated sugar, or the surface can be sprinkled with dark spices before baking.

Cooking Techniques

Spacing

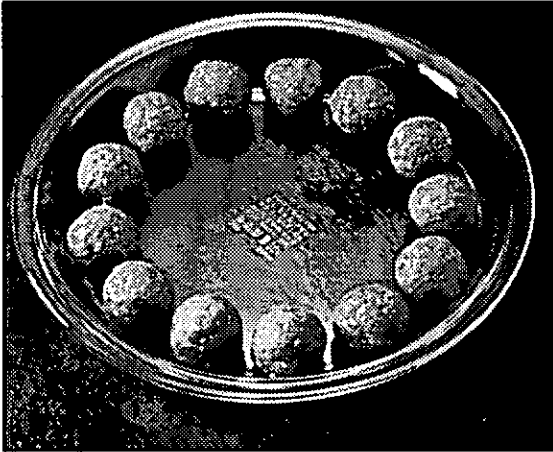

Individual foods, such as baked potatoes, cupcakes and appetizers, will cook more evenly if placed in the oven equal distances apart. When possible, arrange foods in a circular pattern.

Covering

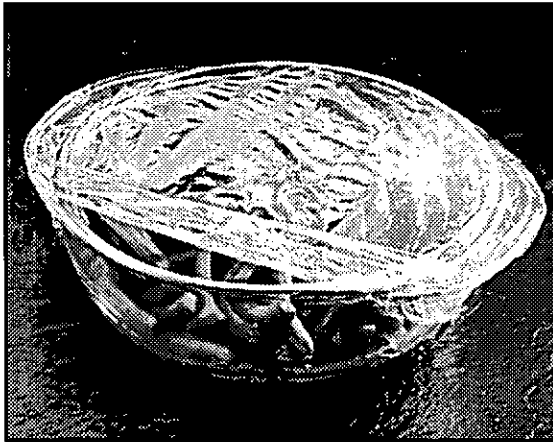

As with conventional cooking, moisture evaporates during microwave cooking. Casserole lids or plastic wrap are used for a tighter seal. When using plastic wrap, vent the plastic wrap by folding back part of the plastic wrap from the edge of the dish to allow steam to escape. Loosen or remove plastic wrap as recipe directs for stand time. When removing plastic wrap covers, as well as any glass lids, be careful to remove them away from you to avoid steam burns. Various degrees of moisture retention are also obtained by using wax paper or paper towels. However, unless specified, a recipe is cooked uncovered.

Shielding

Thin areas of meat and poultry cook more quickly than meaty portions. To prevent overcooking, these thin areas can be shielded with strips of aluminum foil. Wooden toothpicks may be used to hold the foil in place.

Timing

A range in cooking time is given in each recipe. The time range compensates for the uncontrollable differences in food shapes, starting temperature and regional preferences. Always cook food for the minimum cooking time given in the recipe and check for doneness. If the food is undercooked, continue cooking. It is easier to add time to an undercooked product. Once the food is overcooked, nothing can be done.

Stirring

Stirring is usually necessary during microwave cooking. We have noted when stirring is helpful, using the words once, twice, frequently or occasionally to describe the amount of stirring necessary. Always bring the cooked outside edges toward the center and the less cooked center portions toward the outside of the dish.

Rearranging

Rearrange small items such as chicken pieces, shrimp, hamburger patties or pork chops. Rearrange pieces from the edge to the center and pieces from the center to the edge of the dish.

Turning

It is not possible to stir some foods to redistribute the heat. At times microwave energy will concentrate in one area of a food. To help insure even cooking, these foods need to be turned. Turn over large foods, such as roasts or turkeys, halfway through cooking.

Stand Time

Most foods will continue to cook by conduction after the microwave oven is turned off. In meat cookery, the internal temperature will rise 5°F to 15°F (3°C to 8°C) if allowed to stand, tented with foil, for 10 to 15 minutes. Casseroles and vegetables need a shorter amount of standing time, but this standing time is necessary to allow foods to complete cooking in the center without overcooking on the edges.

Testing for Doneness

The same tests for doneness used in conventional cooking may be used for microwave cooking. Meat is done when fork-tender or splits at fibers. Chicken is done when juices are clear yellow and drumstick moves freely. Fish is done when it flakes and is opaque.

Appetizers

ORIENTAL DUMPLINGS

Filling:

- 1/2 pound cooked pork, finely chopped
- 1/2 pound shrimp, cleaned and finely chopped
- 1/4 cup finely chopped green onions
- 1 tablespoon chopped parsley
- 1 jalapeño pepper, finely chopped
- 1 teaspoon salt
- 1/2 teaspoon pepper
- 1 egg white

Wonton wrappers, (Approximately 1 lb.)
Water

Yield: Approximately 45 Dumplings

In medium bowl combine all filling ingredients. Place a teaspoon of filling mixture in center of a wonton wrapper. Wet inside edges of wrapper with small amount of water. Fold top left and bottom right corner of wrapper over filling and press together to seal.

Place 11 dumplings on microwave safe rack. Heat 1 1/2 cups water in 2-cup glass measure at **HIGH** 2 1/2 to 3 minutes. Pour water into bottom of 4-quart casserole. Set rack with dumplings in casserole dish. (Rack should be high enough so water does not reach bottom of dumplings.) Brush dumplings with water. Cover with lid. Heat at **HIGH** 2 1/2 to 3 minutes. Turn dumplings over; brush with water. Recover. Heat at **HIGH** 2 1/2 to 3 minutes. Repeat with remaining dumplings. Serve with plum sauce or other dipping sauces.

STUFFED ZUCCHINI

- 3 zucchini
- 1 tablespoon olive oil
- 2 cloves garlic, chopped
- 1/2 onion, chopped
- 1 tomato, chopped
- 1/2 teaspoon pepper
- 1/4 teaspoon oregano
- 1/4 teaspoon basil
- 1/4 teaspoon parsley

Yield: 16 to 20 Appetizers

Halve zucchini lengthwise. Scoop out pulp and set aside. In a small bowl, combine olive oil, garlic and onion. Cook at **HIGH** 1 1/2 minutes. Add zucchini pulp, tomato, pepper, oregano, basil and parsley. Cook at **HIGH** 2 minutes. Stir once. Drain mixture and set aside. Pat zucchini shells dry. Place tomato mixture in each shell. Cut into bite-size pieces. Place on a microwave- and heat-safe serving plate.

Cook at **HIGH** 6 to 7 minutes. Let stand, uncovered, 2 minutes before serving.

ORIENTAL SPARERIBS

- 2 pounds pork spareribs, cut in 1 rib portions
- 1/2 cup soy sauce
- 1/3 cup honey
- 1/4 cup green onion, finely chopped
- 1 tablespoon rice wine vinegar
- 1/2 to 1 tablespoon fresh ginger, finely chopped
- 1/4 teaspoon crushed red pepper
- 2 cloves garlic, finely chopped

Yield: 20 Appetizers

Arrange ribs meat-side down in a 2 1/2-quart shallow oval casserole dish. Combine remaining ingredients. Brush ribs with marinade.

Cook at **HIGH** 7 to 8 minutes. Turn ribs over and baste with marinade. Cook at **MEDIUM** 7 to 8 minutes, or until ribs are tender.

STUFFED MUSHROOMS

- 1 pound medium mushrooms (about 24), cleaned
- 4 slices bacon, chopped
- 1 small onion, finely chopped
- 1/2 cup dry bread crumbs
- 1/2 cup white wine or water
- 1/4 cup grated Parmesan cheese
- 1/4 teaspoon pepper

Yield: 24 Mushrooms (about 6 Servings)

Remove stems from mushrooms. Finely chop enough stems to equal 1 cup; set aside. Place bacon and onion in bowl. Cook at **HIGH** 5 to 6 1/2 minutes, or until bacon is crisp and onion is tender; stir once. Drain. Stir in chopped mushroom stems, bread crumbs, wine, cheese and pepper. Stuff mushroom caps with bread crumb mixture. Arrange half of mushrooms in a circular pattern in a 9-inch microwave-safe pie plate.

Cover with wax paper. Cook at **HIGH** 5 to 5 1/2 minutes. Let stand, uncovered, 2 minutes before serving. Repeat procedure with remaining mushrooms.

Meats

Directions for Roasting Meats

Tender cuts, such as beef and lamb roasts should be covered with wax paper to prevent spatter. For pork roasts or hams, cover with plastic wrap or place in an oven cooking bag.

Less tender cuts, such as pot roasts, should be cooked in liquid. Use 1 cup of liquid such as soup or broth per pound of meat. Use an oven cooking bag or covered casserole. Select a covered casserole deep enough so that the meat does not touch the lid.

TO COOK BY TIME:

Multiply the weight of the roast by the minimum recommended minutes per pound. Program Power and Time.

TO COOK BY SENSOR COOKING:

Place meat according to "Special Instructions" below. Cover with plastic wrap. Turn Pork Roast fat-side up halfway through cooking time.

Press Poultry/ Meat
three times for "PORK", four times for "BEEF-MEDIUM".

If you want roast slightly over or under cooked, use **MORE/LESS** Pad. The sensor will make the adjustment.

Meat Roasting Chart for Sensor & Time Cooking

MEAT	SENSOR COOKING CATEGORY	POWER & TIME COOKING [time in min/lb. (450 g)]		TEMP. AFTER COOKING	SPECIAL INSTRUCTIONS
BEEF ROASTS [2½ to 4 Lb. (1.2 to 2 kg)] Rib/Boneless Rib/Top Sirloin Rare Medium Well Rump, Eye of round (High Quality)	—	MEDIUM	9 to 11	130°F (55°C)	Place roast fat-side up. Cover roast with plastic wrap.
	BEEF-MEDIUM	MEDIUM	12 to 14	140°F (60°C)	
	—	MEDIUM	14½ to 16½	160°F (70°C)	
	—	MEDIUM	9 to 12	130°F (55°C)	
BEEF POT ROAST [2½ to 3½ Lb. (1.2 to 1.7 kg)] Chuck, Rump	—	MEDIUM	30 to 35	—	Cover meat with liquid. Turn meat over half of cooking time.
		LOW			
PORK ROASTS [2½ to 4 Lb. (1.2 to 2 kg)] Bone-in Boneless	PORK	MEDIUM	15 to 18	170°F (77°C)	Place roast fat-side down. Cover pork with plastic wrap. Turn over halfway through cooking time.
	PORK	MEDIUM	15 to 18	170°F (77°C)	
HAM (fully cooked)* Canned [3 Lb. (1.5 kg)] Butt [8 Lb. (4 kg)] Shank [8 Lb. (4 kg)] Slice, 1-inch (2.5 cm) thick [1Lb (500 g)]	—	MEDIUM	8 to 12	140°F (60°C)	Place ham fat-side up. Cover ham with plastic wrap, except slice.
		MEDIUM	13 to 15	140°F (60°C)	
		MEDIUM	13 to 15	140°F (60°C)	
		HIGH	5 to 8	—	
LAMB ROASTS [2½ to 4 lb. (1.2 to 2 kg)] Bone-in Medium Well Boneless Medium Well	—	MEDIUM	8½ to 13	140°F (60°C)	Place fat-side up. Cover with wax paper.
		MEDIUM	11 to 16	160°F (70°C)	
		MEDIUM	8 to 11	140°F (60°C)	
		MEDIUM	10 to 15	160°F (70°C)	

* The recommended maximum weight will vary according to the cavity size of your microwave oven model and the shape of meat.

Meats

Directions for Convenience Meats

Pierce sausage links with fork and score frankfurters before cooking.

Arrange food in a single layer in dish. Cover with wax paper to prevent spatter. Bacon may be placed on a microwave-safe dish. Cook according to time given in chart.

Let stand according to recommended time in chart.

Convenience Meats Chart

MEAT	AMOUNT	MANUAL POWER SETTING	APPROX. COOKING TIME (in minutes)	STAND TIME (in minutes)
Bacon, Slices	2 3 4	HIGH	1 to 2 2 to 2½ 2½ to 3	1
Canadian Bacon, Slices [1 oz. (30 g)]	2 4 6	MEDIUM-HIGH	½ to ¾ 1 to 2 3 to 4	1
Frankfurters, scored	2 4	HIGH	2 to 3 3 to 4	3
Ham, Slices [about 2 oz. (60 g) ea.]	2 4	HIGH	1½ to 2½ 2½ to 3½	2
Hamburgers, well [4 oz. (120 g) ea.]	1 2 4	HIGH	2 to 3 3 to 4 4½ to 5½	2
Lamb Chops, shoulder, ¾-inch (2 cm) thick	2 (about ½ lb.) 4 (about 1 lb.)	MEDIUM-HIGH	5½ to 7 10½ to 12	3
Pork Chops, rib or loin, ½-inch (1 cm) thick	2 (about ½ lb.) 4 (about 1 lb.)	MEDIUM-HIGH	4½ to 5½ 8 to 10	3
Sausage Links, frozen [precooked, brown and serve]	2 4 8	HIGH	1 to 2½ 1½ to 2½ 3 to 4	2
Sausage Links, fresh [2 to 3 oz. (60 to 90 g) ea.]	2 4 8	HIGH	4 to 6 6 to 8 8 to 10	3

Meats

CURRY LAMB

1 small onion, finely chopped
1/4 cup butter or margarine
3 tablespoons flour
1 pound boneless lamb, cut into 1 1/2-inch cubes
1 can (10 3/4 oz.) chicken broth
1/2 cup raisins
1/2 cup peanuts
3 tablespoons lemon juice
1 tablespoon curry powder
1/2 teaspoon ginger
1/2 teaspoon salt
1/2 cup flaked coconut
2 cups cooked rice (see page 34)

Yield: 4 Servings

Cook onion and butter in 2-quart casserole at **HIGH** 5 to 6 minutes; stir once. Stir in flour, lamb, broth, raisins, peanuts, lemon juice, curry powder, ginger and salt. Cover with lid. Cook at **HIGH** 5 minutes and at **MEDIUM-LOW** 20 to 25 minutes or until lamb is tender; stir twice. Sprinkle with coconut. Let stand, covered, 5 minutes. Serve over hot rice.

BEEF WITH BROCCOLI

1 tablespoon oil
1/4 pound boneless steak, cut into thin strips
1 clove garlic, finely chopped
1/4 teaspoon ginger
1 1/2 cups broccoli flowerets
1 tablespoon cornstarch
1/2 cup beef broth
1 tablespoon sherry
1 tablespoon soy sauce
Toasted sesame seeds (see page 39)

Yield: 4 Servings

Heat oil in 11 x 7-inch dish at **HIGH** 2 minutes. Stir in beef, garlic and ginger. Cook at **HIGH** 3 1/2 to 4 1/2 minutes. Stir twice. Stir in broccoli. Cover with plastic wrap. Cook at **HIGH** 3 to 5 minutes, or until broccoli is tender-crisp; stir once. Blend cornstarch with broth, sherry, and soy sauce until smooth. Stir into beef mixture. Cook at **HIGH** 3 to 4 minutes, or until sauce is thickened. Stir once. Top with sesame seeds.

VEAL CUTLETS CORDON BLEU

4 veal cutlets (about 1 lb.), pounded thin*
2 thin slices cooked ham, halved
2 thin slices Swiss cheese halved
1 cup seasoned dry bread crumbs
1/2 teaspoon salt
1/4 teaspoon pepper
Dash allspice
1 egg, beaten with 1/4 cup water
3 tablespoons oil

Yield: 4 Servings

On one side of each cutlet, place ham and cheese; fold cutlet in half. Pound edges together to seal or secure with wooden toothpicks. Dip cutlets in egg and then in bread crumbs mixed with salt, pepper and allspice. Coat bottom of 2 1/2-quart shallow oval casserole dish with half of oil; place cutlets in dish. Sprinkle remaining oil on cutlets.

Cook at **HIGH** 3 1/2 minutes. Turn cutlets over. Cook at **MEDIUM** 4 1/2 minutes. Let stand, covered with wax paper, 5 minutes before serving.

**Variation: Substitute chicken cutlets for veal.*

BASIC MEAT LOAF

1 1/2 pounds lean ground beef
1 cup soft bread crumbs
1/4 cup toasted wheat germ
1/2 cup milk
1 medium onion, chopped
2 eggs, slightly beaten
1 1/2 teaspoons salt
1/4 teaspoon pepper
1 can (8 oz.) tomato sauce, optional

Yield: 6 Servings

In a large bowl, stir all ingredients except tomato sauce until smooth. Pat mixture in oval shape into 11 x 7-inch dish.

TO COOK: Cook at **MEDIUM** 20 to 24 minutes.

TO COMPLETE: Let stand, covered, 5 minutes. Drain off excess juice. Invert meat loaf onto serving platter. If desired, spread tomato sauce over meat loaf.

Meats

APPLE-STUFFED PORK CHOPS

4 pork chops, 1-inch thick
1/4 cup butter or margarine, melted
1/2 cup chopped apple
1/2 cup herb-seasoned stuffing mix
1/4 cup (1 oz.) shredded Cheddar cheese
2 tablespoons chopped celery
1 tablespoon chopped onion
1 tablespoon chopped raisins
2 tablespoons orange juice
1/4 teaspoon Worcestershire sauce
1 tablespoon water

Yield: 4 Servings

Cut a horizontal slit in each pork chop to form pocket. In small mixing bowl, combine butter, apple, stuffing mix, cheese, celery, onion, raisins and orange juice; mix well. Fill each pocket with stuffing mix; secure opening with wooden toothpicks. Arrange pork chops in 11 x 7-inch dish. Mix Worcestershire with water and brush on pork chops.

TO COOK: Cook at **HIGH** 17 to 19 minutes.

TO COMPLETE: Let stand, covered, 5 minutes. Meanwhile, place remainder of stuffing in a small microwave-safe bowl. Cover with plastic wrap. Cook at **MEDIUM** 2 to 3 minutes, or until hot.

SPICY SAUSAGE STEW

1 pound Italian sausage links, cut into 1 1/2-inch pieces
1 pound boneless pork, cut into 1-inch cubes
1 can (28 oz.) whole tomatoes, chopped
1 can (8 oz.) tomato sauce
1 green pepper, cut into chunks
1 teaspoon basil
1 teaspoon oregano
1/2 teaspoon garlic powder

Yield: 6 Servings

In 3-quart casserole dish, heat sausage at **HIGH** 5 to 6 minutes; stir once. Drain. Stir in remaining ingredients. Cover with glass lid.

TO COOK BY SENSOR COOKING: Cook on **Stew**. After time appears in Display Window, stir occasionally.

TO COOK BY TIME: Heat at **HIGH** for 5 to 6 minutes then at **LOW** for 55 to 58 minutes, or until pork is tender. Stir occasionally.

TO COMPLETE: Skim off fat from liquid. Serve, if desired, with rice or pasta.

SWEET'N SOUR PORK

1 can (8 1/2 oz.) chunk pineapple in heavy syrup, drained; reserve 1/2 cup syrup
1/4 cup cider vinegar
1 tablespoon cornstarch
2 tablespoons oil
1 pound boneless pork, cut into 3/4 inch cubes
1/4 cup soy sauce
1 bunch green onions, thinly sliced (about 3 tbsp.)
1 green pepper, cut into small chunks

Yield: 4 Servings

In small glass bowl, combine reserved syrup, vinegar and cornstarch. Cook at **HIGH** 1 1/2 to 2 minutes, or until thickened; stir once.

Heat oil in 8-inch square dish at **HIGH** 2 minutes. Stir in pork, soy sauce and onion. Cook at **HIGH** 7 to 9 minutes; stir twice. Add green pepper and pineapple. Cook, covered with plastic wrap, at **HIGH** 4 to 5 minutes, or until pork is done. Stir in sauce and let stand, covered, 5 minutes before serving.

IRISH STEW

2 pounds boneless lamb, cut into 1-inch cubes
2 medium carrots, sliced into 1/4-inch pieces
2 potatoes (about 6 oz. ea.), peeled and cubed
2 1/2 cups water, divided
1 envelope (1 oz.) onion-mushroom soup mix
1 bay leaf
1/4 cup flour

Yield: 8 Servings

In 4-quart casserole dish, arrange lamb, carrots and potatoes forming three separate layers. In bowl, combine 2 cups hot water, onion-mushroom mix and bay leaf. Stir together until well blended. Pour mixture over potatoes. Cover with glass lid.

TO COOK BY SENSOR COOKING: Cook on **Stew**. After time appears in Display Window, stir twice.

TO COOK BY TIME: Heat at **HIGH** 7 to 8 minutes and at **LOW** 70 to 75 minutes. Stir twice.

TO COMPLETE: Blend flour with remaining 1/2 cup water. Stir into dish*. Heat at **HIGH** 4 to 5 minutes, or until stew is thickened.

*If desired, add 1/4 teaspoon browning sauce.

Poultry

Directions for Roasting Poultry

Season as desired, but salt only after cooking. Browning sauce mixed with equal parts of butter will enhance appearance.

Poultry may be stuffed or unstuffed. Tie legs together with cotton string. Whole chicken should be placed **breast-side down** on a microwave roasting rack set in an 8-to 10-inch square dish or 2½-quart shallow oval casserole dish.

Cover with wax paper to prevent spattering.

During cooking it may be necessary to shield legs, wings and breast bone to prevent overcooking. Wooden toothpicks can be used to hold foil in place.

If a large amount of juice accumulates in the bottom of the baking dish, occasionally drain it. If desired, reserve for making gravy.

To Cook Whole Poultry:

Multiply the weight of the poultry by the minimum recommended minutes per pound. Program Power and Time.

To Cook Chicken Parts:

Arrange pieces skin-side up, with meatier portions toward edge of dish. Cover with wax paper. Poultry is cooked when juices are clear. If there is a slight pink color in the juice, return poultry parts to the oven and cook one or two minutes longer.

Let stand, covered, 5 minutes before serving.

TO COOK BY SENSOR COOKING:

Arrange pieces skin-side up, whole poultry breast-side up, with meatier portions towards edge of dish. Cover completely with plastic wrap. Cook on Sensor Cooking Category.

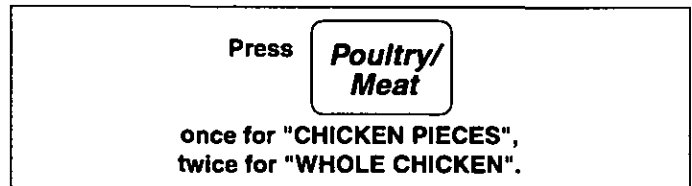

After Cooking, check the temperature of large chickens and turkeys with a meat thermometer. Check the temperature in both thigh muscles. If the thermometer touches bone, the reading may be inaccurate.

DO NOT use a conventional thermometer in the oven when cooking by microwave. Use only a microwave-safe thermometer.

Poultry Chart for Sensor & Time Cooking

POULTRY	SENSOR COOKING CATEGORY	POWER & TIME COOKING [time in min/lb. (450 g)]		TEMP. AFTER COOKING	SPECIAL INSTRUCTIONS
Cornish Hens, whole [1 to 1½ lb. (500 to 750 g) ea.]	—	HIGH	7 to 9	—	Place breast-side up.
Chicken parts	CHICKEN PIECES		7 to 8	—	Place skin-side up. Cover with plastic wrap
Chickens [up to 4 lb. (2kg)]	WHOLE CHICKEN	MEDIUM-HIGH	8½ to 11½	—	Place breast-side down. Turn breast-side up after half of cooking time. Cover with plastic wrap.
Chickens [4 to 6 lb. (2 to 3 kg)]			14 to 16	180°F–190°F (80°C–90°C)	
Turkey Breast [5 to 7 lb. (2.5 to 3.5 kg)]	—	MEDIUM	15 to 17	180°F–190°F (80°C–90°C)	Place breast-side up.
Duck [3 to 5 lb. (1.5 to 2.5 kg)]	—	MEDIUM-HIGH	8 to 10	180°F–190°F (80°C–90°C)	—
Turkey* [8 to 12 lb. (4 to 6 kg)]	—		12 to 14	180°F (80°C)	—

* The recommended maximum weight of turkey will vary according to the cavity size of your microwave oven model.

Poultry

CALIFORNIA CHICKEN

2 chicken breasts, split (1 $\frac{1}{4}$ to 2 lb.)
2 teaspoons lemon juice
1 teaspoon dried onion flakes
Basil
Pepper
 $\frac{2}{3}$ cup (3 $\frac{1}{2}$ oz.) shredded Cheddar cheese, divided
 $\frac{1}{2}$ small avocado, thinly sliced
4 thin slices tomato

Yield: 4 Servings

Arrange chicken in 8-inch square dish with meatier portions toward edge of dish. Sprinkle with lemon juice, onion flakes, basil and pepper.

TO COOK BY SENSOR COOKING: Cover completely with plastic wrap. Cook on **CHICKEN PIECES**.

TO COOK BY TIME: Cover completely with wax paper. Cook at **HIGH** 12 to 15 minutes, or until chicken is tender.

TO COMPLETE: Top chicken with $\frac{1}{3}$ cup cheese, avocado, tomato and remaining cheese. Cover with wax paper. Cook at **HIGH** 2 minutes. Let stand, covered, 5 minutes before serving.

STUFFED CORNISH HENS WITH ORANGE SAUCE

2 $\frac{1}{2}$ cups hot water
1 can (6 oz.) frozen orange juice concentrate, defrosted and divided
1 package (6 oz.) long grain and wild rice mix
4 slices bacon, cooked and crumbled
4 Cornish hens (1 lb. ea.)
 $\frac{1}{4}$ cup honey
 $\frac{1}{4}$ to $\frac{1}{2}$ teaspoon browning sauce

Yield: 4 Servings

In 2-quart casserole, combine water, $\frac{1}{4}$ cup orange juice concentrate and rice. Cover with lid. Cook at **HIGH** 8 minutes and at **MEDIUM-HIGH** 20 minutes, or until rice is tender; stir in bacon. Stuff hens with rice mixture; tie legs together with cotton string. Place hens in a 2 $\frac{1}{2}$ -quart shallow oval casserole dish. Cover with wax paper. Cook at **HIGH** 20 to 25 minutes, or until hens are tender. Meanwhile, combine remaining orange juice concentrate, honey and browning sauce; brush hens every 10 minutes. Let stand, covered, 10 minutes before serving. Cornish hens may be cut in half before serving, if desired.

CHICKEN PARMIGIANA

1 egg
 $\frac{1}{4}$ cup water
2 boneless chicken breasts, halved
1 cup seasoned dry bread crumbs
 $\frac{1}{2}$ cup grated Parmesan cheese
 $\frac{1}{4}$ teaspoon paprika
2 tablespoons oil
1 can (8 oz.) tomato sauce or 1 cup spaghetti sauce
Oregano
1 cup (4 oz.) shredded mozzarella cheese

Yield: 4 Servings

Beat egg with water. Dip chicken in bread crumbs mixed with Parmesan cheese and paprika, then in egg and again in bread crumb mixture. Coat bottom of 8-inch square dish with 1 tablespoon oil. Place chicken in dish; sprinkle with remaining oil. Cook at **HIGH** 3 to 4 minutes; turn chicken. Cook at **HIGH** 3 to 4 minutes. Top with tomato sauce, oregano and cheese.

Cover with wax paper. Cook at **HIGH** 12 to 14 minutes, or until sauce is hot. Sprinkle with mozzarella cheese and let stand, covered, 5 minutes, or until cheese is melted.

CHICKEN TERIYAKI

2 pounds chicken pieces
1 can (8 oz.) chunk pineapple in pineapple juice
1 clove garlic, finely chopped
 $\frac{1}{4}$ cup soy sauce
2 tablespoons packed brown sugar
 $\frac{1}{2}$ teaspoon salt
 $\frac{1}{4}$ teaspoon ginger

Yield: 4 Servings

Arrange chicken skin-side down in 2 $\frac{1}{2}$ -quart shallow oval casserole dish with meatier portions toward edge of dish. In small bowl, combine remaining ingredients; stir well. Pour sauce over chicken.

TO COOK BY SENSOR COOKING: Cover completely with plastic wrap. Cook on **CHICKEN PIECES**. After cooking, remove plastic wrap.

TO COOK BY TIME: Cover dish with wax paper. Cook at **HIGH** 8 minutes. Turn chicken skin-side up. Cook at **MEDIUM** 12 to 13 minutes.

TO COMPLETE: Chicken should be tender. Let stand, covered, 5 minutes. To serve, spoon pineapple sauce over chicken.

CHICKEN ENCHILADAS

1 large onion, chopped
1/2 cup chopped green pepper
2 cups finely chopped cooked chicken or turkey
1/2 cup chopped ripe olives
2 cans (10 oz. ea.) mild enchilada sauce, divided
1 1/2 cups (6 oz.) shredded Cheddar cheese, divided
8 corn tortillas
Shredded lettuce, optional
1/2 cup sour cream, optional

Yield: 4 Servings

In medium glass bowl, combine onion and green pepper. Cover with plastic wrap. Cook at **HIGH** 3 minutes; stir once. Stir in chicken, olives and 1/2 cup enchilada sauce. Cover with plastic wrap. Cook at **HIGH** 2 minutes, or until hot. Stir in 1/2 cup cheese. Let stand, covered. Arrange two tortillas side-by-side, on paper towel. Cover with another paper towel. Repeat with remaining tortillas, stacking one layer on top of the other. Heat at **HIGH** 1 minute. (This softens tortillas and makes them easier to roll.) Spoon about 1/3 cup chicken filling down center of each tortilla. Roll up tortilla and place seam-side down in 9 1/2-inch square dish. Pour remaining sauce over tortillas. Cover with wax paper. Cook at **HIGH** 9 to 10 minutes. Top enchiladas with remaining cheese. Cook at **HIGH** 3 minutes. Let stand 3 minutes before serving. Serve garnished with lettuce and sour cream.

VEGETABLE-STUFFED CHICKEN BREASTS

4 large boneless chicken breasts, skinned, split and pounded thin (about 2 lb.)
Salt
Pepper
1 cup frozen mixed broccoli, carrots and onions, defrosted, finely chopped
2 tablespoons butter or margarine
1/2 cup flour
1 egg, beaten with 2 tablespoons water
1 cup seasoned dry bread crumbs

Yield: 4 Servings

Season breasts with salt and pepper. Spoon 1/4 cup of vegetables onto each breast. Top with 1/2 tablespoon butter, then fold edges over to enclose the filling. Secure with toothpicks. Coat chicken breasts with flour, dip in egg, then in bread crumbs.

Arrange chicken in 8-inch square dish, cover with wax paper. Cook at **MEDIUM** 10 to 12 minutes, or until chicken is done.

MEXICAN CHICKEN

1 can (15 oz.) tomato sauce
2 to 3 tablespoons jalapeño peppers, finely chopped
2 tablespoons chopped onion
1/4 teaspoon chili powder
1/4 teaspoon cumin
1/4 teaspoon red pepper
2 ounces Monterey Jack cheese, shredded, optional
2 1/2 to 3 pounds chicken pieces, skinned

Yield: 4 Servings

In small bowl, combine tomato sauce, peppers, onion, chili powder, cumin and red pepper.

Arrange chicken skin-side up in 2 1/2-quart shallow oval casserole dish, with meatier portions toward edge of dish. Spread sauce evenly over chicken. Cover with wax paper. Cook at **HIGH** 5 1/2 to 6 minutes. Baste chicken with sauce.

Cook, uncovered, at **MEDIUM** 9 1/2 to 10 minutes, or until chicken is tender. Sprinkle with cheese. Let stand, covered, 5 minutes before serving.

CHICKEN CACCIATORE

2 1/2 to 3 pound chicken, cut into serving pieces
1 can (15 oz.) tomato sauce
1 jar (4 1/2 oz.) sliced mushrooms, drained
1/2 cup chopped onion
1 tablespoon sugar (optional)
1 teaspoon oregano
1 teaspoon salt
1 clove garlic, finely chopped
1/4 teaspoon pepper

Yield: 4 Servings

In 2-quart rectangular baking dish, arrange chicken, meatier portions toward edge of dish. In medium bowl, combine remaining ingredients, pour over chicken.

TO COOK BY SENSOR COOKING: Cover completely with plastic wrap. Cook on **STEW**. After time appears in Display Window, rearrange chicken; re-cover. After heating, remove plastic wrap.

TO COOK BY TIME: Cover with wax paper. Heat at **HIGH** 18 to 20 minutes. Rearrange chicken pieces once.

TO COMPLETE: Chicken should be tender. Let stand, covered, 7 minutes; if desired, serve with spaghetti.

Fish and Seafood

Directions for Preparing Fish and Seafood

Use fresh or defrosted clean fish. Arrange fish in a single layer in dish. For best results, avoid overlapping edges as this will prevent fish from cooking evenly.

Place thicker sections toward edge of the dish. (i.e., tail sections toward center).

Cover dish loosely, but completely with plastic wrap.

TO COOK BY SENSOR COOKING: Stir shrimp or scallops when time appears on the screen. Let stand, covered, 5 minutes.

TO COOK BY TIME: Arrange shrimp and scallops in single layer in dish. Cook on the recommended power level and minimum time in the chart. Rearrange or stir shrimp or scallops halfway through cooking.

Test for doneness before adding extra cooking time. The color of seafood and fish should be opaque and the fish should flake easily when tested with a fork. If undercooked, return to oven and cook 15 to 30 seconds longer at recommended power level.

After cooking, let stand, covered, 3 to 5 minutes before serving. Stand time allows the internal temperature to equalize throughout the food and thereby completes the cooking process.

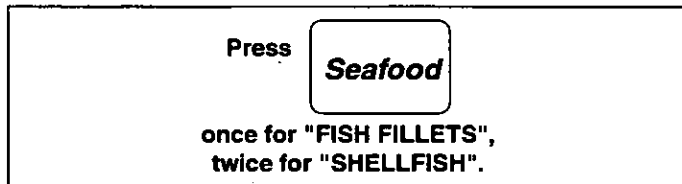

Fish and Seafood Chart for Sensor & Time Cooking

FISH OR SEAFOOD	SENSOR COOKING		TIME COOKING		
	AMOUNT	CATEGORY	AMOUNT	POWER	APPROX. COOKING TIME (in minutes)
Fish Fillets	½ to 2 lb. (250 g to 1 kg)	FISH FILLETS	1 lb. (500 g)	HIGH	5 to 7½
Fish Steaks [1-inch (2.5 cm) thick]	—	—	1 lb. (500 g)	MEDIUM-HIGH	5½ to 7
Scallops (sea)	½ to 2 lb. (250 g to 1 kg)	SHELLFISH	1 lb. (500 g)	MEDIUM-HIGH	5 to 6
Shrimp, medium size (shelled and cleaned)	½ to 2 lb. (250 g to 1 kg)	SHELLFISH	1 lb. (500 g)	MEDIUM-HIGH	5 to 6
Whole fish, cleaned (stuffed or unstuffed)	—	—	1 to 1½ lb. (500 g–750 g)	HIGH	5 to 7

TARRAGON HALIBUT STEAKS

- 3 tablespoons lemon juice
- 2 tablespoons oil
- 1 teaspoon salt
- ½ teaspoon paprika
- ½ teaspoon onion powder
- ½ teaspoon tarragon
- 4 halibut steaks, 1-inch thick (about 8 oz. ea.)

Yield: 4 Servings

In small bowl, mix lemon juice, oil, salt, paprika, onion powder and tarragon until blended. Arrange halibut steaks in 2½-quart shallow oval casserole dish. Pour marinade over steaks. Cover and marinate 1 hour. Cook at **HIGH** 7 to 9 minutes, or until fish flakes easily. Let stand, covered, 3 minutes before serving.

FILLET ALMANDINE

- 3 tablespoons butter or margarine
- 3 tablespoons slivered almonds
- ½ pound fish fillets
- Salt and pepper to taste
- 2 teaspoons lemon juice
- 2 teaspoons parsley

Yield: 2 Servings

Place butter and almonds in 8-inch square dish. Cook at **HIGH** 3 to 4 minutes; stir once. Cover fillets with butter. Sprinkle with lemon juice. Cover with plastic wrap. Cook at **HIGH** 4 to 5 minutes, or until fish flakes when tested with a fork. Let stand, covered for 3 minutes. Before serving, season with salt and pepper and sprinkle with parsley.

Fish and Seafood

MARYLAND CRAB BAKE

1 cup each chopped celery, green pepper and onion
3 tablespoons butter or margarine
2 packages (6 oz. ea.) crabmeat, drained and flaked,
canned or frozen, defrosted (see page 12)
1 teaspoon Worcestershire sauce
½ teaspoon pepper
½ teaspoon salt
½ cup buttery cracker crumbs
1 tablespoon butter or margarine, melted
Dash paprika

Yield: 4 to 6 Servings

In 2-quart casserole, combine celery, green pepper, onion and 3 tablespoons butter. Cover with lid. Cook at **HIGH** 3 to 4 minutes, or until vegetables are tender; stir once. Stir in crab, Worcestershire, pepper and salt. Combine cracker crumbs, melted butter and paprika; sprinkle over casserole.

Cook at **MEDIUM-HIGH** 6 to 7 minutes, or until heated through. Stir twice. Let stand 5 minutes before serving.

SCALLOPS WITH HERB LEMON BUTTER

¼ cup butter or margarine
½ teaspoon basil
½ teaspoon crushed rosemary
¼ teaspoon salt
1 pound sea scallops
Juice from 1 lemon (about 2 tablespoons)
Paprika

Yield: 4 Servings

TO COOK BY SENSOR COOKING: In 8-inch square dish, combine all of the above ingredients except paprika. Cover with plastic wrap. Cook on **SHELLFISH**. After time appears on the screen, stir scallops, re-cover and continue cooking.

TO COOK BY TIME: In 8-inch square dish, combine butter, basil, rosemary and salt. Cook at **HIGH** 1½ minutes, or until melted. Stir in scallops and sprinkle with lemon juice; spoon butter mixture over scallops. Cover with plastic wrap. Cook at **MEDIUM-HIGH** 6½ to 8½ minutes.

TO COMPLETE: Scallops should be tender. Sprinkle with paprika; let stand, covered, 5 minutes before serving.

BAKED STUFFED CLAMS

18 small (littleneck) clams, scrubbed and opened
½ to ⅔ cup seasoned dry bread crumbs
2½ to 3 tablespoons oil
¼ teaspoon garlic powder
¼ teaspoon paprika
¼ teaspoon pepper
3 slices bacon, crisp-cooked and crumbled
(see page 22)

Yield: 18 Clams

Arrange clams on the half shell in two 8-inch square dishes. Pierce each clam several times with toothpick. Combine bread crumbs, oil, garlic, paprika and pepper. Sprinkle crumbs on clams. Top with bacon.

Cook on **MEDIUM-HIGH** 2 to 3 minutes, or until clams are tender.

COQUILLE ST. JACQUES

2 tablespoons butter or margarine
1 small onion, finely chopped
2 tablespoons flour
Dash white pepper
¼ cup milk or half'n half
1 jar (2½ oz.) sliced mushrooms, drained
½ cup (1½ oz.) shredded Swiss cheese
1 pound sea scallops
¼ cup white wine
¼ cup buttered bread crumbs
Parsley flakes

Yield: 4 Servings

Place butter and onions in medium glass bowl. Cook at **MEDIUM-HIGH** ¾ to 1 minute; stir in flour and pepper. Gradually add milk, stirring until smooth. Cook at **MEDIUM-HIGH** for 3 to 3½ minutes or until thickened; stir twice. Stir in mushrooms, cheese, scallops and wine. Spoon mixture into 2½-quart shallow oval casserole dish. Top with bread crumbs and parsley. Place dish on rack. Cook at **MEDIUM-HIGH** 5 to 6 minutes.

Casseroles

Directions for Preparing Casseroles

Prepare casseroles and stews according to recipe directions. Stew meats are not browned before cooking. Omit any oil or fat and flour used for browning. Fresh and firm vegetables such as potatoes, carrots, rutabagas and beans are added at the beginning of cooking. Frozen vegetables and fresh vegetables with soft texture such as zucchini, tomatoes or mushrooms are added during the last 30 minutes of cooking. Defrosted frozen vegetables are added with the thickener. Place covered microwave-safe dish in oven.

EASY LASAGNA

1/2 pound ground beef
1 jar (30 oz.) spaghetti sauce
1/2 cup water
1 container (15 oz.) ricotta or cottage cheese
1 egg, slightly beaten
1/2 teaspoon salt
1 teaspoon pepper
9 lasagna noodles (cooked)
1/2 pound mozzarella cheese thinly sliced
1/2 cup grated Parmesan cheese

Yield: 6 Servings

In large glass bowl, crumble ground beef. Heat at **HIGH** 1 1/2 to 2 1/2 minutes, or until beef is browned; stir once. Drain. Stir in spaghetti sauce and water. Heat at **HIGH** 3 1/2 to 4 1/2 minutes or until bubbly. Meanwhile, combine ricotta cheese, egg, salt and pepper. In rectangular baking dish, spoon 1/2 cup sauce; alternately layer noodles, ricotta cheese mixture, mozzarella cheese and sauce, forming 3 layers.

TO COOK BY SENSOR COOKING: Cover dish with plastic wrap. Cook on **CASSEROLE**. After time appears in Display Window, shield ends of dish with foil.

TO COOK BY TIME: Cook, covered with plastic wrap, at **HIGH** 8 minutes and at **MEDIUM-LOW** 35 to 38 minutes, or until noodles are tender. If necessary, shield ends of dish with foil, during the last 10 minutes of cooking time.

TO COMPLETE: Sprinkle with Parmesan cheese; let stand, covered, 5 minutes before serving.

TO COOK BY SENSOR COOKING:

Combine ingredients. Cover dish. Select Sensor Category "**Casserole**" and press **Start** Pad.

TO COOK BY TIME:

Prepare casseroles or stew by microwaving at lower power levels. **MEDIUM** and **MEDIUM-LOW** power levels allow flavors to blend and less tender cuts of meat to become tender. Use our recipes as a guideline for adapting your favorite recipes.

BAKED ZITI

1 package (8 oz.) ziti macaroni, cooked (see page 34)
1 jar (15 1/2 oz.) spaghetti sauce
1/2 cup (2 oz.) shredded mozzarella cheese

Yield: 4 Servings

Combine ziti and spaghetti sauce in 2-quart casserole. Cover with lid.

TO COOK BY SENSOR COOKING: Cook on **CASSEROLE**. After time appears in Display Window, stir occasionally.

TO COOK BY TIME: Cook at **HIGH** 7 to 9 minutes; stir twice.

TO COMPLETE: Sprinkle with cheese. Let stand, covered, 10 minutes before serving.

MACARONI AND CHEESE

1 package (8 oz.) elbow macaroni, cooked and drained (see page 34)
3/4 pound pasteurized process cheese spread, cut into cubes
3/4 to 1 cup milk
1/2 to 3/4 teaspoon salt
1/4 teaspoon onion powder
1/4 teaspoon pepper
1/4 teaspoon dry mustard, optional
Buttered bread crumbs

Yield: 4 Servings

In 3-quart casserole, combine macaroni, cheese, milk, salt, onion, pepper and mustard. Cover with lid.

TO COOK BY SENSOR COOKING: Cook on **CASSEROLE**. After time appears in Display Window, stir occasionally.

TO COOK BY TIME: Cook at **MEDIUM-HIGH** 12 to 15 minutes; stir twice.

TO COMPLETE: Top with bread crumbs. Cook, uncovered, at **MEDIUM-HIGH** 3 minutes. Let stand, covered, 10 minutes before serving.

Eggs and Cheese

SCRAMBLED EGGS

Beat eggs, 1 tablespoon milk and dash of salt for each egg. Pour into greased glass container. Cook at **MEDIUM-HIGH** according to time in the chart. Stir two-thirds of the way through the cooking time. Stir and let stand. Eggs will continue to cook during stand time and should be slightly undercooked after cooking.

Eggs	Container	Cooking Time (in min.)	Stand Time (in min.)
1	1-cup glass measure	¾ - 1¼	1
2	1-cup glass measure	1½ - 2	1½
4	1-quart bowl	3¼ - 3¾	1½
6	1½-quart bowl	4¾ - 5½	2

POACHED EGGS

Place 1½ cups hot water and a dash of vinegar and salt in 2-quart casserole and heat at **HIGH** 5 to 7 minutes, or until water boils. Break egg(s) into boiling water and with toothpick pierce egg yolk twice and egg white several times. Cook at **MEDIUM-HIGH** according to the time given in the chart. Let stand. Eggs will continue to cook during stand time and should be slightly undercooked after cooking.

Eggs	Cooking Time (in minutes)	Stand Time (in minutes)
1	½ - ¾	1
2	1 - 1¼	2
4	1¾ - 2	2

Eggs cannot be hard-cooked in their shells in a microwave oven. Pressure will build up and the egg will explode.

SPINACH CHEESE RING

2 packages (10 oz. ea.) frozen chopped spinach, cooked and drained
 1 cup (½ pint) cottage cheese
 2 eggs
 ½ cup heavy cream
 2 tablespoons melted butter
 ¼ cup finely chopped green onions
 ¼ cup plain dry bread crumbs
 3 tablespoons grated Parmesan cheese
 ¼ teaspoon paprika
 ¼ teaspoon dill weed
 Dash pepper

Yield: 4 Servings

In medium bowl, combine all ingredients; mix well. Spoon into well greased 1-quart glass ring mold. Cover with plastic wrap. Cook at **MEDIUM-HIGH** 8 to 12 minutes, or until almost set. Let stand, uncovered, 5 minutes.

BASIC OMELET

1 tablespoon butter or margarine
 2 eggs
 2 tablespoons milk
 ¼ teaspoon salt
 Dash pepper

Yield: 1 Serving

Melt butter in 9-inch pie plate at **HIGH** 1 minute; turn plate to coat bottom with butter. Combine remaining ingredients, pour into pie plate. Cook, covered with plastic wrap, at **MEDIUM-HIGH** 2 to 3½ minutes, or until omelet is almost set; stir after 1 minute. Let stand, covered, 2 minutes. Loosen edges of omelet from plate with spatula; fold into thirds to serve.

Variations: Try one of these easy variations:

For CHEESE Omelet, before folding, sprinkle ¼ cup shredded cheese down center of omelet.

For HAM Omelet, before folding, sprinkle ¼ cup finely chopped cooked ham down center of omelet.

For HERB Omelet, blend ½ teaspoon basil, thyme or crushed rosemary with eggs and milk.

For JELLY Omelet, before folding, spoon ¼ cup jelly down center of omelet.

CAULIFLOWER AND CARROT QUICHE

1½ cups coarsely chopped cauliflower
 1 carrot, shredded
 1 tablespoon water
 9-inch pie shell, baked (see page 38)
 1 cup (4 oz.) shredded Swiss cheese
 ¼ cup grated Parmesan cheese
 3 eggs
 1 cup (½ pt.) heavy cream
 ¼ teaspoon pepper

Yield: 10 Servings

In 1-quart bowl, combine cauliflower, carrot and water. Cover with plastic wrap. Cook at **HIGH** 5 to 6 minutes. Stir once. Sprinkle vegetables into pie shell. Sprinkle cheeses over vegetables. Pour cream into 2-cup measure. Cook at **MEDIUM-HIGH** 2 to 2¼ minutes. Meanwhile, beat eggs in small bowl. Stir a little hot cream into eggs. Blend eggs back into cream. Add pepper. Pour mixture over ingredients in pie shell.

Cook at **MEDIUM** 10 to 12 minutes.

Vegetables

To Cook Fresh Vegetables

Weights given in the chart are purchase weights before peeling, trimming, etc. Prepare vegetables for cooking; cut slice or trim as directed in chart. Cook vegetables in covered casserole, except for whole, unpeeled vegetables.

Whole, unpeeled vegetables, such as potatoes or eggplant, should be pierced before cooking and arranged on microwave-safe dish in the oven. Arrange potatoes in a circular pattern on dish.

TO COOK BY TIME: Cook according to the time recommended in the chart. Two-thirds of the way through cooking, stir, rearrange, and/or turn vegetables over.

TO COOK BY SENSOR COOKING: When time appears on the screen, stir vegetables.

Press **Potato/
Vegetables**

once for "POTATO",
twice for "FRESH VEGETABLES".

After cooking, stir vegetables. Let stand, covered, before serving. Vegetables that are cut into pieces should stand 3 minutes. Whole vegetables should stand 5 minutes.

To Cook Frozen Vegetables

TO COOK BY SENSOR COOKING:

Empty 10-28 oz. package of frozen vegetables into glass container. Add 2 tablespoons water. Cover dish with lid, or loosely but completely, with plastic wrap. Cook on **Frozen Vegetables**.

For frozen vegetables in the pouch, pierce a hole in the pouch, place on a dish and cook on **Frozen Vegetables**. After cooking, stir and let stand, covered, 3 minutes before serving. **DO NOT** cook frozen vegetables which contain any type of butter or sauce by Sensor Cooking Pad.

Press **Potato/
Vegetables**

three times for "FROZEN VEGETABLES".

Never leave oven unattended when heating small amounts of foods such as one or two potatoes. Potatoes may catch fire if overcooked and cause severe damage to the oven and surroundings.

Fresh Vegetable Chart for Sensor & Time Cooking

VEGETABLE	AMOUNT	WATER	SENSOR COOKING CATEGORY	APPROX. COOKING TIME at HIGH Power (In minutes)
Artichokes , 6 to 8 oz. ea.	1	2 tablespoons	FRESH VEG.	6 to 7
	2	¼ cup		9 to 11
	4	¼ cup		14 to 16
Asparagus , 6-in spears	1 lb. (500 g)	2 tablespoons		7 to 8
Beans , green/wax, cut into 1½-in. pieces	1 lb. (500 g)	¼ cup		7 to 9
Broccoli , cut into spears	1 lb. (500 g)	¼ cup		7 to 10
Brussels Sprouts	1 tub [10 oz. (300 g)]	2 tablespoons		7 to 9
Cabbage , shredded	1 lb. (500 g)	¼ cup		7 to 9
Carrots , sliced ½-in. thick	1 lb. (500 g)	¼ cup		7 to 9
Corn , fresh on the Cob	1 ear	2 tablespoons	—	6 to 7
	2 ears	2 tablespoons		7 to 9
	4 ears	¼ cup		12 to 14
Eggplant , fresh cubed Whole (pierce skin several times)	1 lb. (500 g)	¼ cup	FRESH VEG.	7 to 8½
	1 to 1¼ lb. (500 to 600 g)	—		4½ to 7
Onions , small whole	8 to 10 [1 lb. (500 g)]	¼ cup	—	6½ to 7½
Peas , green, shelled	2 lb. (1kg)	¼ cup	FRESH VEG.	6 to 8
Potatoes , 8 to 9 oz. ea. Cook uncovered, turn over halfway through cooking time. Pierce skin several times before cooking.	1	—	POTATO	5 to 7
	2	—		8 to 10
	4	—		13 to 15½
Spinach , leaf	1 lb. (500 g)	2 tablespoons	—	5½ to 7
Squash, Summer , sliced ½-in. thick	1 lb. (500 g)	2 tablespoons	FRESH VEG.	6 to 8
Squash, Winter , Cut in half, scoop out seeds, place cut-side down.	1 lb. (500 g)	¼ cup	—	6½ to 7½

Vegetables

SCALLOPED POTATOES

¼ cup butter or margarine
1 tablespoon dried onion flakes
1 teaspoon salt
¼ teaspoon pepper
¼ cup flour
2 cups milk
6 medium potatoes (about 6 oz. ea.), peeled and thinly sliced

Yield: 6 Servings

In 4-cup glass measure, combine butter, onion, salt and pepper. Cook at **HIGH** 1 to 1½ minutes, or until butter is melted. Stir in flour, gradually add milk, stirring until smooth. Cook at **MEDIUM-HIGH** 8 to 9 minutes, or until sauce is thickened; stir twice. In 2-quart casserole, alternately layer potatoes and sauce, forming three layers.

Cover with lid. Cook at **MEDIUM-HIGH** 27 minutes or until potatoes are tender. Let stand, covered, 5 minutes before serving.

SWISS SCALLOPED CORN

3 slices bacon, crisp-cooked and crumbled
2 cans (17 oz. ea.) whole kernel corn, drained
1 cup (4 oz.) shredded Swiss cheese
1 egg
1 can (5½ oz.) evaporated milk
½ teaspoon onion powder
¼ teaspoon pepper
1½ tablespoons flour
¼ cup dry bread crumbs
1 tablespoon butter or margarine, melted
Paprika

Yield: 6 Servings

In 2½-quart shallow oval casserole dish, combine bacon, corn and cheese. Blend in egg, milk, onion powder, pepper and flour.

Cook at **HIGH** 5 to 6 minutes; stir once. Combine bread crumbs, butter and paprika. Sprinkle over corn. Cover with plastic wrap. Cook at **HIGH** 4 to 5 minutes. Let stand, covered, 5 minutes before serving.

BAKED STUFFED POTATOES

4 medium potatoes, baked (see page 32)
½ cup (2 oz.) shredded Cheddar cheese
⅓ to ½ cup milk
2 tablespoons butter or margarine, softened (see page 39)
1 egg
Salt and pepper to taste
Paprika

Yield: 4 Servings

Cut a thin slice (lengthwise) from each potato. Scoop out potato, leaving a thin shell. In small bowl, combine potato, cheese, milk, butter, egg, salt and pepper; mash until smooth. Spoon potato mixture into shell; sprinkle with paprika. In 2½-quart shallow oval casserole dish, arrange potatoes in a circle.

TO COOK BY SENSOR COOKING: Cover loosely, but completely with plastic wrap. Cook on **POTATO**.

TO COOK BY TIME: Cover with wax paper. Cook at **MEDIUM-HIGH** 4 to 6 minutes.

TO COMPLETE: Let stand, uncovered, 3 minutes before serving.

RATATOUILLE

2 medium onions, sliced
1 medium green pepper, cut into ½-inch slices
⅓ cup oil
2 cloves garlic, finely chopped
1 medium eggplant (about 1½ lb.), peeled and cut into ¾-inch pieces
3 medium tomatoes, cut into eighths
2 medium zucchini (about 1 lb.), cut into ½-inch slices
¼ cup vegetable juice cocktail or tomato juice
2 teaspoons each basil and parsley flakes
1 teaspoon salt
¼ teaspoons pepper

Yield: 6 Servings

In 3-quart casserole, combine onions, green pepper, oil and garlic. Cover with lid. Cook at **HIGH** 4 to 5 minutes; stir once. Stir in remaining ingredients; cover.

TO COOK BY SENSOR COOKING: Cook on **FRESH VEGETABLES**. When time appears on the screen, stir twice.

TO COOK BY TIME: Cook at **HIGH** 18 to 20 minutes; stir twice.

TO COMPLETE: Let stand, covered, 5 minutes before serving.

Pasta, Rice and Cereal

ITEM	CONTAINER	AMOUNT OF HOT WATER	POWER	APPROX. COOKING TIME (in min.)	STAND TIME (in min.)	SPECIAL INSTRUCTIONS
PASTA Egg Noodles medium width (8 oz.)	3-qt. casserole	1½ quarts	HIGH	7 - 9	3	Add 1 teaspoon oil and 1 teaspoon salt to water. Cover and bring hot water to boil at HIGH (approx. 13 - 18 minutes). Stir in pasta. Cook, covered; stirring occasionally. Let stand, covered. Pasta that is to be added to a casserole should be slightly undercooked.
Specialty Noodle (8 oz.)	3-qt. casserole	1½ quarts	HIGH	8 - 12	3	
Spaghetti or Fusilli (8 oz. broken)	3-qt. casserole	2 quarts	HIGH	12 - 14	3	
Frozen Tortellini (16 oz.)	3-qt. casserole	1½ quarts	HIGH	7 - 9	3	
RICE Flavored Rice Mix (4.4 to 7.5 oz.)	2-qt. casserole	as pkg. directs	MEDIUM	15 - 30 or as pkg. directs	10	Cover & heat hot water to a boil at HIGH (approx. 4 - 7 min.). Add rice, salt & butter (amount of salt & butter as package directs). Cook covered; stir. Let stand, covered.
Long Grain (1 cup)	2-qt. casserole	2 cups	MEDIUM -LOW	13 - 16	10	
Short Grain (1 cup)	2-qt. casserole	2 cups	MEDIUM -LOW	10 - 12	10	
CEREAL Cream of Wheat (Reg.) 1 serving (2½ tbsp.)	1-qt. glass bowl	¾ cup	HIGH	2 - 4	1	Stir cereal into water. Stir frequently. Cook uncovered. Stir once before stand time.
2 servings (½ cup)	1½-qt. glass bowl	1½ cups	HIGH	3 - 5	1	
Farina 1 serving (3 tbsp.)	1-qt. glass bowl	1 cup	HIGH	2 - 3	1	Cover and heat hot water to a boil at HIGH (approx. 3 to 6 min.) Slowly add cereal; stirring frequently. Cook uncovered. Stir once before stand time.
2 servings (6 tbsp.)	1½-qt. glass bowl	2 cups	HIGH	2 - 4	1	
Oatmeal (Quick) 1 serving (½ cup)	individual serving dish	½ cup	HIGH	1 - 2	1	Combine water and cereal. Cook uncovered. Stir once before stand time.
2 servings (¾ cup)	2 individual serving dishes	1½ cups	HIGH	3 - 4	1	
4 servings (1½ cups)	2-qt. glass bowl	3 cups	HIGH	5 - 6	2	
Wheat Bran Cereal 1 serving (¼ cup)	1-qt. glass bowl	¾ cup	HIGH	3 - 4	1	
2 servings (½ cup)	1½-qt. glass bowl	1½ cups	HIGH	6 - 7½	1	
4 servings (1 cup)	2-qt. glass bowl	3 cups	HIGH	7 - 8	2	

To prepare Instant Rice: Combine 1 cup water, 1 teaspoon butter and dash salt in 1-quart casserole. Cover with lid. Cook at **HIGH** 2 to 3 minutes or until water boils. Stir in 1 cup rice. Let stand, covered, 5 minutes. Fluff lightly with fork before serving.

Pasta, Rice and Cereal

NOODLE PUDDING

1 package (8 oz.) medium egg noodles
½ cup butter or margarine
4 eggs, beaten
1 cup cottage cheese
1 cup sour cream
¾ cup raisins
½ cup sugar
1 teaspoon cinnamon
¼ teaspoon nutmeg

Yield: 8 Servings

Cook noodles according to chart on page 34. Heat butter in large glass bowl at **MEDIUM-HIGH** 1 minute, or until melted. Combine remaining ingredients and drained noodles; pour into 2-quart ring mold. Sprinkle, if desired, with additional cinnamon. Cook at **MEDIUM-HIGH** 18 to 20 minutes, or until pudding is set. Let stand, covered with wax paper. Serve warm or chilled.

GRANOLA CEREAL

2 cups quick or old fashioned oats
½ cup slivered almonds or chopped nuts
½ cup wheat germ
½ cup flaked coconut
¼ cup raisins (presoaked in ¼ cup hot water and drained)
1 tablespoon packed brown sugar
3 tablespoons vegetable oil
3 tablespoons honey
1 tablespoon butter
1 teaspoon vanilla

Yield: 3 cups

In 11 x 7-inch dish, combine oats, almonds, wheat germ, coconut, raisins and brown sugar; mix well. Set aside. In a 1-cup glass measuring cup combine oil, honey and butter. Cook at **HIGH** ½ to 1 minute or until butter is melted. Cool 5 minutes. Stir in vanilla and pour over oats. Blend thoroughly. Cook on **HIGH** 7 to 9 minutes, stirring occasionally. Cool. Store in airtight container.

PASTA PRIMAVERA

1 package (8 oz.), rotelle pasta or spaghetti, broken
2 cups broccoli flowerets
2 cups cauliflower
3 carrots, cut into sticks
2 cloves garlic, finely chopped
¼ cup chopped fresh parsley
2 tablespoons oil
1 teaspoon basil
3 tablespoon butter or margarine
½ cup grated Parmesan cheese
Pepper to taste

Yield: 4 Servings

TO COOK BY SENSOR COOKING: Cook pasta according to chart on page 33. In 3-quart casserole, combine broccoli, cauliflower, carrots, garlic, parsley, oil, basil and butter. Cook covered on **PASTA**. Add Parmesan cheese. Season with pepper.

TO COOK BY TIME: Cook pasta according to chart on page 33. In 3-quart casserole, combine broccoli, cauliflower, carrots, garlic, parsley, oil, and basil. Cover with lid. Cook at **HIGH** 7 to 9 minutes. Let stand, covered, 3 minutes. Meanwhile, in medium glass bowl, heat butter at **HIGH** 1 to 1½ minutes, or until melted; stir in drained pasta. Add vegetables and cheese; toss well. Season with pepper.

PEPPERED SESAME NOODLES

8 ounces vermicelli
3 tablespoons sesame oil
2 tablespoons peanut oil
6 to 8 fresh chili or jalapeño peppers, sliced, seeds removed, if desired
3 tablespoons Worcestershire sauce
2 tablespoons soy sauce
4 to 5 green onions, cut diagonally into ½-inch pieces.
2 tablespoons sesame seeds, toasted

Yield: 6 to 8 Servings

Cook vermicelli according to chart on page 34. Drain, rinse and set aside. In 2-cup glass measure blend sesame and peanut oils. Cook at **HIGH** 1 minute. Add chili peppers. Cook at **HIGH** 15 seconds. Add Worcestershire sauce and soy sauce. Pour over cooked vermicelli. Toss to coat. Cook at **HIGH** 3 minutes. Add green onions and sesame seeds. Mix well.

Quick Breads and Cakes

Layer cakes must be baked **one layer at a time**, or the entire cake mix may be baked in a 16-cup fluted tube dish. Prepare batter according to package, chart or recipe directions.

Use dishes recommended in chart or in recipes. Glass dishes allow the bottom of the cakes to be checked for doneness. When the product is removed from the oven, visually check bottom.

If cake is to be inverted or removed from dish, such as layer cakes or upside-down cake, grease sides of dish and line bottom of 8" or 9" round or square dish with wax paper.

If cake is to be served directly from the dish, grease bottom of dish. Never flour cake dishes, fluted tube dishes or muffin pans.

Cook second layer of 8" or 9" round or square cake immediately after the first. The remaining batter can be used for cupcakes.

Check during cooking. Different brands vary in ingredients and density of batter; cooking times may be slightly different than those given in chart.

After cooking:

Test for doneness. Check to make sure edges of cake are dry and have begun to pull away from sides of dish, and toothpick inserted near center comes out clean.

Let stand, uncovered, on a flat surface for 10 to 15 minutes. Stand time is important to allow cakes and cupcakes to finish baking. Cakes and breads that are to be inverted should be loosened from the sides of the dish. Carefully turn out of dish. Remove wax paper from bottom of cake. Store, covered, until ready to serve.

For best results, it is recommended to follow microwave cooking instructions issued by the individual cake mix manufacturers.

ITEM	AMOUNT OF BATTER	PREPARATION/ DISH SIZE	FIRST STAGE	SECOND STAGE	SPECIAL INSTRUCTIONS	STAND TIME
Quick Bread (14 to 17 oz.)	All batter	Line bottom of 8½" x 4½" x 2½" loaf dish with wax paper.	MEDIUM-LOW 8 - 9 min.	HIGH 4½ - 5½ min.	Shield each end with a 3" strip of foil. Mold foil around handle.	15 min. uncovered
Cornbread (7 or 8 oz.)	All batter	Grease 8" or 9" round or square dish.	MEDIUM-HIGH 4½ - 6 min.	—	Cover with wax paper.	10 min. uncovered
Gingerbread (14 oz.)	All batter	8" square dish	HIGH 10 - 12 min.	—	Shield each corner with a piece of foil. Place dish on a microwave-safe inverted pie plate.	15 min. uncovered
Muffins (Cook 6 at a time)	Fill ½ full	6-cup muffin pan lined with paper baking cups	MEDIUM 3½ - 5 min.	—	—	5 min. uncovered
Cake Mix (18 to 20¼ oz.)	2¼ cups	Wax paper-lined 8" or 9" round or square glass baking dish	MEDIUM-LOW 8 min.	HIGH 3 - 4½ min.	Place dish on microwave-safe inverted pie plate. Cover with wax paper.	10 min. uncovered
Cake Mix (18 to 20¼ oz.)	Prepare batter according to package directions. Pour all batter into pan.	Generously grease 16-cup fluted tube pan	MEDIUM-LOW 9 - 10 min.	HIGH 6 - 11 min.	Cover pan with wax paper.	—
Cupcakes	Fill ½ full	Line microwave muffin pan with paper baking cups. 2 4 6	MEDIUM (in minutes) 1¼ - 2 2 - 2½ 3½ - 4½	—	Cover with wax paper.	5 min. uncovered

Quick Breads and Cakes

SOUR CREAM COFFEE CAKE

½ cup sugar
¼ cup butter
1½ cups flour
1 cup sour cream
2 eggs
1½ teaspoons vanilla extract
1 teaspoon baking powder
1 teaspoon baking soda
½ teaspoon salt

Topping:

½ cup chopped walnuts
¼ cup sugar
½ teaspoon cinnamon

Yield: 8 Servings

In large bowl, cream sugar and butter. Add remaining ingredients and beat with electric mixer at low speed for 30 seconds and then medium speed for 2 minutes. Pour into greased 8-inch square baking dish. In separate bowl, combine topping ingredients; sprinkle over batter.

TO COOK: Cover with wax paper. Elevate dish on inverted glass pie plate. Cook at **MEDIUM-HIGH** 5½ minutes and at **MEDIUM** 5 to 5½ minutes, or until edges are dry and toothpick inserted near center comes out clean.

TO COMPLETE: Let stand, uncovered for 10 minutes. Serve immediately.

CHERRY BRUNCH ROLLS

½ cup packed brown sugar
½ cup chopped maraschino cherries
¼ cup flaked coconut
1 tablespoon water
¼ teaspoon cinnamon
1 can (7.5 oz.) refrigerated biscuits
3 tablespoons butter or margarine, melted

Yield: 10 rolls

In small glass bowl, combine brown sugar, cherries, coconut, water and cinnamon; stir. Cook at **HIGH** 2 to 2½ minutes until boiling. Pour into a greased 5-cup ring mold. Dip each biscuit into melted butter; arrange on top of cherries. Cook at **MEDIUM-HIGH** 6 to 8 minutes.

Cook at **MEDIUM-HIGH** 3 to 4 minutes. Let stand, covered for 5 minutes. Invert onto serving plate. Store covered.

BANANA NUT COFFEE CAKE

¼ cup oil
¼ cup milk
1 egg
1 mashed ripe banana
½ cup packed brown sugar
¾ cup flour
½ cup chopped nuts
¾ teaspoon baking powder
¼ teaspoon salt
¼ teaspoon baking soda

Nut Topping:

¼ cup packed brown sugar
¼ cup chopped nuts
2 tablespoons flour
¼ teaspoon cinnamon
1 tablespoon butter or margarine, softened

Yield: 8 Servings

In medium bowl, combine oil, milk, egg, banana, and sugar. Add flour, nuts, baking powder, salt and baking soda; stir just until flour is moistened. Pour into greased 8- or 9-inch round dish. In small bowl, prepare Nut Topping. Combine brown sugar, nuts, flour, and cinnamon; cut in butter. Sprinkle over batter.

TO COOK: Cover with wax paper. Cook on **MEDIUM-HIGH** 5½ to 6 minutes. Cook at **MEDIUM** 5½ to 6 minutes, or until toothpick inserted near center comes out clean.

TO COMPLETE: Let stand, uncovered, 10 minutes. Store, covered, until ready to serve.

SOUTHERN CHEESE SPOON BREAD

½ cup yellow cornmeal
2 cups milk
½ teaspoon salt
2 eggs, beaten
1 cup (4 oz.) diced American cheese
2 tablespoons butter or margarine

Yield: 6 Servings

In medium glass bowl, combine cornmeal, milk and salt. Cook at **HIGH** for 3 minutes and then at **MEDIUM-HIGH** for 3 to 4 minutes, or until cornmeal is thickened; stir until smooth. Add eggs, cheese and butter, stir until cheese and butter are almost melted. Pour into greased 8-inch round dish. Cover with wax paper. Cook at **MEDIUM** 12 to 14 minutes, or until center is almost set. Let stand 10 minutes before serving.

Pies

Prepare pastry according to recipe or package directions.

If desired, for a single crust homemade pastry recipe, substitute $\frac{1}{2}$ cup whole wheat flour for $\frac{1}{2}$ cup all-purpose flour.

Microwave pie crusts are light in color. A few drops of yellow food coloring may be mixed with the liquid before adding liquid to the flour mixture. This will give the crust a pale yellow color.

Roll dough out and gently place in pie plate.

Trim edge so a $\frac{3}{4}$ -inch overhang remains. Roll overhang down to rim of pie plate. Flute edge.

Prick bottom and sides of pastry with fork.

Let pie crust rest 10 minutes. This rest time helps reduce shrinkage.

If desired, brush with dark corn syrup or molasses for sweet fillings, or brush with Worcestershire or soy sauce for savory fillings.

For frozen crust, thaw and remove from foil pie plate and place in an 8- or 9-inch glass pie plate. Place on an inverted pie plate. Heat $\frac{1}{2}$ minute, then prick crust and, if desired, brush with dark corn syrup, molasses, Worcestershire or soy sauce.

For crumb crusts, combine $\frac{1}{3}$ cup butter and $\frac{1}{4}$ cup sugar in medium bowl. Heat at **HIGH** $1\frac{1}{2}$ to 2 minutes, or until butter is melted. Stir in $1\frac{1}{4}$ cups crumbs (graham crackers, chocolate or vanilla wafers). Firmly pat into greased 9-inch pie plate.

Cook according to directions given in chart.

Visually check for doneness. Pastry crusts should be opaque. If crust is undercooked, add cooking time in 15 second increments.

Let stand until cool. Chill crumb crusts.

PIE CRUST CHART

ITEM	POWER	APPROX. COOKING TIME (in minutes)
Homemade or Mix	HIGH	3 to 4
Refrigerated	MEDIUM-HIGH	$4\frac{1}{2}$ to 5
Frozen	HIGH	2 to $2\frac{1}{2}$
Graham Cracker or Cookie Crumb	MEDIUM-HIGH	2 to $2\frac{1}{2}$

COCONUT LEMON MERINGUE PIE

$1\frac{1}{2}$ cups sugar
 $\frac{1}{2}$ cup cornstarch
 $\frac{1}{4}$ teaspoon salt
 $1\frac{1}{2}$ cups boiling water
3 eggs separated
 $\frac{1}{2}$ cup lemon juice
3 tablespoons butter or margarine
Grated peel of 1 lemon
9-inch pie shell, baked (see chart this page)
 $\frac{1}{2}$ cup sugar
 $\frac{1}{4}$ cup coconut

Yield: 8 Servings

In 3-quart casserole, combine $1\frac{1}{2}$ cups sugar, cornstarch and salt, stir in boiling water and cover with lid. Cook at **HIGH** for 6 to $7\frac{1}{2}$ minutes or until thickened. Halfway through cooking, stir twice. Stir small amount of hot mixture into egg yolks; return to hot mixture, beating until well blended. Add lemon juice, butter and lemon peel. Pour into pie shell; set aside. Meanwhile, beat egg whites until soft peaks form; gradually add remaining sugar and beat until stiff. Spread meringue over filling, making sure it touches crust all around the pie edge. Sprinkle with coconut.

Cook at **HIGH** for 4 to 6 minutes, or until meringue is set. Cool completely.

CHOCOLATE ROCKY ROAD PIE

1 package ($3\frac{1}{2}$ oz.) chocolate pudding and pie filling mix
 $1\frac{1}{4}$ cups milk
1 to $1\frac{1}{2}$ cups miniature marshmallows
 $\frac{1}{2}$ to 1 cup coarsely chopped walnuts
9-inch chocolate cookie crumb crust, baked (see chart this page)

Yield: 8 Servings

Combine pudding mix and milk in 4-cup glass measure. Cook at **MEDIUM-HIGH** for 6 to 8 minutes or until pudding is thickened, stir until smooth. Cook 5 minutes then fold in marshmallows and nuts. Turn into prepared crust; chill until firm. Garnish with toasted coconut or chopped nuts.

Microwave Shortcuts

FOOD	POWER	TIME (in minutes)	DIRECTIONS
To Melt Butter , ¼ pound To Soften Butter , ¼ pound	MEDIUM MEDIUM-LOW	1 - 2 ½ - 1	Remove wrapper and place butter in a microwave-safe dish.
To Melt Chocolate , 1 square (1 oz.) To Melt Chocolate , ½ cup chips	MEDIUM MEDIUM	2 - 3 2 - 3	Remove wrapper and place chocolate in dish. Stir before adding more time. Chocolate holds its shape even when softened.
To Separate Bacon , 1 lb.	HIGH	½ - 1	Remove wrapper. After heating, use a plastic spatula to separate slices.
To Soften Cream Cheese , 3 oz.	MEDIUM-LOW	½ - 1	Remove wrapper and place in a bowl.
Cup of Water 1 cup (8 oz.) 2 cups (16 oz.) Cup of Milk 1 cup (8 oz.) 2 cups (16 oz.)	HIGH HIGH MEDIUM-HIGH MEDIUM-HIGH	4 6½ 3½ - 4½ 7 - 8	Heated liquids can erupt if not mixed with air. Do not heat liquids in your microwave oven without stirring first.
To Toast Coconut , ⅓ cup	HIGH	1 - 3	Place in a pie plate or bowl. Stir every 30 seconds.
To Brown Ground Beef , 1 lb.	HIGH	3 - 5	Crumble in microwave-safe colander set in another dish. Stir twice.
To Soften Ice Cream , ½ gallon	MEDIUM-LOW	3 - 4	_____
To Roast Nuts , 1½ cups	HIGH	3 - 5	Spread nuts in 9-inch pie plate. Stir twice.
To Toast Sesame Seeds , ¼ cup	HIGH	2½ - 4	Place in a small bowl. Stir twice.
To Soften Brown sugar	HIGH	½ - ¾	Place 1 cup hard brown sugar in dish with a slice of bread or a wedge of apple. Cover with plastic wrap.
To Remove Oven Odors	HIGH	5	Combine 1 to 1½ cups of water with the juice and peel of one lemon in a small bowl. After heating, wipe interior of oven with damp cloth.

Before Requesting Service

All these things are normal:

The oven causes interference with my TV.

Some radio and TV interference might occur when you cook with the microwave oven. This interference is similar to the interference caused by small appliances such as mixers, vacuums, blow dryers, etc. It does not indicate a problem with your oven.

The oven lights dim.

When cooking with a power other than HIGH, the oven must cycle to obtain the lower power levels. The oven light will dim and clicking noises can be heard when the oven cycles.

Steam accumulates on the oven door and warm air comes from the oven vents.

During cooking, steam and warm air are given off from the food. Most of the steam and warm air are removed from the oven by the air which circulates in the oven cavity. However, some steam will condense on cooler surfaces such as the oven door. This is normal.

I accidentally ran my microwave oven without any food in it.

Running the oven empty for a short time will not damage the oven. However, we do not recommend operating the microwave oven without any food in it.

PROBLEM

POSSIBLE CAUSE

REMEDY

Oven will not turn on.

The oven is not plugged in securely.

Remove plug from outlet, wait 10 seconds and reinsert.

Circuit breaker or fuse is tripped or blown.

Reset circuit breaker or replace fuse.

There is a problem with the outlet.

Plug another appliance into the outlet to check if it is working.

Oven will not start cooking.

The door is not closed completely.

Close the oven door securely.

Start Pad was not pressed after programming.

Press **Start** Pad.

Another program entered already in the oven.

Press **Stop/Reset** Pad to cancel the previous program and program again.

The program is not correct.

Program again according to the Operating Instructions.

Stop/Reset Pad has been pressed accidentally.

Program oven again.

The words "DEMO MODE" appear on the screen.

Clock pad has been pressed three times, or Function "6" was pressed.

Deactivate mode by pressing Clock Pad three times, or clear Function.

When the oven is turning on, there is noise coming from the glass tray.

The roller ring and oven bottom are dirty.

Clean these parts according to Care of Your Oven (next page).

If you have any questions or it seems there is a problem with the oven, contact PANASONIC CUSTOMER SERVICE for assistance.
1-800-211-PANA (7262) (9 a.m. - 9 p.m., E.S.T, Toll Free)

Care of Your Microwave Oven

BEFORE CLEANING:

Unplug at socket of the oven. If impossible, leave oven door open to prevent oven from accidentally turning on.

AFTER CLEANING:

Be sure to replace the Roller Ring and Glass Tray in the proper position and press **Stop/Reset** Pad to clear the screen.

Inside of the oven:

Wipe with a damp cloth. Mild detergent may be used if the oven gets very dirty. The use of harsh detergent or abrasives is not recommended.

Glass Tray:

Remove and wash in warm sudsy water or in a dishwasher.

Outside oven surfaces.

Clean with a damp cloth. To prevent damage to the operating parts inside the oven water should not be allowed to seep into ventilation openings.

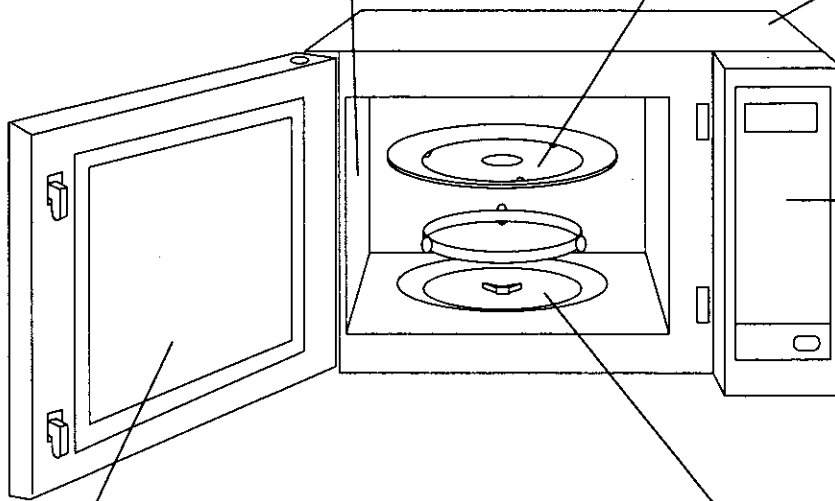

Control Panel:

*Covered with a removable protective film to prevent scratches during shipping. Small bubbles may appear under this film. When this happens, remove film carefully. (Hint - apply masking or clear tape to an exposed corner and pull gently to remove).

*If it becomes wet, clean with a soft, dry cloth. Do not use harsh detergents or abrasives on the control panel.

Roller Ring and oven cavity floor:

Wipe the bottom surface of the oven with mild detergent water or window cleaner and dry. Roller Ring may be washed in mild sudsy water or dishwasher. These areas should be kept clean to avoid excessive noise.

Oven Door:

Wipe with a soft cloth when steam accumulates inside or around the outside of the oven door. During cooking, especially under high humidity conditions, steam is given off from the food. (Some steam will condense on cooler surfaces, such as the oven door.) This is normal.

For more information regarding microwave cooking, order our new COOKING GUIDE.

DESCRIPTION	PART NUMBER	PRICE
Instruction/Operating Manual (this book)	B0003957AAP	①
Cooking Guide (Recipes & Cooking Charts)	B000B8250AP	①
Glass Tray (see diagram on page 6)	A06014000AP (NN-T687 / NN-R687)	\$24.31
Roller Ring Assembly (see diagram on page 6)	B290D9330AP (NN-T687 / NN-R687)	\$ 13.16

① For pricing quotes, call or write the Parts & Literature Department at the phone or address listed below. Please have your credit card information readily available.
Shipping & handling are not included. Price & availability subject to change. Sorry, no COD's.

PANASONIC SERVICES COMPANY
 20421 84th Avenue South
 Kent, WA 98032

(800) 833-9626 - Phone
 (800) 237-9080 - FAX