

# Panasonic®

## Operating Instructions

Microwave Oven  
Models NN-S562  
NN-S592



This manual contains Safety Instructions, Operating Instructions and Maintenance of the oven.  
Before operating this oven, please read these instructions completely.

Antes de operar este producto, lea este instructivo en su totalidad.

El manual de instrucciones en español puede ser encontrada en la páginas 22-29  
(Spanish Operating Instructions can be found on pages 22-29)

For assistance, please call :1-800-211-PANA(7262)  
or send e-mail to :[consumerproducts@panasonic.com](mailto:consumerproducts@panasonic.com)  
or visit us at [www.panasonic.com](http://www.panasonic.com)

(U.S.A)

For assistance, please call : 787-750-4300  
or visit us at [www.panasonicpr.com](http://www.panasonicpr.com)

(Puerto Rico)

Thank you for purchasing a Panasonic Microwave Oven.

## PRECAUTIONS TO AVOID POSSIBLE EXPOSURE TO EXCESSIVE MICROWAVE ENERGY

- (a) Do not attempt to operate this oven with the door open since open-door operation can result in harmful exposure to microwave energy. It is important not to defeat or tamper with the safety interlocks. Under normal conditions oven will not operate with door open.
- (b) Do not place any object between the oven front face and the door or allow soil or cleaner residue to accumulate on sealing surfaces.
- (c) Do not operate the oven if it is damaged. It is particularly important that the oven door close properly and that there is no damage to the:
  - (1) door (bent),
  - (2) hinges and latches (broken or loosened),
  - (3) door seals and sealing surfaces.
- (d) The oven should not be adjusted or repaired by anyone except properly qualified service personnel.

### Technical Specifications

	NN-S562/NN-S592
Power Source	120 V 60 Hz
Power Consumption:	11.5 Amps, 1,320 W
Output:*	1,300 W
Outside Dimensions (H x W x D):	11 <sup>7</sup> / <sub>8</sub> " x 20 <sup>3</sup> / <sub>8</sub> " x 15 <sup>7</sup> / <sub>8</sub> " (301 x 518 x 404 mm)
Oven Cavity Dimensions (H x W x D):	8 <sup>7</sup> / <sub>8</sub> " x 14 <sup>3</sup> / <sub>4</sub> " x 15 <sup>3</sup> / <sub>16</sub> " (225 x 375 x 386 mm)
Operating Frequency:	2,450 MHz
Uncrated Weight:	Approx. 23 lbs. (10.5 kg)

\*IEC 705-88 Test procedure

Specifications subject to change without notice.

The serial number of this product may be found on the back side of the oven. You should note the model number and the serial number of this oven in the space provided and retain this book as a permanent record of your purchase for future reference.

Model No. \_\_\_\_\_

Serial No. \_\_\_\_\_

Date of Purchase \_\_\_\_\_

# CONTENTS

## Before Operating

Precautions .....	Inside Front Cover
Important Safety Instructions .....	2-3
Installation and Grounding Instructions .....	4
Safety Precautions .....	5
Cookware and Utensil Guide .....	6
Feature Diagram .....	7
Control Panel .....	7

## Operation

Let's Start to Use Your Oven .....	8
Clock Setting .....	8
To Use Child Safety Lock .....	9
To Use More/Less Pad .....	9
To Use Popcorn Pad .....	9
To Use Bacon Pad .....	10
To Reheat using	
Power & Time Setting .....	8
Sensor Reheat .....	12
To Defrost using	
Power & Time Setting .....	8
Inverter Turbo Defrost .....	10-11
To Cook using	
Power & Time Setting .....	8
Sensor Cook .....	12-14
Quick Min Function .....	10
Timer Setting (Kitchen Timer / Stand Time / Delay Start) .....	15
Microwave Shortcuts .....	16
Food Characteristics .....	17
Cooking Techniques .....	17-18
Quick Guide to Operation .....	Back Cover

## Maintenance

Technical Specifications .....	Inside Front Cover
Care of Your Microwave Oven .....	19
To Order Accessories, Books, etc. ....	19
Before Requesting Service .....	20
Limited Warranty & Customer Services Directory .....	21

## Manual de instrucciones (Spanish Operating Instructions)

Precauciones .....	22
Instrucciones de Seguridad .....	22-23
Instrucciones para Conexión a Tierra .....	23
Instrucciones de Instalación .....	24
Sugerencias Útiles .....	25
Panel de Control .....	26
Procedimientos de Operación .....	27-28
Guía Rápida de Operación .....	29

**For assistance, PLEASE CALL 1-800-211-PANA (7262)**

# IMPORTANT SAFETY INSTRUCTIONS

Your microwave oven is a cooking device and you should use as much care as you use with a stove or any other cooking device. When using this electric appliance, basic safety precautions should be followed, including the following:

**WARNING**—To reduce the risk of burns, electric shock, fire, injury to persons, or exposure to excessive microwave energy:

1. Read all instructions before using the appliance.
2. Read and follow the specific **"PRECAUTIONS TO AVOID POSSIBLE EXPOSURE TO EXCESSIVE MICROWAVE ENERGY,"** found on the inside front cover.
3. This appliance must be grounded. Connect only to properly grounded outlet. See **"GROUNDING INSTRUCTIONS"** found on page 4.
4. Install or locate this appliance only in accordance with the installation instructions found on page 4.
5. Do not cover or block any openings on this appliance.
6. Do not store or use this appliance outdoors.  
Do not use this product near water—for example, near a kitchen sink, in a wet basement, or near a swimming pool, and the like.
7. Use this appliance only for its intended use as described in this manual. **DO NOT** use corrosive chemicals, vapors, or non-food products in this appliance. This type of oven is specifically designed to heat, or cook. It is not designed for industrial or laboratory use. The use of corrosive chemicals in heating or cleaning will damage the appliance and may result in radiation leaks.
8. When cleaning surfaces of door and oven that come together on closing the door, use only mild, non-abrasive soaps or detergents applied with a sponge or soft cloth.
9. Do not allow children to use this appliance, unless closely supervised by an adult.
10. Do not operate this appliance if it has a damaged cord or plug, if it is not working properly, or if it has been damaged or dropped.
11. Do not immerse cord or plug in water.
12. Keep cord away from heated surfaces.
13. Do not let cord hang over edge of a table or counter.
14. This appliance should be serviced only by qualified service personnel. Contact the nearest authorized servicenter for examination, repair or adjustment.
15. Some products such as whole eggs, narrow neck bottles and sealed containers—for example, closed glass jars—may explode and should not be heated in this oven.
16. To reduce the risk of fire in the oven cavity:
  - (a) Do not overcook food. Carefully attend appliance if paper, plastic, or other combustible materials are placed inside the oven to facilitate cooking.
  - (b) Remove wire twist-ties from paper or plastic bags before placing bag in oven.
  - (c) **If materials inside the oven should ignite, keep oven door closed, turn oven off, and disconnect the power cord, or shut off power at the fuse or circuit breaker panel.**
  - (d) Do not use the cavity for storage purposes. Do not leave paper products, cooking utensils, or food in the cavity when not in use.
17. Liquids, such as water, coffee, or tea are able to be overheated beyond the boiling point without appearing to be boiling due to surface tension of the liquid. Visible bubbling or boiling when the container is removed from the microwave oven is not always present. **THIS COULD RESULT IN VERY HOT LIQUIDS SUDDENLY BOILING OVER WHEN A SPOON OR OTHER UTENSIL IS INSERTED INTO THE LIQUID.** To reduce the risk of injury to persons:
  - (a) Do not overheat the liquid.
  - (b) Stir the liquid both before and halfway through heating it.
  - (c) Do not use straight-sided containers with narrow necks.
  - (d) After heating, allow the container to stand in the microwave oven for a short time before removing the container.
  - (e) Use extreme care when inserting a spoon or other utensil into the container.

## SAVE THESE INSTRUCTIONS

For proper use of your oven read remaining safety cautions and operating instructions.

# IMPORTANT SAFETY INSTRUCTIONS

## General Use

1. **DO NOT** tamper with or make any adjustments or repairs to door, Control Panel housing, safety interlock switches or any other part of the oven. **DO NOT** remove outer panel from oven. Repairs must only be done by a qualified service person.
2. **DO NOT** operate the oven empty. The microwave energy will reflect continuously throughout the oven causing overheating, if food or water is not present to absorb energy. This could damage the oven and result in the risk of a fire.
3. **DO NOT** dry clothes, newspapers or other materials in oven, or use newspapers or paper bags for cooking. Fire could result.
4. **DO NOT** use recycled paper products unless the paper product is labeled as safe for microwave oven use. Recycled paper products may contain impurities which may cause sparks, and result in fires when used.
5. **DO NOT** hit or strike Control Panel. Damage to controls may occur. Fire could result.
6. **POT HOLDERS** should always be used when removing items from the oven. Heat is transferred from the **HOT** food to the cooking container and from the cooking container to the Glass Tray. The Glass Tray can be very **HOT** after removing the cooking container from the oven.
7. **DO NOT** store flammable materials next to, on top of, or in the oven. These could be fire hazards.

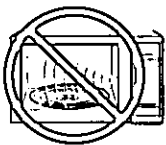
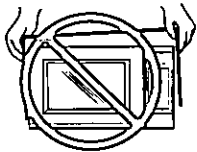

## Glass Tray

1. **DO NOT** operate the oven without Roller Ring and Glass Tray in place.
2. **DO NOT** operate the oven without the Glass Tray fully engaged on the drive hub. Improper cooking or damage to the oven could result. Verify that the Glass Tray is properly engaged and rotating by observing its rotation when you press **Start**.
3. Only use the Glass Tray specifically designed for this oven. Do not substitute any other glass tray.
4. If the Glass Tray is hot, allow to cool before cleaning or placing in water.
5. **DO NOT** cook directly on the Glass Tray. Always place food in a microwave-safe dish, or on a rack set in a microwave-safe dish.
6. If food or utensil on the Glass Tray touches oven walls, causing the tray to stop moving, the tray will automatically rotate in the opposite direction. This is normal.
7. Glass Tray can turn in either direction.

## Roller Ring

1. Roller Ring and oven floor should be cleaned frequently to prevent excessive noise.
2. Roller Ring must always be used for cooking along with Glass Tray.
3. Always replace Roller Ring and Glass Tray in their proper positions.

# INSTALLATION AND GROUNDING INSTRUCTIONS

## Examine Your Oven

Unpack oven, remove all packing material and examine the oven for any damages such as dents, broken door latches or cracks in the door. Notify dealer immediately if oven is damaged. **DO NOT** install if oven is damaged.

## Placement of Oven

- Oven must be placed on a flat, stable surface. For proper operation, the oven must have sufficient air flow. Allow 3-inches (7.6 cm) of space on both sides of the oven and 1-inch (2.5 cm) of space of space on top of oven.
  - DO NOT** block air vents. If they are blocked during operation, the oven may be overheated and damaged. When using any cloth over the oven, the air intake and exhaust should not be blocked. Also should allow space on back and both sides of oven properly.
  - DO NOT** place oven near a hot, damp surface such as a gas or electric range, or dishwasher.
  - DO NOT** operate oven when room humidity is too high.
- This oven was manufactured for household use only.

## Grounding Instructions

**This appliance must be grounded.** In the event of an electrical short circuit, grounding reduces the risk of electric shock by providing an escape wire for the electric current. This appliance is equipped with a cord having a grounding wire with a grounding plug. The plug must be plugged into an outlet that is properly installed and grounded.

**WARNING**—Improper use of the grounding plug can result in a risk of electric shock.

Consult a qualified electrician or service person if the grounding instructions are not completely understood, or if doubt exists as to whether the appliance is properly grounded. If it is necessary to use an extension cord, use only a three wire extension cord that has a three blade grounding plug, and a three slot receptacle that will accept the plug on the appliance. The marked rating of the extension cord should be equal to or greater than the electrical rating of the appliance.

## Power Supply

- A short power-supply cord is provided to reduce the risks resulting from becoming entangled in or tripping over a longer cord.
- Longer cord sets or extension cords are available and may be used if care is exercised in their use.
- If a long cord or extension cord is used, (1) the marked electrical rating of the cord set or extension cord should be at least as great as the electrical rating of the appliance, (2) the extension cord must be a grounding-type 3-wire cord, and (3) the longer cord should be arranged so that it will not drape over the counter top or tabletop where it can be pulled on by children or tripped over accidentally.

## Wiring Requirements

- The oven must be operated on a SEPARATE CIRCUIT. No other appliance should share the circuit with the microwave oven. If it does, the branch circuit fuse may blow, the circuit breaker may trip, or the food may cook slower than the times recommended in this manual.
- The VOLTAGE used must be the same as specified on this microwave oven (120 V, 60 Hz). Using a higher voltage is dangerous and may result in a fire or another incident causing oven damage. Using a lower voltage will cause slow cooking. Panasonic is **NOT** responsible for any damages resulting from the use of the oven with any voltage other than specified.
- The oven must be plugged into at least a 20 AMP, 120 VOLT, 60 Hz GROUNDED OUTLET. Where a standard two-prong outlet is encountered, it is the personal responsibility and obligation of the consumer to have it replaced with a properly grounded three-prong outlet.



## TV / Radio Interference

- Operation of the microwave oven may cause interference to your radio, TV or similar equipment.
- When there is interference, it may be reduced or eliminated by taking the following measures:
  - Clean door and sealing surfaces of the oven. (See Care of Your Microwave Oven)
  - Place the radio, TV, etc. away from the microwave oven as far as possible.
  - Use a properly installed antenna to obtain stronger signal reception.

# Safety Precautions

## Follow These Safety Precautions When Cooking in Your Oven

### **IMPORTANT**

Proper cooking depends upon the power, the time set and quantity of food. If you use a smaller portion than recommended and cook at the time for the recommended portion, fire could result.

#### **1) HOME CANNING / DRYING FOODS / SMALL QUANTITIES OF FOODS**

- Do not use your oven for home canning, your oven cannot maintain the food at the proper canning temperature. Improperly canned food may spoil and be dangerous to consume.
- Do not dry meats, herbs, fruits or vegetables in your oven. Small quantities of food or foods with low moisture content can dry out, scorch or catch on fire if overheated.

#### **2) POPCORN**

Popcorn may be popped in a microwave oven corn popper. Microwave popcorn which pops in its own package is also available. Follow popcorn manufacturers' directions and use a brand suitable for the wattage of your microwave oven.

**CAUTION:** When using pre-packaged microwave popcorn, follow recommended package instructions. Check package weight before using the *Popcorn pad* (see *Popcorn Pad* section). Set the oven for the weight of the popcorn package. If these instructions are not followed, the popcorn may not pop adequately or may ignite and cause a fire. Never leave oven unattended when popping popcorn. Allow the popcorn bag to cool before opening, always open the bag away from your face and body to prevent steam burns.

#### **3) DEEP FAT FRYING**

- Do not attempt to deep fat fry in your microwave oven. Cooking oils may burst into flames and may cause damage to the oven and perhaps result in burns. Microwave utensils may not be able to withstand the temperature of the hot oil, and could shatter or melt.

#### **4) FOODS WITH NONPOROUS SKINS**

- Potatoes, apples, egg yolks, whole eggs, whole squash and sausages are examples of foods with nonporous skins. These types of foods must be pierced before microwave cooking to prevent their bursting.
- Use fresh potatoes for baking and cook until just done. Use recommended weights for programmed cooking. Overcooking causes dehydration and may result in a fire.

#### **5) GLASS TRAY / COOKING UTENSILS / FOIL**

- Cooking utensils get hot during microwaving. Heat is transferred from the HOT food to the

container and the Glass Tray. Use potholders when removing utensils from the oven or when removing lids or plastic wrap covers from cooking utensils, to avoid burns.

- The Glass Tray will get hot during cooking. It should be allowed to cool before handling or before paper products, such as paper plates or microwave popcorn bags, are placed in the oven for microwave cooking.
- When using foil, skewers, warming rack or utensils made of metal in the oven, allow at least 1-inch (2.5 cm) of space between metal material and interior oven walls. If arcing occurs (sparking), remove metal material (skewers etc.) and/or transfer to a non-metallic container.
- Dishes with metallic trim should not be used, as arcing may occur.
- If an entree is heated in a foil tray, maintain at least 1-inch (2.5 cm) spacing from the oven walls.

#### **6) PAPER TOWELS / CLOTHS**

- DO NOT use paper towels or cloths which contain a synthetic fiber woven into them. The synthetic fiber may cause the towel to ignite. Use paper toweling under supervision.

#### **7) BROWNING DISHES / OVEN COOKING BAGS**

- Browning dishes or grills are designed for microwave cooking only. Always follow instructions provided by the manufacturer. DO NOT preheat browning dish more than 6 minutes.
- If an oven cooking bag is used for microwave cooking, prepare according to package directions. DO NOT use a wire twist-tie to close bag, instead use plastic ties, cotton string or a strip cut from the open end of the bag.

#### **8) THERMOMETERS**

- DO NOT use a conventional meat thermometer in your oven. Arcing may occur. Microwave-safe thermometers are available for both meat and candy.

#### **9) BABY FORMULA / FOOD**

- DO NOT heat baby formula or food in the microwave oven. The glass jar or surface of the food may appear warm while the interior can be so hot as to burn the infant's mouth and esophagus.

#### **10) REHEATING PASTRY PRODUCTS**

- When reheating pastry products, check temperatures of any fillings before eating. Some foods have fillings which heat faster and can be extremely hot, while the surface remains warm to the touch (ex. Jelly Donuts).

#### **11) GENERAL OVEN USAGE GUIDELINES**

- DO NOT use the oven for any reason other than the preparation of food.
- DO NOT leave oven unattended while in use.

## Cookware and Utensil Guide

ITEM	MICROWAVE	COMMENTS
Aluminum Foil	Yes for Shielding only	Small strips of foil can be molded around thin parts of meat or poultry to prevent overcooking. Arcing can occur if foil is too close to oven wall or if too much foil is used.
Browning Dish	Yes	Browning dishes are designed for microwave cooking only. Check browning dish information for instructions and heating chart. Do not preheat for more than 6 minutes.
Brown paper bags	No	May cause a fire in the oven.
Dinnerware Labeled "Microwave-Safe"	Yes	Check manufacturers' use and care directions for use in microwave heating. Some dinnerware may state on the back of the dish, "Oven-Microwave Safe".
Other Dinnerware	?	Use <b>CONTAINER TEST</b> below.
Disposable polyester Paperboard Dishes	Yes	Some frozen foods are packaged in these dishes. Can be purchased in grocery stores.
Fast Food Carton with Metal Handle	No	Metal handle may cause arcing.
Frozen Dinner Tray Metal	Yes	Frozen dinners may be heated in foil tray, if tray is less than 7/4-in. (2 cm) high. Place foil tray in center of oven. Leave at least 1-in. (2.5 cm) space between foil tray and oven walls. Heat only 1 foil tray in the oven at a time. For containers more than 7/4-inch (2 cm) deep, remove food and place in a similar size microwave-safe container.
Microwave-safe	Yes	
Glass Jars	Yes, use caution	Remove lid. Heat food until just warm, not HOT. Most glass jars are not heat resistant. Do not use for cooking.
Glassware Heat Resistant Oven Glassware & Ceramics	Yes	Ideal for microwave cooking and browning. (See <b>CONTAINER TEST</b> below)
Metal Bakeware	No	Not recommended for use in microwave ovens.
Metal Twist-Ties	No	May cause arcing which could cause a fire in the oven.
Oven Cooking Bag	Yes	Follow manufacturers' directions. Close bag with the nylon tie provided, a strip cut from the end of the bag, or a piece of cotton string. Do not close with metal twist-tie. Make six 1/2-in. (1 cm) slits near the closure.
Paper Plates & Cups	Yes	Use to warm cooked foods, and to cook foods that require short cooking times such as hot dogs.
Paper Towels & Napkins	Yes	Use to warm rolls and sandwiches by microwave.
Parchment Paper	Yes	Use as a cover to prevent spattering. Safe for use in microwave, microwave/convection and conventional ovens.
Plastic Microwave-Safe Cookware Reheat & Storage	Yes	Should be labeled, "Suitable for Microwave Heating." Check manufacturers' directions for recommended uses. Some microwave-safe plastic dishes are not suitable for cooking foods with high fat or sugar content. The heat from hot food may cause the plastic to warp.
Melamine	No	
Plastic Foam Cups	Yes, use caution	Plastic foam will melt if foods reach a high temperature. Use to bring foods to a low serving temperature.
Plastic Wrap	Yes	Use to cover food during cooking to retain moisture and prevent spattering. Should be labeled "Suitable for Microwave Heating". Check package directions.
Straw, Wicker, Wood	Yes	Use only for short term reheating and to bring food to a low serving temperature.
Thermometers Microwave-safe, only	Yes	Use only microwave-safe meat and candy thermometers. Not suitable for use in microwave oven, will cause sparks and get hot.
Conventional	No	
Wax paper	Yes	Use as a cover to prevent spattering and to retain moisture.

### CONTAINER TEST

**TO TEST A CONTAINER FOR SAFE MICROWAVE OVEN USE:** Fill a 1-cup glass measure with water and place it in the microwave oven along with the container to be tested; **heat one (1) minute at P10 (HIGH)**. If the container is microwave oven-safe (transparent to microwave energy), the container should remain comfortably cool and the water should be hot. If the container is hot, it has absorbed some microwave energy and should NOT be used. This test cannot be used for plastic containers.



## Feature Diagram

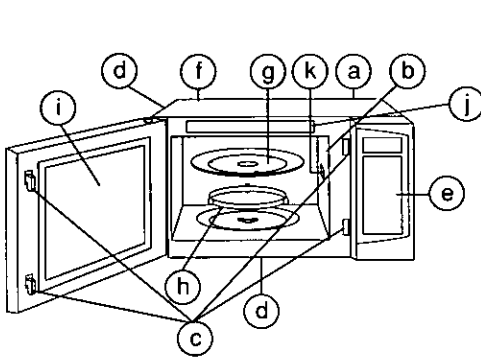

- (a) External Air Vents
- (b) Internal Air Vents
- (c) Door Safety Lock System
- (d) Exhaust Air Vents
- (e) Control Panel
- (f) Identification Plate
- (g) Glass Tray
- (h) Roller Ring
- (i) Heat/Vapor Barrier Film  
(do not remove)
- (j) Menu Label
- (k) Cover (do not remove)

### Oven Light:

Oven Light turns on only while cooking and will not turn on when oven door is opened.

## Control Panel

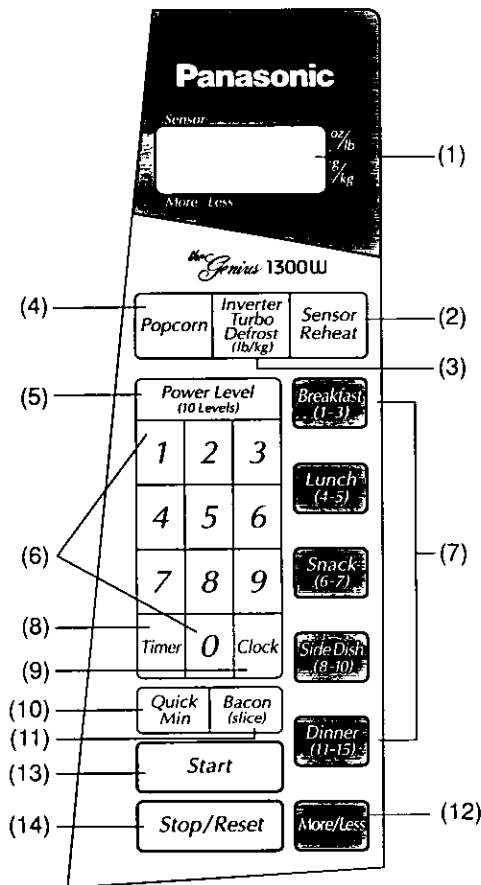

- (1) Display Window
- (2) Sensor Reheat Pad (page 12)
- (3) Inverter Turbo Defrost Pad (page 10)
- (4) Popcorn Pad (page 9)
- (5) Power Level Pad (page 8)
- (6) Number Pads
- (7) Sensor Cook Pads (page 12)
- (8) Timer Pad (page 15)
- (9) Clock Pad (pages 8)
- (10) Quick Min Pad (page 10)
- (11) Bacon Pad (page 10)
- (12) More/Less Pad (page 9, 12)

(13) **Start Pad**  
One tap allows oven to begin functioning. If door is opened or **Stop/Reset** Pad is pressed once during oven operation, **Start** Pad must be pressed again to restart oven.

(14) **Stop/Reset Pad**  
**Before cooking:** One tap clears your instruction.  
**During cooking:** One tap temporarily stops the cooking process. Another tap cancels all your instructions and time of day or colon appears on the **Display Window**.

**Beep Sound:**  
When a pad is pressed correctly, a beep will be heard.  
If a pad is pressed and no beep is heard, the unit did not or cannot accept the instruction. The oven will beep twice between programmed stages. At the end of any complete program, the oven will beep 5 times.

## Let's Start to Use Your Oven!

1. Plug into a properly grounded electrical outlet.



### Display Window

The oven automatically displays weights in imperial (oz/lb).

88:88 <sup>oz/lb</sup>/<sub>g/kg</sub>

2. If you wish to use metric (g/kg):

Start

→ <sup>oz/lb</sup>/<sub>g/kg</sub>

Press **Start** to convert to metric. Verify your selection on the **Display Window**.

→ <sup>oz/lb</sup>/<sub>g/kg</sub>

3. **Stop/Reset** Colon appears on **Display Window**.  
Press



: :

Now, enjoy cooking with your Panasonic microwave.

## Clock Setting

The oven will operate without setting the clock.

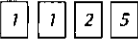
**Example: To set 11:25 a.m. or p.m.**

1. 	• Press once. ▶ Colon flashes.
2. 	• Enter time of day using the number pads. ▶ Time appears on the <b>Display Window</b> ; colon continues flashing.
3. 	• Press. ▶ Colon stops flashing; time of day is entered.

### NOTES:

1. To reset the clock, repeat steps 1- 3.
2. The clock will retain the time of day as long as the oven is plugged in and electricity is supplied.
3. Clock is a 12 hour display.
4. Oven will not operate while colon is flashing.

## Power & Time Setting

This feature allows you to manually set the power and time for microwave cooking.

**Example: To cook at P 6 (MEDIUM) Power for 1 minute 30 seconds**

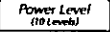
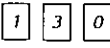
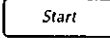
1.  Press 5 times.	• Select <b>Power Level</b> . (according to the chart below)
2. 	• Set Cooking Time using number pads.
3. 	• Press. ▶ Cooking will start. The time on the <b>Display Window</b> will count down.

Press	Power Level
once	P10 (HIGH)
twice	P 9
3 times	P 8
4 times	P 7 (MEDIUM-HIGH)
5 times	P 6 (MEDIUM)
6 times	P 5
7 times	P 4
8 times	P 3 (MEDIUM-LOW)/DEFROST
9 times	P 2
10 times	P 1 (LOW)

### NOTES:

1. For more than one stage cooking, repeat steps 1 and 2 for each stage of cooking before pressing **Start** Pad. The maximum number of stages for cooking is 5 stages.
2. When selecting P10 (HIGH) power for the first stage, you may begin at step 2.
3. Two beeps will sound between each stage of programming. Five beeps will sound at the end of the entire sequence.
4. When selecting P10 (HIGH) power, the maximum programmable time is 30 minutes. For other power levels, the maximum time is 99 minutes and 99 seconds.
5. For reheating, use P10 (HIGH) for liquids, P7 (MEDIUM-HIGH) for most foods and P6 (MEDIUM) for dense foods.
6. For defrosting, use P3 (MEDIUM-LOW).

## To Use Child Safety Lock

This feature prevents the electronic operation of the oven until cancelled. It does not lock the door.

### To Set:



Press 3 times.

- "Child" appears on the Display Window.
- ▶ "Child" continues to be displayed until Child Lock is cancelled. Keypads may be pressed but the microwave will not start.

### To Cancel:



Press 3 times.

- The Display Window will return to color or time of day when Child Lock has been cancelled.

## To Use More/Less Pad

### For Popcorn:

When using Popcorn pad, maybe the weight is not the same as offered. By using the More/Less pad, the programs can be adjusted to cook food for a longer or shorter time or a heavier or lighter weight.

- 1 tap = More Cooking
- 2 taps = More+ Cooking
- 3 taps = Less Cooking
- 4 taps = Less- Cooking
- 5 taps = original setting

### For Sensor Reheat/Cook:

Preferences for food doneness vary with each individual. After having used the Sensor Cook feature a few times, you may decide you would prefer your food cooked to a different doneness.

- 1 tap = More Cooking
- 2 taps = Less Cooking
- 3 taps = original setting

Press More/Less pad before pressing Start.

## To Use Popcorn Pad

### Example: To heat 1.75 oz. of Popcorn

1.



Press once

- Set the desired weight of prepackaged microwave popcorn.

Press	Weight
once	1.75 oz. (50g)
twice	2.65 oz. (75g)
3 times	2.85 oz. (80g)
4 times	3.0 oz. (85g)
5 times	3.5 oz. (99g)

2.



Optional.

3.



- Press **Start** Pad.
- ▶ After several seconds, cooking time appears on the **Display Window** and begins to count down.



### NOTES ON POPCORN PAD:

1. Use prepackaged **room temperature** microwave popcorn. Read manufacturers' instructions.
2. Place bag in oven according to manufacturers' directions.
3. Pop only one bag at a time.
4. After popping, allow the contents of the bag to cool for a few minutes before opening. Open bag carefully away from face and body because popcorn and steam are extremely hot.
5. Do not reheat unpopped kernels or reuse bag.
6. **NEVER** leave oven unattended when popping popcorn. Stop the oven when popping slows to 2 to 3 seconds between pops. Overcooking may cause scorching.
7. With the many varieties of microwave popcorn available in the market place, it may be necessary for you to move the popcorn container to the outer edge of the glass tray to obtain the best cooking results.

**REMARK:** When popping multiple bags one right after the other, the cooking times may vary slightly. This does not affect the popcorn results.

## To Use Bacon Pad

**Example: To cook 4 slices of Bacon**

<b>1.</b>  Press once.	• Set the desired number of slices.										
	<table border="1"> <tr> <th>Press</th> <th>Slices</th> </tr> <tr> <td>once</td> <td>4 slices (3.2 - 4 oz.) (90 - 110 g)</td> </tr> <tr> <td>twice</td> <td>6 slices (4.8 - 5.8 oz.) (135 - 165 g)</td> </tr> <tr> <td>3 times</td> <td>10 slices (8.1 - 9.5 oz.) (230 - 270 g)</td> </tr> <tr> <td>4 times</td> <td>14 slices (11.6 - 13 oz.) (330 - 370 g)</td> </tr> </table>	Press	Slices	once	4 slices (3.2 - 4 oz.) (90 - 110 g)	twice	6 slices (4.8 - 5.8 oz.) (135 - 165 g)	3 times	10 slices (8.1 - 9.5 oz.) (230 - 270 g)	4 times	14 slices (11.6 - 13 oz.) (330 - 370 g)
	Press	Slices									
	once	4 slices (3.2 - 4 oz.) (90 - 110 g)									
twice	6 slices (4.8 - 5.8 oz.) (135 - 165 g)										
3 times	10 slices (8.1 - 9.5 oz.) (230 - 270 g)										
4 times	14 slices (11.6 - 13 oz.) (330 - 370 g)										
<b>2.</b> 	• Press <b>Start Pad</b> . ► Cooking time appears on the <b>Display Window</b> and begins to count down.										



### NOTES ON BACON PAD:

- For best results, place bacon on ridged (Bacon) dish. This keeps it away from the grease and helps it to crisp.
- To absorb grease spatters, cover with paper towels.
- If bacon is not cooked to your liking, continue to heat by manually adding more time.

## Quick Min Function

This feature allows you to set and/or add cooking times easily in multiples of one minute.

### To Set Cooking Time:

<b>1.</b> 	• Set cooking time (up to 10) Power Level is P10.
<b>2.</b> 	• Press <b>Start Pad</b> . ► Cooking begins and <b>Display Window</b> counts down. At the end of cooking, 5 beeps sound and colon or time of day appears.

### NOTE:



- You can use other power levels. Select desired power level before setting cooking time.
- After setting the time by **Quick Min** Pad, you cannot use Number Pads, and vice versa.
- Press **Quick Min** Pad to add more time during cooking. To verify the additional cooking time, check the **Display Window**.

## Inverter Turbo Defrost

This feature allows you to defrost meat, poultry and seafood simply by entering the weight.

**Example: To defrost 1.5 pounds of meat.**

Place food on microwave safe roasting rack in an appropriately sized dish.

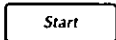
<b>1.</b> 	• Press. "def" appears briefly on the <b>Display Window</b> .
<b>2.</b> 	• Enter weight of the food using the number pads.
<b>3.</b> 	• Press. ► Defrosting will start. The time on the <b>Display Window</b> will count down. Halfway through defrosting, beep sounds. Turn over, rearrange foods, remove defrost areas or shield with aluminum foil. (See directions "DURING DEFROSTING" in page 11.)

### Conversion Chart:

Follow the chart to convert ounces or hundredths of a pound into tenths of a pound. To use Auto Defrost, program the weight of the food in lbs. (1.0) and tenths of a lb. (0.1). If a piece of meat weighs 1.95 lbs. or 1 lb. 14 oz., program 1.9 lbs.

Ounces	Hundredths of a Pound	Tenths of a Pound
0	.01 - .05	0.0
1 - 2	.06 - .15	0.1
3 - 4	.16 - .25	0.2
5	.26 - .35	0.3
6 - 7	.36 - .45	0.4
8	.46 - .55	0.5
9 - 10	.56 - .65	0.6
11 - 12	.66 - .75	0.7
13	.76 - .85	0.8
14 - 15	.86 - .95	0.9

## Defrosting Tips & Techniques

### Before Freezing:

1. Freeze meats, poultry, and fish in packages with only 1 or 2 layers of food. Place wax paper between layers.
2. Package in heavy-duty plastic wraps, bags (labeled "For Freezer") or freezer paper.
3. Remove as much air as possible, i.e. create a vacuum.
4. Seal securely, date, and label.

### To Defrost:

1. Remove wrapper. This helps moisture to evaporate. Juices from food can get hot and cook the food.
2. Set food on microwave safe roasting rack in an appropriately sized dish.
3. Place roasts fat-side down. Place whole poultry breast-side down.
4. Drain liquids during defrosting.
5. Turn over (invert) items during defrosting.
6. Shield edges and ends if needed. (See **Cooking Techniques**).
7. Select power and minimum time so that items will be under-defrosted.

### After Defrosting:



1. Large items may be icy in the center. Defrosting will complete during **STANDING TIME**.
2. Let stand, covered with plastic wrap, in the refrigerator for time shown in the chart below.
3. See chart below for standing time and rinsing directions.
4. Items which have been layered should be rinsed separately or have a longer stand time.

FOOD	DEFROST TIME at P3 (min./lb.)	DURING DEFROSTING	AFTER DEFROSTING	
			Stand Time	Rinse
<b>Fish and Seafood</b> [up to 3 lbs. (1.4 kg)]				
Crabmeat	6	Break apart/Rearrange	5 min.	YES
Fish Steaks	4 to 6	Turn over		
Fish Fillets	4 to 6	Turn over/Rearrange/Shield ends		
Sea Scallops	4 to 6	Break apart/Remove defrosted pieces		
Whole fish	4 to 6	Turn over		
<b>Meat</b>				
Ground Meat	4 to 5	Turn over/Remove defrosted portion/ Shield edges	10 min.	NO
Roasts [2½-4 lbs. (1.1-1.8 kg)]	4 to 8	Turn over/Shield ends and defrosted surface	30 min. in refrig.	
Chops/Steak	6 to 8	Turn over/Rearrange/Shield ends and defrosted surface	5 min.	
Ribs/T-bone	6 to 8	Turn over/Rearrange/Shield ends and defrosted surface		
Stew Meat	4 to 8	Break apart/Rearrange/ Remove defrosted pieces		
Liver (thin sliced)	4 to 6	Drain liquid/Turn over/ Separate pieces		
Bacon (sliced)	4	Turn over		
<b>Poultry</b>				
Chicken, Whole [up to 3 lbs. (1.4 kg)]	4 to 6	Turn over/Shield	20 min. in refrig.	YES
Cutlets	4 to 6	Break apart/Turn over/ Remove defrosted Pieces	5 min.	
Pieces	4 to 6	Break apart/Turn over/Shield	10 min.	
Cornish Hens	6 to 8	Turn over/Shield		
Turkey Breast [5-6 lbs. (2.3-2.7 kg)]	6	Turn over/Shield	20 min. in refrig.	

## Sensor Reheat

This sensor feature allows you to reheat any quantity of food with only one touch. The oven does it all for you.

**Example: To reheat 2 cups of soup**

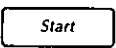
1.		• Press.
2.	 Optional	(see page 9.)
3.		• Press. ▶Cooking starts.

After heat/steam is detected by the **Genius**, 2 beeps sound. The remaining cooking time appears on the **Display Window** and begins to count down.

At the end of cooking, five beeps sound.

### NOTES:

**Casseroles** - Add 3 to 4 tablespoons of liquid; cover with lid or plastic wrap. Stir when time appears on the **Display Window**.

**Canned foods** - Empty contents into casserole dish or serving bowl; cover dish with lid or plastic wrap. After reheating, release plastic wrap and stand.

**Plate of food** - Arrange food on plate; top with butter, gravy, etc.. After reheating, release plastic wrap and stand.

Follow the recommendations for Sensor Cooking, in addition to the following:

### DO NOT:

1. Reheat bread and pastry products. Use manual power and time for these foods.
2. Reheat raw or uncooked food.
3. Use if oven cavity is warm.
4. Use for beverages.
5. Use for frozen foods.

**For the best results with the GENIUS, follow these recommendations.**

### BEFORE Reheating/Cooking



1. The room temperature surrounding the oven should be below 95° F (35° C).
2. Food weight should exceed 4 oz. (110 g).
3. Glass Tray and outside of container should be dry.
4. Cover food loosely with lid, or with vented plastic wrap.
5. All foods should be taken from their normal storage place.

## Sensor Cook

• Breakfast  
• Lunch  
• Snack  
• Side Dish  
• Dinner

This sensor feature allows you to cook any quantity of food with only one touch. The oven does it all for you.

**Example: To cook a 10 oz. Frozen Entrée.**

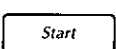
1.		• Press until the desired number of category appears on the <b>Display Window</b> .
	Press twice.	
2.	 Optional	(see page 9.)
3.		• Press. ▶Cooking starts.

After heat/steam is detected by the **Genius**, 2 beeps sound. The remaining cooking time appears on the **Display Window** and begins to count down.

At the end of cooking, five beeps sound.

### DURING Reheating/Cooking:

DO NOT open the oven door until 2 beeps sound and time appears on the **Display Window**. Doing so will cause inaccurate cooking since the steam from food is no longer contained within the oven cavity. Once the timer begins to count down, the oven door may be opened to stir, turn, shield, rearrange, mix or add foods.

### AFTER Reheating/Cooking:

All foods should have a covered stand time.

## Sensor Cook Chart

Pad	Recipe	Serving/Weight	HINTS
<b>Breakfast</b>	1. Oatmeal	1/2 , 1 cup	Place inside a microwave-safe serving bowl with no cover. Follow manufacturers' directions for preparation of quick oatmeal.
	2. Breakfast Sausage	8 maximum	Follow manufacturers' directions for preparation of pre-cooked breakfast sausage. Place in a radial pattern.
	3. Omelet	2, 4 eggs	Follow Basic Omelet recipe on page 14.
<b>Lunch</b>	4. Soup	1 - 2 cups	Pour soup into a microwave-safe serving bowl. Cover loosely with lid or vented plastic wrap.
	5. Frozen Entrées	8 - 32 oz.	Follow manufacturers' directions for preparation of 8 and 10 oz. sizes. For larger sized entrées, where the directions state for the entire film cover to be removed, do not vent or remove film cover to ensure the sensor will detect accurately for complete cooking. Be careful when removing the film cover after cooking. Remove them away from you to avoid steam burns. If additional time is needed, continue to cook manually.
<b>Snack</b>	6. Frozen Pizza (single)	4, 8 oz.	Follow manufacturers' directions for preparation.
	7. Hot Dog	4 maximum	Make 3 slits on each Hot Dog. Place Hot Dog on paper plate or microwave-safe dish leaving space between each. Times may vary by size and manufacturer.
<b>Side Dish</b>	8. Potatoes	4 maximum (6-8 oz. each)	Pierce at least 6 times on top of the potato with a fork. Place potatoes on a microwave-safe dish. Do not cover. Let stand 5 minutes to complete cooking.
	9. Rice	1/2 - 1 1/2 cups	Place rice with hot water in a microwave-safe casserole dish. Cover loosely with lid or vented plastic wrap. Let stand 5 to 10 minutes before serving.
	10. Fresh Vegetables	1/4 - 1 lb.	All pieces should be the same size. Add a small amount of water and cover loosely with lid or vented plastic wrap.
<b>Dinner</b>	11. Chicken Pieces	1/2 - 2 lb.	Place skin-side up. Cover with vented plastic wrap. Let stand 5 minutes before serving.
	12. Ground Meat	1 - 2 lb. (16 - 32 oz.)	Break apart in glass bowl or colander. Cover with vented plastic wrap. After 2 beeps, stir. Re-cover and press <b>Start</b> . Juices should be clear. Drain.
	13. Fish Fillets	1/4 - 1 lb.	Arrange in a single layer. Cover with vented plastic wrap.
	14. Pasta	2 - 8 oz.	Place pasta with hot water in a microwave-safe casserole dish. Cover loosely with lid or plastic wrap. Drain.
	15. Casserole	=	Prepare according to recipes on page 14.

## Sensor Cook Recipe

### OMELET

#### Basic Omelet

- 1 tablespoon butter or margarine
- 2 eggs
- 2 tablespoons milk
- salt and ground black pepper, if desired

Heat butter in a 9-inch pie plate, 30 seconds at P10, or until melted, turn the plate to coat the bottom with butter.

Meanwhile, combine the remaining ingredients in a separate bowl and beat together; pour into the pie plate. Cook, covered with vented plastic wrap, on OMELET. Let stand 2 minutes. With a spatula, loosen the edges of the omelet from the plate; fold into thirds to serve.

Yield: 1 serving

Approx. Cooking Time: 4 minutes

NOTE: Double ingredients for a 4 egg Omelet.

### CASSEROLE

#### Shepherd's Pie

- 1 pound lean ground beef
- 1/2 cup frozen peas, thawed
- 1/4 cup chopped onion
- 1 tablespoon gravy powder
- 1/2 teaspoon curry powder
- 1/4 teaspoon salt
- 1/4 teaspoon ground black pepper
- 2 cups mashed potatoes

In a 2-Qt. casserole dish, crumble the beef and cook for 5-7 minutes at P6, until the meat is cooked; stirring twice. Add the remaining ingredients, except the potatoes. Stir well and spread the potatoes evenly on the top. Cover with a lid and cook on CASSEROLE.

Yield: 4 servings

Approx. Cooking Time: 17 minutes

#### Macaroni and Cheese

- 1/4 cup butter
- 2 tablespoons chopped onion
- 1 clove minced garlic
- 1/4 cup all purpose flour
- 1 teaspoon dry mustard
- 1 teaspoon salt
- 1/4 teaspoon ground black pepper
- 2 cups milk
- 2 cups grated cheddar cheese
- 8 oz. (1/2 lb dry weight) macaroni, cooked and drained
- 1/3 cup bread crumbs
- 1 teaspoon paprika

In a 2-Qt. casserole, melt the butter for 40 seconds at P10. Add onion and garlic and cook for 1 minute at P10. Stir in flour, mustard, salt and pepper then, gradually add the milk. Cook for 3-4 minutes at P10, stirring once. Continue cooking for 3-4 minutes at P10 or until the sauce thickens. Stir in the cheddar cheese. Stir the sauce into the macaroni, in a 3-Qt. casserole. Top with bread crumbs and paprika. Cover with vented plastic wrap. Cook on CASSEROLE.

Yield: 6 servings

Approx. Cooking Time: 17 minutes

#### Beef and Macaroni Casserole

- 1 pound lean ground beef
- 1 small chopped onion
- 1/2 green bell pepper, chopped
- 1 cup chopped celery
- 2 cans (15 oz.) tomato sauce
- 1 1/4 cups water
- 1 cup uncooked elbow macaroni
- 1 teaspoon parsley
- 1/2 teaspoon salt
- 1/4 teaspoon ground black pepper
- 1/2 cup grated cheddar cheese

Crumble the ground beef in a 3-Qt. casserole. Cook for 5 - 7 minutes at P6 or until the meat is cooked; stirring twice. Add onion, peppers and celery. Cook for 3-4 minutes at P10. Add the remaining ingredients, except cheese. Cover with vented plastic wrap. Cook on CASSEROLE. Sprinkle with cheese. Cover and let stand 5 minutes.

Yield: 4-6 servings

Approx. Cooking Time: 17 minutes

#### Tuna Casserole

- 1 can (6 oz.) drained and flaked tuna
- 4 cups cooked and drained noodles
- 1 can (10 1/4 oz.) condensed cream of mushroom soup
- 1 can (4 oz.) mushroom pieces and steams, drained
- 1 package (16 oz.) frozen peas, defrosted
- 3/4 cup milk
- 1 cup crushed potato chips
- 1/2 cup grated cheddar cheese

In a 3-Qt. casserole, combine tuna, noodles, soup, mushrooms, peas and milk; mix well. Cover with vented plastic wrap. Cook on CASSEROLE. Top with potato chips and cheese.

Yield: 4-6 servings

Approx. Cooking Time: 17 minutes





## Timer Setting

This feature allows you to program a Standing Time after cooking is completed and to program the oven as a kitchen timer and/or to program a delay start.



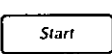

### To Use as a Kitchen Timer:

**Example: To count 5 minutes**

1. 	• Press.
2. 	• Set desired amount of time using number pads. (up to 99 minutes and 99 seconds).
3. 	• Press. ▶ Time will count down without oven operating.

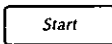

### To Set Stand Time:

**Example: To stand for 5 mins. after cooking (3 mins. at P6-MEDIUM Power)**

1.  5 times ↓ 	• Enter the desired cooking program (see page 8 for directions).
2. 	• Press.
3. 	• Set desired amount of Stand Time using number pads. (up to 99 minutes and 99 seconds)
4. 	• Press. ▶ Cooking will start. After cooking, stand time will count down without oven operating.

### To Set Delay Start:

**Example: To start cooking 5 minutes later. (3 mins. at P6-MEDIUM Power).**

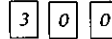
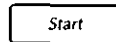
1. 	• Press.
2. 	• Enter desired amount of delayed time using number pads. (up to 99 minutes and 99 seconds)
3.  5 times ↓ 	• Enter the desired cooking program (see page 8 for directions).
4. 	• Press. ▶ Delayed time will count down. Then cooking will start.

### NOTES:

1. When each stage finishes, a two-beep signal sounds. At the end of the program, the oven will beep five times.
2. If oven door is opened during Stand Time or Kitchen Timer, the time on the screen will continue to count down.
3. Stand and Delay time cannot be programmed before any Auto Control Function. This is to prevent the starting temperature of food from rising before defrosting or cooking begins. A change in starting temperature could cause inaccurate results.

## Microwave Shortcuts

FOOD	POWER	TIME (in mins.)	DIRECTIONS
To separate <b>Bacon</b> , 1 pound (450 g)	<b>P10 (HIGH)</b>	30 sec.	Remove wrapper and place in microwave safe dish. After heating, use a plastic spatula to separate slices.
To soften <b>Brown Sugar</b> 1 cup (250 mL)	<b>P10 (HIGH)</b>	20 - 30 sec.	Place brown sugar in microwave-safe dish with a slice of bread. Cover with plastic wrap.
To melt <b>Butter</b> , 1 stick, ¼ pound (110 g)	<b>P6 (MEDIUM)</b>	1½ - 2	Remove wrapper and place butter in a microwave-safe dish covered with plastic wrap.
To soften <b>Butter</b> , 1 stick, ¼ pound (110 g)	<b>P3 (MED-LOW)</b>	1	Remove wrapper and place butter in a microwave-safe dish.
To melt <b>Chocolate</b> , 1 square, 1 oz. (28 g)	<b>P10 (HIGH)</b>	1 - 1½	Remove wrapper and place chocolate in a microwave-safe dish. Stir before adding more time. (Stir until completely melted.) <i>Note: Chocolate holds its shape even when softened.</i>
To melt <b>Chocolate</b> , ½ cup (125 mL) chips	<b>P10 (HIGH)</b>	1 - 1½	
To toast <b>Coconut</b> , ½ cup (125 mL)	<b>P10 (HIGH)</b>	1	Place in a microwave-safe dish. Stir every 30 seconds.
To soften <b>Cream Cheese</b> , 8 oz. (250 g)	<b>P3 (MED-LOW)</b>	1 - 2	Remove wrapper and place in a microwave-safe bowl.
To brown <b>Ground Beef</b> , 1 pound (450 g)	<b>P10 (HIGH)</b>	4 - 5	Crumble into a microwave-safe colander set into another dish. Stir twice. Drain grease.
To steam <b>Hand Towels</b> - 4	<b>P10 (HIGH)</b>	20 - 30 sec.	Soak in water, then wring out excess. Place on a microwave-safe dish. Heat. Present immediately.
To soften <b>Ice Cream</b> , ½ gallon (2 L)	<b>P3 (MED-LOW)</b>	1 - 1½	Check often to prevent melting.
Cup of liquid <b>boiling water, broth, etc.</b> 1 cup, 8 oz. (250 mL) 2 cups, 16 oz. (500 mL) to heat <b>milk</b> 1 cup, 8 oz. (250 mL) 2 cups, 16 oz. (500 mL)	<b>P10 (HIGH)</b>   <b>P7 (MED-HIGH)</b>	  2½ - 3 4  2 - 3 4 - 5	Heated liquids can erupt if not stirred. Do not heat liquids in microwave oven without stirring before and after heating.
To roast <b>Nuts</b> , 1½ cups (375 mL)	<b>P10 (HIGH)</b>	4 - 5	
To toast <b>Sesame Seeds</b> , ¼ cup (50 mL)	<b>P10 (HIGH)</b>	3 - 5	Place in a small microwave-safe bowl. Stir twice.
To skin <b>Tomatoes</b> (one at a time)	<b>P10 (HIGH)</b>	30 sec.	Place tomato into a microwave-safe bowl containing boiling water. Rinse and peel. Repeat for each tomato.
To remove <b>Cooking Odors</b>	<b>P10 (HIGH)</b>	5	Combine 1 to 1½ cups (250 - 375 mL) water with the juice and peel of one lemon in a small microwave-safe bowl. After heating, wipe interior of oven with a cloth.

## Food Characteristics

### Bone and Fat

Both bone and fat affect cooking. Bones may cause irregular cooking. Meat next to the tips of bones may overcook while meat positioned under a large bone, such as a ham bone, may be undercooked. Large amounts of fat absorb microwave energy and the meat next to these areas may overcook.

### Density

Porous, airy foods such as breads, cakes or rolls take less time to cook than heavy, dense foods such as potatoes and roasts. When reheating donuts or other foods with different centers be very careful. Certain foods have centers made with sugar, water, or fat and these centers attract microwaves (For example, jelly donuts). When a jelly donut is heated, the jelly can become extremely hot while the exterior remains warm to the touch. This could result in a burn if the food is not allowed to cool properly in the center.

### Quantity

Two potatoes take longer to cook than one potato. As the quantity of the food increases so does the cooking time. When cooking small amounts of food such as one or two potatoes, do not leave oven unattended. The moisture content in the food may decrease and a fire could result.

### Shape

Uniform sizes heat more evenly. The thin end of a drumstick will cook more quickly than the meaty end. To compensate for irregular shapes, place thin parts toward the center of the dish and thick pieces toward the edge.

### Size

Thin pieces cook more quickly than thick pieces.

### Starting Temperature

Foods that are room temperature take less time to cook than if they are chilled, refrigerated, or frozen.

## Cooking Techniques

### Piercing



Foods with skins or membranes must be pierced, scored or have a strip of skin peeled before cooking to allow steam to escape. Pierce whole egg yolks and whites, clams, oysters, chicken livers, whole potatoes and whole vegetables. Whole apples or new potatoes should have a 1-inch strip of skin peeled before cooking. Score sausages and frankfurters.

### Browning



Foods will not have the same brown appearance as conventionally cooked foods or those foods which are cooked utilizing a browning feature. Meats and poultry may be coated with browning sauce, Worcestershire sauce, barbecue sauce or shake-on browning sauce. To use, combine browning sauce with melted butter or margarine; brush on before cooking. For quick breads or muffins, brown sugar can be used in the recipe in place of granulated sugar, or the surface can be sprinkled with dark spices before baking.

# Cooking Techniques

## Spacing

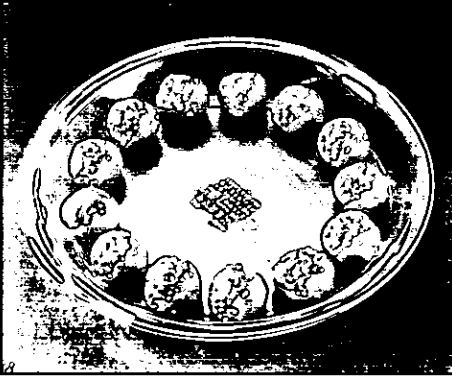

Individual foods, such as baked potatoes, cupcakes and appetizers, will cook more evenly if placed in the oven equal distances apart. When possible, arrange foods in a circular pattern.

## Covering

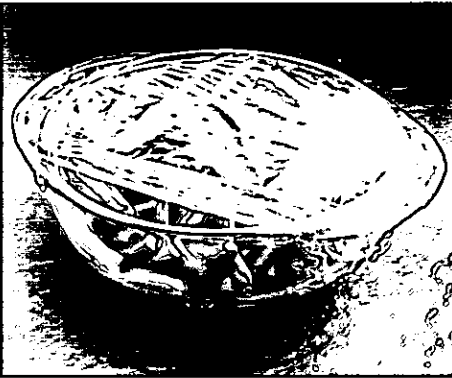

As with conventional cooking, moisture evaporates during microwave cooking. Casserole lids or plastic wrap are used for a tighter seal. When using plastic wrap, vent the plastic wrap by folding back part of the plastic wrap from the edge of the dish to allow steam to escape. Loosen or remove plastic wrap as recipe directs for stand time. When removing plastic wrap covers, as well as any glass lids, be careful to remove them away from you to avoid steam burns. Various degrees of moisture retention are also obtained by using wax paper or paper towels. However, unless specified, a recipe is cooked covered.

## Shielding

Thin areas of meat and poultry cook more quickly than meaty portions. To prevent overcooking, these thin areas can be shielded with strips of aluminum foil. Wooden toothpicks may be used to hold the foil in place.

## Timing

A range in cooking time is given in each recipe. The time range compensates for the uncontrollable differences in food shapes, starting temperature, and regional preferences. Always cook food for the minimum cooking time given in a recipe and check for doneness. If the food is undercooked, continue cooking. It is easier to add time to an undercooked product. Once the food is overcooked, nothing can be done.

## Stirring

Stirring is usually necessary during microwave cooking. We have noted when stirring is helpful, using the words once, twice, frequently, or occasionally to describe the amount of stirring necessary. Always bring the cooked outside edges toward the center and the less cooked center portions toward the outside of the dish.

## Rearranging

Rearrange small items such as chicken pieces, shrimp, hamburger patties, or pork chops. Rearrange pieces from the edge to the center and pieces from the center to the edge of the dish.

## Turning

It is not possible to stir some foods to redistribute the heat. At times, microwave energy will concentrate in one area of a food. To help insure even cooking, these foods need to be turned. Turn over large foods, such as roasts or turkeys, halfway through cooking.

## Stand Time

Most foods will continue to cook by conduction after the microwave oven is turned off. In meat cookery, the internal temperature will rise 5°F to 15°F (3°C to 8°C), if allowed to stand, tented with foil, for 10 to 15 minutes. Casseroles and vegetables need a shorter amount of standing time, but this standing time is necessary to allow foods to complete cooking to the center without overcooking on the edges.

## Test for Doneness

The same tests for doneness used in conventional cooking may be used for microwave cooking. Meat is done when fork-tender or splits at fibers. Chicken is done when juices are clear yellow and drumstick moves freely. Fish is done when it flakes and is opaque. Cake is done when a toothpick or cake tester is inserted and comes out clean. Candy is done when it reaches the proper temperature for each stage of crystallization.

## Care of Your Microwave Oven

### BEFORE CLEANING:

Unplug at socket of the oven. If impossible, leave oven door open to prevent oven from accidentally turning on.

### AFTER CLEANING:

Be sure to replace the Roller Ring and Glass Tray in the proper position and press **Stop/Reset** Pad to clear the display window.

#### Inside of the oven:

Wipe with a damp cloth. Mild detergent may be used if the oven gets very dirty. The use of harsh detergent or abrasives is not recommended.

#### Glass Tray:

Remove and wash in warm soapy water or in a dishwasher.

#### Outside oven surfaces.

Clean with a damp cloth. To prevent damage to the operating parts inside the oven, water should not be allowed to seep into ventilation openings.

#### Control Panel:

- \* Covered with a removable protective film to prevent scratches during shipping. Small bubbles may appear under this film. (Hint - To remove film, apply masking or clear tape to an exposed corner and pull gently.)
- \* If the Control Panel becomes wet, clean it with a soft dry cloth. Do not use harsh detergents or abrasives on the Control Panel.

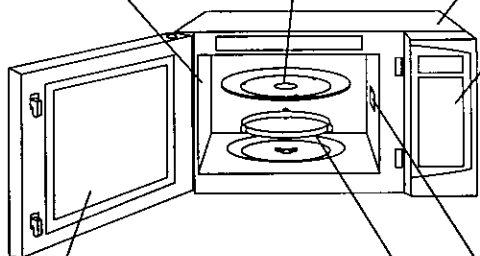

#### Oven Door:

Wipe with a soft cloth when steam accumulates inside or around the outside of the oven door. During cooking, especially under high humidity conditions, steam is given off from the food. (Some steam will condense on cooler surfaces, such as the oven door. This is normal.)

\* Inside surface is covered with a heat and vapour barrier film. Do not remove.

**Do not remove cover.**

#### Roller Ring and oven cavity floor:

Wipe the bottom surface of the oven with mild detergent water or window cleaner and dry. Roller Ring may be washed in mild soapy water or dishwasher. These areas should be kept clean to avoid excessive noise.

## ORDER FORM

### DESCRIPTION

### PART NUMBER

Instruction / Operating Manual (this book)  
Glass Tray  
Roller Ring Assembly

F00035L00AP  
F06014T00AP  
F290D9330AP

For pricing quotes, call or write the Parts & Literature Department at the phone or address listed below. Please have your credit card information readily available.

*Shipping & handling are not included. Price & availability subject to change. Sorry, no COD's.*

PANASONIC SERVICES COMPANY  
20421 84th Avenue South  
Kent, WA 98032

(800) 833-9626 - Phone  
(800) 237-9080 - FAX

You can purchase parts, accessories or locate your nearest servicer by visiting our Web Site:

**Web Site: <http://www.Panasonic.com>**

## Before Requesting Service

### All these things are normal:

The oven causes interference with my TV.

Some radio and TV interference might occur when you cook with the microwave oven. This interference is similar to the interference caused by small appliances such as mixers, vacuums, blow dryers, etc. It does not indicate a problem with your oven.

Steam accumulates on the oven door and warm air comes from the oven vents.

During cooking, steam and warm air are given off from the food. Most of the steam and warm air are removed from the oven by the air which circulates in the oven cavity. However, some steam will condense on cooler surfaces such as the oven door. This is normal.

I accidentally ran my microwave oven without any food in it.

Running the oven empty for a short time will not damage the oven. However, we do not recommend operating the microwave oven without any food in it.

PROBLEM	POSSIBLE CAUSE	REMEDY
Oven will not turn on.	The oven is not plugged in securely.	Remove plug from outlet, wait 10 seconds and reinsert.
	Circuit breaker or fuse is tripped or blown.	Reset circuit breaker or replace fuse.
	There is a problem with the outlet.	Plug another appliance into the outlet to check if it is working.
Oven will not start cooking.	The door is not closed completely.	Close the oven door securely.
	<b>Start</b> Pad was not pressed after programming.	Press <b>Start</b> Pad.
	Another program is already entered into the oven.	Press <b>Stop/Reset</b> Pad to cancel the previous program and enter new program.
	The program is not correct.	Program again according to the Operating Instructions.
When the oven is operating, there is noise coming from the glass tray.	<b>Stop/Reset</b> Pad has been pressed accidentally.	Program oven again.
	The Roller Ring and oven bottom are dirty.	Clean these parts according to <b>Care of Your Microwave Oven</b> .

## Limited Warranty & Customer Services Directory

PANASONIC CONSUMER ELECTRONICS COMPANY,  
DIVISION OF MATSUSHITA ELECTRIC  
CORPORATION OF AMERICA  
One Panasonic Way  
Secaucus, New Jersey 07094

PANASONIC SALES COMPANY,  
DIVISION OF MATSUSHITA  
ELECTRIC OF PUERTO RICO, INC.,  
Ave. 65 de Infanteria, Km. 9.5  
San Gabriel Industrial Park  
Carolina, Puerto Rico 00985

### Panasonic Microwave Oven Product Limited Warranty

#### Limited Warranty Coverage

If your product does not work properly because of a defect in materials or workmanship, Panasonic Consumer Electronics Company or Panasonic Sales Company (collectively referred to as "the warrantor") will, for the length of the period indicated on the chart below, which starts with the date of original purchase ("warranty period"), at its option either (a) repair your product with new or refurbished parts, or (b) replace it with a new or a refurbished product. The decision to repair or replace will be made by the warrantor.

	<b>PARTS</b>	<b>LABOR</b>
<b>ALL PARTS (EXCEPT MAGNETRON TUBE)</b>	<b>1 (ONE) YEAR</b>	<b>1 (ONE) YEAR</b>
<b>MAGNETRON TUBE</b>	<b>5 (FIVE) YEAR</b>	<b>1 (ONE) YEAR</b>

During the "Labor" warranty period there will be no charge for labor. During the "Parts" warranty period, there will be no charge for parts. You must carry-in or mail-in your product during the warranty period. This warranty only applies to products purchased and serviced in the United States or Puerto Rico. This warranty is extended only to the original purchaser of a new product which was not sold "as is". A purchase receipt or other proof of the original purchase date is required for warranty service.

#### Carry-In or Mail-In Service

For Carry-In or Mail-In Service in the United States call 1-800-211-PANA(7262) or visit Panasonic Web Site: <http://www.panasonic.com>

For assistance in Puerto Rico call Panasonic Sales Company (787)-750-4300 or fax (787)-768-2910.

#### Limited Warranty Limits And Exclusions

This warranty ONLY COVERS failures due to defects in materials or workmanship, and DOES NOT COVER glass, plastic parts, temperature probes (if included) and normal wear and tear or cosmetic damage. The warranty ALSO DOES NOT COVER damages which occurred in shipment, or failures which are caused by products not supplied by the warrantor, or failures which result from accidents, misuse, abuse, neglect, mishandling, misapplication, alteration, faulty installation, set-up adjustments, misadjustment of consumer controls, improper maintenance, power line surge, lightning damage, modification, or commercial use (such as in a hotel, office, restaurant, or other business), rental use of the product, service by anyone other than a Factory Servicenter or other Authorized Servicer, or damage that is attributable to acts of God.

**THERE ARE NO EXPRESS WARRANTIES EXCEPT AS LISTED UNDER "LIMITED WARRANTY COVERAGE". THE WARRANTOR IS NOT LIABLE FOR INCIDENTAL OR CONSEQUENTIAL DAMAGES RESULTING FROM THE USE OF THIS PRODUCT, OR ARISING OUT OF ANY BREACH OF THIS WARRANTY.** (As examples, this excludes damages for lost time, cost of having someone remove or re-install an installed unit if applicable, or travel to and from the servicer. The items listed are not exclusive, but are for illustration only.) **ALL EXPRESS AND IMPLIED WARRANTIES, INCLUDING THE WARRANTY OF MERCHANTABILITY, ARE LIMITED TO THE PERIOD OF THE LIMITED WARRANTY.**

Some states do not allow the exclusion or limitation of incidental or consequential damages, or limitations on how long an implied warranty lasts, so the exclusions may not apply to you.

This warranty gives you specific legal rights and you may also have others rights which vary from state to state. If a problem with this product develops during or after the warranty period, you may contact your dealer or Servicenter. If the problem is not handled to your satisfaction, then write to the warrantor's Consumer Affairs Department at the addresses listed for the warrantor.

**PARTS AND SERVICE WHICH ARE NOT COVERED BY THIS LIMITED WARRANTY ARE YOUR RESPONSIBILITY.**

#### Customer Services Directory

**For Product Information, Operating Assistance, Literature Request, Dealer Locations, and all Customer Service inquiries please contact:**  
**1-800-211-PANA (7262), Monday-Friday 9 am-9 pm; Saturday-Sunday 9 am-7 pm, EST.**

**Web Site: <http://www.panasonic.com>  
you can purchase parts, accessories or locate your  
nearest servicenter by visiting our Web Site.**

#### Accessory Purchases

1-800-332-5368 (Customer Orders Only)  
Panasonic Services Company 20421 84th Avenue South, Kent, WA 98032  
(6 am to 5 pm Monday-Friday; 6 am to 10:30 am Saturday; PST)  
(Visa, MasterCard, Discover Card, American Express, Check)

#### Service in Puerto Rico

**Matsushita Electric of Puerto Rico, Inc. Panasonic Sales Company/Factory Servicenter:  
Ave. 65 de Infanteria, Km. 9.5, San Gabriel Industrial Park, Carolina, Puerto Rico 00985  
Phone (787) 750-4300 Fax (787) 768-2910**