

This Owner's Manual is provided and hosted by [Appliance Factory Parts](#).



PANASONIC NN-SA646 Owner's Manual

[Shop genuine replacement parts for PANASONIC
NN-SA646](#)



[Find Your PANASONIC Microwave Parts - Select From 742 Models](#)

----- Manual continues below -----



Operating Instructions Microwave Oven

Models: NN-S654/S635/SA646

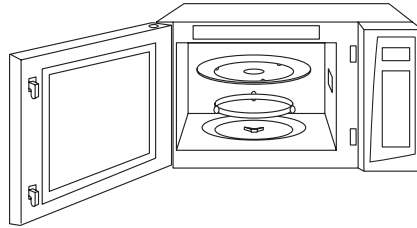
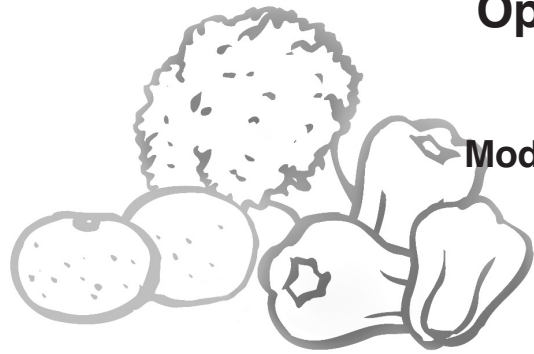

Safety Information

Precautions.....	Inside cover
Important Safety Instructions	1-3
Installation and Grounding Instructions	3-4
Safety Precautions	5-6

Operation

Control Panel.....	9
Starting to Use Your Oven.....	10
Setting the Clock	10
Child Safety Lock	10
Selecting Power & Cook Time.....	11
Quick Min Feature	11
Keep Warm Feature	11
Popcorn Feature.....	12
More/Less Feature	12
Inverter Turbo Defrost Feature	13
Defrosting Tips & Techniques.....	13-14
Auto Reheat Feature	15
Auto Cook Feature	15
Auto Cook Chart.....	16

Operation

Timer Feature (Kitchen Timer/Stand Time/Delay Start).....	17
Microwave Shortcuts	18-19
Food Characteristics.....	20
Cooking Techniques	20-21
Quick Guide to Operation.....	25

Maintenance

Care and Cleaning of Your Microwave Oven	22
Accessory Purchases	22
Before Requesting Service.....	23
Limited Warranty & Customer Service Directory	24

General Information

Cookware Guide.....	7
Oven Components Diagram.....	8
Specifications	26
User's Record.....	26

READ ALL INSTRUCTIONS CAREFULLY BEFORE USING THE OVEN.

Para instrucciones en español, voltee el libro.

For assistance, please call: 1-800-211-PANA(7262)
or send e-mail to: consumerproducts@panasonic.com
or visit us at www.panasonic.com

(U.S.A)

For assistance, please call: 787-750-4300
or visit us at www.panasonicpr.com

(Puerto Rico)

F00036K82AP
iPress0106-5
Printed in China

Microwave Oven Safety

Your safety and the safety of others are very important.

We have provided important safety messages in this manual and on your appliance. Always read and obey all safety messages.



This is the safety alert symbol. It is used to alert you to potential hazards that can kill or hurt you and others.

All safety messages will follow the safety alert symbol and either the word "DANGER", "WARNING" or "CAUTION". These words mean:

DANGER

You can be killed or seriously injured if you don't immediately follow instructions.

WARNING

You can be killed or seriously injured if you don't follow instructions.

CAUTION

You can be exposed to a potentially hazardous situation which, if not avoided, may result in minor or moderate injury.

All safety messages will tell you what the potential hazard is, tell you how to reduce the chance of injury, and tell you what can happen if the instructions are not followed.



PRECAUTIONS TO AVOID POSSIBLE EXPOSURE TO EXCESSIVE MICROWAVE ENERGY

- (a) Do not attempt to operate this oven with the door open since open-door operation can result in harmful exposure to microwave energy. It is important not to defeat or tamper with the safety interlocks.
- (b) Do not place any object between the oven front face and the door or allow soil or cleaner residue to accumulate on sealing surfaces.
- (c) Do not operate the oven if it is damaged. It is particularly important that the oven door close properly and that there is no damage to the:
 - (1) door (bent),
 - (2) hinges and latches (broken or loosened),
 - (3) door seals and sealing surfaces.
- (d) The oven should not be adjusted or repaired by anyone except properly qualified service personnel.

Thank you for purchasing a Panasonic Microwave Oven.

Your microwave oven is a cooking appliance and you should use as much care as you use with a stove or any other cooking appliance. When using this electric appliance, basic safety precautions should be followed, including the following:

IMPORTANT SAFETY INSTRUCTIONS

WARNING

—To reduce the risk of burns, electric

shock, fire, injury to persons, or exposure to excessive microwave energy:

1. Read all instructions before using this appliance.
2. Read and follow the specific “PRECAUTIONS TO AVOID POSSIBLE EXPOSURE TO EXCESSIVE MICROWAVE ENERGY,” found on the inside front cover.
3. This appliance must be grounded. Connect only to a properly grounded outlet. See “GROUNDING INSTRUCTIONS” found on page 4.
4. As with any cooking appliance, **DO NOT** leave oven unattended while in use.
5. Install or locate this appliance only in accordance with the installation instructions found on page 3.
6. **DO NOT** cover or block any openings on this appliance.
7. **DO NOT** store this appliance outdoors. **DO NOT** use this product near water—for example, near a kitchen sink, in a wet basement, or near a swimming pool or similar locations.
8. Use this appliance only for its intended use as described in this manual. **DO NOT** use corrosive chemicals, vapors, or non-food products in this appliance. This type of oven is specifically designed to heat, or cook food. It is not designed for industrial or laboratory use. The use of corrosive chemicals in heating or cleaning will damage the appliance and may result in radiation leaks.
9. When cleaning surfaces of the door and oven that come together on closing the door, use only mild, non-abrasive soaps or detergents applied with a sponge or soft cloth.
10. **DO NOT** allow children to use this appliance, unless closely supervised by an adult. **DO NOT** assume that because a child has mastered one cooking skill he/she can cook everything.
11. **DO NOT** operate this appliance if it has a damaged cord or plug, if it is not working properly, or if it has been damaged or dropped.
12. **DO NOT** immerse cord or plug in water.
13. Keep cord away from heated surfaces.
14. **DO NOT** let cord hang over edge of a table or counter.
15. This appliance should be serviced only by qualified service personnel. Contact the nearest authorized service center for examination, repair or adjustment.
16. Some products such as whole eggs with or without shell, narrow neck bottles and sealed containers—for example, closed glass jars—may explode and should not be heated in this oven.
17. To reduce the risk of fire in the oven cavity:
 - (a) Do not overcook food. Carefully attend appliance when paper, plastic, or other combustible materials are placed inside the oven to facilitate cooking.
 - (b) Remove wire twist-ties from paper or plastic bags before placing bag in oven.
 - (c) **If material inside the oven ignites, keep oven door closed, turn oven off, and disconnect the power cord, or shut off power at the fuse or circuit breaker panel.**
 - (d) **DO NOT** use the cavity for storage purposes. **DO NOT** leave paper products, cooking utensils or food in the cavity when not in use.

! IMPORTANT SAFETY INSTRUCTIONS

(continued)

18. Superheated Liquids

Liquids, such as water, coffee, or tea are able to be overheated beyond the boiling point without showing evidence (or signs) of boiling. Visible bubbling is not always present when the container is removed from the microwave oven. THIS COULD RESULT IN VERY HOT LIQUIDS SUDDENLY BOILING OVER WHEN THE CONTAINER IS DISTURBED OR A UTENSIL IS INSERTED INTO THE LIQUID.

To reduce the risk of injury to persons:

- (a) **STIR THE LIQUID BOTH BEFORE AND HALFWAY THROUGH HEATING IT.**
- (b) **Do not heat water and oil, or fats together. The film of oil will trap steam, and may cause a violent eruption.**
- (c) Do not use straight-sided containers with narrow necks.
- (d) After heating, allow the container to stand in the microwave oven for a short time before removing the container.

19. **DO NOT** cook directly on the turntable. It can crack, and cause injury or damage to the oven.

! WARNING

TO AVOID THE RISK OF SHOCK:

DO NOT remove outer panel from oven. Repairs must be done only by a qualified service person.

TO REDUCE THE RISK OF EXPOSURE TO MICROWAVE ENERGY:

DO NOT tamper with, or make any adjustments or repairs to Door, Control Panel Frame, Safety Interlock Switches, or any other part of oven, microwave leakage may result.

TO AVOID THE RISK OF FIRE:

1. **DO NOT** operate the oven empty. The microwave energy will reflect continuously throughout the oven causing overheating and damage, if food or water is not present to absorb energy.
2. **DO NOT** store flammable materials next to, on top of, or in the oven.
3. **DO NOT** dry clothes, newspapers or other materials in the oven, or use newspaper or paper bags for cooking.
4. **DO NOT** hit or strike Control Panel. Damage to controls may occur.
5. **DO NOT** use recycled paper products unless the paper product is labeled as safe for microwave oven use. Recycled paper products may contain impurities which may cause sparking.

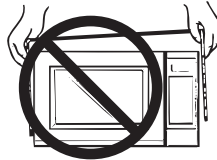

TO AVOID THE RISK OF SCALDING:

POT HOLDERS should always be used when removing items from the oven. Heat is transferred from the HOT food to the cooking container and from the container to the Glass Tray. The Glass Tray can also be very HOT after removing the cooking container from the oven.

SAVE THESE INSTRUCTIONS

For proper use of your oven read remaining safety cautions and operating instructions.

IMPORTANT SAFETY INSTRUCTIONS

(continued)

Glass Tray

1. **DO NOT** operate the oven without the Roller Ring and the Glass Tray in place.
2. **DO NOT** operate the oven without the Glass Tray fully engaged on the drive hub. Improper cooking or damage to the oven could result. Verify that the Glass Tray is properly engaged and rotating by observing its rotation when you press Start. **Note:** The Glass Tray can turn in either direction.
3. Use only the Glass Tray specifically designed for this oven. **DO NOT** substitute any other glass tray.
4. If the Glass Tray is hot, allow to cool before cleaning or placing in water.
5. **DO NOT** cook directly on the Glass Tray. Always place food in a microwave safe dish, or on a rack set in a microwave safe dish.
6. If food or utensil on the Glass Tray touches oven walls, causing the tray to stop moving, the tray will automatically rotate in the opposite direction.

Roller Ring

1. The Roller Ring and oven floor should be cleaned frequently to prevent excessive noise.
2. Always replace the Roller Ring and the Glass Tray in their proper positions.
3. The Roller Ring must always be used for cooking along with the Glass Tray.

INSTALLATION AND GROUNDING INSTRUCTIONS

Examine Your Oven

Unpack oven, remove all packing material and examine the oven for any damage such as dents, broken door latches or cracks in the door. Notify dealer immediately if oven is damaged. **DO NOT** install if oven is damaged.

Placement of Oven

1. The oven must be placed on a flat, stable surface. Place the front surface of the door three inches or more from the counter top edge to avoid accidental tipping of the microwave oven during normal use. For proper operation, the oven must have sufficient air flow. Allow 3-inches (7.6 cm) of space on both sides of the oven and 1-inch (2.5 cm) of space on top of the oven.
 - (a) **DO NOT** block air vents. If they are blocked during operation, the oven may be overheated and damaged.
 - (b) **DO NOT** place oven near a hot, damp surface such as a gas or electric range, or dishwasher.
 - (c) **DO NOT** operate oven when room humidity is excessive.
2. This oven is manufactured for counter top household use only. It is not intended for built-in operation and is not approved or tested for mobile vehicle, marine, or commercial use.

Installation

DO NOT block air vents. If they are blocked during operation, the oven may overheat. If the oven overheats, a thermal safety device will turn the oven off. The oven will remain inoperable until it has cooled.

INSTALLATION AND GROUNDING INSTRUCTIONS (continued)

WARNING —IMPROPER USE OF THE GROUNDING PLUG CAN RESULT IN A RISK OF ELECTRIC SHOCK.

Consult a qualified electrician or service person if the grounding instructions are not completely understood, or if doubt exists as to whether the appliance is properly grounded. If it is necessary to use an extension cord, use only a three wire extension cord that has a three prong polarized grounding plug, and a three slot receptacle that will accept the plug on the appliance. The marked rating of the extension cord should be equal to or greater than the electrical rating of the appliance.

Grounding Instructions

THIS APPLIANCE MUST BE GROUNDED. In the event of an electrical short circuit, grounding reduces the risk of electric shock by providing an escape wire for the electric current. This appliance is equipped with a cord having a grounding wire with a grounding plug. The plug must be plugged into an outlet that is properly installed and grounded.

- **Plug into properly installed and grounded 3 prong outlet.**
- **DO NOT remove ground prong.**
- **DO NOT use an adapter.**

Power Supply

1. A short power-supply cord is provided to reduce the risks resulting from becoming entangled in or tripping over a longer cord.
2. Longer cord sets or extension cords are available and may be used if care is exercised in their use. **Do not** let cord hang over edge of a table or counter.
3. If a long cord or extension cord is used, (1) the marked electrical rating of the cord set or extension cord should be at least as great as the electrical rating of the appliance, (2) the extension cord must be a grounding-type 3-wire cord, and (3) the longer cord should be arranged so that it will not drape over the counter top or table-top where it can be pulled on by children or tripped over accidentally.

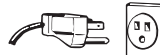

Wiring Requirements

The oven must be operated on a SEPARATE CIRCUIT. No other appliance should share the circuit with the microwave oven. If it does, the branch circuit fuse may blow or the circuit breaker may trip. The oven must be plugged into at least a 20 AMP, 120 VOLT, 60 Hz GROUNDED OUTLET. Where a standard two-prong outlet is encountered, it is the personal responsibility and obligation of the consumer to have it replaced with a properly grounded three-prong outlet. The VOLTAGE used must be the same as specified on this microwave oven (120 V, 60 Hz). Using a higher voltage is dangerous and may result in a fire or oven damage. Using a lower voltage will cause slow cooking. Panasonic is NOT responsible for any damages resulting from the use of the oven with any voltage other than specified.

TV / Radio Interference

1. Operation of the microwave oven may cause interference to your radio, TV or similar equipment.
2. When there is interference, it may be reduced or eliminated by taking the following measures:
 - (a) Place the radio, TV, etc. away from the microwave oven as far as possible.
 - (b) Use a properly installed antenna to obtain stronger signal reception.
 - (c) Clean door and sealing surfaces of the oven. (See Care and Cleaning of Your Microwave Oven)



Safety Precautions

Follow These Safety Precautions When Cooking in Your Oven.

IMPORTANT

Proper cooking depends upon the power, the time setting and quantity of food. If you use a smaller portion than recommended but cook at the time for the recommended portion, fire could result.

1) HOME CANNING / STERILIZING / DRYING FOODS / SMALL QUANTITIES OF FOODS

- **DO NOT** use your oven for home canning. Your oven cannot maintain the food at the proper canning temperature. The food may be contaminated and then spoil.
- **DO NOT** use the microwave oven to sterilize objects (baby bottles, etc.). It is difficult to keep the oven at the high temperature needed for sterilization.
- **DO NOT** dry meats, herbs, fruits or vegetables in your oven. Small quantities of food or foods with low moisture content can dry out, scorch or catch on fire if overheated.

2) POPCORN

Popcorn may be popped in a microwave oven corn popper. Microwave popcorn which pops in its own package is also available. Follow popcorn manufacturers' directions and use a brand suitable for the cooking power of your microwave oven.

CAUTION: When using pre-packaged microwave popcorn, you can follow recommended package instructions or use the popcorn pad (refer to page 12). Otherwise, the popcorn may not pop adequately or may ignite and cause a fire. Never leave oven unattended when popping popcorn. Allow the popcorn bag to cool before opening, always open the bag facing away from your face and body to prevent steam burns.

3) DEEP FAT FRYING

- **DO NOT** deep fat fry in your microwave oven. Cooking oils may burst into flames and may cause damage to the oven and perhaps result in burns. Microwave utensils may not withstand the temperature of the hot oil, and can shatter or melt.

4) FOODS WITH NONPOROUS SKINS

- **DO NOT COOK/REHEAT WHOLE EGGS, WITH OR WITHOUT THE SHELL.** Steam buildup in whole eggs may cause them to explode, and possibly damage the oven or cause injury. Reheating SLICED hard-boiled eggs and cooking SCRAMBLED eggs is safe.
 - **Potatoes, apples, whole squash and sausages** are examples of foods with non-porous skins. These types of foods must be pierced before microwave cooking to prevent them from exploding.
- CAUTION:** Cooking dry or old potatoes can cause fire.



Safety Precautions

(continued)

5) GLASS TRAY / COOKING CONTAINERS / FOIL

- Cooking containers get hot during microwaving. Heat is transferred from the HOT food to the container and the Glass Tray. Use pot holders when removing containers from the oven or when removing lids or plastic wrap covers from cooking containers, to avoid burns.
- The Glass Tray will get hot during cooking. It should be allowed to cool before handling or before paper products, such as paper plates or microwave popcorn bags, are placed in the oven for microwave cooking.
- When using foil in the oven, allow at least 1-inch (2.5 cm) of space between foil and interior oven walls or door.
- Dishes with metallic trim should **not** be used, as arcing may occur.

6) PAPER TOWELS / CLOTHS

- **DO NOT** use paper towels or cloths which contain a synthetic fiber woven into them. The synthetic fiber may cause the towel to ignite. Use paper toweling under supervision.

7) BROWNING DISHES / OVEN COOKING BAGS

- Browning dishes or grills are designed for microwave cooking only. Always follow instructions provided by the manufacturer. **DO NOT** preheat browning dish more than 6 minutes.
- If an oven cooking bag is used for microwave cooking, prepare according to package directions. **DO NOT** use a wire twist-tie to close bag, instead use plastic ties, cotton string or a strip cut from the open end of the bag.

8) THERMOMETERS

- **DO NOT** use a conventional meat thermometer in your oven. Arcing may occur. Microwave safe thermometers are available for both meat and candy.

9) BABY FORMULA / BABY FOOD

- **DO NOT** heat baby formula or baby food in the microwave oven. The glass jar or surface of the food may appear warm while the interior can be so hot as to burn the infant's mouth and esophagus.

10) REHEATING PASTRY PRODUCTS

- When reheating pastry products, check temperatures of any fillings before eating. Some foods have fillings which heat faster and can be extremely hot, while the surface remains warm to the touch (ex. Jelly Donuts).

11) GENERAL OVEN USAGE GUIDELINES

- **DO NOT** use the oven for any purpose other than the preparation of food.



Cookware Guide

ITEM	MICROWAVE	COMMENTS
Aluminum Foil	Yes for Shielding only	Small strips of foil can be molded around thin parts of meat or poultry to prevent overcooking. Arcing can occur if foil is too close to oven wall or door and damage to your oven will result.
Browning Dish	Yes	Browning dishes are designed for microwave cooking only. Check browning dish information for instructions and heating chart. Do not preheat for more than 6 minutes.
Brown paper bags	No	May cause a fire in the oven.
Dinnerware: Labeled "Microwave Safe"	Yes	Check manufacturers' use and care directions for use in microwave heating. Some dinnerware may state on the back of the dish, "Oven-Microwave Safe".
Unlabeled Dinnerware	?	Use CONTAINER TEST below.
Disposable polyester Paperboard Dishes	Yes	Some frozen foods are packaged in these dishes. Can be purchased in grocery stores.
Fast Food Carton with Metal Handle	No	Metal handle may cause arcing.
Frozen Dinner Tray Metal	No	Metal can cause arcing and damage to your oven.
Frozen Dinner Tray Microwave safe	Yes	Heat only 1 tray in the oven at one time.
Glass Jars	No	Most glass jars are not heat resistant. Do not use for cooking or reheating.
Heat Resistant Oven Glassware & Ceramics	Yes	Ideal for microwave cooking and browning. (See CONTAINER TEST below)
Metal Bakeware	No	Not recommended for use in microwave ovens. Metal can cause arcing and damage to your oven.
Metal Twist-Ties	No	May cause arcing which could cause a fire in the oven.
Oven Cooking Bag	Yes	Follow manufacturers' directions. Close bag with the nylon tie provided, a strip cut from the end of the bag, or a piece of cotton string. Do not close with metal twist-tie. Make six 1/2-inch (1 cm) slits near the closure.
Paper Plates & Cups	Yes	Use to warm cooked foods, and to cook foods that require short cooking times such as hot dogs.
Paper Towels & Napkins	Yes	Use to warm rolls and sandwiches, only if labeled safe for microwave use.
Recycled Paper Towels & Napkins	No	Recycled paper products may contain impurities which may cause sparks.
Parchment Paper	Yes	Use as a cover to prevent spattering. Safe for use in microwave, microwave/convection and conventional ovens.
Plastic: Microwave Safe Cookware	Yes, use caution	Should be labeled, "Suitable for Microwave Heating." Check manufacturers' directions for recommended uses. Some microwave safe plastic containers are not suitable for cooking foods with high fat or sugar content. The heat from hot food may cause the plastic to warp.
Plastic, Melamine	No	This material absorbs microwave energy. Dishes get HOT!
Plastic Foam Cups	Yes, use caution	Plastic foam will melt if foods reach a high temperature. Use to reheat foods to a low serving temperature only.
Plastic Wrap	Yes	Use to cover food during cooking to retain moisture and prevent spattering. Should be labeled "Suitable for Microwave Heating". Check package directions.
Straw, Wicker, Wood	Yes, use caution	Use only for short term reheating and to bring food to a low serving temperature. Wood may dry out & split or crack when used.
Thermometers- Microwave safe	Yes	Use only microwave safe meat and candy thermometers.
Thermometers- Conventional	No	Not suitable for use in microwave oven, will cause sparks and get hot.
Wax paper	Yes	Use as a cover to prevent spattering and to retain moisture.

CONTAINER TEST

TO TEST A CONTAINER FOR SAFE MICROWAVE OVEN USE: Fill a microwave safe cup with cool water and place it in the microwave oven alongside the empty container to be tested; **heat one (1) minute at P10 (HIGH)**. If the container is microwave oven safe (transparent to microwave energy), the empty container should remain comfortably cool and the water should be hot. If the container is hot, it has absorbed some microwave energy and should NOT be used. This test cannot be used for plastic containers.

Oven Components Diagram

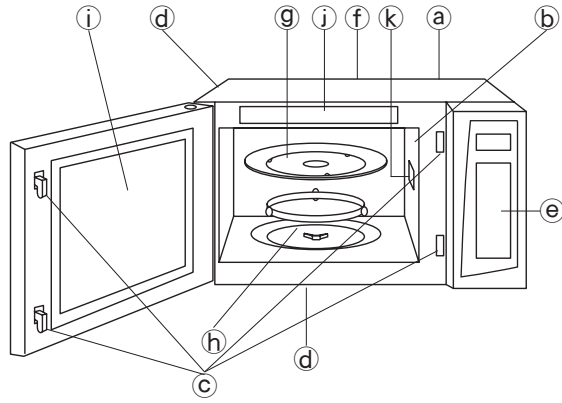

- Ⓐ External Air Vent
- Ⓑ Internal Air Vent
- Ⓒ Door Safety Lock System
- Ⓓ Exhaust Air Vent
- Ⓔ Control Panel
- Ⓕ Identification Plate
- Ⓖ Glass Tray
- Ⓗ Roller Ring
- Ⓘ Heat/Vapor Barrier Film
(do not remove)
- ⓵ Menu Label
- Ⓚ Waveguide Cover (do not remove)

Oven Light:

Oven Light turns on only while cooking and will not turn on when oven door is opened.

Control Panel

NN-S654

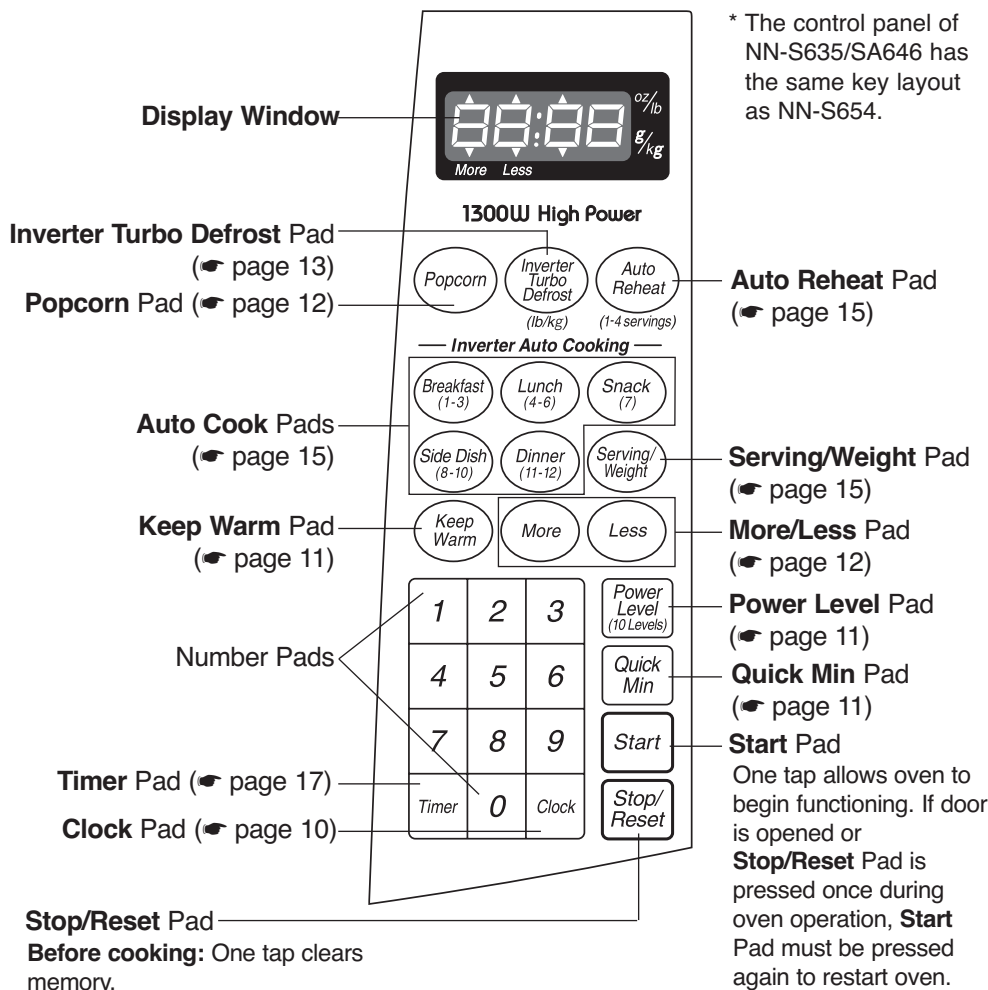

* The control panel of NN-S635/SA646 has the same key layout as NN-S654.





Stop/Reset Pad
Before cooking: One tap clears memory.

During cooking: One tap temporarily stops the cooking process. Another tap cancels all your instructions and time of day or colon appears in the **Display Window**.

Beep Sound:

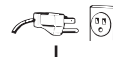
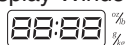

When a pad is pressed correctly, a beep will be heard. If a pad is pressed and no beep is heard, the unit did not or cannot accept the instruction. When operating, the oven will beep twice between programmed stages. At the end of any complete program, the oven will beep 5 times.

Starting to Use Your Oven!

<p>1. </p> <p>Display Window</p> 	<ul style="list-style-type: none"> • Plug into a properly grounded electrical outlet. The oven automatically defaults to the imperial measure system (oz/lb).
<p>2. If you wish to use metric system (g/kg):</p> <p></p> <p>↓</p>  <p>↙ ↘</p> 	<ul style="list-style-type: none"> • Press Start to convert to metric. Verify your selection in the display window.
<p>3. </p>	<ul style="list-style-type: none"> • Press Stop/Reset. <ul style="list-style-type: none"> ▶ Colon appears in the display window.

Child Safety Lock



This feature prevents the electronic operation of the oven until cancelled. It does not lock the door.

<p>To Set:</p> 	<ul style="list-style-type: none"> • Press Start 3 times. "Child" appears in the display window. <ul style="list-style-type: none"> ▶ "Child" continues to be displayed until Child Lock is cancelled. Keypads may be pressed but the microwave will not start.
<p>To Cancel:</p> 	<ul style="list-style-type: none"> • Press Stop/Reset 3 times. <ul style="list-style-type: none"> ▶ The display will return to colon or time of day when Child Lock has been cancelled.

NOTE: You can set Child Lock feature when the display shows a colon or time of day.

Setting the Clock

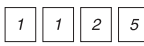

Example: To set 11:25 a.m. or p.m.

<p>1. </p>	<ul style="list-style-type: none"> • Press Clock once. <ul style="list-style-type: none"> ▶ Colon flashes.
<p>2. </p>	<ul style="list-style-type: none"> • Enter time of day using the number pads. <ul style="list-style-type: none"> ▶ Time appears in the display window; colon continues flashing.
<p>3. </p>	<ul style="list-style-type: none"> • Press Clock. <ul style="list-style-type: none"> ▶ Colon stops flashing; time of day is entered.

- NOTES:**
1. To reset the clock, repeat step 1-3.
 2. The clock will retain the time of day as long as the oven is plugged in and electricity is supplied.
 3. Clock is a 12 hour display.
 4. Oven will not operate while colon is flashing.

Selecting Power & Cook Time

Example: To cook at P 6 (MEDIUM) power for 1 minute 30 seconds

1.  Press 5 times.	• Press Power Level until the desired power level appears in the display window.
2. 	• Set Cooking Time using number pads.
3. 	• Press Start . ▶ Cooking will start. The time in the display window will count down.

Press	Power Level
once	P10 (HIGH)
twice	P9
3 times	P8
4 times	P7 (MEDIUM-HIGH)
5 times	P6 (MEDIUM)
6 times	P5
7 times	P4
8 times	P3 (MEDIUM-LOW)/DEFROST
9 times	P2
10 times	P1 (LOW)

NOTES:



- For more than one stage cooking, repeat steps 1 and 2 for each stage of cooking before pressing **Start** Pad. The maximum number of stages for cooking is 5. When operating, two beeps will sound between each stage. Five beeps will sound at the end of the entire sequence.
- When selecting P10 (HIGH) power for the first stage, you may begin at step 2.
- When selecting P10 (HIGH) power, the maximum programmable time is 30 minutes. For other power levels, the maximum time is 99 minutes and 99 seconds.
- For reheating, use P10 (HIGH) for liquids, P7 (MEDIUM-HIGH) for most foods and P6 (MEDIUM) for dense foods.
- For defrosting, use P3 (MEDIUM-LOW).

DO NOT OVER COOK. This oven requires less time to cook than an older unit. Over cooking will cause food to dry out and may cause a fire. A microwave oven's cooking power tells you the amount of microwave power available for cooking.

Quick Min Feature

This feature allows you to set or add cooking time in 1 minute increments up to 10 minutes.

To Set Cooking Time:

1. 	• Press Quick Min until the desired cooking time (up to 10 minutes) appears in the display window. Power Level is pre-set at P10.
2. 	Press Start . Cooking begins and the time will count down. At the end of cooking, 5 beeps sound.



NOTES:

- If desired, you can use other power levels. Select desired power level before setting cooking time.
- After setting the time by **Quick Min** Pad, you cannot use Number Pads.
- Quick Min** Pad can be used to add more time during manual cooking.

Keep Warm Feature

This feature will keep food warm for up to 30 minutes after cooking.

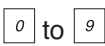
Example: To keep 2 cups of gravy warm

1. 	• Press Keep Warm .
2. 	• Set warming time, up to 30 minutes.
3. 	• Press Start . ▶ Keep Warm will start. The time in the display window will count down.





NOTE:

Keep Warm can be programmed as the final stage after cook time/s have been manually entered. It cannot be used in combination with sensor or auto features.



Popcorn Feature

Example: To pop 3.5 oz. of popcorn

<p>1.</p>  <p>Press once</p>	<p>• Press Popcorn until the desired size appears in the display window.</p> <table border="1" data-bbox="231 280 486 380"> <thead> <tr> <th>Press</th> <th>Weight</th> </tr> </thead> <tbody> <tr> <td>once</td> <td>3.5 oz (99 g)</td> </tr> <tr> <td>twice</td> <td>3.0 oz (85 g)</td> </tr> <tr> <td>3 times</td> <td>1.75 oz (50 g)</td> </tr> </tbody> </table>	Press	Weight	once	3.5 oz (99 g)	twice	3.0 oz (85 g)	3 times	1.75 oz (50 g)
Press	Weight								
once	3.5 oz (99 g)								
twice	3.0 oz (85 g)								
3 times	1.75 oz (50 g)								
<p>2.</p>  or  <p>Optional</p>	<p>(see More/Less Feature.)</p>								
<p>3.</p> 	<p>• Press Start . ► After several seconds, cooking time appears in the display window and begins to count down.</p>								

NOTES ON POPCORN FEATURE:

1. Pop one bag at a time.
2. Place bag in oven according to manufacturers' directions.
3. Start with popcorn at room temperature.
4. Allow popped corn to sit unopened for a few minutes.
5. Open bag carefully to prevent burns, because steam will escape.
6. Do not reheat unpopped kernels or reuse bag.

NOTE:

If popcorn is of a different weight than listed, follow instructions on popcorn package. **Never leave the oven unattended.** If popping slows to 2 to 3 seconds between pops, stop oven. **Overcooking can cause fire.**

REMARKS:

When popping multiple bags one right after the other, the cooking times may vary slightly. This does not affect the popcorn results.



More/Less Feature

For Popcorn:

By using the **More/Less** Pad, the programs can be adjusted to cook popcorn for a longer or shorter time if desired.

 : Adds time

 : Subtracts time

More 2 = Adds Approx. 20 secs.

More 1 = Adds Approx. 10 secs.

original setting

Less 1 = Subtracts Approx. 10 secs.

Less 2 = Subtracts Approx. 20 secs.

Press **More/Less** pad before pressing **Start**.

For Auto Reheat/Cook:

Preferences for food doneness vary with each individual. After having used the **Auto Reheat/Cook** feature a few times, you may decide you would prefer your food cooked to a different doneness.

 : Adds time

 : Subtracts time

More 1 = Adds Approx. 10% time

original setting

Less 1 = Subtracts Approx. 10% time

Press **More/Less** pad before pressing **Start**.





Inverter Turbo Defrost Feature

This feature allows you to defrost foods such as: meat, poultry and seafood simply by entering the weight.

Example: To defrost 1.5 pounds of meat

Place food on microwave safe dish.

1. 	• Press Inverter Turbo Defrost .
2. 	• Enter weight of the food using the number pads.
3. 	• Press Start . Defrosting will start. The time will count down. Larger weight foods will cause a signal midway through defrosting. If 2 beeps sound, turn over, rearrange foods or shield with aluminum foil.

Conversion Chart:

Follow the chart to convert ounces or hundredths of a pound into tenths of a pound. To use Inverter Turbo Defrost, enter the weight of the food in lbs. (1.0) and tenths of a lb. (0.1). If a piece of meat weighs 1.95 lbs. or 1 lb. 14 oz., enter 1.9 lbs.

Ounces	Hundredths of a Pound	Tenths of a Pound
0	.01 - .05	0.0
1 - 2	.06 - .15	0.1
3 - 4	.16 - .25	0.2
5	.26 - .35	0.3
6 - 7	.36 - .45	0.4
8	.46 - .55	0.5
9 - 10	.56 - .65	0.6
11 - 12	.66 - .75	0.7
13	.76 - .85	0.8
14 - 15	.86 - .95	0.9



Defrosting Tips & Techniques

Preparation For Freezing:

1. Freeze meats, poultry, and fish in packages with only 1 or 2 layers of food. Place wax paper between layers.
2. Package in heavy-duty plastic wraps, bags (labeled "For Freezer"), or freezer paper.
3. Remove as much air as possible.
4. Seal securely, date, and label.

To Defrost:

1. Remove wrapper. This helps moisture to evaporate. Juices from food can get hot and cook the food.
2. Set food in microwave safe dish.
3. Place roasts fat-side down. Place whole poultry breast-side down.
4. Select power and minimum time so that items will be under-defrosted.
5. Drain liquids during defrosting.
6. Turn over (invert) items during defrosting.
7. Shield edges and ends if needed. (See Cooking Techniques).

After Defrosting:

1. Large items may be icy in the center. Defrosting will complete during STANDING TIME.
2. Let stand, covered, following stand time directions on page 14.
3. Rinse foods indicated in the chart.
4. Items which have been layered should be rinsed separately or have a longer stand time.



Defrosting Tips & Techniques (continued)





FOOD	DEFROST TIME at P3 mins (per lb)	DURING DEFROSTING	AFTER DEFROSTING	
			Stand Time	Rinse
Fish and Seafood [up to 3 lbs. (1.4 kg)]				
Crabmeat	6	Break apart/Rearrange	5 min.	YES
Fish Steaks	4 to 6	Turn over		
Fish Fillets	4 to 6	Turn over/Rearrange/Shield ends		
Sea Scallops	4 to 6	Break apart/Remove defrosted pieces		
Whole fish	4 to 6	Turn over		
Meat				
Ground Meat	4 to 5	Turn over/Remove defrosted portion/Shield edges	10 min.	NO
Roasts [2½-4 lbs. (1.1-1.8 kg)]	4 to 8	Turn over/Shield ends and defrosted surface	30 min. in refrig.	
Chops/Steak	6 to 8	Turn over/Rearrange/Shield ends and defrosted surface	5 min.	
Ribs/T-bone	6 to 8	Turn over/Rearrange/Shield ends and defrosted surface		
Stew Meat	4 to 8	Break apart/Rearrange/Remove defrosted pieces		
Liver (thinly sliced)	4 to 6	Drain liquid/Turn over/Separate pieces		
Bacon (sliced)	4	Turn over	- - - -	
Poultry				
Chicken, Whole [up to 3 lbs. (1.4 kg)]	4 to 6	Turn over/Shield	20 min. in refrig.	YES
Cutlets	4 to 6	Break apart/Turn over/Remove defrosted Pieces	5 min.	
Pieces	4 to 6	Break apart/Turn over/Shield	10 min.	
Cornish Hens	6 to 8	Turn over/Shield	20 min. in refrig.	
Turkey Breast [5-6 lbs. (2.3-2.7 kg)]	6	Turn over/Shield		



Auto Reheat Feature

This feature allows you to reheat 1 to 4 servings of cooked, refrigerated food without setting power and time.

Example: To reheat 2 servings of casserole

1.  Press twice	• Press Auto Reheat until the desired number of servings appears in the display window.
2.  or  Optional	(see More/Less Feature) (☛page 12)
3. 	• Press Start . ► Cooking begins and the time will count down.

Press Auto Reheat pad to indicate number or servings	Average Serving Size	Time
once	4-6 oz.	will vary depending on size and wattage of oven
twice	8 oz.	
3 times	12 oz.	
4 times	16 oz.	

NOTES: For best results, follow these recommendations:





1. All foods must be previously cooked.
2. Foods should always be covered loosely with plastic wrap, wax paper or casserole lid.
3. All foods should have a covered stand time of 3 to 5 minutes.
4. **DO NOT** reheat bread and pastry products using Auto Reheat. Use manual power and time instead.
5. **DO NOT** reheat beverages.
6. Times are based on an approximate serving size of 4 oz.
7. A plate of food is normally 3-4 servings.



Auto Cook Feature

These are tested and pre-timed (based on the power rating of this oven) for the quantity of food listed in the chart on page 16. Locale, power fluctuations and personal tastes are not taken into account. Should you prefer your food cooked differently, use power and time method shown on page 11.

Example: To cook a 10 oz. Frozen Entrées

1.  Press 3 times	• Press until the desired food number appears in the display window.
2.  Press twice	• Press Serving/Weight until the desired serving/weight appears in the display window.
3.  or  Optional	(see More/Less Feature) (☛page 12)
4. 	• Press Start . ► Cooking begins and the time will count down.



Auto Cook Chart

Pad	Recipe	Serving/Weight	Hints
Breakfast	1. Oatmeal	0.5, 1 cup (40, 80 g)	Place inside a microwave safe serving bowl with no cover. Follow manufacturers' directions for preparation.
	2. Beverages	1, 2 cups (250, 500 ml)	This feature allows you to reheat 1 cup (250 ml) or 2 cups (500 ml) of room temperature beverages without setting power and time. NOTE: 1. Use a microwave safe cup. 2. Heated liquids can erupt if not mixed with air. Do not heat liquids in your microwave oven without stirring before and halfway through heating. 3. Care must be exercised not to overheat liquids when using the Beverage feature. It is programmed to give proper result when heating 1 cup (250 ml) or 2 cups (500 ml) of liquid, starting from room temperature. Overheating will cause an increased risk of scalding, or water eruption. Refer to page 2, item 18.
	3. Bacon	4 slices (3.2-4 oz) (90-110 g) 6 slices (4.8-5.8 oz) (135-165 g) 10 slices (8.1-9.5 oz) (230-270 g) 14 slices (11.6-13 oz) (330-370 g)	Place slices of bacon on top of paper-towel-lined microwave safe dish. Cover with paper towel. Time may vary by brand and weight. If bacon is not cooked to your liking, continue to heat by manually adding more time.
Lunch	4. Soup	1, 2 cups (250, 500 ml)	Pour soup into a microwave safe serving bowl. Cover with lid or vented plastic wrap. Stir after cooking.
	5. Frozen Pizza (single)	8 oz. (225 g)	Follow manufacturers' directions for preparation.
	6. Frozen Entrées	8, 10, 20, 32 oz. (225, 300, 600, 900 g)	Follow manufacturers' directions for preparation. After 2 beeps, stir or rearrange. Be careful when removing the film cover after cooking. Remove facing away from you to avoid steam burns. If additional time is needed, continue to cook manually.
Snack	7. Hot Dog	1, 2, 3, 4 hot dogs	Make 3 slits on each Hot Dog. Place Hot Dog on paper plate or microwave safe dish leaving space between each. Times may vary by size and manufacturer.
Side Dish	8. Potatoes	1, 2, 3, 4 potatoes (6 - 8 oz. each) (170 - 225 g)	Pierce each potato with a fork 6 times spacing around surface. Place potato or potatoes around the edge of paper-towel-lined glass tray (Turntable), at least 1 inch (2.5 cm) apart. Do not cover. Let stand 5 minutes to complete cooking.
	9. Fresh Vegetables	4, 8, 12, 16 oz. (110, 225, 340, 450 g)	All pieces should be the same size. Wash thoroughly, add 1 tbsp. of water per 1/2 cup of vegetables, and cover with lid or vented plastic wrap. Do not salt/butter until after cooking.
	10. Frozen Vegetables	6, 10, 16 oz. (170, 300, 450 g)	Wash thoroughly, add 1 tbsp. of water per 1/2 cup of vegetables, and cover with lid or vented plastic wrap. Do not salt/butter until after cooking. (Not suitable for vegetables in butter or sauce.) After 2 beeps, stir or rearrange.
Dinner	11. Frozen Dinners	11, 16 oz. (300, 450 g)	Follow manufactures' directions for covering or removing covers. Do not use frozen foods packaged in foil trays.
	12. Fish Fillets	4, 8, 12, 16 oz. (110, 225, 340, 450 g)	Arrange in a single layer. Cover with lid or vented plastic wrap.





Timer Feature

This feature allows you to program the oven as a kitchen timer. It can also be used to program a standing time after cooking is completed and/or to program a delay start.



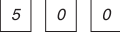

To Use as a Kitchen Timer:

Example: To count down 5 minutes.

1. 	• Press Timer .
2. 	• Set desired amount of time using number pads. (up to 99 minutes and 99 seconds).
3. 	• Press Start . ▶ Time will count down without oven operating.

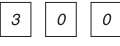
To Set Stand Time:





Example: To cook at P6 power for 3 minutes, with stand time of 5 minutes.

1.  Press 5 times	• Enter the desired Power Level (see page 11 for directions).
2. 	Set desired cooking time using number pads.
3. 	• Press Timer .
4. 	• Set desired amount of Stand Time using number pads. (up to 99 minutes and 99 seconds)
5. 	• Press Start . ▶ Cooking will start. After cooking, stand time will count down without oven operating.

CAUTION:
If oven lamp is lit while using the timer feature, the oven is incorrectly programmed. Stop oven immediately and re-read instructions.

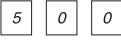
To Set Delay Start:

Example: To delay the start of cooking for 5 minutes, and cook at P6 power for 3 minutes.

1. 	• Press Timer .
2. 	• Enter desired amount of delay time using number pads. (up to 99 minutes and 99 seconds)
3.  Press 5 times	• Enter the desired Power Level (see page 11 for directions).
4. 	Set desired cooking time using number pads.
5. 	• Press Start . ▶ Delay time will count down. Then cooking will start.

NOTE:

1. When each stage finishes, a two-beep signal sounds. At the end of the program, the oven will beep five times.
2. If the oven door is opened during Stand Time, Kitchen Timer or Delay Time, the time on the display will continue to count down.
3. Stand time and Delay start cannot be programmed before any automatic Function. This is to prevent the starting temperature of food from rising before defrosting or cooking begins. A change in starting temperature could cause inaccurate results.



Microwave Shortcuts

FOOD	POWER	TIME (in mins.)	DIRECTIONS
To separate refrigerated Bacon , 1 pound (450 g)	P10 (High)	30 sec.	Remove wrapper and place in microwave safe dish. After heating, use a plastic spatula to separate slices.
To soften Brown Sugar 1 cup (250 ml)	P10 (High)	20 - 30 sec.	Place brown sugar in microwave safe dish with a slice of bread. Cover with lid or plastic wrap.
To soften refrigerated Butter , 1 stick, 1/4 pound (110 g)	P3 (MED-LOW)	1	Remove wrapper and place butter in a microwave safe dish.
To melt refrigerated Butter , 1 stick, 1/4 pound (110 g)	P6 (MEDIUM)	1 1/2 - 2	Remove wrapper and place butter in a microwave safe dish covered with lid or vented plastic wrap.
To melt Chocolate , 1 square, 1 oz. (28 g)	P6 (MEDIUM)	1 - 1 1/2	Remove wrapper and place chocolate in a microwave safe dish. After heating, stir until completely melted. Note: Chocolate holds its shape even when softened.
To melt Chocolate , 1/2 cup (125 ml) chips	P6 (MEDIUM)	1 - 1 1/2	
To toast Coconut , 1/2 cup (125 ml)	P10 (High)	1	Place in a microwave safe dish. Stir every 30 seconds.
To soften Cream Cheese , 8 oz. (225 g)	P3 (MED-LOW)	1 - 2	Remove wrapper and place in a microwave safe bowl.
To brown Ground Beef , 1 pound (450 g)	P10 (High)	4 - 5	Crumble into a microwave safe colander set into another dish. Cover with plastic wrap. Stir twice. Drain grease.
To cook Vegetables , Fresh (1/2 lb) (225 g)	P8	3 1/2 - 4	All pieces should be the same size. Wash thoroughly, add 1 tbsp of water per 1/2 cup of vegetables, and cover with lid or vented plastic wrap. Do not salt/butter until after cooking.
Frozen (10 oz) (285 g)	P8	3 1/2 - 4	
Canned (15 oz) (430 g)	P8	3 1/2 - 4	



Microwave Shortcuts (continued)

FOOD	POWER	TIME (in mins.)	DIRECTIONS
To cook baked Potato , (6 - 8 oz. each) (170 - 225 g) 1	P8	3½ - 4	Pierce each potato with a fork 6 times spacing around surface. Place potato or potatoes around the edge of paper-towel-lined glass tray (Turntable), at least 1 inch (2.5 cm) apart. Do not cover. Let stand 5 minutes to complete cooking.
2	P8	6 - 7	
To steam Hand Towels - 4	P10 (High)	20 - 30 sec.	Soak in water, then wring out excess. Place on a microwave safe dish. Heat. Present immediately.
To soften Ice Cream , ½ gallon (2 L)	P3 (MED-LOW)	1 - 1½	Check often to prevent melting.
Cup of liquid To boil water, broth , etc. 1 cup, 8 oz. (250 ml) 2 cups, 16 oz. (500 ml)	P10 (High)	1½ - 2 2½ - 3	Heated liquids can erupt if not stirred. Do not heat liquids in microwave oven without stirring before heating.
Cup of liquid To warm Beverage , 1 cup, 8 oz. (250 ml) 2 cups, 16 oz. (500 ml)	P7 (MED-HIGH)	1½ - 2 2½ - 3	
To roast Nuts , 1½ cups (375 ml)	P10 (High)	3 - 4	Spread nuts into a 9-inch (23 cm) microwave safe pie plate. Stir occasionally.
To toast Sesame Seeds , ¼ cup (60 ml)	P10 (High)	2 - 2½	Place in a small microwave safe bowl. Stir twice.
To skin Tomatoes , (one at a time)	P10 (High)	30 sec.	Place tomato into a microwave safe bowl containing boiling water. Rinse and peel. Repeat for each tomato.
To remove Cooking Odors ,	P10 (High)	5	Combine 1 to 1½ cups (250 - 375 ml) water with the juice and peel of one lemon in a 2 quart microwave safe bowl. After water finishes boiling, wipe interior of oven with a cloth.

Food Characteristics

Bone and Fat

Both bone and fat affect cooking. Bones may cause irregular cooking. Meat next to the tips of bones may overcook while meat positioned under a large bone, such as a ham bone, may be undercooked. Large amounts of fat absorb microwave energy and the meat next to these areas may overcook.



Density

Porous, airy foods such as breads, cakes or rolls take less time to cook than heavy, dense foods such as potatoes and roasts. When reheating donuts or other foods with different centers be very careful. Certain foods have centers made with sugar, water, or fat and these centers attract microwaves (For example, jelly donuts). When a jelly donut is heated, the jelly can become extremely hot while the exterior remains warm to the touch. This could result in a burn if the food is not allowed to cool properly in the center.



Quantity

Two potatoes take longer to cook than one potato. As the quantity of the food decreases so does the cooking time. Overcooking will cause the moisture content in the food to decrease and a fire could result. Never leave microwave unattended while in use.



Shape

Uniform sizes heat more evenly. The thin end of a drumstick will cook more quickly than the meaty end. To compensate for irregular shapes, place thin parts toward the center of the dish and thick pieces toward the edge.



Size

Thin pieces cook more quickly than thick pieces.



Starting Temperature

Foods that are at room temperature take less time to cook than if they are chilled, refrigerated, or frozen.



Cooking Techniques

Piercing

Foods with skins or membranes must be pierced, scored or have a strip of skin peeled before cooking to allow steam to escape. Pierce clams, oysters, chicken livers, whole potatoes and whole vegetables. Whole apples or new potatoes should have a 1-inch strip of skin peeled before cooking. Score sausages and frankfurters. Do not Cook/Reheat whole eggs with or without the shell. Steam build up in whole eggs may cause them to explode, and possibly damage the oven or cause injury. Reheating SLICED hard-boiled eggs and cooking SCRAMBLED eggs is safe.



Browning

Foods will not have the same brown appearance as conventionally cooked foods or those foods which are cooked utilizing a browning feature. Meats and poultry may be coated with browning sauce, Worcestershire sauce, barbecue sauce or shake-on browning sauce. To use, combine browning sauce with melted butter or margarine and brush on before cooking. For quick breads or muffins, brown sugar can be used in the recipe in place of granulated sugar, or the surface can be sprinkled with dark spices before baking.



Spacing

Individual foods, such as baked potatoes, cupcakes and appetizers, will cook more evenly if placed in the oven equal distances apart. When possible, arrange foods in a circular pattern.





Covering

As with conventional cooking, moisture evaporates during microwave cooking. Casserole lids or plastic wrap are used for a tighter seal. When using plastic wrap, vent the plastic wrap by folding back part of the plastic wrap from the edge of the dish to allow steam to escape. Loosen or remove plastic wrap as recipe directs for stand time. When removing plastic wrap covers, as well as any glass lids, be careful to remove them away from you to avoid steam burns. Various degrees of moisture retention are also obtained by using wax paper or paper towels.

Shielding

Thin areas of meat and poultry cook more quickly than meaty portions. To prevent overcooking, these thin areas can be shielded with strips of aluminum foil. Wooden toothpicks may be used to hold the foil in place.

▲ CAUTION is to be exercised when using foil. Arcing can occur if foil is too close to oven wall or door and damage to your oven will result.

Cooking time

A range of cooking time is given in each recipe. The time range compensates for the uncontrollable differences in food shapes, starting temperature, and regional preferences. Always cook food for the minimum cooking time given in a recipe and check for doneness. If the food is undercooked, continue cooking. It is easier to add time to an undercooked product. Once the food is overcooked, nothing can be done.

Stirring

Stirring is usually necessary during microwave cooking. Always bring the cooked outside edges toward the center and the less cooked center portions toward the outside of the dish.

Rearranging

Rearrange small items such as chicken pieces, shrimp, hamburger patties, or pork chops. Rearrange pieces from the edge to the center and pieces from the center to the edge of the dish.

Turning

It is not possible to stir some foods to distribute the heat evenly. At times, microwave energy will concentrate in one area of the food. To help insure even cooking, these food need to be turned. Turn over large foods, such as roasts or turkeys, halfway through cooking.

Stand Time

Most foods will continue to cook by conduction after the microwave oven is turned off. In meat cookery, the internal temperature will rise 5°F to 15°F (3°C to 8°C), if allowed to stand, tented with foil, for 10 to 15 minutes. Casseroles and vegetables need a shorter amount of standing time, but this standing time is necessary to allow foods to complete cooking to the center without overcooking on the edges.

Test for Doneness

The same tests for doneness used in conventional cooking may be used for microwave cooking. Meat is done when fork-tender or splits at fibers. Chicken is done when juices are clear yellow and drumstick moves freely. Fish is done when it flakes and is opaque. Cake is done when a toothpick or cake tester is inserted and comes out clean.

ABOUT FOOD SAFETY AND COOKING TEMPERATURE

• Check foods to see that they are cooked to the United States Department of Agriculture's recommended temperatures.

TEMP	FOOD
160°F	...for fresh pork, ground meat, boneless white poultry, fish, seafood, egg dishes and frozen prepared food.
165°F	...for leftover, ready-to-reheat refrigerated, and deli and carryout "fresh" food.
170°F	...white meat of poultry.
180°F	...dark meat of poultry.

To test for doneness, insert a meat thermometer in a thick or dense area away from fat or bone. NEVER leave the thermometer in the food during cooking, unless it is approved for microwave oven use.



Care and Cleaning of Your Microwave Oven

BEFORE CLEANING:

Unplug oven at wall outlet. If outlet is inaccessible, leave oven door open while cleaning.

AFTER CLEANING:

Be sure to place the Roller Ring and the Glass Tray in the proper position and press Stop/Reset Pad to clear the Display.

Menu Label:

Do not remove, wipe with a damp cloth.

Glass Tray:

Remove and wash in warm soapy water or in a dishwasher.

Outside oven surfaces:

Clean with a damp cloth. To prevent damage to the operating parts inside the oven, water should not be allowed to seep into ventilation openings.

Inside of the oven:

Wipe with a damp cloth after using. Mild detergent may be used if needed. Do not use harsh detergents or abrasives.

Oven Door:

Wipe with a soft dry cloth when steam accumulates inside or around the outside of the oven door. During cooking, especially under high humidity conditions, steam is given off from the food. (Some steam will condense on cooler surfaces, such as the oven door. This is normal.)

Inside surface is covered with a heat and vapor barrier film. **Do not remove.**

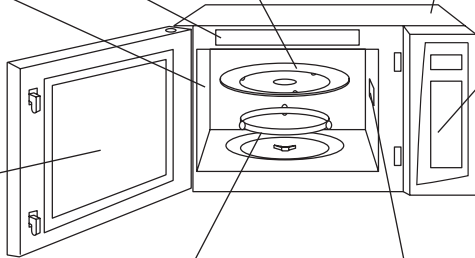

Roller Ring and oven cavity floor:

Clean the bottom surface of the oven with mild detergent water or window cleaner, and dry. Roller Ring may be washed in mild soapy water or dishwasher. These areas should be kept clean to avoid excessive noise.

Control Panel:

* Covered with a removable protective film to prevent scratches during shipping. Small bubbles may appear under this film. (Hint - To remove film, apply masking or clear tape to an exposed corner and pull gently.)

* If the Control Panel becomes wet, clean it with a soft dry cloth. Do not use harsh detergents or abrasives.

Do not remove wave guide cover: It is important to keep cover clean in the same manner as the inside of the oven.

IT IS IMPORTANT TO KEEP THE OVEN CLEAN AND DRY. FOOD RESIDUE AND CONDENSATION MAY CAUSE RUSTING OR ARCING AND DAMAGE TO THE OVEN. AFTER USE, WIPE DRY ALL SURFACES-INCLUDING VENT OPENINGS, OVEN SEAMS, AND UNDER GLASS TRAY.

PARTS DESCRIPTION	PART NUMBER
Instructions / Operating Manual (this book)	F00036K82AP
Glass Tray	F06014T01AP
Roller Ring Assembly	F290D9330AP

Accessory Purchases

Purchase Parts, Accessories and Instruction Books online for all Panasonic Products by visiting our Web Site at: <http://www.pasc.panasonic.com> or, send your request by E-mail to: nppcparts@us.panasonic.com

You may also contact us directly at:
1-800-332-5368 (Phone) 1-800-237-9080 (Fax Only) (Monday-Friday 9 am to 8 pm, EST.)
Panasonic Services Company
20421 84th Avenue South,
Kent, WA 98032
(We Accept Visa, MasterCard, Discover Card, American Express, and Personal Checks)

For hearing or speech impaired TTY users, TTY: 1-866-605-1277



Before Requesting Service

These things are normal:

The oven causes interference with my TV.

Some radio and TV interference might occur when you cook with the microwave oven. This interference is similar to the interference caused by small appliances such as mixers, vacuums, blow dryers, etc. It does not indicate a problem with your oven.

Steam accumulates on the oven door and warm air comes from the oven vents.

During cooking, steam and warm air are given off from the food. Most of the steam and warm air are removed from the oven by the air which circulates in the oven cavity. However, some steam will condense on cooler surfaces such as the oven door. This is normal. After use, the oven should be wiped dry (see page 22).

PROBLEM	POSSIBLE CAUSE	REMEDY
Oven will not turn on.	The oven is not plugged in securely.	Remove plug from outlet, wait 10 seconds and re-insert.
	Circuit breaker or fuse is tripped or blown.	Reset circuit breaker or replace fuse.
	There is a problem with the outlet.	Plug another appliance into the outlet to check if it is working.
Oven will not start cooking.	The door is not closed completely.	Close the oven door securely.
	Start Pad was not pressed after programming.	Press Start Pad.
	Another program is already entered into the oven.	Press Stop/Reset Pad to cancel the previous program and enter new program.
	The program is not correct.	Program again according to the Operating Instructions.
The Glass Tray wobbles.	Stop/Reset Pad has been pressed accidentally.	Program oven again.
	The Glass Tray is not positioned properly on the Roller Ring or there is food under the Roller Ring.	Take out Glass Tray and Roller Ring. Wipe with a damp cloth and reset Roller Ring and Glass Tray properly.
When the oven is operating, there is noise coming from the glass tray.	The Roller Ring and oven bottom are dirty.	Clean these parts according to Care and Cleaning of your Microwave Oven (see page 22).
The word "Child" appears in the Display Window.	The CHILD LOCK was activated by pressing Start pad 3 times.	Deactivate LOCK by pressing Stop/Reset pad 3 times.

Limited Warranty & Customer Services Directory

PANASONIC CONSUMER ELECTRONICS COMPANY,
DIVISION OF PANASONIC CORPORATION OF
NORTH AMERICA
One Panasonic Way
Secaucus, New Jersey 07094

PANASONIC SALES COMPANY,
DIVISION OF PANASONIC PUERTO
RICO, INC.
Ave. 65 de Infanteria, Km. 9.5
San Gabriel Industrial Park
Carolina, Puerto Rico 00985

Panasonic Microwave Oven Product Limited Warranty

Limited Warranty Coverage

If your product does not work properly because of a defect in materials or workmanship, Panasonic Consumer Electronics Company or Panasonic Sales Company (collectively referred to as "the warrantor") will, for the length of the period indicated on the chart below, which starts with the date of original purchase ("warranty period"), at its option either (a) repair your product with new or refurbished parts, or (b) replace it with a new or a refurbished product. The decision to repair or replace will be made by the warrantor.

	PARTS	LABOR
ALL PARTS (EXCEPT MAGNETRON TUBE)	1 (ONE) YEAR	1 (ONE) YEAR
MAGNETRON TUBE	5 (FIVE) YEAR	1 (ONE) YEAR

During the "Labor" warranty period there will be no charge for labor. During the "Parts" warranty period, there will be no charge for parts. You must carry-in or mail-in your product during the warranty period. This warranty only applies to products purchased and serviced in the United States or Puerto Rico. This warranty is extended only to the original purchaser of a new product which was not sold "as is". A purchase receipt or other proof of the original purchase date is required for warranty service.

Carry-In or Mail-In Service

For Carry-In or Mail-In Service in the United States call 1-800-211-PANA(7262) or visit Panasonic Web Site: <http://www.panasonic.com>

For assistance in Puerto Rico call Panasonic Sales Company (787)-750-4300 or fax (787)-768-2910.

Limited Warranty Limits And Exclusions

This warranty ONLY COVERS failures due to defects in materials or workmanship, and DOES NOT COVER glass, plastic parts, temperature probes(if included) and normal wear and tear or cosmetic damage. The warranty ALSO DOES NOT COVER damages which occurred in shipment, or failures which are caused by products not supplied by the warrantor, or failures which result from accidents, misuse, abuse, neglect, bug infestation, mishandling, misapplication, alteration, faulty installation, set-up adjustments, misadjustment of consumer controls, improper maintenance, power line surge, lightning damage, modification, or commercial use (such as in a hotel, office, restaurant, or other business), rental use of the product, service by anyone other than a Factory Service center or other Authorized Servicer, or damage that is attributable to acts of God.

THERE ARE NO EXPRESS WARRANTIES EXCEPT AS LISTED UNDER "LIMITED WARRANTY COVERAGE". THE WARRANTOR IS NOT LIABLE FOR INCIDENTAL OR CONSEQUENTIAL DAMAGES RESULTING FROM THE USE OF THIS PRODUCT, OR ARISING OUT OF ANY BREACH OF THIS WARRANTY. (As examples, this excludes damages for lost time, cost of having someone remove or re-install an installed unit if applicable, or travel to and from the servicer. The items listed are not exclusive, but are for illustration only.) **ALL EXPRESS AND IMPLIED WARRANTIES, INCLUDING THE WARRANTY OF MERCHANTABILITY, ARE LIMITED TO THE PERIOD OF THE LIMITED WARRANTY.**

Some states do not allow the exclusion or limitation of incidental or consequential damages, or limitations on how long an implied warranty lasts, so the exclusions may not apply to you.

This warranty gives you specific legal rights and you may also have others rights which vary from state to state. If a problem with this product develops during or after the warranty period, you may contact your dealer or Service center. If the problem is not handled to your satisfaction, then write to the warrantor's Consumer Affairs Department at the addresses listed for the warrantor.

PARTS AND SERVICE WHICH ARE NOT COVERED BY THIS LIMITED WARRANTY ARE YOUR RESPONSIBILITY.

Customer Services Directory

Obtain Product Information and Operating Assistance; locate your nearest Dealer or servicer; purchase Parts and Accessories; or make Customer Service and Literature requests by visiting our Web Site at: <http://www.panasonic.com/consumersupport>

or, contact us via the web at: <http://www.panasonic.com/contactinfo>































You may also contact us directly at: **1-800-211-PANA(7262)**,
Monday-Friday 9 am-9 pm; Saturday-Sunday 10 am-7 pm, EST.

For hearing or speech impaired TTY users, TTY: 1-877-833-8855

Service in Puerto Rico

Panasonic Puerto Rico, Inc.
Ave. 65 de Infantería, Km. 9.5, San Gabriel Industrial Park, Carolina, Puerto Rico 00985
Phone (787)750-4300, Fax (787)768-2910

QUICK GUIDE TO OPERATION

Feature	How to Operate
To set Clock (☛page 10)	 → <input type="text" value="0"/> Thru <input type="text" value="9"/> →  Press once. Enter time of day. Press once.
To set Power and Time (☛page 11)	 → <input type="text" value="0"/> Thru <input type="text" value="9"/> →  Press to select Power Level. Set cooking time. Press.
To Use Child Safety Lock (☛page 10)	To Set:  Press 3 times. To Cancel:  Press 3 times.
To cook using Popcorn (☛page 12)	 →   →  Select weight. Optional. Press.
To cook using Quick Min (☛page 11)	 (up to 10 min.) →  Press.
To reheat using Auto Reheat (☛page 15)	 →   →  Press to select serving. Optional. Press.
To cook using Auto Cook (☛page 15)	e.g.  →  →   →  Select food number. Select Serving/Weight. Optional. Press.
To defrost using Inverter Turbo Defrost (☛page 13)	 → <input type="text" value="0"/> Thru <input type="text" value="9"/> →  Press once. Set weight. Press.
To use Keep Warm (☛page 11)	 → <input type="text" value="0"/> Thru <input type="text" value="9"/> →  Press once. Set keep warm time. (up to 30 min.) Press.
To use as a Kitchen Timer (☛page 17)	 → <input type="text" value="0"/> Thru <input type="text" value="9"/> →  Press once. Set time. Press.
To Set Stand Time (☛page 17)	(Input up to 4-stage cooking programs.) →  → <input type="text" value="0"/> Thru <input type="text" value="9"/> →  Press once. Set time. Press.
To Set Delay Start (☛page 17)	 → <input type="text" value="0"/> Thru <input type="text" value="9"/> → (Input up to 4-stage cooking programs.) →  Press once. Set time. Press.



Specifications

	NN-S654	NN-S635/SA646
Power Source:	120 V, 60 Hz	
Power Consumption:	12.7 Amps, 1,460 W	12.7 Amps, 1,480 W
Cooking Power:*	1,300 W	
Outside Dimensions (H x W x D):	11 ⁷ / ₈ " x 20 ³ / ₈ " x 15 ⁷ / ₈ " (301 mm x 518 mm x 402 mm)	
Oven Cavity Dimensions (H x W x D):	8 ⁷ / ₈ " x 14 ³ / ₄ " x 15 ³ / ₁₆ " (225 mm x 375 mm x 386 mm)	
Operating Frequency:	2,450 MHz	
Net Weight:	Approx. 23 lbs. (10.7 kg)	

*IEC Test procedure

Specifications subject to change without notice.

User's Record

The serial number of this product may be found on the back side of the oven. You should note the model number and the serial number of this oven in the space provided and retain this book as a permanent record of your purchase for future reference.

Model No. _____

Serial No. _____

Date of Purchase _____

Panasonic Consumer Electronics Company, Division of Panasonic Corporation of North America
One Panasonic Way
Secaucus, New Jersey 07094

Panasonic Sales Company, Division of Panasonic Puerto Rico, Inc. ("PSC")
Ave. 65 de Infanteria, Km. 9.5
San Gabriel Industrial Park,
Carolina, Puerto Rico 00985

Matsushita Electric Industrial Co., Ltd.
Panasonic Home Appliances Microwave Oven (Shanghai) Co., Ltd.
898 Long Dong Road, Pu Dong, Shanghai, China 201203
Web Site: <http://www.panasonic.co.jp/global>