

This Owner's Manual is provided and hosted by [Appliance Factory Parts](#).



LG LCG3091ST Owner's Manual

[Shop genuine replacement parts for LG LCG3091ST](#)



[Find Your LG Gas Range Parts - Select From 55 Models](#)

----- Manual continues below -----



Internal Use Only

Website: <http://biz.lgservice.com>



Gas Cooktop

SERVICE MANUAL

MODEL: LCG3091ST
LCG3691ST

CAUTION

BEFORE SERVICING THE UNIT, READ THE SAFETY PRECAUTIONS IN THIS MANUAL.

P/NO : MFL62725601

July, 2009
Printed in Korea

CONTENTS

CONTENTS	2-3
SAFETY PRECAUTIONS	4-9
SPECIFICATIONS	10
INSTALLATION INSTRUCTIONS	11-17
• BEFORE YOU BEGIN	11
• UNPACKING THE COOKTOP	11
• DIMENSIONS AND CLEARANCES	12
• INSTALLING THE COOKTOP UNIT	13
• PROVIDE ADEQUATE GAS SUPPLY	14
• CONNECT THE COOKTOP TO GAS	14
• ELECTRICAL CONNECTIONS	15
• SEAL THE OPENINGS	15
• ASSEMBLE THE SURFACE BURNERS	16
• CHECK IGNITION OF SURFACE BURNERS	16
• ADJUST THE SURFACE BURNER LOW FLAME (SIMMER) SETTING	17
OPERATING INSTRUCTIONS	18-20
• USING THE GAS SURFACE BURNERS	18-19
• USING THE GRIDDLE	20
CARE AND CLEANING OF THE COOKTOP	21-24
• CARE AND CLEANING	21
• BURNER CAPS AND HEADS	22
• BURNER GRATES	23
• COOKTOP SURFACE	23
• STAINLESS STEEL SURFACES	24
• CONTROL KNOBS	24
WIRING DIAGRAM	25
COMPONENT LOCATIONS	26-27

COMPONENT REPLACEMENT	28-42
• Cooktop Plate	28
• Single Burner Body.....	29
• Double Burner Body	30
• Electrode Assembly(Spark Plug)	31
• Spark Module(I.G. Trans)	32
• LED Lamp Module	33
• Ignition Switch Assembly	34
• Single Burner Valve	35
• Double Burner Valve Assembly.....	36
• Burner Pipe Assembly.....	37
• Manifold Pipe Assembly.....	38
• Manifold Assembly.....	39
• Inlet Pipe Assembly	40
• Center Burner Bracket.....	41
• Side Burner Bracket(Left and Right)	42
CONVERSION TO LP GAS	43-46
FAILURE MODE FLOW CHART	47-50
TROUBLE SHOOTING	51
EXPLODED VIEW	52
REPLACEMENT PARTS LIST	53-56

SAFETY PRECAUTIONS

FORWARD

This LG Service Manual, "30 inch & 36 inch Gas Cooktop," provides the technician with information on the operation and service of the Gas Cooktop. It is to be used as a training Service Manual. For specific information on the model being serviced, refer to the "Owner's Manual" or "Tech Sheet" provided with the Gas Cooktop.

SAFETY PRECAUTIONS

- Repairs of the appliance should be carried out by a authorized service technician only. Incorrect repairs may result in dangerous situations. If you need repairs, contact an LG Service Center or your dealer.
- Electrical leads and cables should not be allowed to touch the cooktop.
- Rating plate is located on the bottom side of cooktop.
- The power supply of the appliance should be turned off when it is being repaired.

 **WARNING:** If the information in this manual is not followed exactly, a fire or explosion may result causing property damage, personal injury or death.

- DO NOT store or use gasoline or other flammable vapors and liquids in the vicinity of this or any other appliance.

- WHAT TO DO IF YOU SMELL GAS

- Do not try to light any appliance.
- Do not touch any electrical switch.
- Do not use any phone in the building.
- Immediately call the gas supplier from a neighbor's phone. Follow the gas supplier's instructions.
- If you cannot reach the gas supplier, call the fire department.

- Installation and service must be performed by a qualified installer, service agency or the gas supplier.

 **WARNING:** To avoid risk of severe personal injury or death, disconnect power before working/servicing on the appliance to avoid electrical shock.

 **WARNING:** For your safety, the information in this manual must be followed to minimize the risk of fire, electric shock, or to prevent property damage, personal injury, or death.

 **WARNING:**

- Replace all parts before operating.
- RECONNECT all grounding devices.
 - Failure to do so can result in severe personal injury death or electrical shock.

LG Electronics assumes no responsibility for any repairs made on our products by anyone other than Authorized Service Technicians.

SAFETY PRECAUTIONS

IMPORTANT SAFETY NOTICE

The California Safe Drinking Water and Toxic Enforcement Act requires the Governor of California to publish a list of substances known to the state to cause birth defects or other reproductive harm and requires businesses to warn customers of potential exposure to such substances.

SAFETY PRECAUTIONS

- **Proper Installation:** Be sure your appliance is properly installed and grounded by a qualified technician in accordance with the National Electrical Code ANSI/NFPA No. 70, latest edition in the United States, and all local code requirements. Install only per installation instructions.
- Do not attempt to repair or replace any part of your cooktop unless it is specifically recommended in this manual. All other service should be referred to a qualified technician.
- Remove all tape and packaging wrap before using the appliance. Destroy the carton and plastic bags after unpacking the appliance. Never allow children to play with packaging material.
- The safety aspects of this appliance comply with accepted technical standards.
- **Know how to disconnect the electrical power to the appliance at the circuit breaker or fuse box in case of an emergency.** Mark the breaker or fuse for ease of identification and swift action if necessary.
- **Do not repair or replace any part of the appliance.** All servicing should be done only by a qualified technician to avoid the risk of personal injury and damage to the appliance.
- **Never modify or alter the construction of an appliance such as removal of panels, wire covers or any other permanent part of the product.**
- **Storage on appliance: Flammable materials should not be stored near or on the cooking surface.** This includes paper, plastic and cloth items, such as cookbooks, plasticware and towels, as well as flammable liquids. Do not store explosives, such as aerosol cans, on or near the appliance. Flammable materials may explode and result in fire or property damage.
- **Do not leave children alone. Children should not be left alone or unattended in the area where an appliance is in use.** They should never be allowed to sit or stand on any part of the appliance.
- Do not store or use gasoline or other flammable vapors and liquids in the vicinity of this or any other appliance.

 **CAUTION:** Items of interest to children should not be stored in cabinets above a cooktop or on the backsplash of a cooktop—children climbing on the cooktop to reach items could be seriously injured.

 **WARNING:** Never use your appliance for warming or heating a room.

SAFETY PRECAUTIONS

SAFETY PRECAUTIONS (cont.)

- **Wear proper apparel. Loose-fitting or hanging garments should never be worn while using the appliance.** Do not let clothing or other flammable materials contact hot surfaces.
- **Do not use water or flour on grease fires.** Smother the fire with a pan lid, or use baking soda, a dry chemical or foam-type extinguisher.
- **When heating fat or grease, watch it closely.** Fat or grease may catch fire if allowed to become too hot.
- **Use only dry pot holders.** Moist or damp pot holders on hot surfaces may result in burns from steam. Do not let the pot holders touch hot surface units. Do not use a towel or other bulky cloth instead of a pot holder.
- **Do not heat unopened food containers.** Buildup of pressure may cause the container to burst and result in injury.



CAUTION: DO NOT touch burners or grates after use.

DO NOT allow clothing or other flammable materials to touch burner areas until they have had sufficient time to cool.

ELECTRICAL SAFETY



WARNING: If the supply cord is damaged, it must be replaced by the manufacturer, its service agent or similarly qualified persons in order to avoid a hazard.

- The installation and connection of the new appliance must only be carried out by qualified personnel.

CHILD SAFETY



WARNING: • This appliance is not intended for use by young children or infirm persons unless they have been adequately supervised by a responsible person to ensure that they can use the appliance safely.

- Young children should be supervised to ensure that they do not play with the appliance.
- Accessible parts may become hot during use. Young children should be kept away.

SAFETY DURING USE

- **This appliance may only be used for normal cooking and frying in the home.** It is not designed for commercial or industrial purposes.
- **Do not use the cooktop to heat the room.**
- **Take care when plugging in electric appliances near the cooktop.** Cords must not come into contact with the hot surface. This could cause damage to the cooktop and cable insulation.

SAFETY PRECAUTIONS

SAFETY DURING USE (cont.)

- **Overheated fats and oils catch fire quickly.** You should supervise cooking when preparing foods in fat or oil.
- **Turn off all burners after use.**
- **Never place combustible items on the cooktop.**
- **Never keep any combustible items or aerosol cans in a drawer located under the cooktop.**
- **Do not use a wok on the surface burners if the wok has a round metal ring that is placed over the burner grate to support the wok.** This ring acts as a heat trap, which may damage the burner grate and burner head. Also, it may cause the burner to work improperly. This may cause a carbon monoxide level above that allowed by current standards, resulting in a health hazard.
- **Clean the appliance regularly to keep all parts free of grease that could catch fire.** Exhaust fan ventilation hoods and grease filters should be kept clean. Do not allow grease to accumulate on hood or filter. Greasy deposits in the fan could catch fire. Refer to hood manufacturer's instructions for cleaning.
- **Use Proper Pan Sizes.** Do not use pans that are unstable or easily tipped. Select cookware having flat bottoms large enough to cover burner grates. To avoid spillovers, make sure cookware is large enough to contain the food properly. This will both save cleaning time and prevent hazardous accumulations of food, since heavy spattering or spillovers left on range can ignite. Use pans with handles that can be easily grasped and remain cool.
- **NEVER let the flames extend up the sides of the cookware for safe handling of cookware.** Flames larger than the bottom of the cookware will not result in faster heating of the cookware and could be hazardous.
- **Do not place any object on or near the gas knob control area.**
- **Do not let pot holders come in contact with open flame when lifting cookware off burners.**
- **Do not use a towel or other bulky cloth in place of a pot holder.**
- **Always the turn knob to the "LITE" the position when igniting the top burners and make sure the burners have ignited.**
- **Glazed cooking utensils: Only certain types of glass, glass/ceramic, ceramic, earthenware, or other glazed utensils are suitable for cooktop service without breaking due to the sudden change in temperature.** Check the manufacturer's recommendations for cooktop use.
- **Ventilating hood: The ventilating hood above your cooking surface should be cleaned frequently, so the grease from cooking vapors does not accumulate on the hood or filter.**

SAFETY PRECAUTIONS

SAFETY DURING USE (cont.)

- **Do not flame foods on the cooktop.** If you do flame foods under the hood, turn the fan on.
- **Do not lift the cooktop. Lifting the cooktop can cause damage and improper operation of the cooktop.**
- **If the cooktop is located near a window, do not hang long curtains that could blow over the surface burners and catch on fire.**
- **If you smell gas, turn off the gas to the cooktop and call a qualified service technician. Never use an open flame to locate a leak.**
- **Never leave surface units unattended at high flame settings.** Boilover causes smoking and greasy spillovers that may ignite.
- **Smother fire or flame in a pan with a lid or cookie sheet. NEVER pick up or move a flaming pan.**
- **Do not use water on grease fires. Use baking soda a dry chemical or foam-type extinguisher to smother fire or flame.**
- **To prevent burns, always be sure that the controls for all burners are at the “OFF” position and all grates are cool before attempting to remove them.**
- **Always the turn knob to the “OFF” position before removing cookware.**

SAFETY WHEN CLEANING

- **Always switch off the appliance before cleaning.**
- **For safety reasons, do not clean the appliance with a steam jet or high-pressure washer.**
- **Clean the cooktop in accordance with the maintenance and cleaning instructions in owners manual.**
- **Do not use a steel wool pad; it will scratch the surface.**
- **To clean the stainless steel surface, use warm soapy water or a stainless steel cleaner or polish.** Always wipe the surface in the direction of the grain. Follow the cleaner instructions for cleaning the stainless steel surface.

HOW TO AVOID DAMAGE TO THE APPLIANCE

- **Do not operate the burners with empty pots or pans.**
- **Do not turn on the burners with no pots or pans on the grates.**
- **Be very cautious if removing or replacing the grates or burner parts. Moving these can cause scratches on the cooktop.**
- **Do not use cookware with any dirt build up on the bottom.**

 **CAUTION: Burn Hazard:** The burners can remain hot after use. Allow time for the burners to cool before handling them.

SAFETY PRECAUTIONS

DISPOSAL OF OLD APPLIANCES

To protect the environment, it is important that worn-out appliances are disposed of in the correct manner.

- The appliance must not be disposed of with household rubbish.
- You can obtain information about collection dates or public refuse disposal sites from your local health council or environmental health office.

 **CAUTION:** Before disposing of old appliances please make them inoperable so they cannot be a source of danger.

**READ AND FOLLOW THIS SAFETY INFORMATION CAREFULLY.
SAVE THESE INSTRUCTIONS**

SPECIFICATIONS

ITEM	DESCRIPTION	
MODEL	LCG3091ST	LCG3691ST
Power Requirement	120 Vac, 60Hz.	120 Vac, 60Hz.
The Number of Grates	3 pcs	3 pcs
Knob type	Blue Back Light	Blue Back Light
Heating Element	Gas(Natural / LP)	Gas(Natural / LP)
Design	Stainless Steel Cooktop	Stainless Steel Cooktop
Burners	Natural / LP [BTU/HR]	Natural / LP [BTU/HR]
Left Front	9100 / 9100	9100 / 9100
Left Rear	9100 / 9100	9100 / 9100
Right Front	12000 / 9500	12000 / 9500
Right Rear	5000 / 5000	5000 / 5000
Center	19000 / 15000	19000 / 15000
Cook top Dimensions (without Grates)	30"(762mm) x 21 ¹¹ / ₁₆ "(550mm) x 4 ¹ / ₈ "(104mm)	36"(914.4mm) x 21 ¹¹ / ₁₆ "(550mm) x 4 ¹ / ₈ "(104mm)
Countertop Cutout Dimensions	28 ¹ / ₂ "(724mm) x 19 ¹¹ / ₁₆ "(500mm)	33 ¹⁵ / ₁₆ "(862mm) x 19 ¹¹ / ₁₆ "(500mm)
Shipping Weight	57.54lb(26.1kg)	61.29lb(27.8kg)

INSTALLATION INSTRUCTIONS

**INSTALLATION AND SERVICE MUST BE PERFORMED BY A QUALIFIED INSTALLER.
IMPORTANT: SAVE THESE INSTRUCTIONS FOR LOCAL ELECTRICAL
INSPECTOR'S USE.
READ AND SAVE THESE INSTRUCTIONS FOR FUTURE REFERENCE.**

BEFORE YOU BEGIN

Read these instructions completely and carefully.

NOTES TO INSTALLER:

- Read all instructions contained in these installation instructions before installing the cooktop.
- Remove all packing material before connecting the electrical supply to the cooktop.
- Observe all governing codes and ordinances.
- Only certain cooktop models may be installed over certain built-in electric oven models.
- Be sure to leave these instructions with the consumer.

NOTE TO CONSUMER:

Keep this User's Guide and Installation Instructions for future reference.

NOTE: This appliance must be properly grounded.

Damage caused by failure to follow these instructions is not covered by the cooktop warranty.

UNPACKING THE COOKTOP

- Unpack and visually inspect the cooktop for any damage or missing components.

INSTALLATION INSTRUCTIONS

DIMENSIONS AND CLEARANCES

- Provide enough clearances between the cooktop and adjacent combustible surfaces. These dimensions must be met for safe use of your cooktop. The location of the electrical outlet and pipe opening may be adjusted to meet specific requirements. The cooktop may be placed with 2 3/4" clearance to the back wall.

1. MAINTAIN THE FOLLOWING MINIMUM CLEARANCE DIMENSIONS

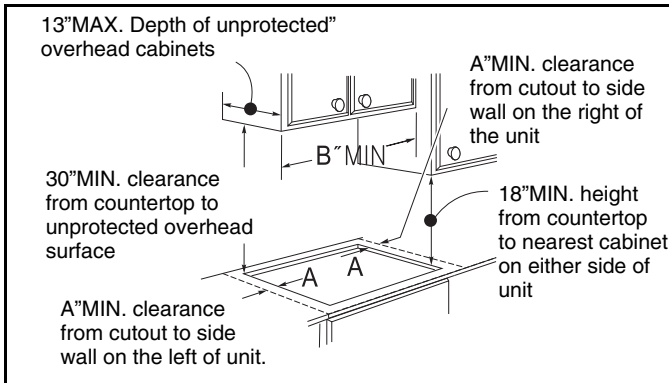

3. RECOMMENDED GAS SUPPLY LOCATION FROM BACKWALL

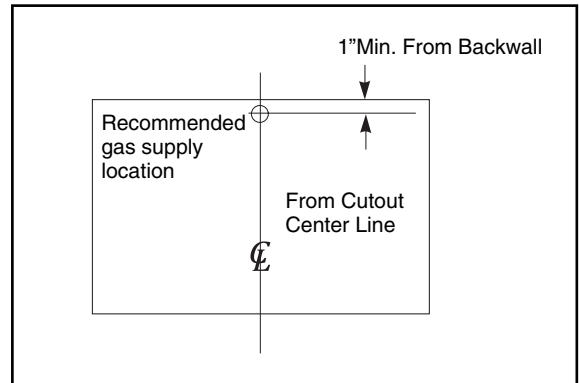

2. COOKTOP AND CUTOUT DIMENSIONS

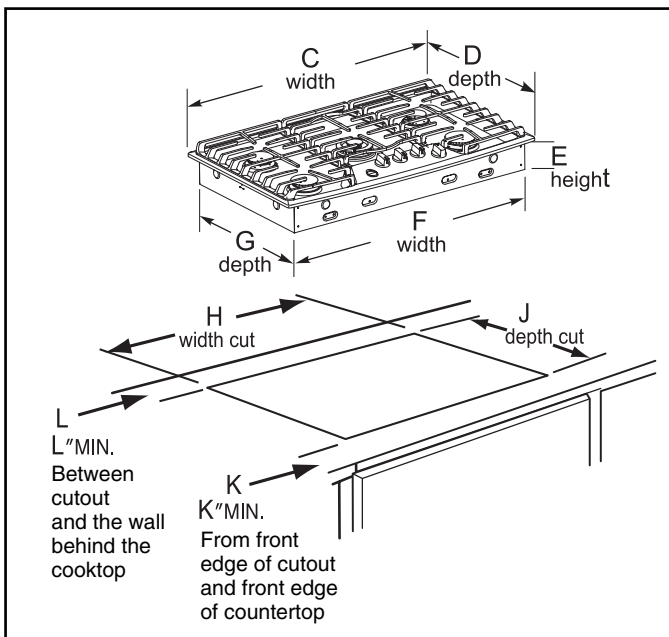

4. MAKE SURE WALL COVERINGS, COUNTERTOP AND CABINETS AROUND COOKTOP CAN WITHSTAND HEAT (UP TO 200°F) GENERATED BY COOKTOP

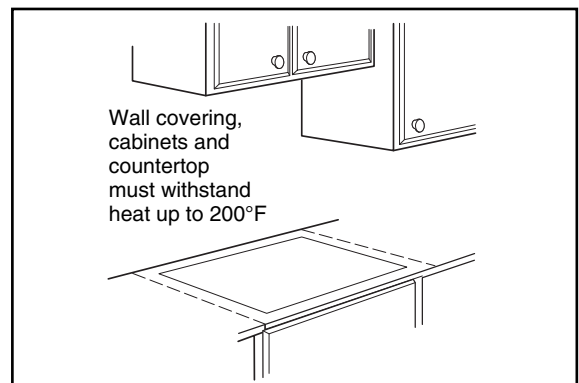

To ensure accuracy, it is best to make a template when cutting the opening in the counter

MODEL	A	B	C	D	E	F	G	H	J	K	L
30" Cooktop	11 ¹³ / ₁₆ "	30"	30"	21 ¹¹ / ₁₆ "	3 ³ / ₄ "	28 ¹ / ₄ "	19 ³ / ₈ "	28 ¹ / ₂ "	19 ¹¹ / ₁₆ "	1 ⁵ / ₈ "	2 ³ / ₄ "
36" Cooktop	11 ¹³ / ₁₆ "	36"	36"	21 ¹¹ / ₁₆ "	3 ³ / ₄ "	33 ⁵ / ₈ "	19 ³ / ₈ "	33 ¹⁵ / ₁₆ "	19 ¹¹ / ₁₆ "	1 ⁵ / ₈ "	2 ³ / ₄ "

INSTALLATION INSTRUCTIONS

PROVIDE ADEQUATE GAS SUPPLY

- This cooktop is designed to operate at a pressure of 5" of water column on natural gas or 10" of water column on LP, propane or butane gas.
- Make sure you are supplying your cooktop with the type of gas for which it is designed.
- This cooktop is convertible for use on natural or propane gas. When using this cooktop on LP gas, conversion must be made by a qualified LP installer before attempting to operate the cooktop on that gas.
- For correct operation, the pressure of natural gas supplied to the regulator should be between 5" and 13" of water column.
- For LP gas, the pressure supplied must be between 10" and 13" of water column.
- When checking for correct operation of the regulator, the inlet pressure must be at least 1" more than the operating -manifold- pressure as given above.
- The pressure regulator located at the inlet of the cooktop manifold must remain in the supply line regardless of whether natural or LP gas is being used.
- A flexible metal appliance connector used to connect the cooktop to the gas supply line must have an I.D. of $\frac{5}{8}$ " and can be 3 feet in length easily for installation. In Canada, flexible connectors should be single wall metal connectors less than 6 feet in length.

CONNECT THE COOKTOP TO GAS

- Shut off the main gas supply valve before removing the old cooktop and leave it off until the new hook-up has been completed. Don't forget to relight the pilot on other gas appliances when you turn the gas back on.
 - Because hard piping restricts movement of the cooktop, the use of a CSA International-certified flexible metal appliance connector is recommended unless local codes require a hard-piped connection.
 - Never reuse an old connector when installing a new cooktop. If the hard piping method is used, you must carefully align the pipe; the cooktop cannot be moved after the connection is made.
 - To protect gas leaks, put pipe joint compound on, all male -external- pipe threads.
- ① Install a manual gas line shut-off valve in the gas line in an easily accessed location outside of the cooktop. Be sure everyone operating the cooktop knows where and how to shut off the gas supply to the cooktop.
 - ② Install male $\frac{1}{2}$ " flare union adapter to the $\frac{1}{2}$ " NPT internal thread at inlet of pressure regulator. Use a backup wrench on the pressure regulator fitting to prevent damage.
 - ③ Install male $\frac{1}{2}$ " or $\frac{3}{4}$ " flare union adapter to the NPT internal thread of the manual shut-off valve, taking care to back-up the shut-off valve to keep it from turning.
 - ④ Connect flexible metal connector to the adapter on the cooktop. Position cooktop to permit connection at the shut-off valve.



WARNING: DO NOT USE A FLAME TO CHECK FOR GAS LEAKS.

Disconnect the cooktop and its individual shut-off valve from the gas supply piping system during any pressure testing of that system at test pressures more than $\frac{1}{2}$ psig(3.5kPa). Isolate the cooktop from the gas supply piping system by closing its individual shut-off valve during any pressure testing of the gas supply system at test pressures equal to or less than $\frac{1}{2}$ psig(3.5kPa)

INSTALLATION INSTRUCTIONS

ELECTRICAL CONNECTIONS

ELECTRICAL REQUIREMENTS

120 Volt, 60 Hertz, properly grounded dedicated circuit protected by a 15 A or 20 A circuit breaker or time delay fuse.

GROUNDING

IMPORTANT: FOR PERSONAL SAFETY, THIS APPLIANCE MUST BE PROPERLY GROUNDED.

- The power cord of this appliance should be equipped with a three-prong (grounding) plug which mates with a standard three-prong grounding wall receptacle to reduce the possibility of electric shock hazard from this appliance.
- The customer should have the wall receptacle and circuit checked by a qualified technician to be sure the receptacle is properly grounded.
- When connecting the cord of this cooktop to a standard two-prong wall receptacle, it is the personal responsibility and obligation of the customer to have it replaced with a properly grounded three-prong wall receptacle.

DO NOT, UNDER ANY CIRCUMSTANCES, CUT OR REMOVE THE THIRD (GROUND) PRONG FROM THE POWER CORD.

- A word about Ground Fault Circuit Interrupters-Ground Fault Circuit Interrupters are not required or recommended for gas range receptacles. Ground Fault Circuit Interrupters are devices that sense leakage of current in a circuit and automatically switch off power when a threshold leakage level is detected. These devices must be manually reset by the customer. The National Electrical Code requires the use of Ground Fault Circuit Interrupters in kitchen receptacles installed to serve countertop surfaces. Performance of the cooktop will not be affected if it is operated from a Ground Fault Circuit Interrupters protected circuit but occasional nuisance can occur.

⚠ CAUTION: The customer should have the circuit checked by a qualified technician to make sure the receptacle is correctly grounded.

- DO NOT use an adapter plug because disconnecting of the power cord places undue strain on the adapter and causes eventual failure of the adapter ground terminal.
- The customer must have the two-prong wall receptacle replaced with a three-prong (grounding) receptacle by a qualified technician before using this cooktop.
- The installation of appliances designed for mobile home installation should conform with the Manufactured Home Construction and Safety Standard, Title 24 CFR, Part 3280 (formerly the Federal Standard for Mobile Home Construction and Safety, Title 24, HUD, Part 280) or, when such standard is not applicable, the Standard for Manufactured Home Installations, latest edition (Manufactured Home Sites, Communities and Set-Ups), ANSI A225.1, latest edition, or with local codes. In Canada, mobile home installation must comply with the current CAN/CSA Z240/MH Mobile Home Installation Code.

SEAL THE OPENINGS

- Seal any openings in the wall behind the cooktop and in the floor of the cabinet when hookups are completed.

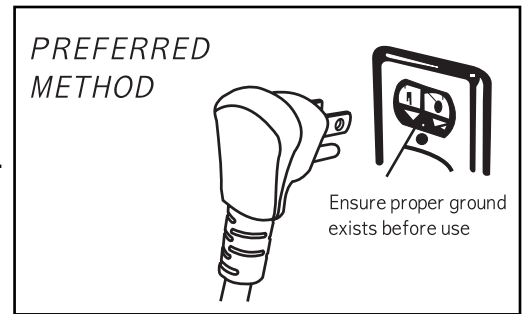

INSTALLATION INSTRUCTIONS

ASSEMBLE THE SURFACE BURNERS

 **CAUTION:** DO NOT operate the burners without all parts in place.

- Place the burner caps and heads on the cooktop.
- Make sure that the caps and heads are placed in the correct locations.

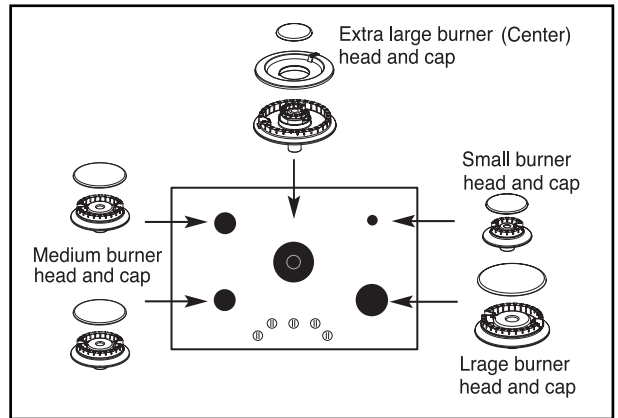

- Make sure the hole in the burner head is positioned over the electrode.

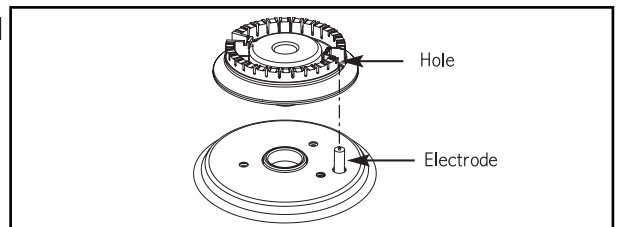

CHECK IGNITION OF SURFACE BURNERS

Operation of all cooktop burners should be checked after the COOKTOP and gas supply lines have been carefully checked for leaks.

ELECTRIC IGNITION

- Select a top burner knob, push down and then turn counterclockwise to the "LITE" position.
- You can hear a clicking sound indicating proper operation of the spark module.
- Once the air has been purged from the supply lines, burner should ignite within 4 seconds.
- After burner ignites, rotate knob out of the "LITE" position. Try each burner in succession until all burners have been checked.

QUALITY OF FLAMES

- The combustion quality of burner flames needs to be confirmed visually.

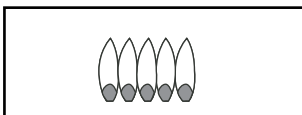

A Yellow flames
Call for service

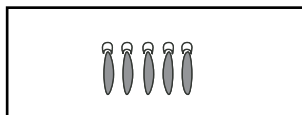

B Yellow tips on outer cones
It is normal for LP gas

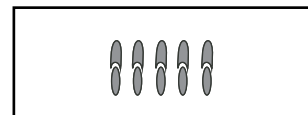

C Soft blue flames
It is normal for natural gas

- If burner flames look like A, call for service. B or C is normal burner flames, depending on the type of gas you use.
- With LP gas, some yellow tipping on outer cones is normal.

INSTALLATION INSTRUCTIONS

ADJUST THE SURFACE BURNER LOW FLAME (SIMMER) SETTING

For all surface burners except for the center burner

- ❶ Light all surface burners except for the center burner.
- ❷ Turn the knob on the burner being adjusted to "LO"(LOW).
- ❸ Remove knob.
- ❹ Insert a small, flat bladed screwdriver into the valve stem as shown in Fig.1.
- ❺ Turn the adjustment screw until the flame reaches the desired size.
- ❻ Replace the knob.
- ❼ Test The Flame Stability.

Test 1: • Turn the knob from "HI" to "LOW" quickly.

- If the flame goes out, increase the flame size and test again.

Test 2: • With the burner on a "LOW" setting, open and close the oven or cabinet door quickly.

- If the flame is extinguished by the air currents created by the door movement, increase the flame height and test again.

- ❽ Repeat steps 1 - 6 for each surface burner except for center burner.

Only For the center burner

- ❶ Disconnect power to appliance.
- ❷ Remove grates, burners caps, burner heads and knobs.
- ❸ Remove the all the screws on the cooktop by philips screwdriver.
- ❹ Remove cooktop by lifting up.
- ❺ Remove LED lamp module of the center valve by unclipping. In this case, the ignition switch should be positioned properly.
- ❻ Replace the cooktop back and secure the screws of the cooktop.
- ❼ Position center burner head, center burner cap, center grate, center knob.
- ❽ Connect power to appliance.
- ❾ Light center burner.
- ❿ Turn the knob on the burner being adjusted to "LO"(LOW).
- ⓫ Remove knob.

⓬ Using a small, flat bladed screwdriver insert into the hole next to the valve stem to adjust outer flame as shown in Fig.2.

⓭ Turn the adjustment screw until the flame reaches the desired size.

⓮ Replace the knob.

⓯ Test The Flame Stability.

Test 1: • Turn the knob from "HI" to "LOW" quickly.

- If the flame goes out, increase the flame size and test again.

Test 2: • With the burner on a "LOW" setting, open and close the oven or cabinet door quickly.

- If the flame is extinguished by the air currents created by the door movement, increase the flame height and test again.

⓰ After low flame setting, turn off the burner.

⓱ Remove knob, grate, burner cap, burner head.

⓲ Remove all screw of the cook top.

⓳ Reposition center LED lamp module by hooking.

⓴ Reposition cook top and secure all screws of cook top.

⓵ Reposition burner heads, burner caps, grates and knobs.

⓶ Connect power to appliance.

⓷ Disconnected power to appliance.

⓸ Remove cook top by lifting up.

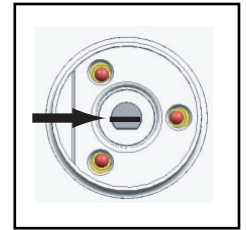

Center adjustment screw
Fig. 1

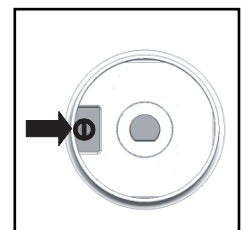

Adjustment screw next to
the valve shaft
Fig. 2

OPERATING INSTRUCTIONS

USING THE GAS SURFACE BURNERS

Throughout this manual, features and appearance may vary from your model.

- Make sure all grates on the cooktop are properly placed before using any burner.
- Be sure the burners and grates are cool before you place your hand, a pot holder, cleaning cloths or other materials on them.
- Make sure all burners are in place.
- Do not operate the burner for an extended period of time without cookware on the grate. The finish on the grate may chip without cookware to absorb the heat.

HOW TO LIGHT A GAS SURFACE BURNER

- Be sure all the surface burners are placed in their respective positions.
- Push the control knob in and turn it to the “LITE” positions.
- You can hear a little CLICKING noise - the sound of the electric spark igniting the burners.
- To control the flame size, turn the knob. If the knob stays at “LITE”, it will continue to click.
- When turning a burner to LITE, all the burners spark. Do not attempt to disassemble or clean around any burner while another burner is on. An electric shock may result, which could cause you to knock over hot cookware.
- The medium (left front & rear) and the large (right front) burners are the primary burners for most cooking. These general-purpose burners can be turned down from “HI” to “LO” suit a wide range of cooking needs.
- The extra large burner (center) is the maximum output burner. Like the other four burners, it can be turned down from “HI” to “LO” for a wide range of cooking applications.
- This burner is also designed to quickly bring large amounts of liquid to a boil. It has a special “SUPER BOIL” setting designed to be used with cookware 10 inches or larger in diameter.
- The middle burners are for large pots/pans or for use with the griddle. (LCG3691ST Only)
- The extra large burner(dual) can be also turned down to “LO” for a low simmer setting almost like the small burner.

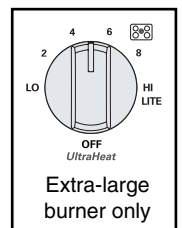
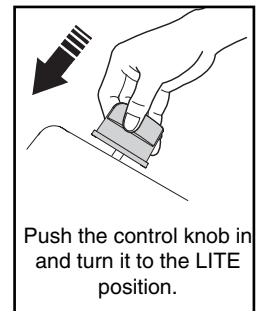

SEALED GAS BURNERS

Your cooktop has five sealed gas burners. They offer convenience, cleanability and flexibility to be used in a wide range of cooking applications. The smallest burners are in the right rear this burner can be turned. These burners can be turned down to “LO” for a very low simmer setting. They provide precise cooking performance for delicate foods such as sauces or food that require low heat for a long cooking time.

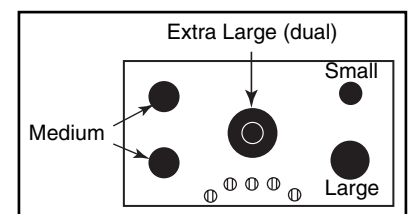

IN CASE OF POWER FAILURE

In case of a power failure, you can light the gas surface burners on your cooktop with a match. Hold a lit match to the burner, then push in and turn the control knob to the “LITE” position. Use extreme caution when lighting burners this way. Surface burners in use when an electrical power failure occurs will continue to operate normally.

OPERATING INSTRUCTIONS

USING THE GAS SURFACE BURNERS

HOW TO SELECT FLAME SIZE

- NEVER let the flames extend up the sides of the cookware for safe handling of cookware.
- Watch the flame, not the knob, as you reduce heat. When fast heating is desired, the flame size on a gas burner should match the cookware you are using.
- Flames larger than the bottom of the cookware will not result in faster heating of the cookware and could be hazardous.

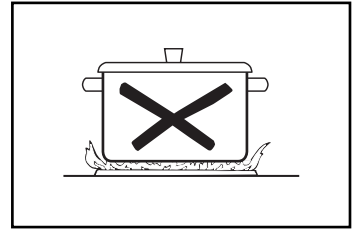

COOKWARE

- Aluminum: Medium-weight cookware is recommended because it heats quickly and evenly. Most of the foods brown evenly in an aluminum skillet. Use saucepans with tight fitting lids when cooking with minimum amounts of water.
- Cast-Iron: If heated slowly, most skillets will give satisfactory results.
- Stainless Steel: This metal alone has poor heating properties and is usually combined with copper, aluminum or other metals for improved heat distribution. Combination metal skillets usually work satisfactorily if they are used with medium heat as the manufacturer recommends.
- Enamelware: Under some conditions, the enamel of some cookware may melt. Follow cookware manufacturer's recommendations for cooking methods.
- Glass: There are two types of glass cookware-those for oven use only and those for top of the range cooking (saucepans, coffee and teapots). Glass conducts heat very slowly.
- Heatproof Glass Ceramic: Can be used for either surface or oven cooking. It conducts heat very slowly and cools very slowly. Check cookware manufacturer's directions to be sure it can be used on gas ranges.

USING A WOK

- Do not use a wok support ring. Placing the ring over the burner or grate may cause the burner to work improperly, resulting in carbon monoxide levels above allowable standards.
- This can be hazardous to your health.
- We recommend that you use a 14-inch or smaller flat-bottomed wok. Make sure the wok bottom sits flat on the grate. They are available at your local retail store.
- Only a flat-bottomed wok should be used.

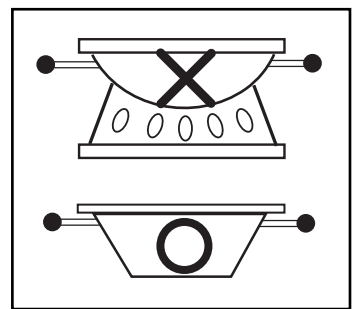

STOVE-TOP GRILLS

- Do not use stove top grills on your surface burners. If you use the stove top grill on the surface burner, it will cause incomplete combustion and can result in exposure to carbon monoxide levels above allowable current standards.
- This can be hazardous to your health.



OPERATING INSTRUCTIONS

USING THE GRIDDLE

- Your non-stick coated griddle provides an extra-large The griddle must only be used on the left side grate. cooking surface for meats, pancakes or other food usually prepared in a frying pan or skillet.

NOTE: Your griddle will discolor over time as it becomes seasoned with use.

- **How to Place the Griddle:** The griddle can only be used on the left side grate. The griddle must be properly placed on the center grate.

NOTE: Do not remove the left side grate when using the griddle.

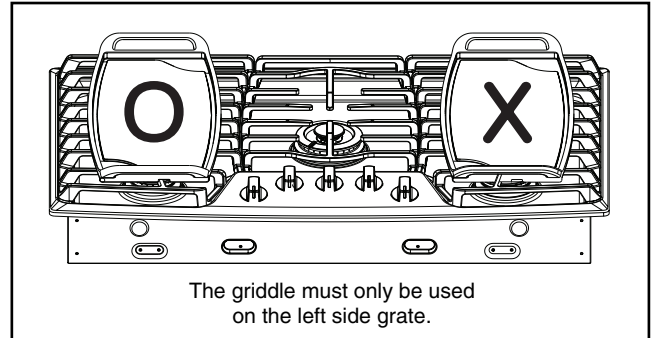

CAUTION

- Do not remove the griddle plate until the cooktop grates, surfaces and griddle plate are completely cooled.

CAUTION

- The griddle plate on the cooktop may become very hot when using the cooktop, oven or broiler systems. Always use oven mitts when placing or removing the griddle plate.

IMPORTANT NOTES:

- Avoid cooking extremely greasy foods, grease spill over can occur.
- The griddle can become hot when surrounding burners are in use.
- Do not overheat the griddle. This can damage to the non stick coating.
- Do not use metal utensils that can damage the griddle surface. Do not cut foods on the griddle.
- Do not place or store items on the griddle.

CARE AND CLEANING OF THE COOKTOP

CARE AND CLEANING

Make sure electrical power is off and all surfaces are cool before cleaning any part of the cooktop.

SEALED BURNER ASSEMBLIES

- Turn all controls OFF before removing the burner parts.
- The burner grates, caps, and burner heads can be lifted off, making them easy to clean.
- The electrodes are not removable.

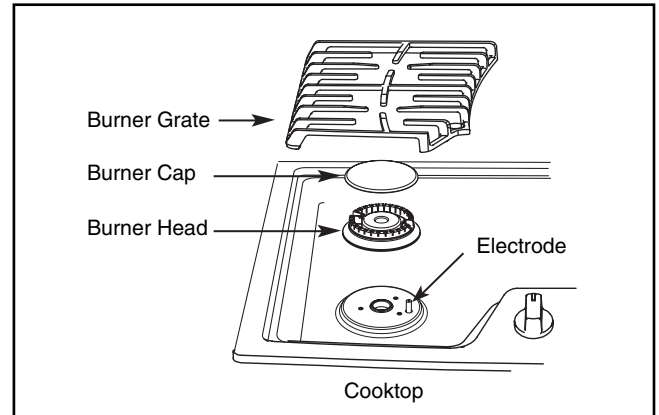

DUAL EXTRA BURNER ASSEMBLY

- The burner head, the outer cap and the inner cap can be lifted off, making it easy to clean.
- The burner electrode is not removable.

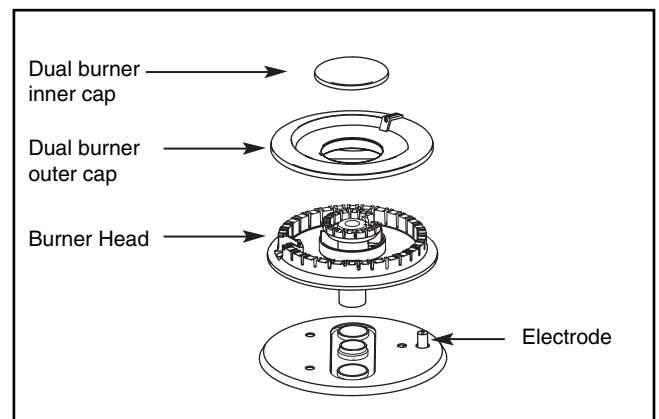

CAUTION

- **DO NOT** remove any parts from the cooktop until they have completely cooled and are safe to handle. Do not operate the surface burners unless all burner parts and grates are properly placed.

The electrode of the burner is exposed when the burner head and cap are removed. When one burner is turned to "LITE", all the burner spark.

Do not attempt to disassemble or clean around any burner while another burner is on.

An electric shock may result, which could cause you to knock over hot cookware.

CARE AND CLEANING OF THE COOKTOP

BURNER CAPS AND HEADS

BURNER CAPS

Lift burner caps off when they are cool.
Wash burner caps in hot, soapy water and rinse with clean water. You may scour with a plastic scouring pad to remove burned-on food particles.

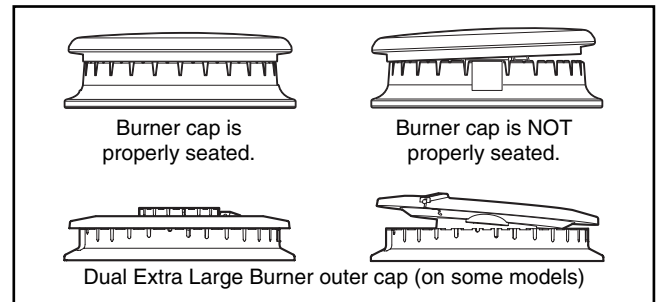

To place the dual extra large burner outer cap properly, make sure the slit in the burner cap is positioned over the assemble guide in the burner head.

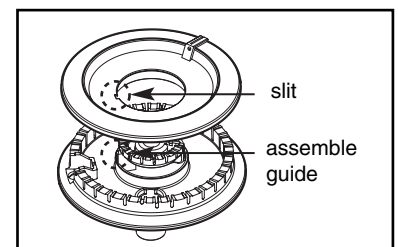

BURNER HEADS

The burner heads are removable. Simply lift them off the cooktop for cleaning.
The slits in the burner heads must be kept clean at all times for an even flame. Clogged or dirty burner ports or electrodes may cause improper operation of the cooktop. Any spill on or around an electrode must be carefully cleaned. Take care to not hit an electrode with anything hard or it could be damaged.

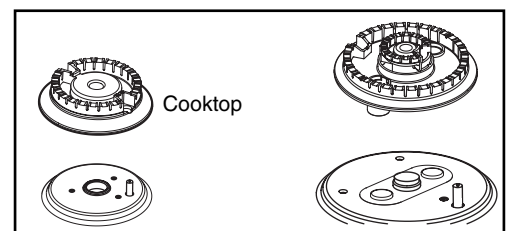

You should clean the burner caps and heads routinely, especially after bad spillovers which could clog the openings. Lift burner heads off when they are cool.
To get rid of burned-on food, soak the burner heads in a solution of mild liquid detergent and hot water for 20-30 minutes. For more stubborn stains, use a toothbrush.

NOTES:

- Do not use steel wool or scouring powders to clean the burners.
- Burners will not light if the cap is removed.

AFTER CLEANING

Before placing the burner caps and burner heads back, shake out excess water and then dry them thoroughly.

REPLACEMENT

Replace burner heads and caps over the electrodes on the cooktop, in the correct locations according to their size. There are one small, two medium, one large and one extra large burner head and cap.

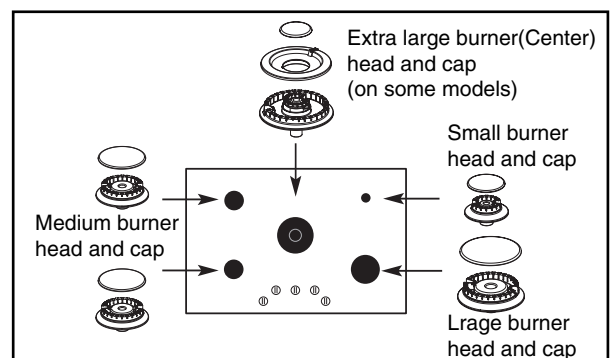

CARE AND CLEANING OF THE COOKTOP

BURNER GRATES

- Your cooktop has three professional-style grates. These grates are position-specific.
- For maximum stability, these grates should only be used in their proper position; The two side grates can not be interchanged left to right and front to back. The center grate can not be also interchanged front to back.

CLEANING

Lift grates off when they are cool. Grates should be cleaned regularly and, of course, after spillovers. Wash them in hot, soapy water and rinse with clean water. When replacing the grates, be sure they are positioned properly over the burners. Replace the grates so that continuous arcs are formed with the center ribs of all three grates.

The grates may be cleaned in a dishwasher. Do not operate a burner for a long time without cookware on the grate. The finish on the grate may chip without cookware to absorb the heat.

To remove burned-on food, place the grates in a covered container.

Soak them with $\frac{1}{4}$ cup ammonia for several hours. or overnight. Wash, rinse well and dry.

Although they are durable, the grates will gradually lose their shine, regardless of the best care you can give them. This is due to their continual exposure to high temperatures. You will notice this sooner with lighter color grates.

NOTE: Do not clean the grates in a self-cleaning oven.

COOKTOP SURFACE

To prevent damage to the stainless steel surface of the cooktop and to prevent it from becoming dull, clean up spills immediately. Foods with a lot of acid (such as tomatoes, sauerkraut, fruit juices, etc.) or foods with high sugar content could cause a dull spot if allowed to set. When the surface has cooled, wash and rinse.

For other spills such as fat splatterings, etc., wash with soap and water after the surface has cooled. Then rinse and polish by using a dry cloth.

NOTE: Do not place flammable materials on or near the cooktop.

Do not store or use combustible materials, gasoline or other flammable vapors and liquids in the vicinity of this or any other appliance.

NOTE: Do not try to lift the cooktop.

Lifting the cooktop can cause damage and improper operation of the cooktop.

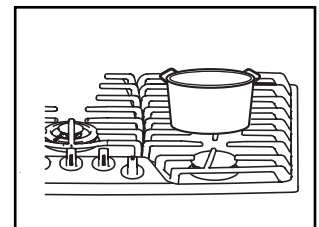
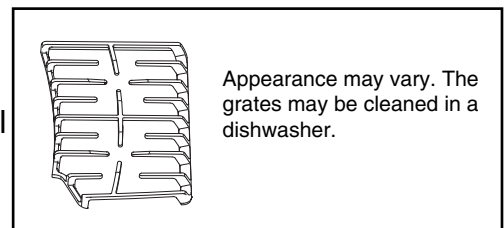
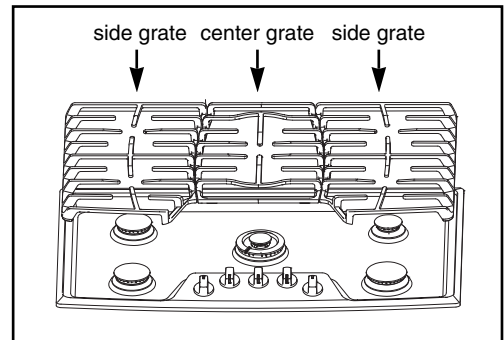

CARE AND CLEANING OF THE COOKTOP

STAINLESS STEEL SURFACES

Do not use a steel wool pad; it will scratch the surface.

To clean the stainless steel surface, use warm soapy water or a stainless steel cleaner or polish. Always wipe the surface in the direction of the grain. Follow the cleaner instructions for cleaning the stainless steel surface.

To inquire about purchasing stainless steel appliance cleaner or polish, or to find the location of a dealer nearest you, please call our toll-free customer service number:

1-800-243-0000

or visit our website at:

us.lgservice.com

CONTROL KNOBS

It's a good idea to wipe the control panel after each use of the cooktop.

Clean or rinse the control panel by using a damp cloth.

Use mild soap and water or a 50/50 solution of vinegar and water. Use clean water for rinsing.

Do not use abrasive cleansers, strong liquid cleaners, plastic scouring pads or oven cleaners on the control knobs - they can cause damage to the finish of the knobs.

Do not try to bend knobs by pulling them up or down or by hanging a towel or other such loads.

This can damage the gas valve shaft.

The control knobs may be removed for easier cleaning.

Make sure the knobs are in the "OFF" positions and pull them straight off the stems for cleaning.

To reinstall the knobs, make sure the knob has the "OFF" position centered at the top and slide the knob directly onto the stem.

NOTE: To prevent mis-operation during cleaning of the control knobs, Unplug your cooktop.

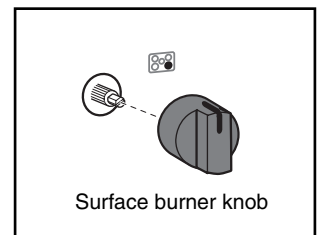

WIRING DIAGRAM

⚠ WARNING: • POWER MUST BE DISCONNECTED BEFORE SERVICING THIS APPLIANCE

COLOR	SYMBOL
RED	RD
WHITE	WH
ORANGE	OR
GREEN	G
YELLOW	YL
VIOLET	V
BLUE	BL
GRAY	GY
BROWN	BR
BLACK	BK

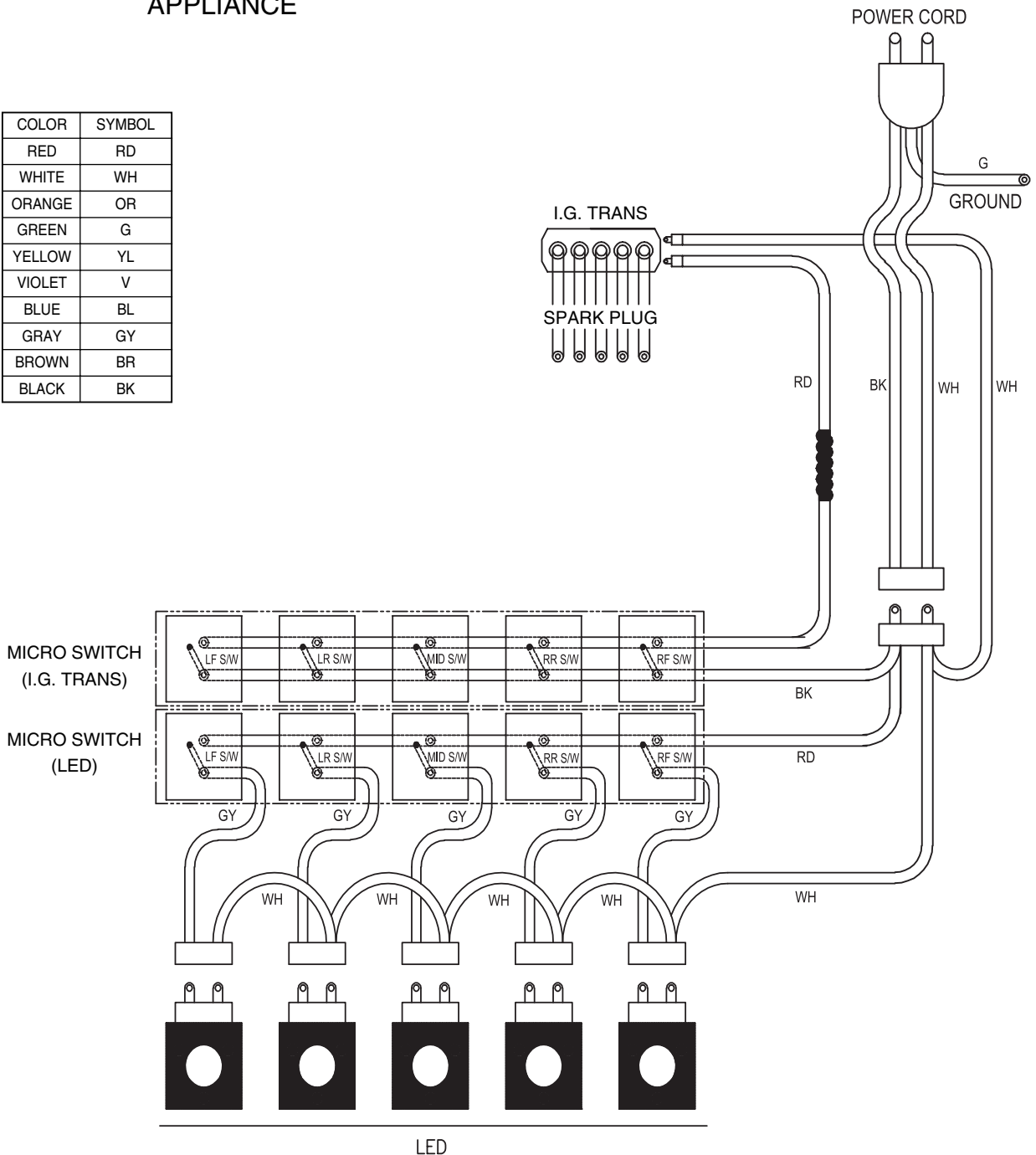

NOTE: 1. THIS CIRCUIT FOR LCG3691ST/LCG3091ST
2. **WARNING:** POWER MUST BE DISCONNECTED BEFORE SERVICING THE APPLIANCE .

⚠ WARNING: "LABEL ALL WIRES PRIOR TO DISCONNECTION WHEN SERVICING CONTROLS WIRING. ERRORS CAN CAUSE IMPROPER AND DANGEROUS OPERATION." VERIFY PROPER OPERATION AFTER SERVICING.

COMPONENT LOCATIONS

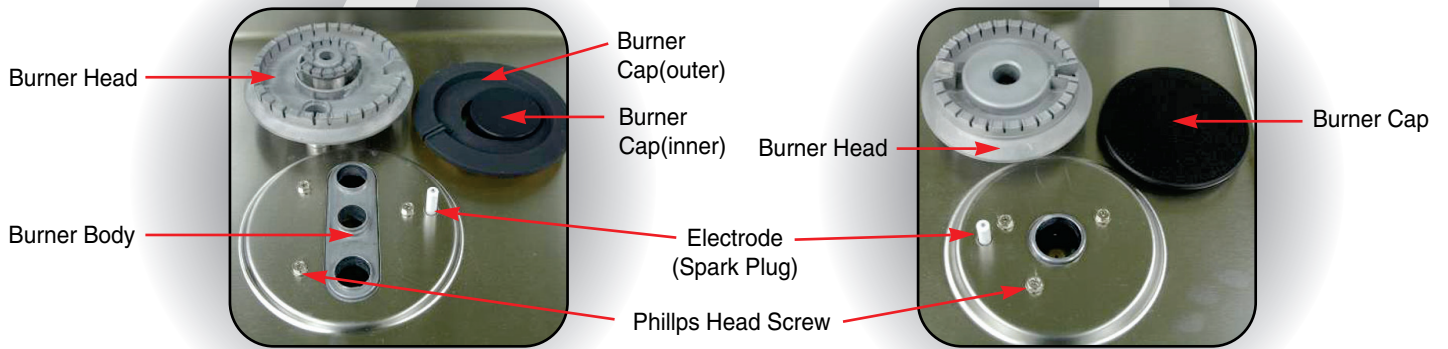
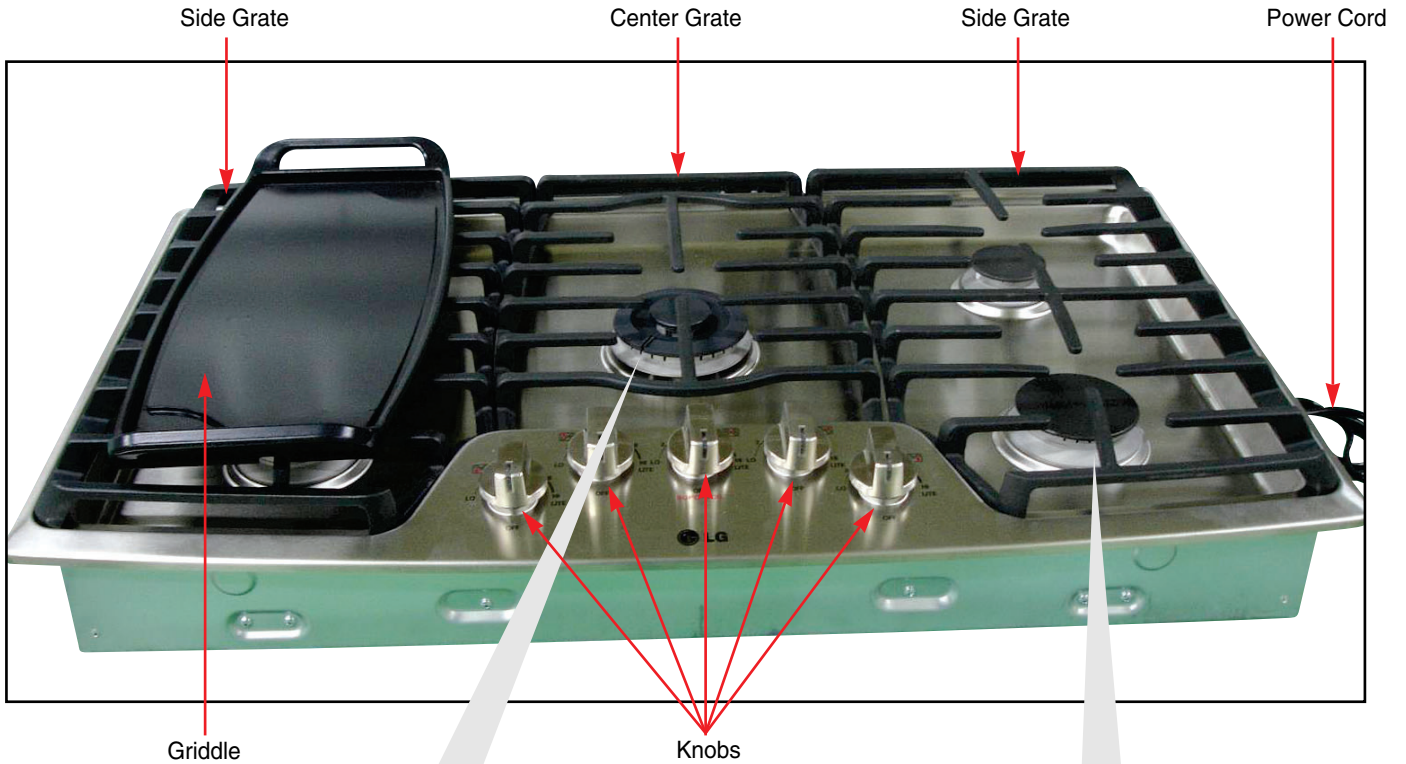

COMPONENT LOCATIONS

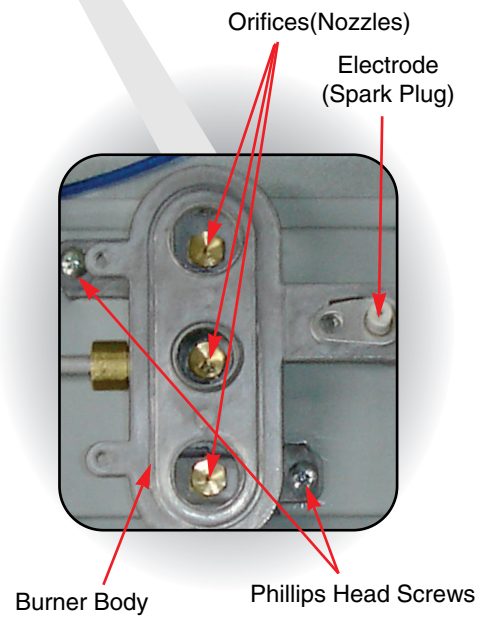
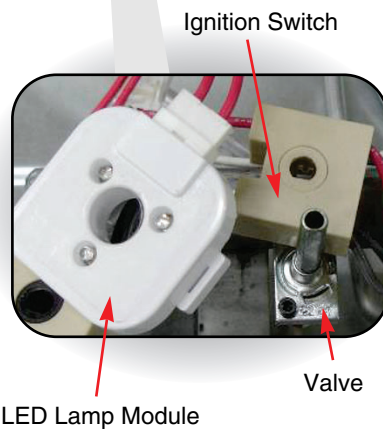
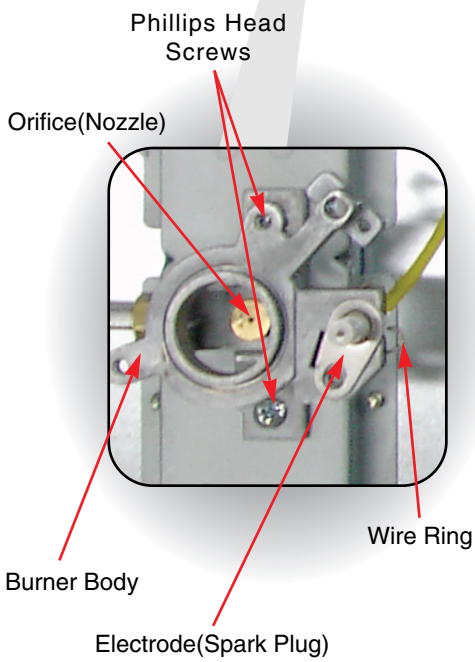
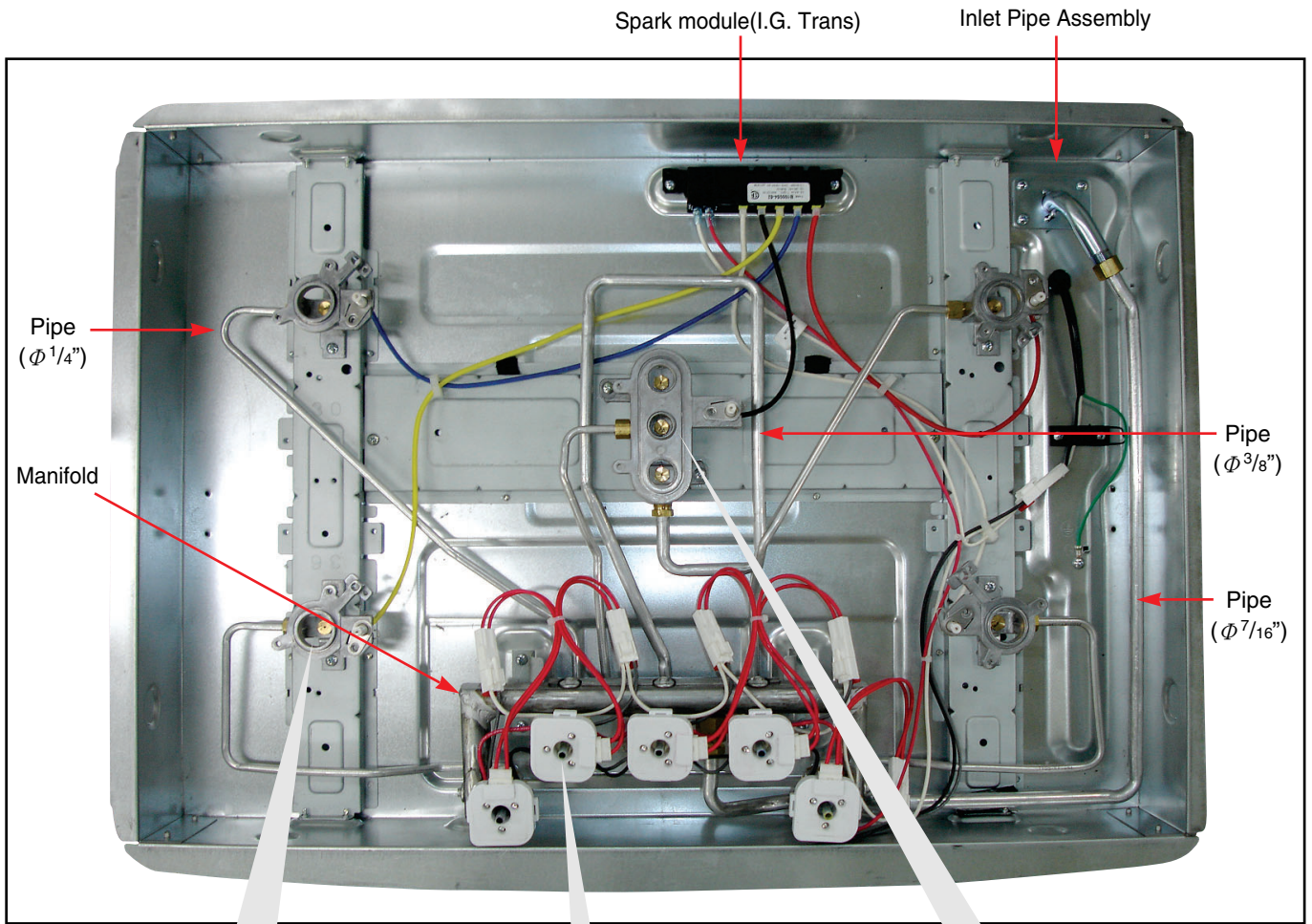

COMPONENT REPLACEMENT

Unit must be disconnected from electrical supply when making repairs, replacements, adjustments and continuity checks.

Cooktop Plate

WARNING

- **DISCONNECT** power supply before servicing.
 - **SHUT OFF** gas supply to the cooktop before servicing.
 - **Replace all panels and parts before operating.**
 - **RECONNECT** all grounding devices.
- Failure to do so can result in severe personal injury, death or electrical shock.

CAUTION

- **Be careful when you work on the Cooktop handling the sheet metal part.**

Disassembly

1. Disconnect the power from the main source and shut off gas to the cooktop.
2. Remove the griddle, 3 grates, the 6 burner caps and 5 burner heads.
3. Remove all gas control knobs.
4. Remove all 15 screws from cooktop burner housings.

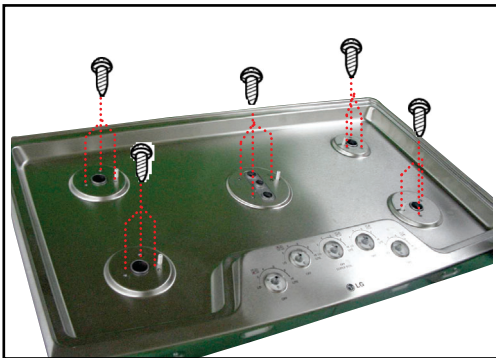

5. Remove the Stainless Steel cooktop.



When replacing this part with new one, progress reversely.

COMPONENT REPLACEMENT

Single Burner Body

WARNING

- **DISCONNECT** power supply before servicing.
- **SHUT OFF** gas supply to the cooktop before servicing.
- **Replace all panels and parts before operating.**
- **RECONNECT** all grounding devices.
- Failure to do so can result in severe personal injury, death or electrical shock.

CAUTION

- **Be careful when you work on the Cooktop handling the sheet metal part.**

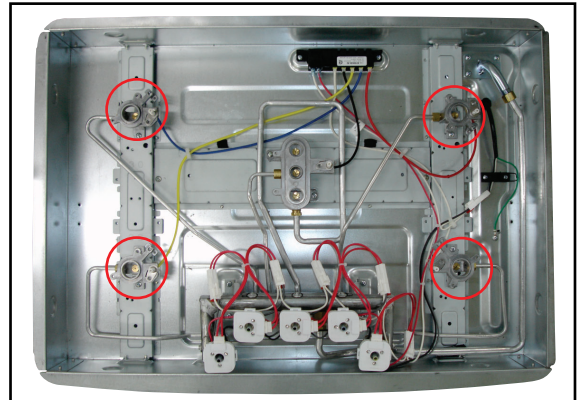

1. Remove the cooktop plate. (See “Cooktop Plate”.)
2. Remove the electrode. (See “Electrode Assembly”.)
3. Remove the 1/2 inch tubing fitting.
4. Unfasten the 2 phillips head screws.

① Left Front Burner

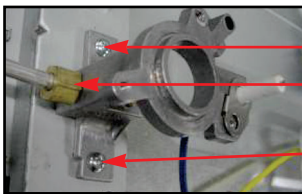

Phillips Head Screw

1/2in. Nut

Phillips Head Screw

② Left Rear Burner

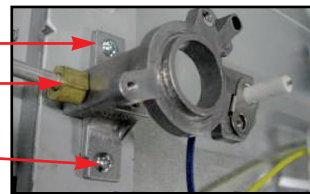

③ Right Front Burner

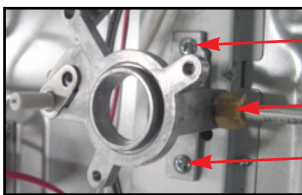

Phillips Head Screw

1/2in. Nut

Phillips Head Screw

④ Right Front Burner

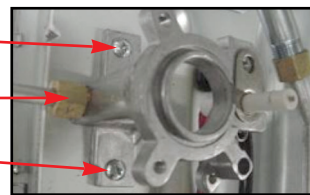

5. Lift the burner body which would be replaced.



When replacing this part with new one, progress reversely

COMPONENT REPLACEMENT

Double Burner Body

WARNING

- **DISCONNECT** power supply before servicing.
- **SHUT OFF** gas supply to the cooktop before servicing.
- **Replace all panels and parts before operating.**
- **RECONNECT** all grounding devices.
- Failure to do so can result in severe personal injury, death or electrical shock.

CAUTION

- **Be careful when you work on the Cooktop handling the sheet metal part.**

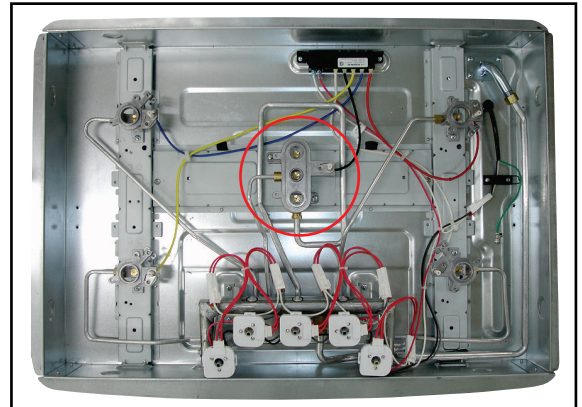

1. Remove the cooktop plate.(See “**Cooktop Plate**”.)
2. Remove the electrode.(See “**Electrode Assembly**”.)
3. Remove the 1/2 inch tubing fitting and the 11/16 inch tubing fitting from the burner gas housing.
4. Unfasten the 2 screws as shown below picture.

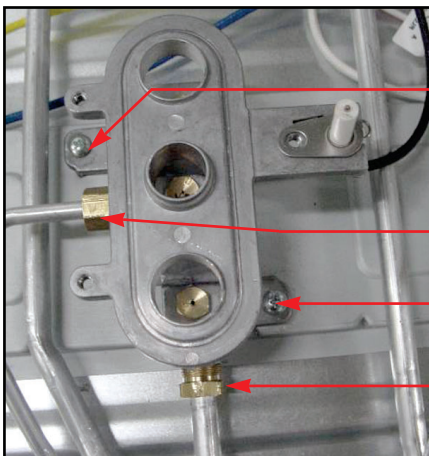

Phillips Head Screw

1/2-in. Nut

Phillips Head Screw

11/16-in. Nut

5. Lift the burner body.



When replacing this part with new one, progress reversely

COMPONENT REPLACEMENT

Electrode Assembly(Spark Plug)

WARNING

- **DISCONNECT** power supply before servicing.
- **SHUT OFF** gas supply to the cooktop before servicing.
- **Replace all panels and parts before operating.**
- **RECONNECT** all grounding devices.
- Failure to do so can result in severe personal injury, death or electrical shock.

CAUTION

- **Be careful when you work on the Cooktop handling the sheet metal part.**

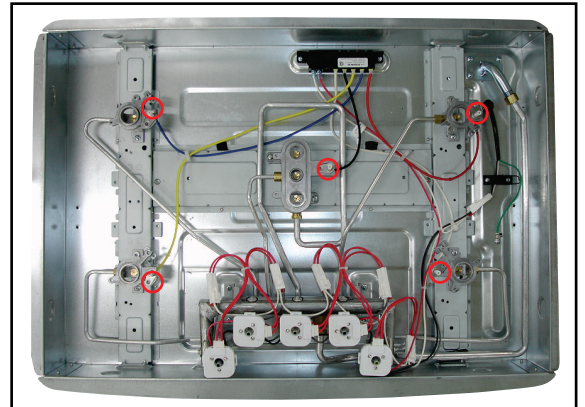

1. Remove the cooktop plate.(See “Cooktop Plate”.)
2. Remove the wire ring.

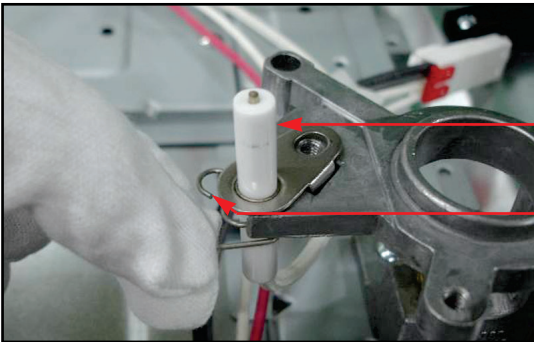

Electrode(Spark Plug)

Wire Ring

3. Unplug the connector by pulling it.



Connector

4. Lift the electrode assembly.

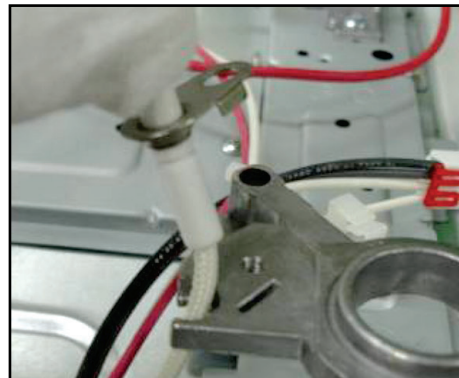

When replacing this part with new one, progress reversely

COMPONENT REPLACEMENT

Spark Module(I.G. Trans)

WARNING

- **DISCONNECT** power supply before servicing.
- **SHUT OFF** gas supply to the cooktop before servicing.
- **Replace all panels and parts before operating.**
- **RECONNECT** all grounding devices.
- Failure to do so can result in severe personal injury, death or electrical shock.

CAUTION

- **Be careful when you work on the Cooktop handling the sheet metal part.**

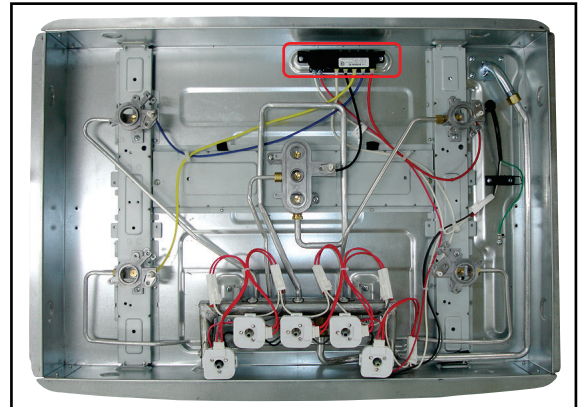

1. Remove the cooktop plate.(See “Cooktop Plate”.)
2. Disconnect the 7 connectors.

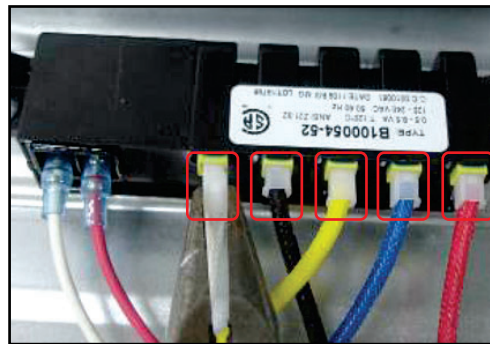
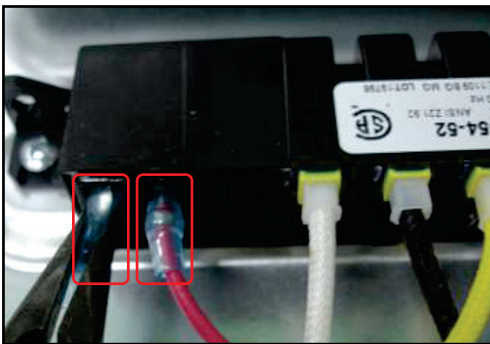

3. Unfasten the 2 screws.



When replacing this part with new one, progress reversely.

COMPONENT REPLACEMENT

LED Lamp Module

WARNING

- **DISCONNECT** power supply before servicing.
- **SHUT OFF** gas supply to the cooktop before servicing.
- **Replace all panels and parts before operating.**
- **RECONNECT** all grounding devices.
- Failure to do so can result in severe personal injury, death or electrical shock.

CAUTION

- **Be careful when you work on the Cooktop handling the sheet metal part.**

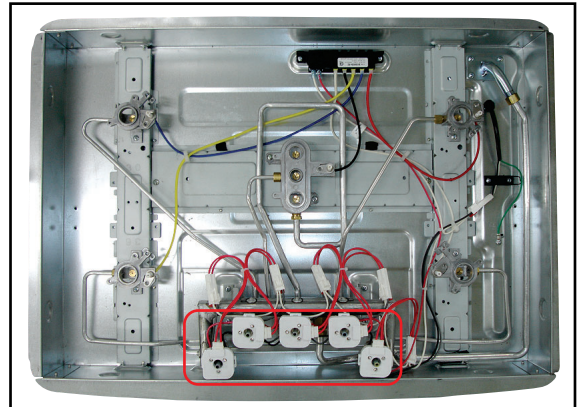

1. Remove the cooktop plate.(See “**Cooktop Plate**”.)
2. Remove the LED lamp module form the valve by unclipping.

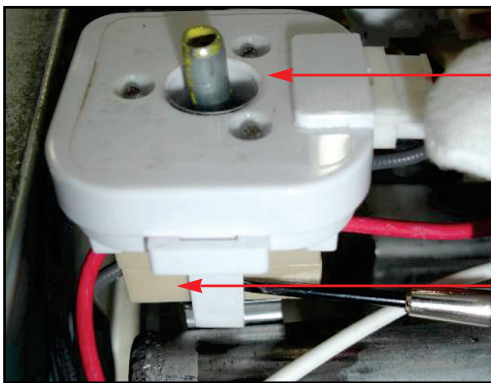

LED Lamp Module

Ignition Switch

3. Unplug the connector.

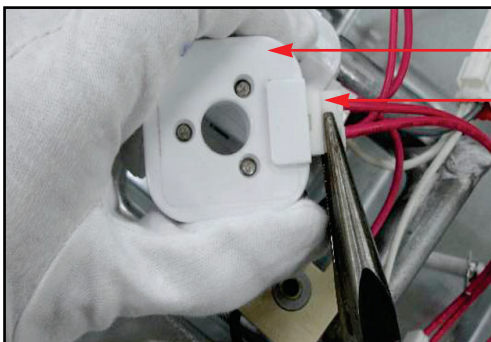

LED Lamp Module

Connector

4. Remove the LED lamp module.

When replacing this part with new one, progress reversely.

COMPONENT REPLACEMENT

Ignition Switch Assembly

WARNING

- **DISCONNECT** power supply before servicing.
 - **SHUT OFF** gas supply to the cooktop before servicing.
 - **Replace all panels and parts before operating.**
 - **RECONNECT** all grounding devices.
- Failure to do so can result in severe personal injury, death or electrical shock.

CAUTION

- **Be careful when you work on the Cooktop handling the sheet metal part.**
- **The 2 lock tabs on each ignitor switch are fragile. Tab breakage can occur if excessive release pressure is applied.**

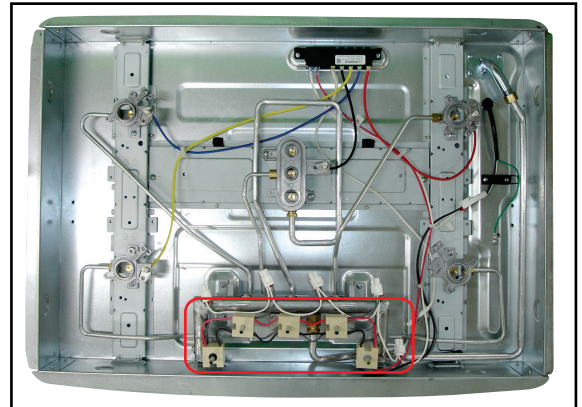

1. Remove the cooktop plate.(See “**Cooktop Plate**”.)
2. Remove the LED lamp module.(See “**LED Lamp Module**”.)
3. Carefully pry on the 2 release tabs and slide the switch off the valve stem.

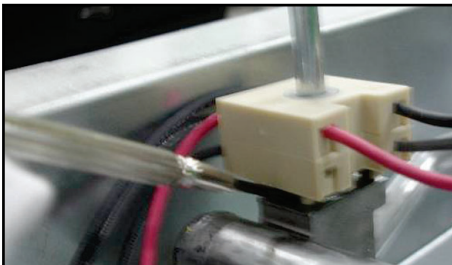

4. Disconnect the connectors of the ignition switch assembly.

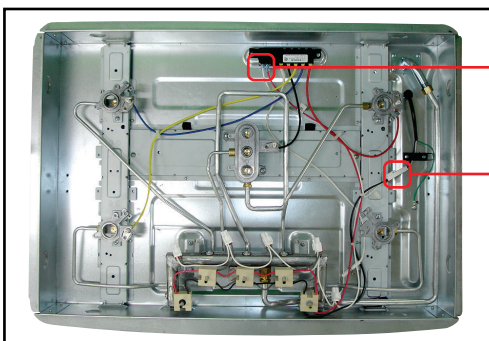

Connectors to Spark Module(I.G. Trans)

Connector to Power Cord

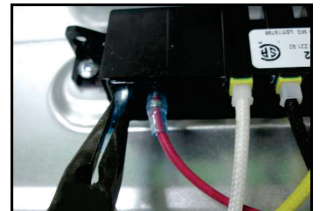

5. Remove the ignition switch assembly.

When replacing this part with new one, progress reversely.

COMPONENT REPLACEMENT

Single Burner Valve

⚠ WARNING

- **DISCONNECT** power supply before servicing.
- **SHUT OFF** gas supply to the cooktop before servicing.
- **Replace all panels and parts before operating.**
- **RECONNECT** all grounding devices.
- Failure to do so can result in severe personal injury, death or electrical shock.

⚠ CAUTION

- **Be careful when you work on the Cooktop handling the sheet metal part.**
- **Check that the gas seal gasket on the screw and the gas valve remain in place before installing the new gas valve.**

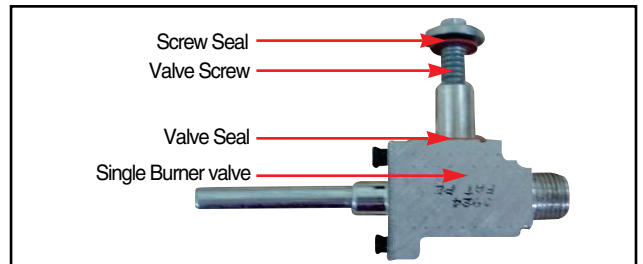
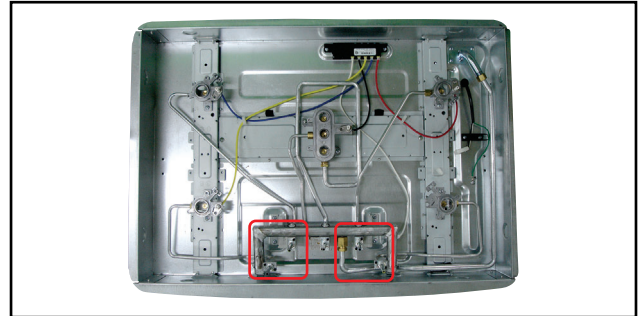

1. Remove the cooktop plate. (See “Cooktop Plate”.)
2. Remove the LED lamp module. (See “LED Lamp Module”.)
3. Remove the ignition switch assembly. (See “Ignition Switch Assembly”.)
4. Remove the 1/2 inch tubing from the gas valve outlet.

① Left Front Burner Valve (Violet)



② Left Rear Burner Valve (Green)

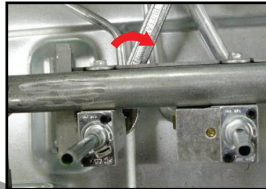

③ Right Front Burner Valve (Blue)



④ Right Rear Burner Valve (Yellow)

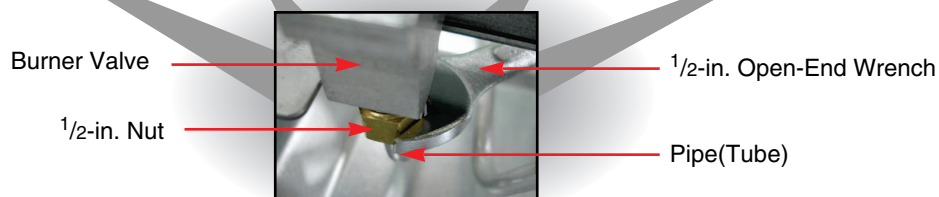
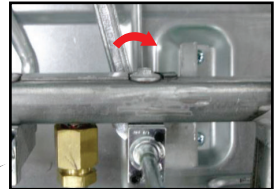

5. Unfasten the 1/2-in. hex head screw that holds the burner valve to the gas manifold the burner valve to the gas manifold.

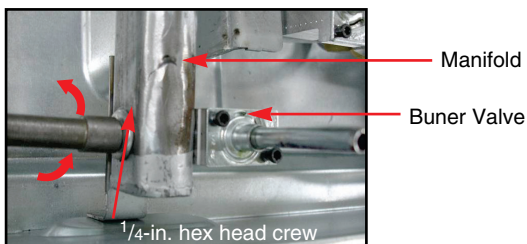

6. Remove the burner valve.

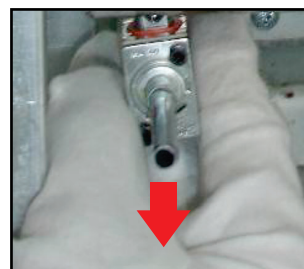

When replacing this part with new one, progress reversely.

COMPONENT REPLACEMENT

Double Burner Valve Assembly

⚠ WARNING

- **DISCONNECT** power supply before servicing.
- **SHUT OFF** gas supply to the cooktop before servicing.
- Replace all panels and parts before operating.
- **RECONNECT** all grounding devices.
- Failure to do so can result in severe personal injury, death or electrical shock.

⚠ CAUTION

- Be careful when you work on the Cooktop handling the sheet metal part.
- Check that the gas seal gasket on the screw and the gas valve remain in place before installing the new gas valve.

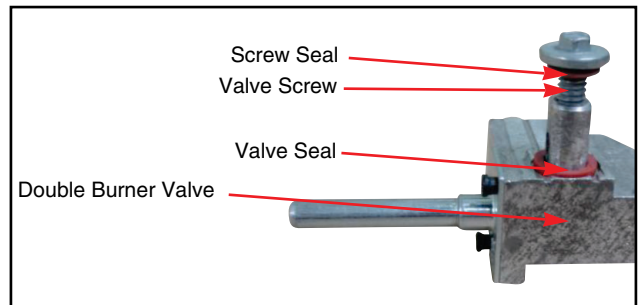
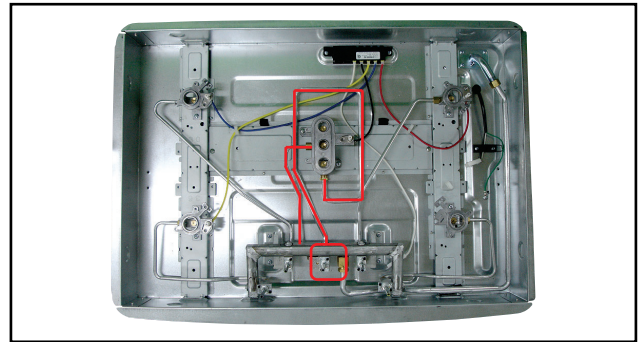

1. Remove the cooktop plate.(See “Cooktop Plate”.)
2. Remove the LED lamp module.(See “LED Lamp Module”.)
3. Remove the ignition switch assembly. (See “Ignition Switch Assembly”.)
4. Remove the 1/2 inch tubing fitting and the 9/16 inch tubing fitting from the burner gas housing.

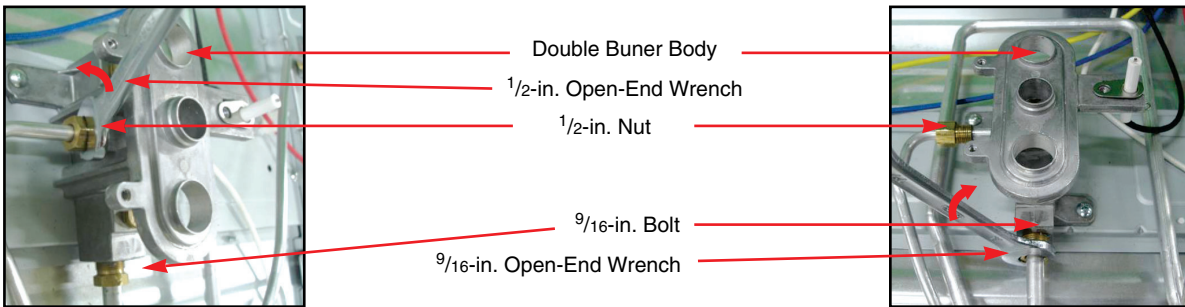

5. Unfasten the 1/2-in. hex head screw that holds the burner valve to the gas manifold.

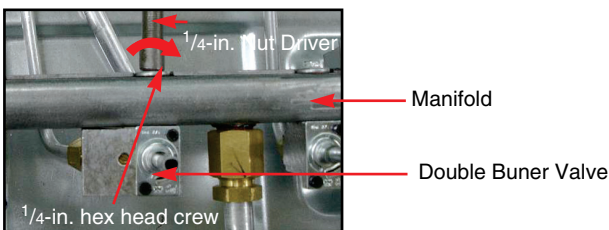

6. Remove the valve assembly carefully including the pipes(tubes).

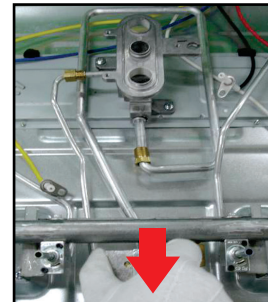

When replacing this part with new one, progress reversely.

COMPONENT REPLACEMENT

Burner Pipe Assembly

WARNING

- **DISCONNECT** power supply before servicing.
 - **SHUT OFF** gas supply to the cooktop before servicing.
 - Replace all panels and parts before operating.
 - **RECONNECT** all grounding devices.
- Failure to do so can result in severe personal injury, death or electrical shock.

CAUTION

- Be careful when you work on the Cooktop handling the sheet metal part.

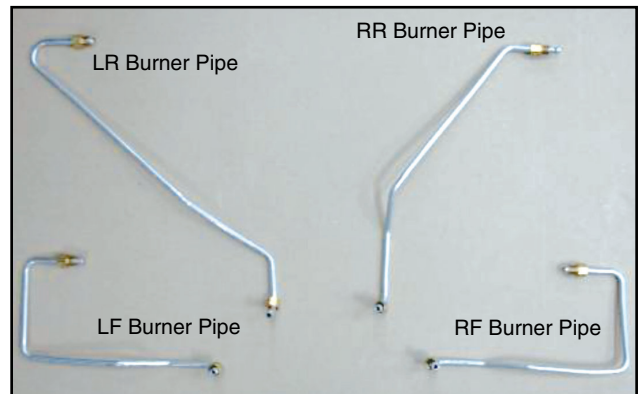

1. Remove the cooktop plate. (See “Cooktop Plate”.)
2. Remove the 1/2 inch tubing fittings from the burner gas housing.

① Left Front Burner Body

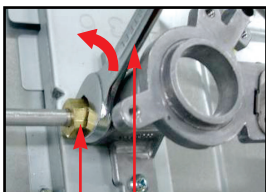

1/2-in. Nut 1/2-in. Open-End Wrench

② Left Rear Burner Body

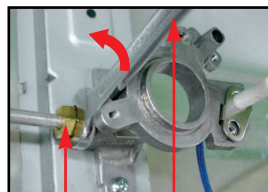

1/2-in. Nut 1/2-in. Open-End Wrench

③ Right Front Burner Body



1/2-in. Nut 1/2-in. Open-End Wrench

④ Right Rear Burner Body

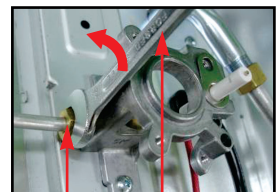

1/2-in. Nut 1/2-in. Open-End Wrench

3. Remove the tubing fittings from the gas valve.

① Left Front Burner Valve



② Left Rear Burner Valve

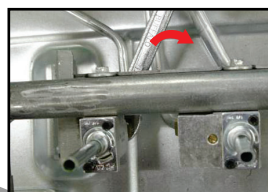

③ Right Front Burner Valve



④ Right Rear Burner Valve

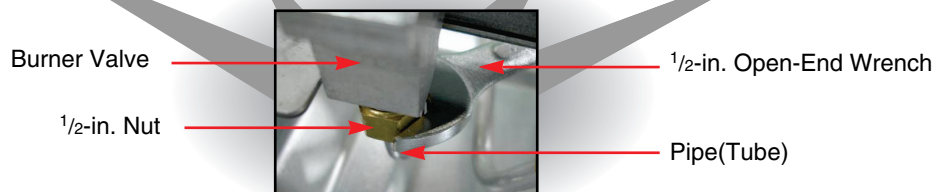

4. Lift the burner pipe assembly.

When replacing this part with new one, progress reversely.

COMPONENT REPLACEMENT

Manifold Pipe Assembly

WARNING

- **DISCONNECT** power supply before servicing.
- **SHUT OFF** gas supply to the cooktop before servicing.
- Replace all panels and parts before operating.
- **RECONNECT** all grounding devices.
- Failure to do so can result in severe personal injury, death or electrical shock.

CAUTION

- Be careful when you work on the Cooktop handling the sheet metal part.

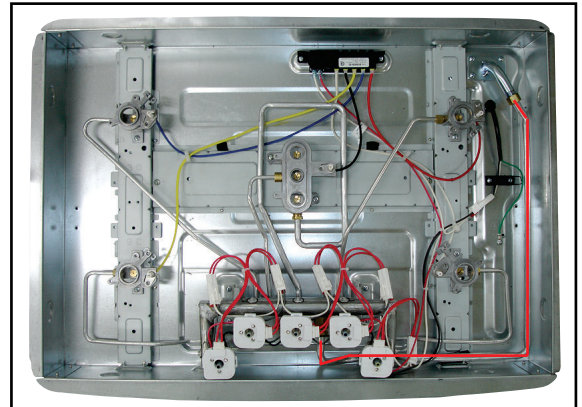

1. Remove the cooktop plate.(See “**Cooktop Plate**”.)
2. Unfasten the $1^{1/16}$ -in Nut from the inlet pipe assembly.

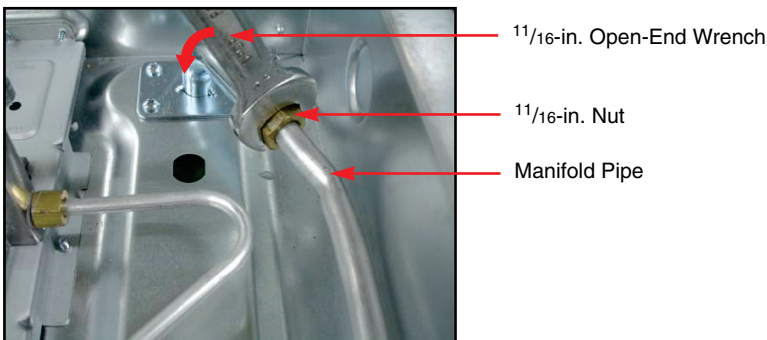

3. Unfasten the $1^{1/16}$ -in Bolt from the manifold assembly.

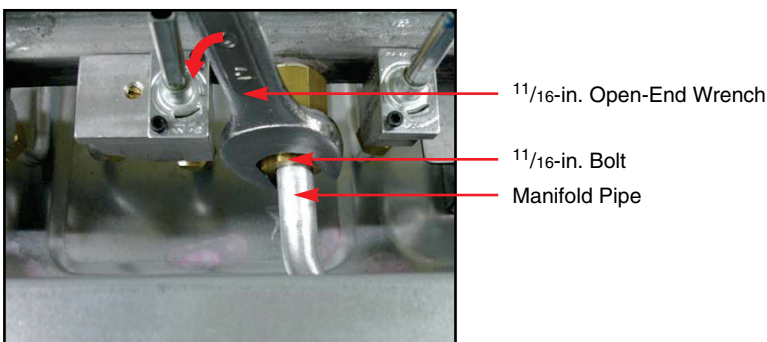

4. Lift the pipe assembly.

When replacing this part with new one, progress reversely.

COMPONENT REPLACEMENT

Manifold Assembly

WARNING

- **DISCONNECT** power supply before servicing.
- **SHUT OFF** gas supply to the cooktop before servicing.
- Replace all panels and parts before operating.
- **RECONNECT** all grounding devices.
- Failure to do so can result in severe personal injury, death or electrical shock.

CAUTION

- Be careful when you work on the Cooktop handling the sheet metal part.

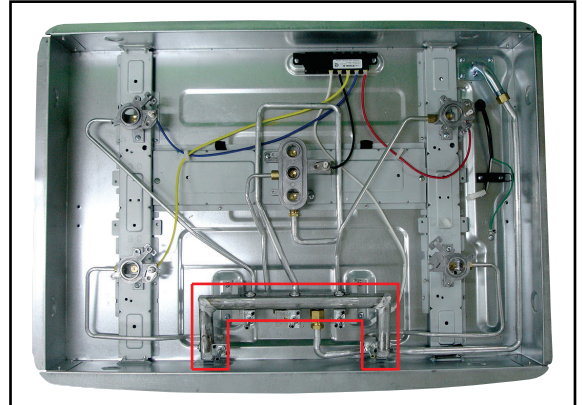

1. Remove the cooktop plate. (See “**Cooktop Plate**”.)
2. Remove the single burner valve and double burner valve assembly. (See “**Single Burner Valve**” and “**Double Burner Valve Assembly**”.)
3. Unfasten the $1\frac{1}{16}$ -in. bolt from the manifold assembly.

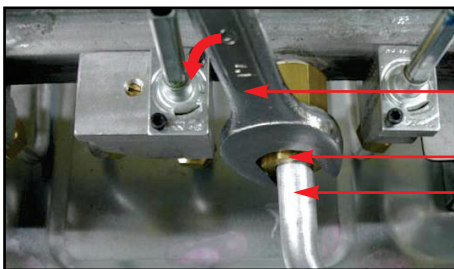

$1\frac{1}{16}$ -in. Open-End Wrench

$1\frac{1}{16}$ -in. Bolt

Manifold Pipe

4. Unfasten the 6 screws.

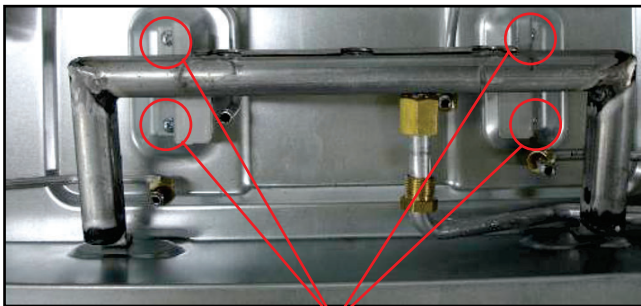

Phillips Head Screw

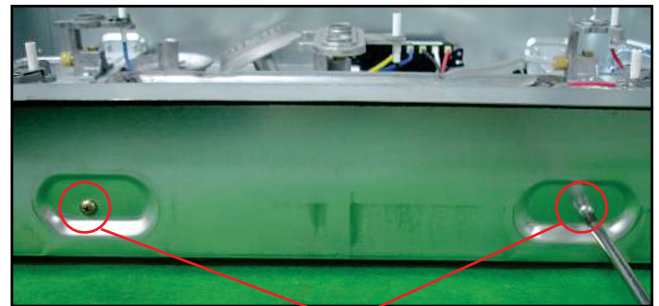

Phillips Head Screw

5. Lift the manifold assembly.

When replacing this part with new one, progress reversely.

COMPONENT REPLACEMENT

Inlet Pipe Assembly

WARNING

- **DISCONNECT** power supply before servicing.
 - **SHUT OFF** gas supply to the cooktop before servicing.
 - Replace all panels and parts before operating.
 - **RECONNECT** all grounding devices.
- Failure to do so can result in severe personal injury, death or electrical shock.

CAUTION

- Be careful when you work on the Cooktop handling the sheet metal part.

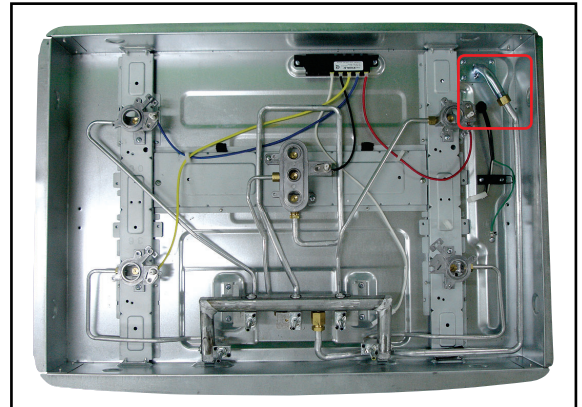

1. Remove the cooktop plate. (See “Cooktop Plate”.)
2. Unfasten the $1\frac{1}{16}$ -in. Nut from the inlet pipe assembly.

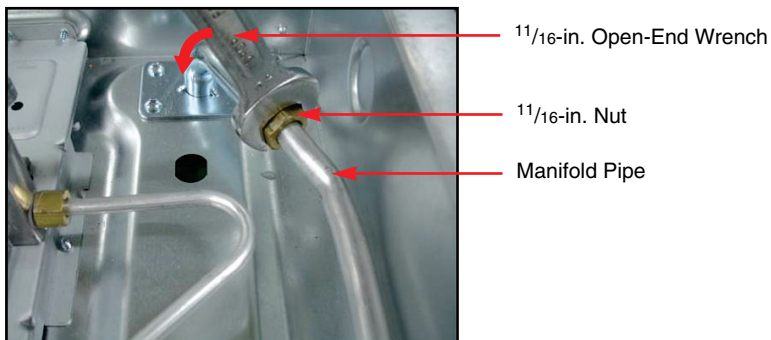

3. Unfasten the 4 screws.

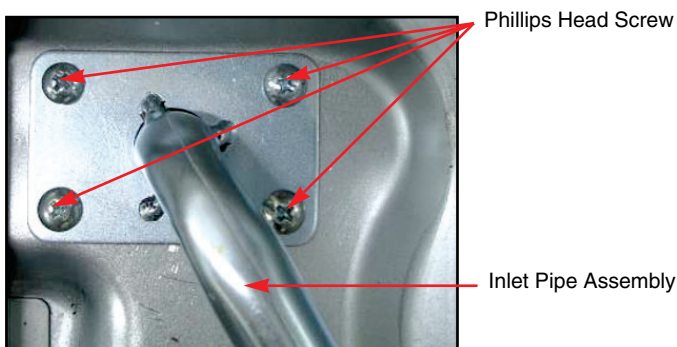

4. Lift the inlet pipe assembly



When replacing this part with new one, progress reversely.

COMPONENT REPLACEMENT

Center Burner Bracket

WARNING

- **DISCONNECT** power supply before servicing.
- **SHUT OFF** gas supply to the cooktop before servicing.
- Replace all panels and parts before operating.
- **RECONNECT** all grounding devices.
- Failure to do so can result in severe personal injury, death or electrical shock.

CAUTION

- Be careful when you work on the Cooktop handling the sheet metal part.

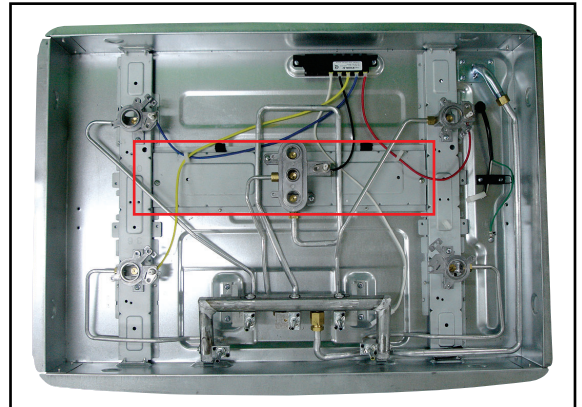

1. Remove the cooktop plate.(See “Cooktop Plate”.)
2. Remove the double burner body.(See “Double Burner Body”)
3. Unfasten the 6 screws.

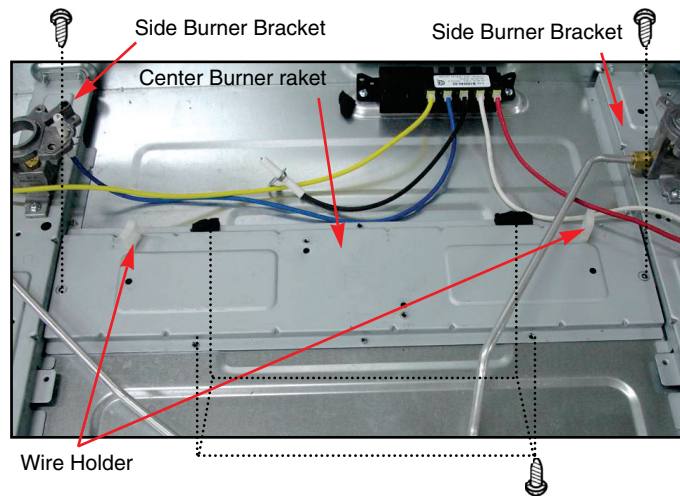

4. Lift the center burner bracket.



5. Remove the 2 wire holder.



When replacing this part with new one, progress reversly.

COMPONENT REPLACEMENT

Side Burner Bracket(Left and Right)

⚠ WARNING

- **DISCONNECT** power supply before servicing.
- **SHUT OFF** gas supply to the cooktop before servicing.
- **Replace all panels and parts before operating.**
- **RECONNECT** all grounding devices.
- Failure to do so can result in severe personal injury, death or electrical shock.

⚠ CAUTION

- **Be careful when you work on the Cooktop handling the sheet metal part.**

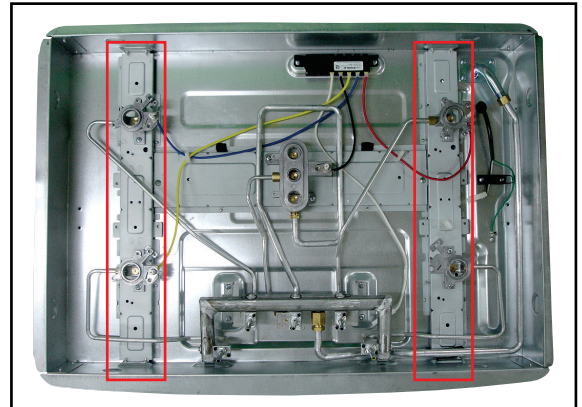

1. Remove the cooktop plate.(See “**Cooktop Plate**”.)
2. When removing the left side burner bracket, remove LF and LR burner body. When the right side burner bracket, remove RF and RR burner body. (See “**Single Burner Body**”)
3. Unfasten the 9 screws.

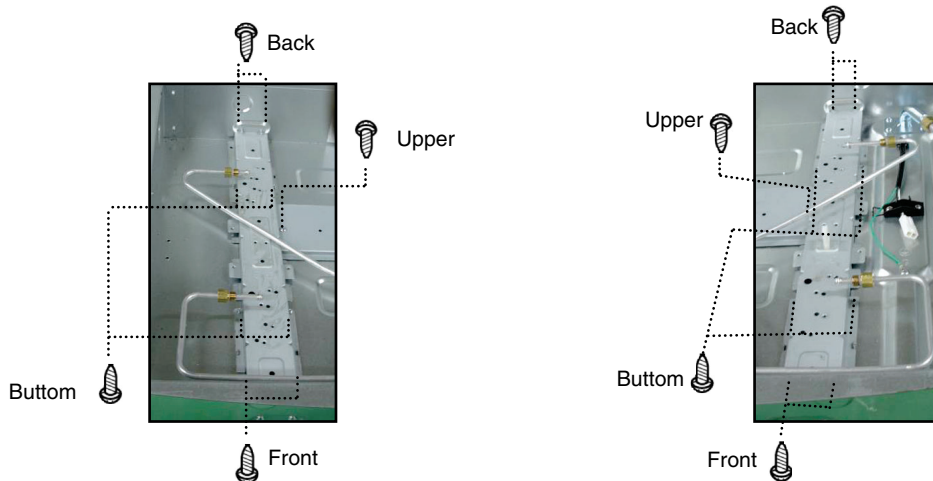

4. Lift the side burner bracket. - For the right burner bracket, remove the wire holder.

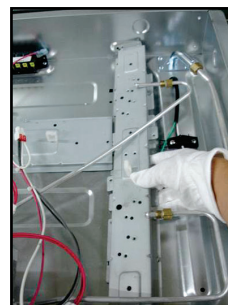

NOTE : For LRC3091ST, when servicing the this part, assemble this part to be seen ‘30’ mark rightly.
For LRC3691ST, when servicing the this part, assemble this part to be seen ‘36’ mark rightly.

When replacing this part with new one, progress reversely.

CONVERSION TO LP GAS

WARNING

- **DISCONNECT** power supply before servicing.
- **SHUT OFF** gas supply to the cooktop before servicing.
- **Replace all panels and parts before operating.**
- **RECONNECT all grounding devices.**
 - Failure to do so can result in severe personal injury, death or electrical shock.

CAUTION

- **Be careful when you work on the Cooktop handling the sheet metal part.**

1. CONVERTING THE REGULATOR

The regulator is located under the right hand corner of the cooktop.

- Unscrew the hex-nut cap by using an adjustable wrench.
- Separate plastic cap and hex-nut cap by turning the plastic cap to 90°.
- Install the plastic cap so that the solid end of the cap faces outward. (opposite as received for natural gas)
- Screw the hex-nut cap back into the regulator. Don't over tighten.

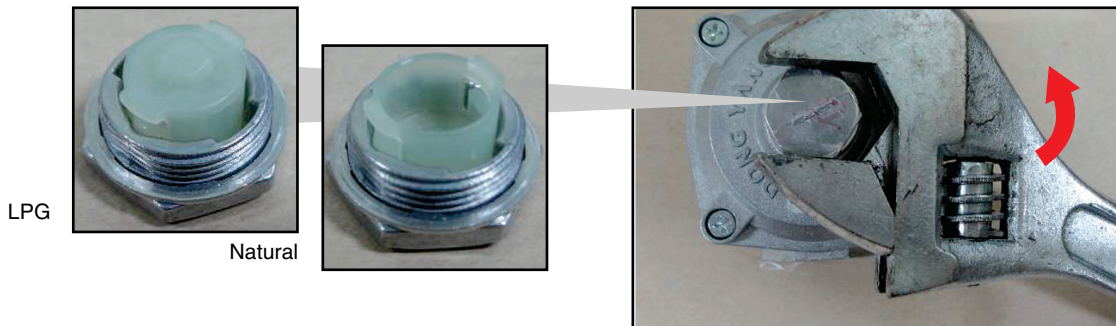

2. CONVERTING THE SURFACE BURNERS

LP orifice spuds have an orifice code on the top, denoting the location on the cooktop where it is to be installed.

- Remove grates, burner caps and burner heads.
- Remove the brass orifice spud in the chimney of each burner using a $1^{3/32}$ " or 10 mm Nut driver.

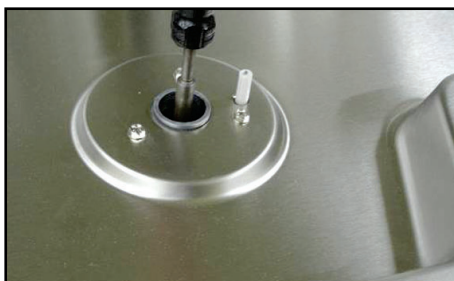

Return the natural gas orifices to the burner body and reattach the burner body and the instruction sheet to the pressure regulator using the screw removed previously.

CONVERSION TO LP GAS

- C. Install the LP orifice spuds into their correct positions as shown below picture and tables.
- D. To prevent leakage, make sure the orifice spuds are securely screwed into the gas supply tubes.
- E. For the Double burner(center) three orifice spuds will be need.

BURNER OUTPUT RATINGS;BTU/HR				
LP or Propane Gas, 10~W.C.P				
MODEL	BTU RATE		ORIFICE CODE	
	LCG3691ST	LCG3091ST	LCG3691ST	LCG3091ST
LF	9100	9100	F	F
LR	9100	9100	F	F
RR	5000	5000	G	G
RF	9500	9500	H	H
CTR	INNER	15000	15000	J
	OUTER			K

BURNER OUTPUT RATINGS;BTU/HR				
Natural Gas, 5" W.C.P				
MODEL	BTU RATE		ORIFICE CODE	
	LCG3691ST	LCG3091ST	LCG3691ST	LCG3091ST
LF	9100	9100	A	A
LR	9100	9100	A	A
RR	5000	5000	B	B
RF	12000	12000	C	C
CTR	INNER	19000	19000	D
	OUTER			E

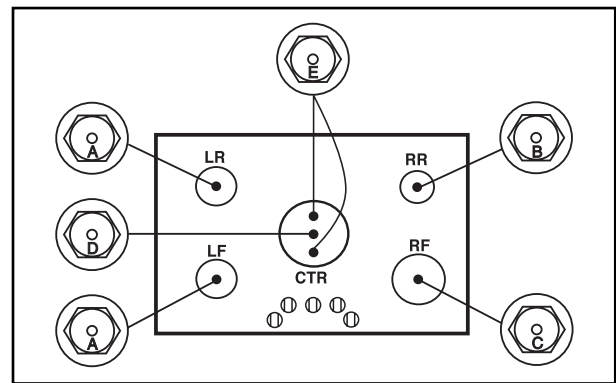
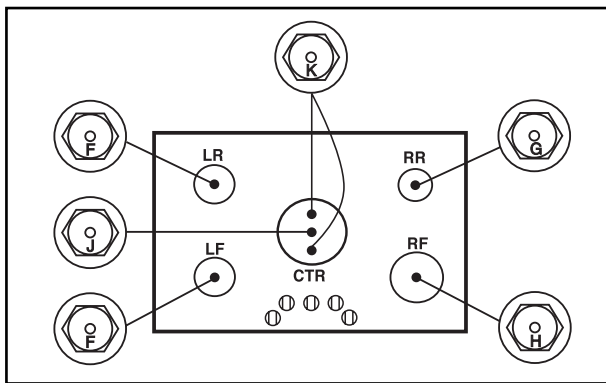

CONVERSION TO LP GAS

3. ADJUST THE SURFACE BURNER LOW FLAME (SIMMER) SETTING

For all surface burners except for the center burner

- A. Light all surface burners except for the center burner.
- B. Turn the knob on the burner being adjusted to “LO”(LOW).
- C. Remove knob.
- D. Insert a small, flat bladed screwdriver into the valve stem.
- E. Turn the adjustment screw until the flame reaches the desired size.
- F. Replace the knob.
- G. Test The Flame Stability.



Test 1:

- Turn the knob from “HI” to “LOW” quickly.
- If the flame goes out, increase the flame size and test again.

Test 2:

- With the burner on a “LOW” setting, open and close the oven or cabinet door quickly.
 - If the flame is extinguished by the air currents created by the door movement, increase the flame height and test again.
- H. Repeat steps A-F for each surface burner except for center burner.

Only For the center burner

- A. Disconnect power to appliance.
- B. Remove the cooktop plate.(See “Cooktop Plate”.)
- C. Remove LED lamp module of the center valve by unclipping. In this case, the ignition switch should be positioned properly.
- D. Replace the cooktop back and secure the screws of the cooktop.
- E. Position center burner head, center burner cap, center grate, center knob.
- F. Connect power to appliance.
- G. Light center burner.
- H. Turn the knob on the burner being adjusted to “LO”(LOW).
- I. Remove knob.
- J. Using a small, flat bladed screwdriver insert into the hole next to the valve stem to adjust outer flame.
- K. Turn the adjustment screw until the flame reaches the desired size.
- L. Replace the knob. Adjustment screw next to the valve shaft.
- M. Test The Flame Stability.

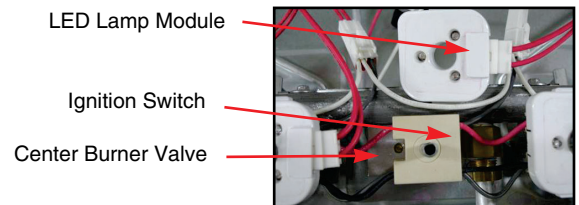

Test 1:

- Turn the knob from “HI” to “LOW” quickly.
- If the flame goes out, increase the flame size and test again.

CONVERSION TO LP GAS

Test 2:

- With the burner on a “LOW” setting, open and close the oven or cabinet door quickly.
- If the flame is extinguished by the air currents created by the door movement, increase the flame height and test again.

N. After low flame setting, turn off the burner.

O. Disconnect power to appliance.

P. Remove the cooktop plate.(See “**Cooktop Plate**”.)

Q. Reposition center LED lamp module by hooking.

R. Reposition cook top and secure all screws of cook top.

S. Reposition burner heads, burner caps, grates and knobs.

T. Connect power to appliance.

4. CONVERSION STICKER

Upon completion of conversion, fill out the LP sticker located with the instructions. Once complete, apply the sticker to the back of the cooktop near the regulator. If converting back to the natural gas from LP, remove the LP sticker from the back of the cooktop.

To convert to the original gas.

Follow conversion process with original orifices to convert the appliance to the original gas.

FAILURE MODE FLOW CHART

No Ignition

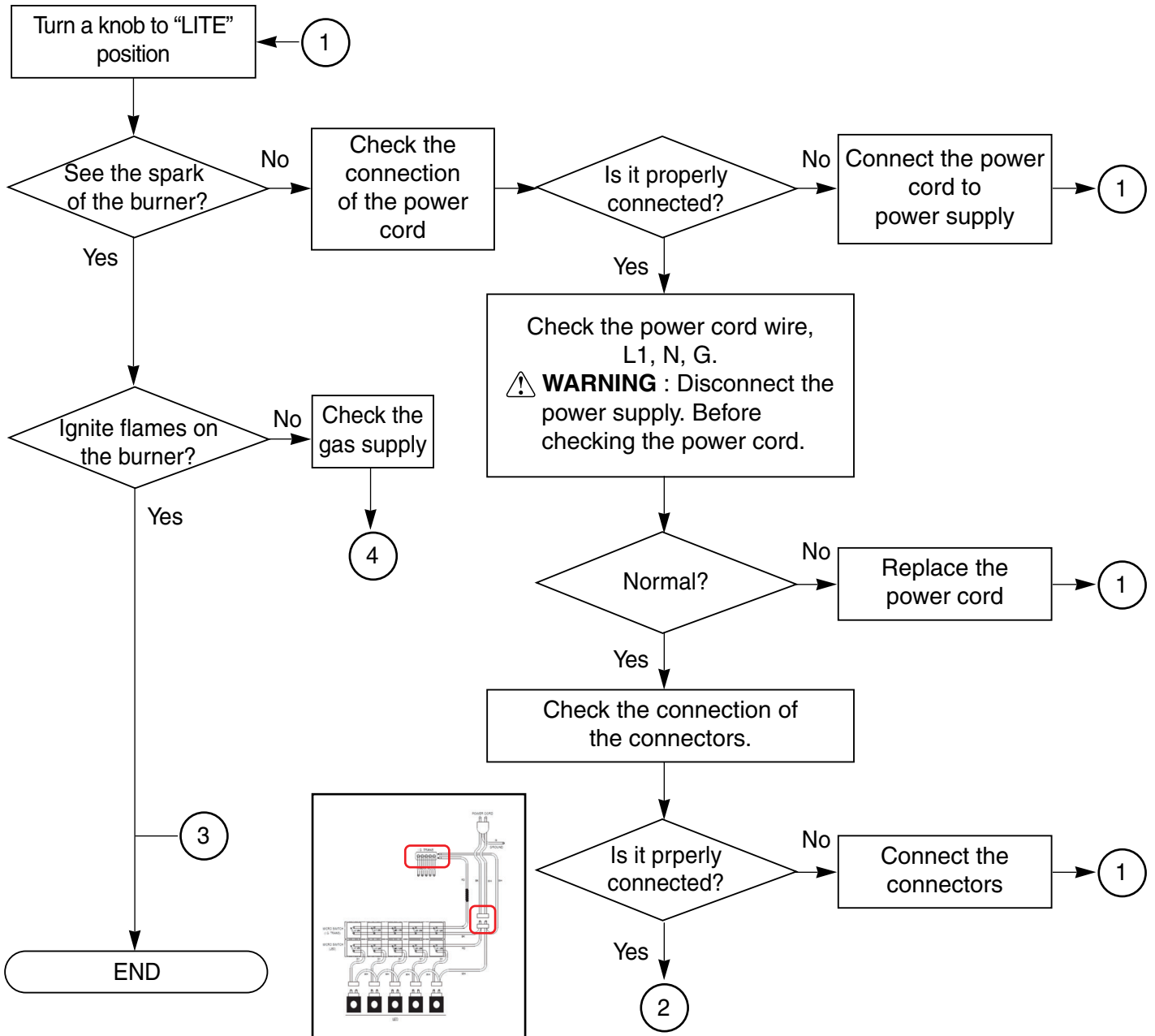

FAILURE MODE FLOW CHART

No Ignition

- ❶ Turn the knob to "LITE" Position.
- ❷ Then check the resistance of 5 switch shown as below.
- Normal : 0 Ω (A switch is closed.)

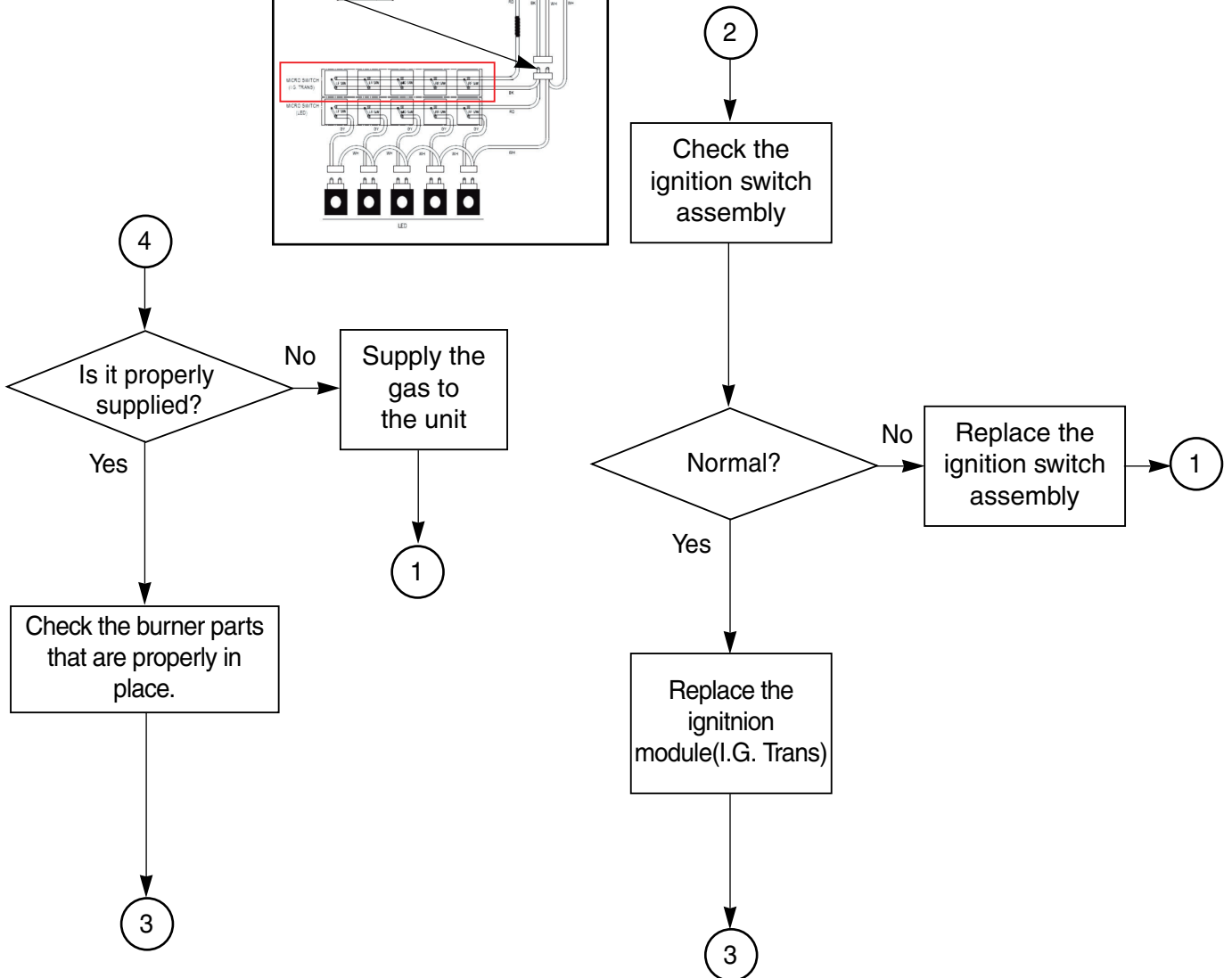
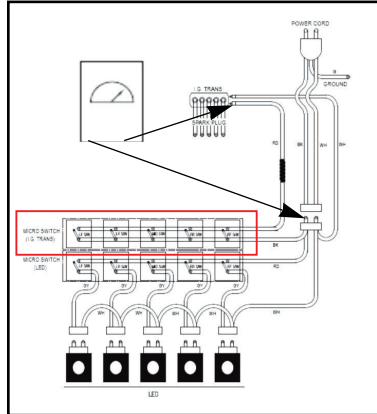

FAILURE MODE FLOW CHART

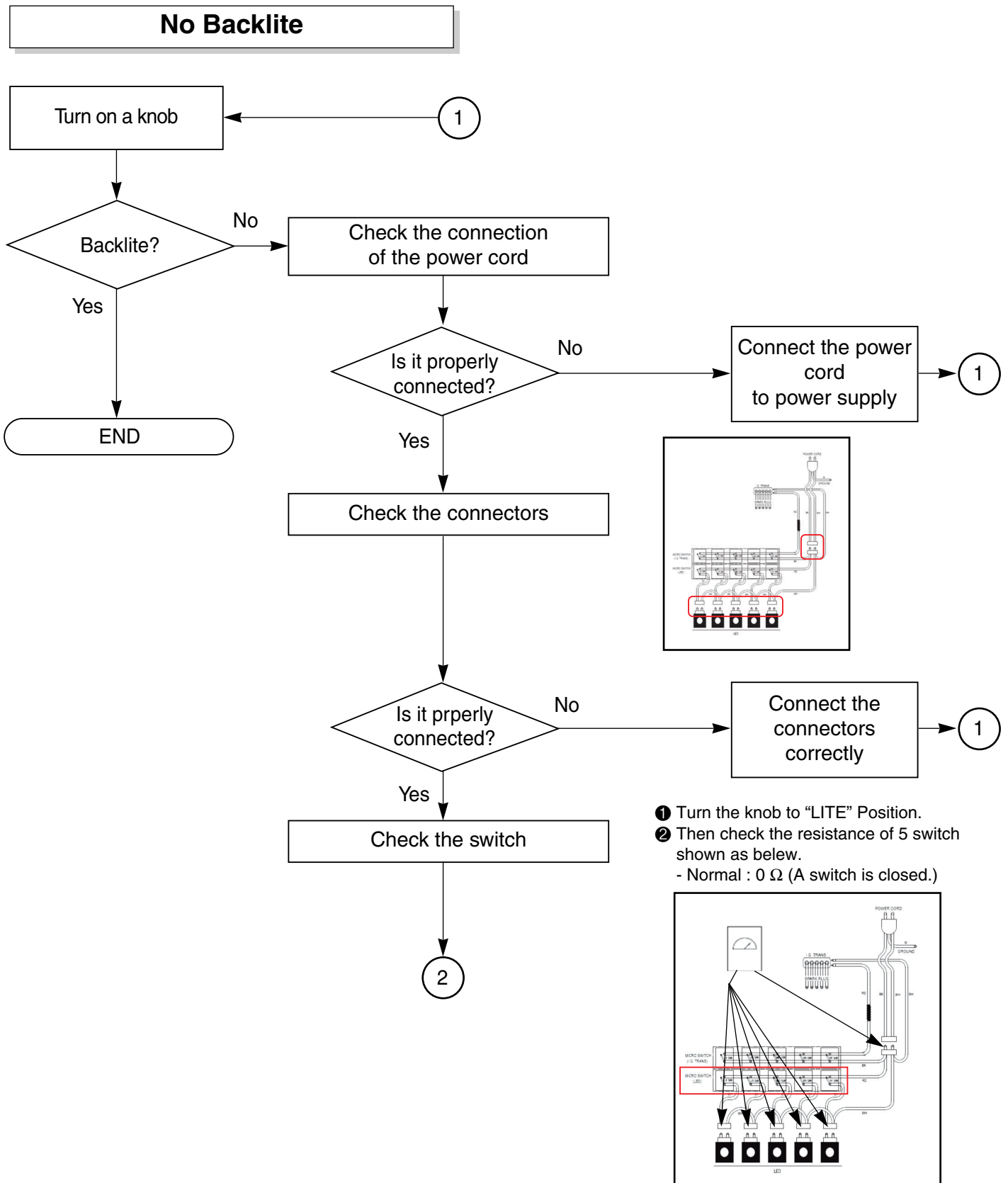

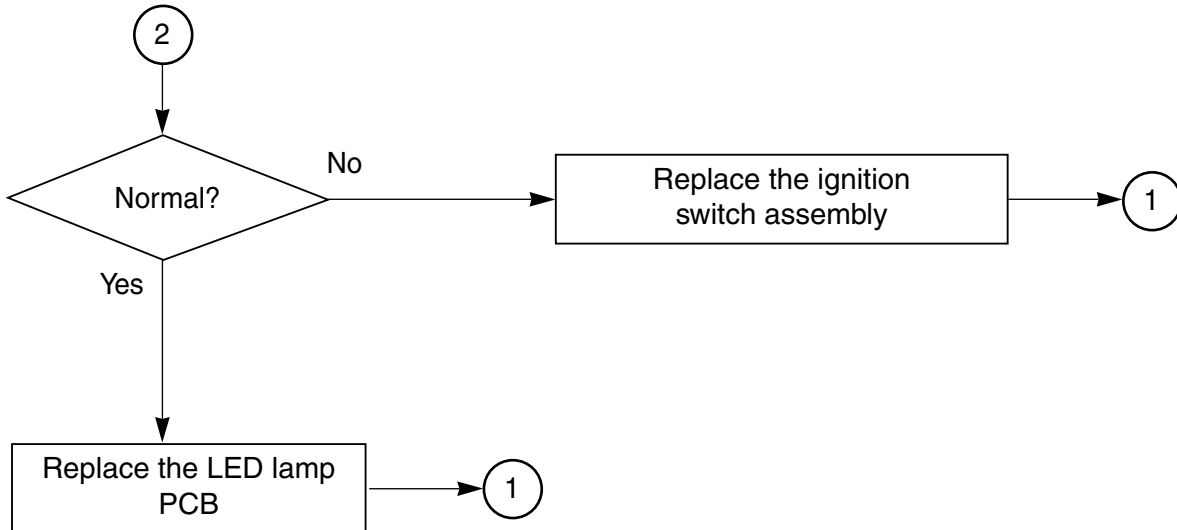

FAILURE MODE FLOW CHART

No Backlite



TROUBLE SHOOTING

Problem	Possible Causes	Solutions
<p>Burners have yellow or yellow-tipped flames</p>	<ul style="list-style-type: none"> • The combustion quality of burner flames needs to be determined visually. 	<ul style="list-style-type: none"> • Use the illustrations below to determine if your burner flames are normal. If burner flames look like A, call for service. Normal burner flames should look like B or C, depending on the type of gas you use. With LP gas, some yellow tipping on outer cones is normal. <div style="display: flex; justify-content: space-around; align-items: flex-start; text-align: center;"> <div style="margin: 10px;">  <p>A—Yellow flames Call for service</p> </div> <div style="margin: 10px;">  <p>B—Yellow tips on outer cones Normal for LP gas</p> </div> <div style="margin: 10px;">  <p>C—Soft blue flames Normal for natural gas</p> </div> </div>
<p>Burner flames are very large or have yellow</p>	<ul style="list-style-type: none"> • Improper air to gas ratio. 	<ul style="list-style-type: none"> • If cooktop is connected to LP gas, contact the person who installed your range or made the conversion.
<p>Control knobs will not turn</p>	<ul style="list-style-type: none"> • Knob is not pushed down. 	<ul style="list-style-type: none"> • To turn from OFF position, push the knob down and then turn.
<p>Top burners do not light or do not burn evenly.</p>	<ul style="list-style-type: none"> • Plug on cooktop is not completely inserted in the electrical outlet. • Burner slots on the side of the burner may be clogged. • Improper burner assembly. 	<ul style="list-style-type: none"> • Make sure electrical plug is plugged into a live, properly grounded outlet. • Remove the burners and clean them. Check the electrode area for burned-on food or grease. See the Care and Cleaning of the Cooktop section. • Make sure the burner parts are installed correctly. See the Care and Cleaning of the Cooktop section.

EXPLODED VIEW

MODEL: LCG3091ST
LCG3691ST

