

This Owner's Manual is provided and hosted by [Appliance Factory Parts](#).



LG LCG3691ST Owner's Manual

[Shop genuine replacement parts for LG LCG3691ST](#)



[Find Your LG Gas Range Parts - Select From 55 Models](#)

----- Manual continues below -----



GAS COOKTOP

INSTALLATION INSTRUCTIONS

Please read this guide thoroughly
before installation.

To contact LG Electronics, 24 hours a day,
7 days a week:

1-800-243-0000 (U.S.A.)

1-888-542-2623 (Canada)

Or visit us on the Web at:

us.lge.com (U.S.A.)

ca.lge.com (Canada)

BEFORE YOU BEGIN

Read these instructions completely
and carefully.

Installation of this cooktop must conform with local codes, or in the absence of local codes, with the National Fuel Gas Code, ANSI Z223.1/NFPA.54, latest edition. In Canada, installation must conform with the current Natural Gas Installation Code, CAN/CGAB149.1 or the current Propane Installation Code, CAN/CGA-B149.2, and with local codes where applicable. This cooktop has been design-certified by CSA International according to ANSI Z21.1, latest edition and Canadian Gas Association according to CAN/CGA-1.1 latest edition.

As with any appliance using gas and generating heat, there are certain safety precautions you should follow. You will find these precautions in the Important Safety Information section in your User's Guide. Read them carefully.

- **IMPORTANT** – Save these instructions for local electrical inspector's use.
- **IMPORTANT** – Observe all governing codes and ordinances.

Note to Installer: Leave these instructions with the appliance after installation is completed.

Note to Consumer: Keep the User's Guide and Installation Instructions for future reference.

NOTE: This appliance must be properly grounded.

- The electrical diagram is in an envelope attached to the back of the cooktop.
- Skill level – Installation of this appliance requires basic mechanical skills.
- Proper installation is the responsibility of the installer.
- Product failure due to improper installation is not covered under the Warranty.
- Remove all tape and packaging.
- Make sure the burners are properly seated and level.
- Take the accessory pack off of the cooktop.
- Check to be sure that no cooktop parts have come loose during shipping.

INSTALLATION INSTRUCTIONS

READ ALL INSTRUCTIONS BEFORE INSTALLATION

IN THE COMMONWEALTH OF MASSACHUSETTS

- This product must be installed by a licensed plumber or gas fitter.
- When using ball type gas shut-off valves, they shall be the T-handle type.
- A flexible gas connector, when used, must not exceed 3 feet in length.

FOR YOUR SAFETY

⚠ WARNING: If the information in this manual is not followed exactly, a fire or explosion may result causing property damage, personal injury or death.

-Do not store or use combustible materials, gasoline or other flammable vapors and liquids in the vicinity of this or any other appliance.

WHAT TO DO IF YOU SMELL GAS

- Do not try to light any appliance.
- Do not touch any electrical switches,
- Do not use any phone in your building.
- Immediately call your gas supplier from a neighbor's phone. Follow the gas supplier instructions.
- If you cannot contact your gas supplier, call the fire department.

Installation and service must be performed by a qualified installer, service agency or the gas supplier.

PREPARING FOR INSTALLATION

TOOLS YOU WILL NEED

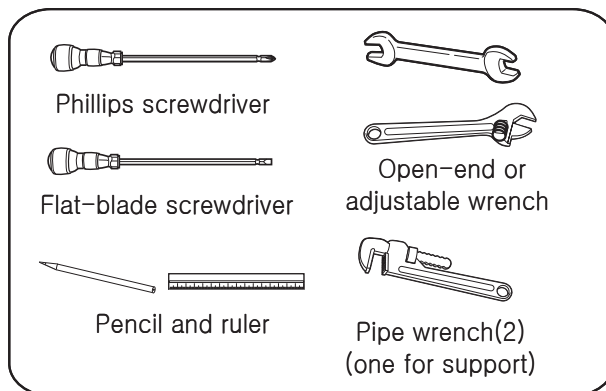

MATERIALS YOU MAY NEED

- Gas line shut-off valve
- To reduce the possibility of gas leaks, apply teflon tape or a thread compound approved for use with LP or Natural gases to all threaded connections.
- Flexible metal appliance connector (5/8" I.D.)
A 3-foot length is recommended for ease of installation but other lengths are acceptable. Never use an old connector when installing a new cooktop.
- Flare union adapter for connection to gas supply line (3/4" or 1/2" NPT x 5/8" I.D.)
- Flare union adapter for connection to pressure regulator on cooktop. (1/4" NPT x 1/2" I.D.)
- Liquid leak detector or soapy water.

MATERIALS YOU MAY NEED

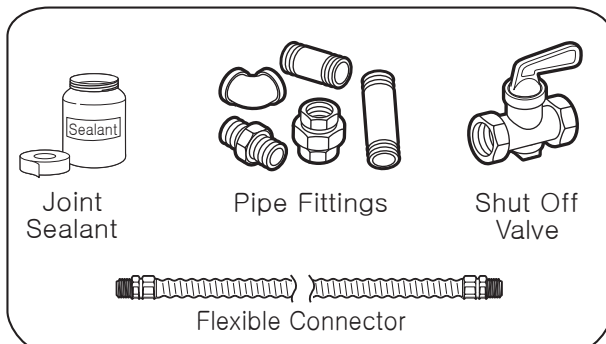

INSTALLATION INSTRUCTIONS

INSTALLATION SAFETY INSTRUCTIONS

BEFORE YOU BEGIN

Remove all tape and packing materials before using the cooktop. Dispose all plastic bags after unpacking the cooktop. Never allow children to play with packing materials.

IMPORTANT SAFETY INSTRUCTIONS

Read these instructions completely and carefully. Improper installation, adjustment, alteration, service or maintenance can cause injury or property damage.

For assistance or additional information, consult a qualified installer, service agency, manufacturer (dealer) or your gas supplier.

Never reuse old flexible connectors. The use of old flexible connectors can cause gas leaks and personal injury. Always use NEW flexible connectors when installing a gas appliance.



This is the safety alert symbol. This symbol alerts you to potential hazards that can kill or hurt you and others. All safety messages will follow the safety alert symbol and either the word “WARNING” or “CAUTION”.



WARNING

This symbol will alert you to hazards or unsafe practices which could cause serious bodily harm or death.



CAUTION

This symbol will alert you to hazards or unsafe practices which could cause bodily injury or property damage.

IMPORTANT: Remove all packing material and literature before connecting gas and electrical supply.

- Let your cooktop installed by a qualified installer.
- Your cooktop must be electrically grounded in accordance with local codes or, in the absence of local codes, in accordance with the National Electrical Code (ANSI/NFPA 70, latest edition). In Canada, electrical grounding must be in accordance with the current CSA C22.1 Canadian Electrical Code Part 1 and/or local codes. Refer to “3. Electrical Connections” in this manual.
- Be sure the wall coverings around the cooktop can withstand heat generated by the cooktop up to 200°F.
- Avoid placing cabinets above the cooktop. To minimize the hazard caused by reaching over the open flames of operating burners, install a ventilation hood over the cooktop that projects forward at least 5” beyond the front of the cabinets.

INSTALLATION INSTRUCTIONS

INSTALLATION SAFETY INSTRUCTIONS (continued)

- The ventilating hood must be constructed of sheet metal not less than 0.0122" thick. Install above the cooktop with a clearance of not less than 1/4" between the hood and the underside of the combustible material or metal cabinet. The hood must be at least as wide as the appliance and centered over the appliance. Clearance between the cooking surface and the ventilation hood surface MUST NEVER BE LESS THAN 24 INCHES.
- The vertical distance from the plane of the cooking surface to the bottom of adjacent overhead cabinets extending closer than 1" to the plane of the cooktop sides must not be less than 18". (See the Dimensions and Clearances illustration in this manual.)
- Do not obstruct the combustion or ventilation air.
- Leak testing of the appliance shall be conducted according to the manufacturer's instructions.

EXCEPTION: Installation of a listed microwave oven or cooking appliance over the cooktop shall conform to the installation instructions packed with that appliance.

- If cabinets are located above the cooktop, allow a minimum clearance of 30" between the cooking surface and the bottom of unprotected cabinets.
- If a 30" clearance between cooking surface and overhead combustible material or metal cabinets cannot be maintained, protect the underside of the cabinets above the cooktop with not less than 1/4" insulating millboard covered with sheet metal not less than 0.0122" thick. Clearance between the cooking surface and protected cabinets MUST NEVER BE LESS THAN 24 INCHES.

 **CAUTION:** Items of interest to children should not be placed in cabinets above the cooktop. – children climbing on the cooktop to reach items could be seriously injured.

INSTALLATION INSTRUCTIONS

DIMENSIONS AND CLEARANCES

Provide enough clearances between the cooktop and adjacent combustible surfaces. These dimensions must be met for safe use of your cooktop. The location of the electrical outlet and pipe opening may be adjusted to meet specific requirements.

The cooktop may be placed with 2 3/4" clearance to the back wall.

1. MAINTAIN THE FOLLOWING MINIMUM CLEARANCE DIMENSIONS

13" MAX. Depth of unprotected overhead cabinets

30" MIN. clearance from countertop to unprotected overhead surface

A" MIN. clearance from cutout to side wall on the left of unit.

A" MIN. clearance from cutout to side wall on the right of the unit

18" MIN. height from countertop to nearest cabinet on either side of unit

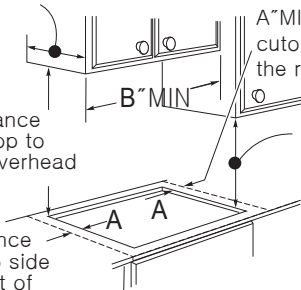

2. COOKTOP AND CUTOUT DIMENSIONS

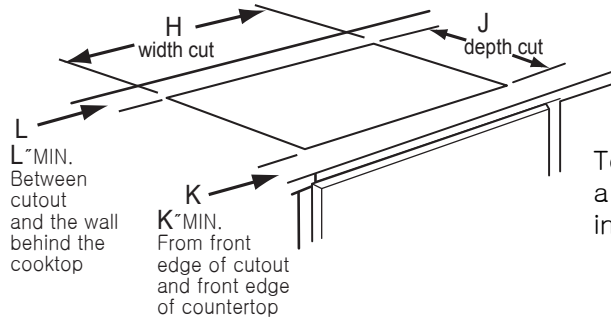
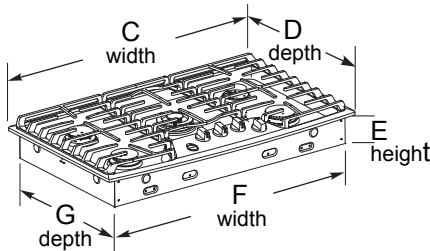

L" MIN. Between cutout and the wall behind the cooktop

K" MIN. From front edge of cutout and front edge of countertop

To ensure accuracy, it is best to make a template when cutting the opening in the counter

3. RECOMMENDED GAS SUPPLY LOCATION FROM BACKWALL

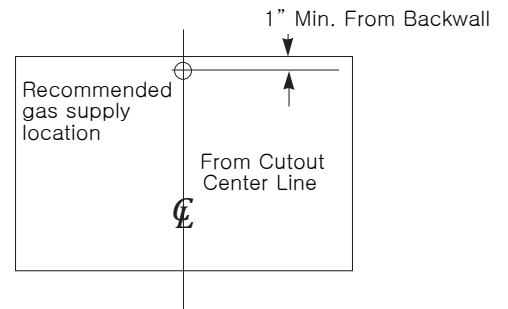

4. MAKE SURE WALL COVERINGS, COUNTERTOP AND CABINETS AROUND COOKTOP CAN WITHSTAND HEAT (UP TO 200°F) GENERATED BY COOKTOP

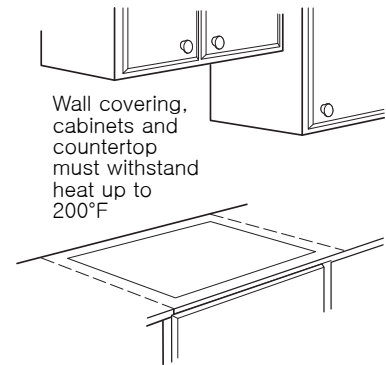

Wall covering, cabinets and countertop must withstand heat up to 200°F

MODEL	A	B	C	D	E	F	G	H	J	K	L
30" Cooktop	11 ¹³ / ₁₆ "	30"	30"	21 ¹ / ₁₆ "	3 ³ / ₄ "	28 ¹ / ₄ "	19 ³ / ₈ "	28 ¹ / ₂ "	19 ¹ / ₁₆ "	1 ⁵ / ₈ "	2 ³ / ₄ "
36" Cooktop	11 ¹³ / ₁₆ "	36"	36"	21 ¹ / ₁₆ "	3 ³ / ₄ "	33 ⁵ / ₈ "	19 ³ / ₈ "	33 ¹⁵ / ₁₆ "	19 ¹ / ₁₆ "	1 ⁵ / ₈ "	2 ³ / ₄ "

INSTALLATION INSTRUCTIONS

INSTALLING THE COOKTOP UNIT

1. LOCATE ELECTRICAL OUTLET AND GAS SHUT-OFF VALVE BENEATH CABINET

NEVER RE-USE OLD FLEX CONNECTORS.

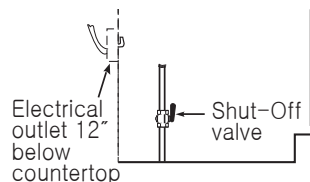

Install a manual shut-off valve in the gas line in an easily accessible location outside the cooktop. Be sure you know how and where to shut off the gas supply to the cooktop. Install the electrical outlet 12" below the countertop.

2. INSERT COOKTOP INTO CUTOUT

Insert the cooktop centered into the cutout opening. Be sure the front edge of the countertop is parallel to the cooktop. Make final check that all required clearances are met.

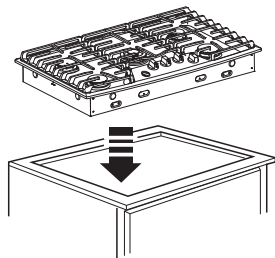

3. LOCATE RETAINER BRACKETS

Remove the retainer brackets from the literature package.

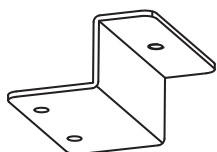

4. INSTALL THE RETAINER BRACKETS

Install the retainer brackets to the bottom of the cooktop unit. then snug the bolts against the bottom of the countertop as shown

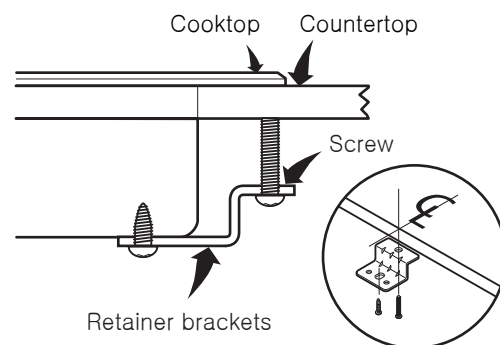
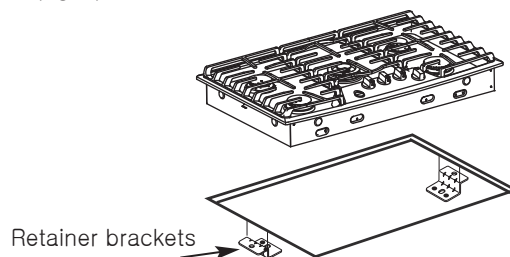

NOTE: The retainer brackets MUST be installed to meet local codes or, in their absence, with the National Electrical Code ANSI/NFPA No. 70, latest edition.

INSTALLATION INSTRUCTIONS

1. PROVIDE ADEQUATE GAS SUPPLY

This cooktop is designed to operate at a pressure of 5" of water column on natural gas or 10" of water column on LP, propane or butane gas.

Make sure you are supplying your cooktop with the type of gas for which it is designed.

This cooktop is convertible for use on natural or propane gas. When using this cooktop on LP gas, conversion must be made by a qualified LP installer before attempting to operate the cooktop on that gas.

For correct operation, the pressure of natural gas supplied to the regulator should be between 5" and 13" of water column.

For LP gas, the pressure supplied must be between 10" and 13" of water column.

When checking for correct operation of the regulator, the inlet pressure must be at least 1" more than the operating –manifold– pressure as given above.

The pressure regulator located at the inlet of the cooktop manifold must remain in the supply line regardless of whether natural or LP gas is being used.

A flexible metal appliance connector used to connect the cooktop to the gas supply line must have an I.D. of 5/8" and can be 3 feet in length easily for installation. In Canada, flexible connectors should be single wall metal connectors less than 6 feet in length.

2. CONNECT THE COOKTOP TO GAS

Shut off the main gas supply valve before removing the old cooktop and leave it off until the new hook-up has been completed. Don't forget to relight the pilot on other gas appliances when you turn the gas back on.

Because hard piping restricts movement of the cooktop, the use of a CSA International-certified flexible metal appliance connector is recommended unless local codes require a hard-piped connection.

Never reuse an old connector when installing a new cooktop. If the hard piping method is used, you must carefully align the pipe; the cooktop cannot be moved after the connection is made.

To protect gas leaks, put pipe joint compound on, all male –external– pipe threads.

- 1 Install a manual gas line shut-off valve in the gas line in an easily accessed location outside of the cooktop. Be sure everyone operating the cooktop knows where and how to shut off the gas supply to the cooktop.
- 2 Install male 1/2" flare union adapter to the 1/2" NPT internal thread at inlet of pressure regulator. Use a backup wrench on the pressure regulator fitting to prevent damage.

- 3 Install male 1/2" or 3/4" flare union adapter to the NPT internal thread of the manual shut-off valve, taking care to back-up the shut-off valve to keep it from turning.

- 4 Connect flexible metal connector to the adapter on the cooktop. Position cooktop to permit connection at the shut-off valve.

- 5 When all connections have been made, be sure all cooktop controls are in the off position and turn on the main gas supply valve. Check gas leaks by using manometer. If a manometer is not available, turn the gas supply on to the cooktop and use a liquid leak detector at all joints and connections to check for leak. Tighten all connections if necessary to prevent gas leakage in the cooktop or supply line.

⚠ WARNING!

DO NOT USE A FLAME TO CHECK FOR GAS LEAKS. Disconnect the cooktop and its individual shut-off valve from the gas supply piping system during any pressure testing of that system at test pressures more than 1/2 psig(3.5kPa). Isolate the cooktop from the gas supply piping system by closing its individual shut-off valve during any pressure testing of the gas supply system at test pressures equal to or less than 1/2 psig(3.5kPa)

INSTALLATION INSTRUCTIONS

FLEXIBLE CONNECTOR HOOKUP

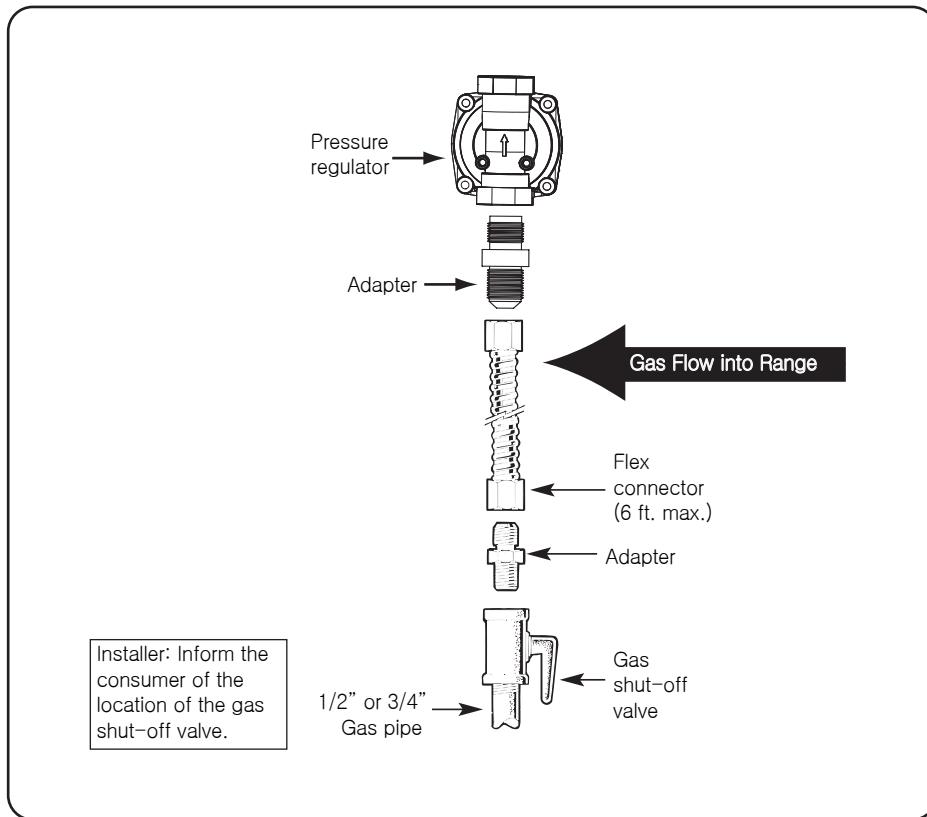

INSTALLATION INSTRUCTIONS

3. ELECTRICAL CONNECTIONS

ELECTRICAL REQUIREMENTS

120 Volt, 60 Hertz, properly grounded dedicated circuit protected by a 15 A or 20 A circuit breaker or time delay fuse.

GROUNDING

IMPORTANT: FOR PERSONAL SAFETY, THIS APPLIANCE MUST BE PROPERLY GROUNDED.

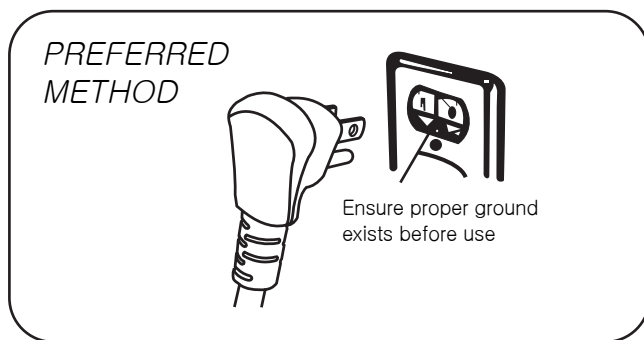

The power cord of this appliance should be equipped with a three-prong (grounding) plug which mates with a standard three-prong grounding wall receptacle to reduce the possibility of electric shock hazard from this appliance.

The customer should have the wall receptacle and circuit checked by a qualified technician to be sure the receptacle is properly grounded.

When connecting the cord of this cooktop to a standard two-prong wall receptacle, it is the personal responsibility and obligation of the customer to have it replaced with a properly grounded three-prong wall receptacle.

DO NOT, UNDER ANY CIRCUMSTANCES, CUT OR REMOVE THE THIRD (GROUND) PRONG FROM THE POWER CORD.

A word about Ground Fault Circuit Interrupters – Ground Fault Circuit Interrupters are not required or recommended for gas range receptacles.

Ground Fault Circuit Interrupters are devices that sense leakage of current in a circuit and automatically switch off power when a threshold leakage level is detected.

These devices must be manually reset by the customer.

The National Electrical Code requires the use of Ground Fault Circuit Interrupters in kitchen receptacles installed to serve countertop surfaces. Performance of the cooktop will not be affected if it is operated from a Ground Fault Circuit Interrupters protected circuit but occasional nuisance can occur.

INSTALLATION INSTRUCTIONS

3. ELECTRICAL CONNECTIONS (continued)

CAUTION

The customer should have the circuit checked by a qualified technician to make sure the receptacle is correctly grounded.

DO NOT use an adapter plug because disconnecting of the power cord places undue strain on the adapter and causes eventual failure of the adapter ground terminal.

The customer must have the two-prong wall receptacle replaced with a three-prong (grounding) receptacle by a qualified technician before using this cooktop.

The installation of appliances designed for mobile home installation should conform with the Manufactured Home Construction and Safety Standard, Title 24 CFR, Part 3280 (formerly the Federal Standard for Mobile Home Construction and Safety, Title 24, HUD, Part 280) or, when such standard is not applicable, the Standard for Manufactured Home Installations, latest edition (Manufactured Home Sites, Communities and Set-Ups), ANSI A225.1, latest edition, or with local codes. In Canada, mobile home installation must comply with the current CAN/CSA Z240/MH Mobile Home Installation Code.

4. SEAL THE OPENINGS

Seal any openings in the wall behind the cooktop and in the floor of the cabinet when hookups are completed.

INSTALLATION INSTRUCTIONS

5. ASSEMBLE THE SURFACE BURNERS

⚠ CAUTION

DO NOT operate the burners without all parts in place.

Place the burner caps and heads on the cooktop.

Make sure that the caps and heads are placed in the correct locations.

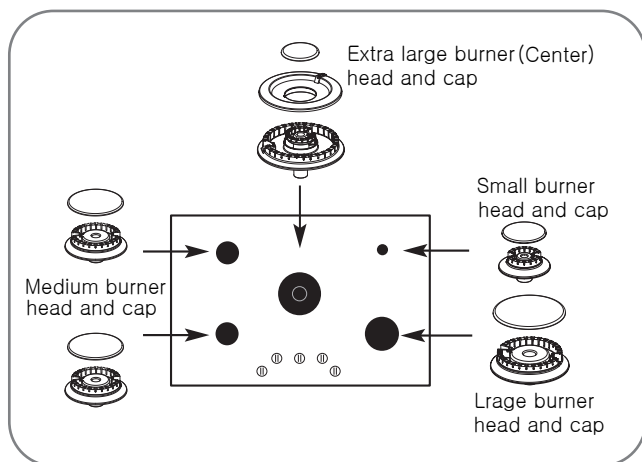

Make sure the hole in the burner head is positioned over the electrode.

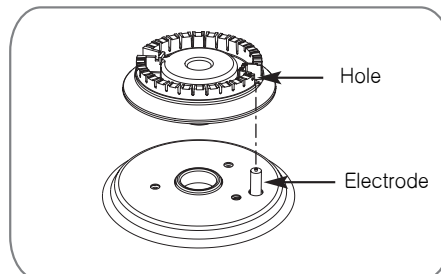

6. CHECK IGNITION OF SURFACE BURNERS

Operation of all cooktop burners should be checked after the COOKTOP and gas supply lines have been carefully checked for leaks.

ELECTRIC IGNITION

Select a top burner knob, push down and then turn counterclockwise to the "LITE" position.

You can hear a clicking sound indicating proper operation of the spark module.

Once the air has been purged from the supply lines, burner should ignite within 4 seconds.

After burner ignites, rotate knob out of the "LITE" position. Try each burner in succession until all burners have been checked.

QUALITY OF FLAMES

The combustion quality of burner flames needs to be confirmed visually.

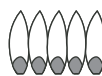

A Yellow flames — Call for service

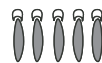

B Yellow tips on outer cones
— It is normal for LP gas



C Soft blue flames
— It is normal for natural gas

If burner flames look like A, call for service. B or C is normal burner flames, depending on the type of gas you use.

With LP gas, some yellow tipping on outer cones is normal.

INSTALLATION INSTRUCTIONS

7. ADJUST THE SURFACE BURNER LOW FLAME (SIMMER) SETTING

For all surface burners except for the center burner

1. Light all surface burners except for the center burner.
2. Turn the knob on the burner being adjusted to "LO"(LOW).
3. Remove knob.
4. Insert a small, flat bladed screwdriver into the valve stem as shown in Fig.2.
5. Turn the adjustment screw until the flame reaches the desired size.
6. Replace the knob.

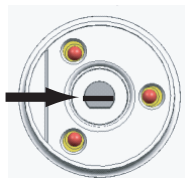

Center adjustment screw

Fig. 2

7. Test The Flame Stability.

Test 1 :

- Turn the knob from "HI" to "LOW" quickly.
- If the flame goes out, increase the flame size and test again.

Test 2 :

- With the burner on a "LOW" setting, open and close the oven or cabinet door quickly.
- If the flame is extinguished by the air currents created by the door movement, increase the flame height and test again.

8. Repeat steps 1 – 6 for each surface burner except for center burner.

Only For the center burner

1. Disconnect power to appliance.
2. Remove grates, burners caps, burner heads and knobs.
3. Remove the all the screws on the cooktop by philips screwdriver.
4. Remove cooktop by lifting up.
5. Remove LED lamp module of the center valve by unclipping. In this case, the ignition switch should be positioned properly.
6. Replace the cooktop back and secure the screws of the cooktop.

7. Position center burner head, center burner cap, center grate, center knob.
8. Connect power to appliance.
9. Light center burner.
10. Turn the knob on the burner being adjusted to "LO"(LOW).
11. Remove knob.
12. Using a small, flat bladed screwdriver insert into the hole next to the valve stem to adjust outer flame as shown in Fig.3.
13. Turn the adjustment screw until the flame reaches the desired size.
14. Replace the knob.

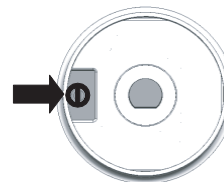

Adjustment screw next to the valve shaft

Fig. 3

15. Test The Flame Stability.

Test 1 :

- Turn the knob from "HI" to "LOW" quickly.
- If the flame goes out, increase the flame size and test again.

Test 2 :

- With the burner on a "LOW" setting, open and close the oven or cabinet door quickly.
- If the flame is extinguished by the air currents created by the door movement, increase the flame height and test again.

16. After low flame setting, turn off the burner.
17. Disconnect power to appliance.
18. Remove knob, grate, burner cap, burner head.
19. Remove all screw of the cook top.
20. Remove cook top by lifting up.
21. Reposition center LED lamp module by hooking.
22. Reposition cook top and secure all screws of cook top.
23. Reposition burner heads, burner caps, grates and knobs.
24. Connect power to appliance.

INSTALLATION INSTRUCTIONS

WHEN ALL HOOKUPS ARE COMPLETE

Make sure all controls are left in the off position.
Make sure the flow of combustion and ventilation
air to the cooktop is unobstructed.

CONVERTING TO LP GAS

(OR CONVERTING BACK TO NATURAL GAS FROM LP)

This cooktop leaves the factory set for use with natural gas. When converting to LP gas, the conversion must be performed by a qualified LP gas installer.

The conversion instructions and LP orifices are supplied with your cooktop.

Keep these instructions and the orifices in case you want to convert back to natural gas.

Memo



LG Electronics Inc.

Printed In Korea
Impreso en Korea
Imprimé en Corée