

This Owner's Manual is provided and hosted by [Appliance Factory Parts](http://Appliance Factory Parts).

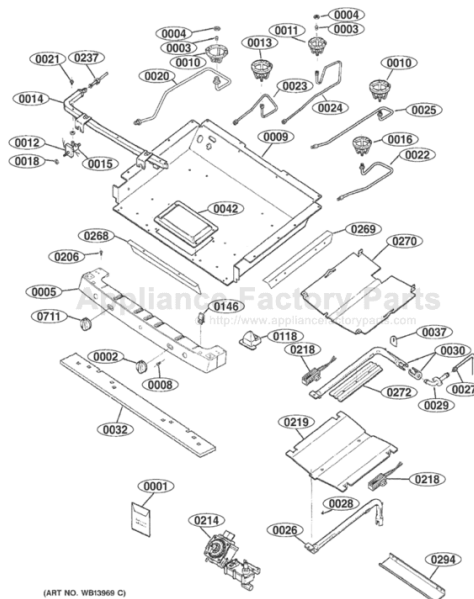

# LG LRG30355ST Owner's Manual

[Shop genuine replacement parts for LG LRG30355ST](#)



11/08

[Find Your LG Gas Range Parts - Select From 55 Models](#)

----- Manual continues below -----



## GAS RANGE

### USER'S GUIDE

Please read this guide thoroughly before operating and keep it handy for reference at all times.

## COCINA DE GAZ

### GUÍA PARA EL USO

Lea detenidamente estas instrucciones antes utilizar y guárdelas como referencia para el futuro.

## CUISINIÈRE À GAZ

### GUIDE D'UTILISATION

Veuillez lire le manuel d'utilisation avec soin avant l'utilisation et gardez-le en lieu sûr pour référence ultérieure.

Models/Modelos/Modèles

**LRG30855ST**  
**LRG30355ST**  
**LRG30355SW**  
**LRG30355SB**  
**LRG30357ST**  
**LRG30357SW**  
**LRG30357SB**

To contact LG Electronics, 24 hours a day, 7 days a week:

**1-800-243-0000 (USA)**

**1-888-542-2623 (CANADA)**

Or visit us on the Web at: ***us.lge.com (USA)***  
***ca.lge.com (CANADA)***

Para comunicarse con LG Electronics, 24 horas al día, 7 días a la semana:

**1-800-243-0000 (EE.UU.)**

**1-888-542-2623 (CANADÁ)**

O visítenos en la Web en: ***us.lge.com (EE.UU.)***  
***ca.lge.com (CANADÁ)***

Si vous désirez contacter LG Electronics, 24 heures sur 24, 7 jours sur 7 :

**1-800-243-0000 (USA)**

**1-888-542-2623 (CANADA)**

Ou visitez notre site Web : ***us.lge.com (USA)***  
***ca.lge.com (CANADA)***



# INTRODUCTION

## IMPORTANT SAFETY INFORMATION

What to Do if You Smell Gas . . . . .	3
Anti-Tip Device . . . . .	3
Basic Safety Precautions . . . . .	4-8

## OPERATING INSTRUCTIONS

Using the Surface Burners . . . . .	9, 10
Control Panel—Convection Models . . . . .	11
Control Panel—Non-Convection Models . . . . .	12
Using the Oven . . . . .	13-16
Using the Clock and Timer . . . . .	17
Using the Timed Baking and Roasting Features . . . . .	18, 19
Using the Probe (on convection models) . . . . .	19, 20
Using the Convection Oven (on some models) . . . . .	21-24
Using the Timed Convection Baking and Roasting Features (on some models) . . . . .	25, 26
Special Features of Your Oven Control . . . . .	26, 27
Using the Sabbath Feature . . . . .	28, 29
How to Adjust the Oven Thermostat . . . . .	30
Baking Tip . . . . .	30
Using the Electric Warming Drawer . . . . .	31, 32
Using the Self-Cleaning Oven . . . . .	33, 34

## CARE AND CLEANING

Care and Cleaning . . . . .	35
Burner Caps and Heads . . . . .	36
Burner Grates . . . . .	37
Cooktop Surface . . . . .	37
Stainless Steel Surfaces . . . . .	38
Oven Air Vents . . . . .	38
Control Panel . . . . .	38
Front Manifold Panel and Knobs . . . . .	38
Oven Door . . . . .	39
Oven Bottom . . . . .	39
Broiler Pan and Grid . . . . .	40
Oven Shelves and Drawer Racks . . . . .	40
Oven Light Replacement . . . . .	40
Removable Warming Drawer . . . . .	41

## TROUBLESHOOTING

Before Calling for Service . . . . .	42-45
--------------------------------------	-------

## WARRANTY

Product Registration Information . . . . .	47
--	----

## THANK YOU!

Congratulations on your purchase  
and welcome to the LG family.

Your new LG Gas Range  
combines precision cooking  
features with simple operation and  
stylish design. By following the  
operating and care instructions  
in this manual, your range will  
provide you with many years of  
reliable service.

# IMPORTANT SAFETY INFORMATION

## READ ALL INSTRUCTIONS BEFORE USE

**⚠ WARNING** For your safety, the information in this manual must be followed to minimize the risk of fire or explosion, electric shock, or to prevent property damage, personal injury, or death.

### ⚠ WARNING: ANTI-TIP DEVICE



- ALL RANGES CAN TIP
- INJURY TO PERSONS COULD RESULT
- INSTALL ANTI-TIP DEVICES PACKED WITH RANGE
- SEE INSTALLATION INSTRUCTIONS



**⚠ WARNING:** If the information in this manual is not followed exactly, a fire or explosion may result causing property damage, personal injury or death.

- Do not store or use gasoline or other flammable vapors and liquids in the vicinity of this or any other appliance.

## WHAT TO DO IF YOU SMELL GAS

- Do not try to light any appliance.
- Do not touch any electrical switch; do not use any phone in your building.
- Immediately call your gas supplier from a neighbor's phone. Follow the gas supplier's instructions.
- If you cannot reach your gas supplier, call the fire department.

Installation and service must be performed by a qualified installer, service agency or the gas supplier.

## ANTI-TIP DEVICE

**All ranges can tip and injury could result.**

To prevent accidental tipping of the range, attach it to the wall by installing the supplied Anti-Tip device.

To check if the device is installed and engaged properly, carefully tip the range forward. The Anti-Tip device should engage and prevent the range from tipping over.

If you pull the range out from the wall for any reason, make sure the device is properly

engaged when you push the range back against the wall. If it is not, there is a possible risk of the range tipping over and causing injury if you or a child stand, sit or lean on an open door.

Please refer to the Anti-Tip device information in this manual. Failure to take this precaution could result in tipping of the range and injury.

# IMPORTANT SAFETY INFORMATION

## READ ALL INSTRUCTIONS BEFORE USE

### IMPORTANT SAFETY NOTICE

The California Safe Drinking Water and Toxic Enforcement Act requires the Governor of California to publish a list of substances known to the state to cause birth defects or other reproductive harm, and requires businesses to warn customers of potential exposure to such substances.

Gas appliances can cause minor exposure to four of these substances, namely benzene, carbon monoxide, formaldehyde and soot, caused primarily by the incomplete combustion of natural gas or LP fuels. Properly adjusted burners, indicated by a bluish rather than a yellow flame, will minimize incomplete combustion. Exposure to these substances can be minimized by venting with an open window or using a ventilation fan or hood.

### SAFETY PRECAUTIONS

**Have the installer show you the location of the range gas shut-off valve and how to shut it off if necessary.**

- Have your range installed and properly grounded by a qualified installer, in accordance with the Installation Instructions. Any adjustment and service should be performed only by qualified gas range installers or service technicians.
- Do not attempt to repair or replace any part of your range unless it is specifically recommended in this manual. All other service should be referred to a qualified technician.
- Plug your range into a 120-volt grounded outlet only. Do not remove the round grounding prong from the plug. If in doubt about the grounding of the home electrical system, it is your personal responsibility and obligation to have an ungrounded outlet replaced with a properly grounded, three-prong outlet in accordance with the National Electrical Code. Do not use an extension cord with this appliance.
- Locate the range out of kitchen traffic path and out of drafty locations to prevent poor air circulation.
- Be sure all packaging materials are removed from the range before operating it to prevent fire or smoke damage should the packaging material ignite.
- Be sure your range is correctly adjusted by a qualified service technician or installer for the type of gas (natural or LP) that is to be used. Your range can be converted for use with either type of gas. See the Installation Instructions.

**WARNING:** These adjustments must be made by a qualified service technician in accordance with the manufacturer's instructions and all codes and requirements of the authority having jurisdiction. Failure to follow these instructions could result in serious injury or property damage. The qualified agency performing this work assumes responsibility for the conversion.

- After prolonged use of a range, high floor temperatures may result and many floor coverings will not withstand this kind of use. Never install the range over vinyl tile or linoleum that cannot withstand such type of use. Never install it directly over interior kitchen carpeting.
- Do not leave children alone or unattended where a range is hot or in operation. They could be seriously burned.
- Do not allow anyone to climb, stand or hang on the oven door, warming drawer, or cooktop. They could damage the range and even tip it over, causing severe personal injury.
- **CAUTION:** Items of interest to children should not be stored in cabinets above a range or on the backsplash of a range—children climbing on the range to reach items could be seriously injured.

# IMPORTANT SAFETY INFORMATION

## READ ALL INSTRUCTIONS BEFORE USE

### SAFETY PRECAUTIONS

**⚠ WARNING:** NEVER use this appliance as a space heater to heat or warm the room. Doing so may result in carbon monoxide poisoning and overheating of the oven.

- Never wear loose fitting or hanging garments while using the appliance. Be careful when reaching for items stored in cabinets over the range. Flammable material could be ignited if brought in contact with flame or hot oven surfaces and may cause severe burns.
- Do not store flammable materials in an oven, a warming drawer, or near a cooktop.
- Do not store or use combustible materials, gasoline or other flammable vapors and liquids in the vicinity of this or any other appliance.
- Do not let cooking grease or other flammable materials accumulate in or near the range.
- Do not use water on grease fires. Never pick up a flaming pan. Turn the controls off. Smother a flaming pan on a surface burner by covering the pan completely with a well-fitting lid, cookie sheet or flat tray. Use a multi-purpose dry chemical or foam-type fire extinguisher.

Flaming grease outside a pan can be put out by covering it with baking soda or, if available, by using a multi-purpose dry chemical or foam-type fire extinguisher.

Flame in the upper oven or lower oven drawer can be smothered completely by closing the oven door or drawer and turning the control to off or by using a multi-purpose dry chemical or foam-type fire extinguisher.

- Let the burner grates and other surfaces cool before touching them or leaving them where children can reach them.
- Never block the vents (air openings) of the range. They provide the air inlet and outlet that are necessary for the range to operate properly with correct combustion. Air openings are located at the rear of the cooktop, at the top and bottom of the oven door, and at the bottom of the range under the warming drawer, or kick panel.
- Large scratches or impacts to glass doors can lead to broken or shattered glass.

### SURFACE BURNERS

*Use proper pan size—avoid pans that are unstable or easily tipped. Select cookware having flat bottoms large enough to cover burner grates. To avoid spillovers, make sure cookware is large enough to contain the food properly. This will both save cleaning time and prevent hazardous accumulations of food, since heavy spattering or spillovers left on range can ignite. Use pans with handles that can be easily grasped and remain cool.*

- Always use the **LITE** position when igniting the top burners and make sure the burners have ignited.
- Never leave the surface burners unattended at high flame settings. Boilovers cause smoking and greasy spillovers that may catch on fire.
- Adjust the top burner flame size so it does not extend beyond the edge of the cookware. Excessive flame is hazardous.

# IMPORTANT SAFETY INFORMATION

## READ ALL INSTRUCTIONS BEFORE USE

### SURFACE BURNERS (continued)

- Use only dry pot holders—moist or damp pot holders on hot surfaces may result in burns from steam. Do not let pot holders come near open flames when lifting cookware. Do not use a towel or other bulky cloth in place of a pot holder.
- When using glass cookware, make sure it is designed for top-of-range cooking.
- To minimize the possibility of burns, ignition of flammable materials and spillage, turn cookware handles toward the side or back of the range without extending over adjacent burners.
- Carefully watch foods being fried at a high flame setting.
- Always heat fat slowly, and watch as it heats.
- Do not leave any items on the cooktop. The hot air from the vent may ignite flammable items and will increase pressure in closed containers, which may cause them to burst.
- If a combination of oils or fats will be used in frying, stir together before heating or as fats melt slowly.
- Use a deep fat thermometer whenever possible to prevent overheating fat beyond the smoking point.
- Use the least possible amount of fat for effective shallow or deep-fat frying. Filling the pan too full of fat can cause spillovers when food is added.
- Do not flame foods on the cooktop. If you do flame foods under the hood, turn the fan on.
- Do not use a wok on the cooking surface if the wok has a round metal ring that is placed over the burner grate to support the wok. This ring acts as a heat trap, which may damage the burner grate and burner head. Also, it may cause the burner to work improperly. This may cause a carbon monoxide level above that allowed by current standards, resulting in a health hazard.
- Foods for frying should be as dry as possible. Frost on frozen foods or moisture on fresh foods can cause hot fat to bubble up and over the sides of the pan.
- Never try to move a pan of hot fat, especially a deep fat fryer. Wait until the fat is cool.
- Do not leave plastic items on the cooktop—they may melt if left too close to the vent.
- Keep all plastics away from the surface burners.
- To avoid the possibility of a burn, always be certain that the controls for all burners are at the **OFF** position and all grates are cool before attempting to remove them.
- If range is located near a window, do not hang long curtains that could blow over the surface burners and create a fire hazard.
- If you smell gas, turn off the gas to the range and call a qualified service technician. Never use an open flame to locate a leak.
- Always turn the surface burner controls off before removing cookware.
- Do not lift the cooktop. Lifting the cooktop can lead to damage and improper operation of the range.

### COOK MEAT AND POULTRY THOROUGHLY

Cook meat and poultry thoroughly—meat to at least an INTERNAL temperature of 160°F and poultry to at least an INTERNAL temperature of 180°F. Cooking to these temperatures usually protects against foodborne illness.

# IMPORTANT SAFETY INFORMATION

## READ ALL INSTRUCTIONS BEFORE USE

### ELECTRIC WARMING DRAWER

- The purpose of the warming drawer is to hold hot cooked foods at serving temperature. Always start with hot food; cold food cannot be heated or cooked in the warming drawer.
- Do not use the drawer to dry newspapers. If overheated, they can catch on fire.
- Do not leave paper products, plastics, canned food, or combustible materials in the drawer.
- Never leave jars or cans of fat drippings in or near your drawer.
- Do not warm food in the drawer for more than two hours.
- **Do not touch the heating element or the interior surface of the drawer.** These surfaces may be hot enough to burn. **REMEMBER:** The inside surface of the drawer may be hot when the drawer is opened.
- Use care when opening the drawer. Open the drawer slightly and let hot air or steam escape before removing or replacing food. Hot air or steam which escapes can cause burns to hands, face and/or eyes.
- Do not use aluminum foil to line the warming drawer. Foil is an excellent heat insulator and will trap heat beneath it. This will upset the performance of the drawer and it could damage the interior finish.

### SELF-CLEANING OVEN

- Be sure to wipe off excess spillage before self-cleaning operation.
- Before self-cleaning the oven, remove the broiler pan, broiler grid, all cookware, probe and any aluminum foil.
- Nickel oven shelves should be removed from the oven before beginning the self-clean cycle.
- Clean only parts listed in this User's Guide.
- Do not clean the door gasket. The door gasket is essential for a good seal. Care should be taken not to rub, damage or move the gasket.
- If the self-cleaning mode malfunctions, turn the oven off and disconnect the power supply. Have it serviced by a qualified technician.
- Do not use oven cleaners. No commercial oven cleaner or oven liner of any kind should be used in or around any part of the oven. Residue from oven cleaners will damage the inside of the oven when the self-clean cycle is used.

# IMPORTANT SAFETY INFORMATION

## READ ALL INSTRUCTIONS BEFORE USE

### OVEN

Stand away from the range when opening the door of a hot oven. The hot air and steam that escape can cause burns to hands, face and eyes.

- Do not use the oven for a storage area. Items stored in the oven can ignite.
  - Keep the oven free from grease buildup.
  - Place the oven shelves in the desired position while the oven is cool.
  - Pulling out the shelf to the stop-lock is a convenience in lifting heavy foods. It is also a precaution against burns from touching hot surfaces of the door or oven walls. The lowest position is not designed to slide.
- ⚠ WARNING:** NEVER cover any slots, holes or passages in the oven bottom or cover an entire shelf with materials such as aluminum foil. Doing so blocks air flow through the oven and may cause carbon monoxide poisoning. Aluminum foil linings may also trap heat, causing a fire hazard.
- Do not heat unopened food containers. Pressure could build up and the container could burst, causing an injury.
  - Do not use aluminum foil anywhere in the oven except as described in this manual. Misuse could result in a fire hazard or damage to the range.
- When using cooking or roasting bags in the oven, follow the manufacturer's directions.
  - Do not use your oven to dry newspapers. If overheated, they can catch fire.
  - Use only glass cookware that is recommended for use in gas ovens.
  - Always remove the broiler pan from range as soon as you finish broiling. Grease left in the pan can catch fire if oven is used without removing the grease from the broiler pan.
  - When broiling, if meat is too close to the flame, the fat may ignite. Trim excess fat to prevent excessive flare-ups.
  - Make sure the broiler pan is in place correctly to reduce the possibility of grease fires.
  - If you should have a grease fire in the broiler pan, press the **CLEAR/OFF** pad, and keep the oven door closed to contain fire until it burns out.
  - For safety and proper cooking performance, always bake and broil with the oven door closed.

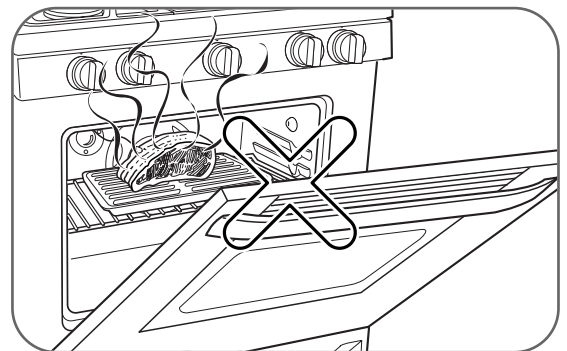

NOTE: Open door baking or broiling can cause damage to the knobs or valves.  
DO NOT LEAVE THE OVEN DOOR OPEN DURING COOKING OR COOL DOWN.

**READ AND FOLLOW THIS SAFETY INFORMATION CAREFULLY.  
SAVE THESE INSTRUCTIONS**

# OPERATING INSTRUCTIONS

## USING THE GAS SURFACE BURNERS

Throughout this manual, features and appearance may vary from your model.

### BEFORE LIGHTING A GAS BURNER

- Make sure all burners are in place.
- Make sure all grates on the range are properly placed before using any burner.

### AFTER LIGHTING A GAS BURNER

- Do not operate the burner for an extended period of time without cookware on the grate. The finish on the grate may chip without cookware to absorb the heat.

- Be sure the burners and grates are cool before you place your hand, a pot holder, cleaning cloths or other materials on them.

### IN CASE OF POWER FAILURE

In case of a power failure, you can light the gas surface burners on your range with a match. Hold a lit match to the burner, then push in and turn the control knob to the **LITE** position. Use extreme caution when lighting burners this way.

Surface burners in use when an electrical power failure occurs will continue to operate normally.

### HOW TO LIGHT A GAS SURFACE BURNER

- Make sure all the surface burners are placed in their respective positions.
- Push the control knob in and turn it to the **LITE** position.
- You will hear a little **clicking** noise—the sound of the electric spark igniting the burner.
- Turn the knob to adjust the flame size. If the knob stays at **LITE**, it will continue to click.
- When one burner is turned to **LITE**, all the burners spark. Do not attempt to disassemble or clean around any burner while another burner is on. An electric shock may result, which could cause you to knock over hot cookware.

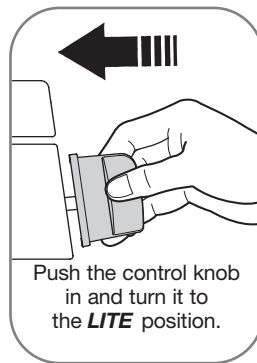

### SEALED GAS BURNERS

Your gas range cooktop has five sealed gas burners. They offer convenience, cleanability and flexibility to be used in a wide range of cooking applications.

The smallest burners are in the right rear and center positions. These burners can be turned down to **LO** for a very low simmer setting. They provide precise cooking performance for delicate foods such as sauces or foods that require low heat for a long cooking time.

The medium (left rear) and the large (left front) burners are the primary burners for most cooking. These general-purpose burners can be turned down from **HI** to **LO** to suit a wide range of cooking needs.

The extra large burner (right front) is the maximum output burner. Like the other four burners, it can be turned down from **HI** to **LO** for a wide range of cooking applications.

This burner is also designed to quickly bring large amounts of liquid to a boil. It has a special **SUPER BOIL™** setting designed to be used with cookware 10 inches or larger in diameter.

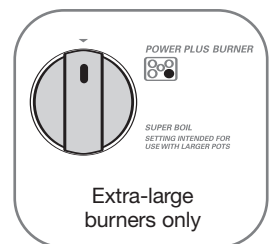
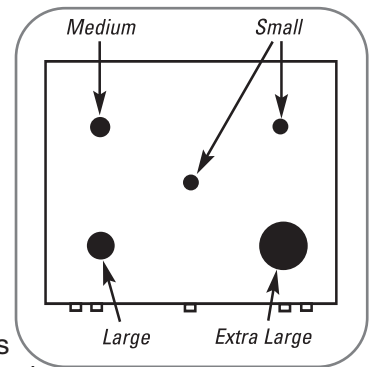

# OPERATING INSTRUCTIONS

## USING THE GAS SURFACE BURNERS

### HOW TO SELECT FLAME SIZE

For safe handling of cookware, never let the flames extend up the sides of the cookware.

Watch the flame, not the knob, as you reduce heat. When fast heating is desired, the flame size on a gas burner should match the cookware you are using.

Flames larger than the bottom of the cookware will not result in faster heating of the cookware and could be hazardous.

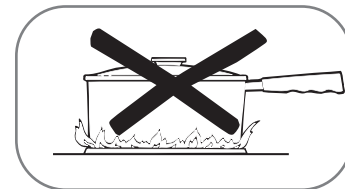

### TOP-OF-RANGE COOKWARE

**Aluminum:** Medium-weight cookware is recommended because it heats quickly and evenly. Most foods brown evenly in an aluminum skillet. Use saucepans with tight-fitting lids when cooking with minimum amounts of water.

**Cast-Iron:** If heated slowly, most skillets will give satisfactory results.

**Enamelware:** Under some conditions, the enamel of some cookware may melt. Follow cookware manufacturer's recommendations for cooking methods.

**Glass:** There are two types of glass cookware—those for oven use only and those for top-of-range cooking (saucepans, coffee and teapots). Glass conducts heat very slowly.

**Heatproof Glass Ceramic:** Can be used for either surface or oven cooking. It conducts heat very slowly and cools very slowly. Check cookware manufacturer's directions to be sure it can be used on gas ranges.

**Stainless Steel:** This metal alone has poor heating properties and is usually combined with copper, aluminum or other metals for improved heat distribution. Combination metal skillets usually work satisfactorily if they are used with medium heat as the manufacturer recommends.

### USING A WOK

We recommend that you use a 14-inch or smaller flat-bottomed wok.

Make sure the wok bottom sits flat on the grate. They are available at your local retail store.

Only a flat-bottomed wok should be used.

Do not use a wok support ring. Placing the ring over the burner or grate may cause the burner to work improperly, resulting in carbon monoxide levels above allowable standards.

*This can be hazardous to your health.*

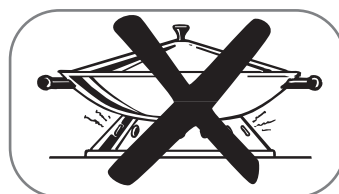
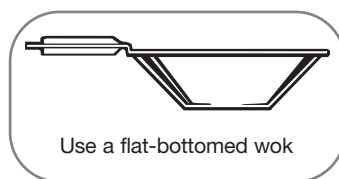

### STOVE-TOP GRILLS

Do not use stove top grills on your sealed gas burners. If you use the stove top grill on the sealed gas burner, it will cause incomplete combustion and can result in exposure to carbon monoxide levels above allowable current standards.

*This can be hazardous to your health.*



# OPERATING INSTRUCTIONS

## CONTROL PANEL—CONVECTION MODELS

Throughout this manual, features and appearance may vary from your model.

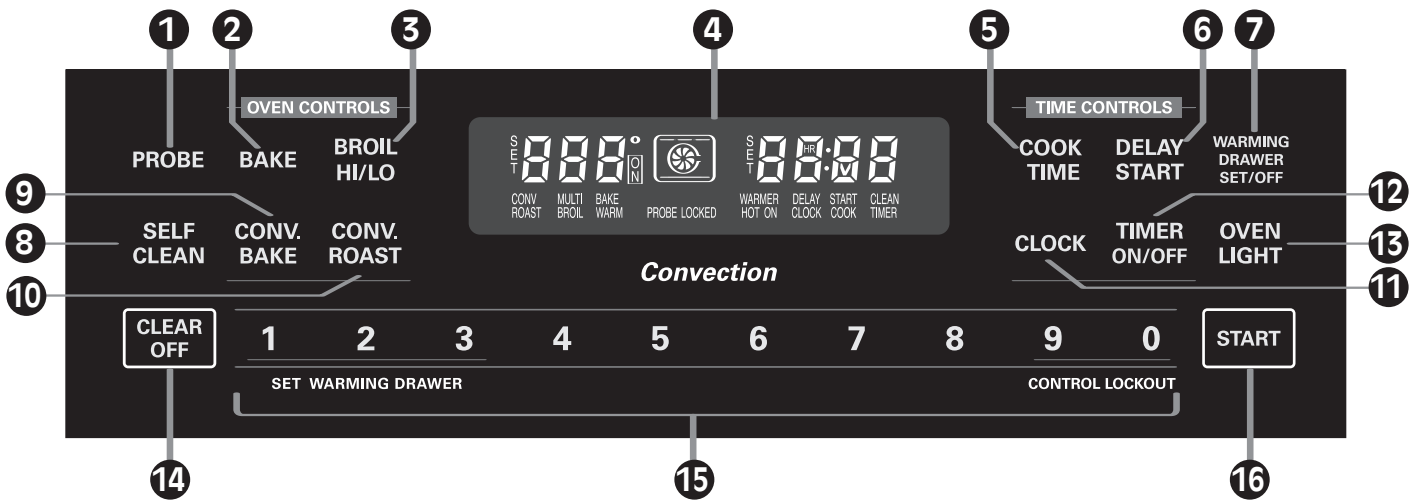

### OVEN CONTROL, CLOCK, AND TIMER FEATURES

- 1 PROBE PAD:** Touch this pad to select the probe function.
- 2 BAKE PAD:** Touch this pad to select the bake function.
- 3 BROIL HI/LO PAD:** Touch this pad to select the broil function.
- 4 DISPLAY:** Shows the time of day, oven temperature, whether the oven is in the bake, broil or self-cleaning mode and the times set for the timer or automatic oven operations. It will also show warming drawer settings.  
**NOTE:** If "F-" and a number or letter" flash in the display and the oven control signals, this indicates a function error code.  
If your oven was set for a timed oven operation and a power outage occurred, the clock and all programmed functions must be reset.  
The time of day will flash in the display when there has been a power outage. Reset the clock.  
If "Err" appears in the display, you have tried to set a time or temperature outside of the control's limits.  
Touch **CLEAR/OFF** pad and enter a new setting.  
Touch the **CLEAR/OFF** pad. Allow oven to cool for one hour. Put oven back into operation. If function error code repeats, disconnect power to range and call for service.
- 5 COOK TIME PAD:** Touch this pad and then touch the number pads to set the amount of time you want your food to cook. The oven will shut off when the cooking time has run out.
- 6 DELAY START PAD:** Use along with **COOK TIME** or **SELF CLEAN** pads to set the oven to start and stop automatically at a time you set.
- 7 WARMING DRAWER PAD:** Touch this pad and then touch number pads 1–3 to use the warming drawer. See the *Using the Electric Warming Drawer* section.
- 8 SELF CLEAN PAD:** Touch this pad to select self-cleaning function. See the *Using the Self-Cleaning Oven* section.
- 9 CONVECTION BAKE PAD:** Press to select baking with the convection function.
- 10 CONVECTION ROAST PAD:** Press to select roasting with the convection function.
- 11 CLOCK PAD:** Press before setting the time of day.
- 12 TIMER ON/OFF PAD:** Press to select the timer feature.
- 13 OVEN LIGHT PAD:** Touch this pad to turn the oven light on or off.
- 14 CLEAR/OFF PAD:** Touch this pad to cancel ALL oven operations except the clock, timer and warming drawer settings.
- 15 NUMBER PADS:** Use to set any function requiring numbers such as time of day on the clock, timer, oven temperature, internal food temperature, start time and length of operation for timed baking and self-cleaning.
- 16 START PAD:** Must be touched to start any cooking or cleaning function, and warming drawer settings.

# OPERATING INSTRUCTIONS

## CONTROL PANEL—NON-CONVECTION MODELS

Throughout this manual, features and appearance may vary from your model.

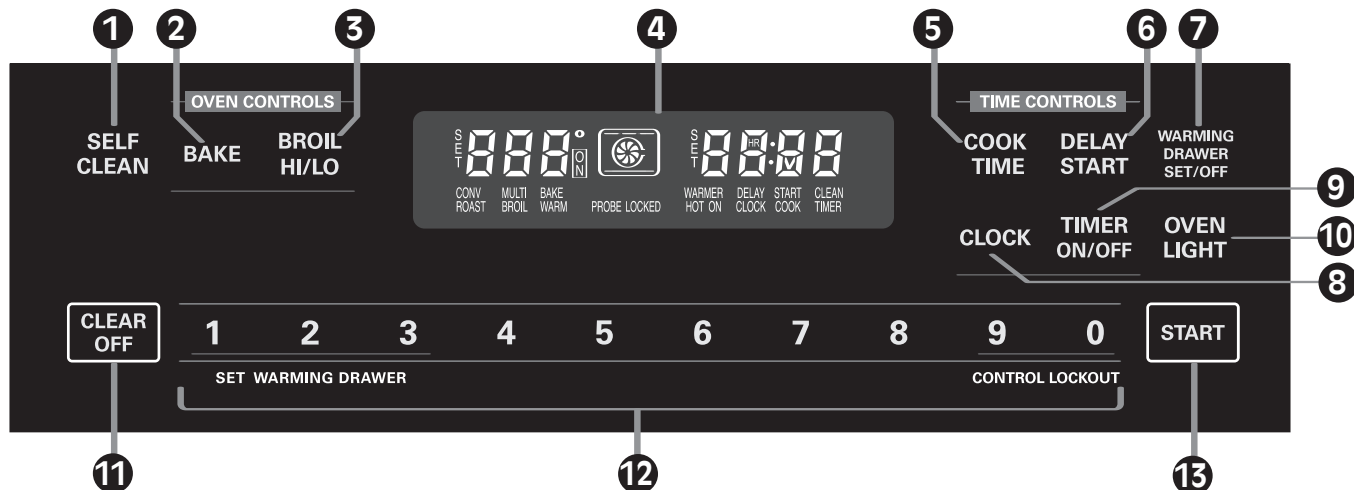

### OVEN CONTROL, CLOCK, AND TIMER FEATURES

- 1 SELF CLEAN PAD:** Touch this pad to select self-cleaning function. See the *Using the Self-Cleaning Oven* section.
- 2 BAKE PAD:** Touch this pad to select the bake function.
- 3 BROIL HI/LO PAD:** Touch this pad to select the broil function.
- 4 DISPLAY:** Shows the time of day, oven temperature, whether the oven is in the bake, broil or self-cleaning mode and the times set for the timer or automatic oven operations. It will also show warming drawer settings.  
**NOTE:** If “F- and a number or letter” flash in the display and the oven control signals, this indicates a function error code.  
If your oven was set for a timed oven operation and a power outage occurred, the clock and all programmed functions must be reset.  
The time of day will flash in the display when there has been a power outage. Reset the clock.  
If “Err” appears in the display, you have tried to set a time or temperature outside of the control’s limits.  
Touch **CLEAR/OFF** pad and enter a new setting.  
Touch the **CLEAR/OFF** pad. Allow oven to cool for one hour. Put oven back into operation. If function error code repeats, disconnect power to range and call for service.
- 5 COOK TIME PAD:** Touch this pad and then touch the number pads to set the amount of time you want your food to cook. The oven will shut off when the cooking time has run out.
- 6 DELAY START PAD:** Use along with **COOK TIME** or **SELF CLEAN** pads to set the oven to start and stop automatically at a time you set.
- 7 WARMING DRAWER PAD:** Touch this pad and then touch number pads 1–3 to use the warming drawer. See the *Using the Electric Warming Drawer* section.
- 8 CLOCK PAD:** Press before setting the time of day.
- 9 TIMER ON/OFF PAD:** Press to select the timer feature.
- 10 OVEN LIGHT PAD:** Touch this pad to turn the oven light on or off.
- 11 CLEAR/OFF PAD:** Touch this pad to cancel ALL oven operations except the clock, timer and warming drawer settings.
- 12 NUMBER PADS:** Use to set any function requiring numbers such as time of day on the clock, timer, oven temperature, internal food temperature, start time and length of operation for timed baking and self-cleaning.
- 13 START PAD:** Must be touched to start any cooking or cleaning function, and warming drawer settings.

# OPERATING INSTRUCTIONS

## USING THE OVEN

### BEFORE YOU BEGIN

The shelves have stop-locks, so that when placed correctly on the shelf supports (A through E), they will stop before coming completely out, and will not tilt.

When placing and removing cookware, pull the shelf out to the bump on the shelf support.

**To remove a shelf,** pull it toward you, tilt the front end up and pull it out.

**To replace,** place the end of the shelf (stop-locks) on the support, tilt up the front and push the shelf in.

**NOTE:** The shelf is not designed to slide out at the special low shelf (R) position.

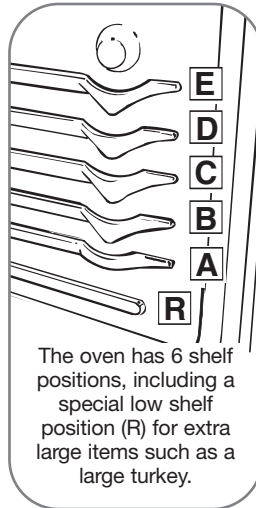

### OVEN VENT

Your oven is vented through ducts at the rear of the range. Do not block these ducts when cooking in the oven—it is important that the flow of hot air from the oven and fresh air to the oven burner be uninterrupted. Avoid touching the vent openings or nearby surfaces during oven or broiler operation—they may become hot.

- *Handles of pots and pans on the cooktop may become hot if left too close to the vent.*
- *Do not leave plastic or flammable items on the cooktop—they may melt or ignite if left too close to the vent.*
- *Do not leave closed containers on the cooktop. The pressure in closed containers may increase, which may cause them to burst.*
- *Metal items will become very hot if they are left on the cooktop, and could cause burns.*

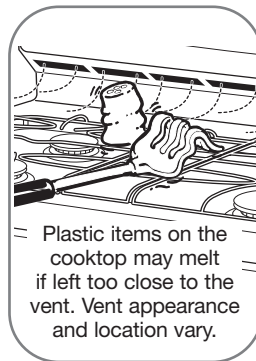

### POWER OUTAGE

**CAUTION:** Do not make any attempt to operate the electric ignition oven during an electrical power failure.

The oven or broiler cannot be lit during a power failure. Gas will not flow unless the glow bar is hot.

If the oven is in use when a power failure occurs, the oven burner shuts off and cannot be re-lit until power is restored. This is because the flow of gas is automatically stopped and will not resume when power is restored until the glow bar has reached operating temperature.

### OVEN LIGHT

**OVEN LIGHT** Touch the **OVEN LIGHT** pad on the control panel to turn the light on or off.

# OPERATING INSTRUCTIONS

## USING THE OVEN

To avoid possible burns, place the shelves in the desired position before you turn the oven on.

### HOW TO SET THE OVEN FOR BAKING OR ROASTING

Your oven is not designed for open-door cooking.

- BAKE** 1 Touch the **BAKE** pad.
- 1 2 3 2 Touch the **number** pads to set the desired temperature.
- START** 3 Touch the **START** pad.

The word **ON** and **100°** will be displayed. As the oven heats up, the display will show the changing temperature. When the oven reaches the temperature you set, a tone will sound.

To change the oven temperature during **BAKE** cycle, press the **BAKE** pad and then the number pads to get the new temperature.

- 4 Check food for doneness at minimum time on recipe. Cook longer if necessary.
- CLEAR OFF** 5 Touch the **CLEAR/OFF** pad when cooking is complete.

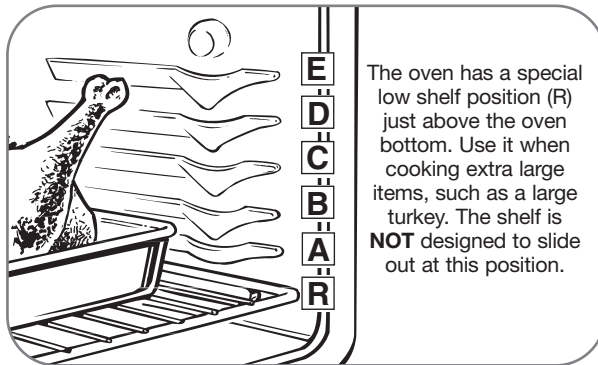

### OVEN MOISTURE

As your oven heats up, the temperature change of the air in the oven may cause water droplets to form on the door glass. These droplets are harmless and will evaporate as the oven continues to heat up.

### PREHEATING AND PAN PLACEMENT

Preheat the oven if the recipe calls for it. To preheat, set the oven at the correct temperature. Preheating is necessary when convection baking and for good results when baking cakes, cookies, pastry and breads.

Baking results will be better if baking pans are centered in the oven as much as possible. Pans should not touch each other or the walls of the oven. If you need to use two shelves, stagger the pans so one is not directly above the other, and leave approximately 1½" between pans, from the front, back and sides of the wall.

Type of Food	Shelf Position
Frozen pies (on cookie sheet)	B or C
Angel food cake, bundt or pound cakes	A
Biscuits, muffins, brownies, cookies, cupcakes, layer cakes, pies	C
Casseroles	B or C
Roasting	R or A

### ALUMINUM FOIL

**Never cover the oven bottom with aluminum foil.**

You can use aluminum foil to line the broiler pan and broiler grid.

However, you must mold the foil tightly to the grid and cut slits in it just like the grid.

Aluminum foil may also be used to catch a spillover. To do so, place a small sheet of foil on a lower shelf several inches below the food.

Never entirely cover a shelf with aluminum foil. This will disturb the heat circulation and result in poor baking.



# OPERATING INSTRUCTIONS

## USING THE OVEN

### HOW TO SET THE OVEN FOR BROILING

Your oven is not designed for open-door cooking.

- 1 Place the meat or fish on the broiler grid in the broiler pan.
- 2 Follow suggested shelf positions in the *Broiling Guide*.
- 3 The oven door **must** be closed during broiling.

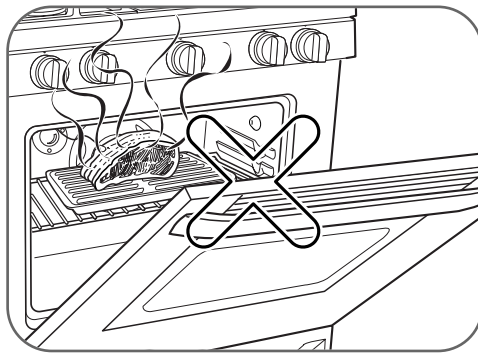

NOTE: Open door baking or broiling can cause damage to the knobs or valves. DO NOT LEAVE THE OVEN DOOR OPEN DURING COOKING OR COOL DOWN.

Serve the food immediately, and leave the pan outside the oven to cool during the meal for easiest cleaning.

Use **LO Broil** to cook foods such as poultry or thick cuts of meat thoroughly without over-browning them.

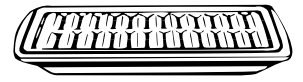

Always use the broiler pan and grid that came with your oven.

It is designed to minimize smoking and spattering by trapping juices in the shielded lower part of the pan.

BROIL  
HI/LO

- 4 Touch the **BROIL HI/LO** pad once for **HI Broil**. To change to **LO Broil**, touch the **BROIL HI/LO** pad again.

START

- 5 Touch the **START** pad.

CLEAR  
OFF

- 6 When broiling is finished, touch the **CLEAR/OFF** pad.

# OPERATING INSTRUCTIONS

## USING THE OVEN

### BROILING GUIDE

The size, weight, thickness, starting temperature and your preference of doneness will affect broiling times. This guide is based on meats at refrigerator temperature.

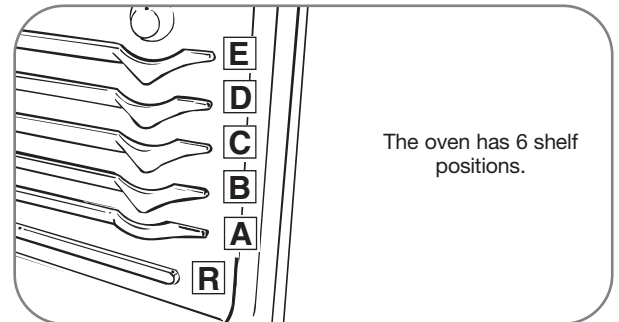

Food	Quantity and/or Thickness	Shelf* Position	First Side Time (min.)	Second Side Time (min.)	Comments
<b>Bacon</b>	1/2 lb. (about 8 thin slices)	C	4	3	Arrange in single layer.
<b>Ground Beef</b> Well Done	1 lb. (4 patties) 1/2 to 3/4" thick	C	10	7-10	Space evenly. Up to 8 patties take about the same time.
<b>Beef Steaks</b> Rare Medium Well Done	1" thick 1 to 1 1/2 lbs.	C C C	9 12 13	7 5-6 8-9	Steaks less than 1" thick cook through before browning. Pan frying is recommended. Remove fat.
Rare Medium Well Done	1 1/2" thick 2 to 2 1/2 lbs.	C C C	10 12-15 25	6-7 10-12 16-18	
<b>Chicken</b>	1 whole 2 to 2 1/2 lbs., split lengthwise 4 bone-in breasts	B B	30-35 25-30	15-20 10-15	Brush each side with melted butter. Broil skin-side-down first.
<b>Lobster Tails</b>	2-4 6 to 8 oz. each	C	13-16	Do not turn over.	Cut through back of shell. Spread open. Brush with melted butter before broiling and after half of broiling time.
<b>Fish Fillets</b>	1/4 to 1/2" thick	D	6	6	Handle and turn very carefully. Brush with lemon butter before and during cooking, if desired. Preheat broiler to increase browning.
<b>Ham Slices</b> (precooked)	1" thick 1/2" thick	C D	8 6	8 6	Increase time 5 to 10 minutes per side for 1 1/2" thick or home-cured ham.
<b>Pork Chops</b> Well Done	2 (1/2" thick) 2 (1" thick) about 1 lb.	D D	10 15	8 8	Remove fat.
<b>Lamb Chops</b> Medium Well Done	2 (1" thick) about 10 to 12 oz.	D D	6 10	4-7 10	Remove fat.
Medium Well Done	2 (1 1/2" thick) about 1 lb.	D D	10 17	4-6 12-14	



† The U.S. Department of Agriculture says "Rare beef is popular, but you should know that cooking it to only 140°F. means some food poisoning organisms may survive." (Source: *Safe Food Book, Your Kitchen Guide*, USDA Rev. June 1985.)

\* See illustration for description of shelf positions.

## USING THE CLOCK AND TIMER

### HOW TO SET THE CLOCK



The clock must be set to the correct time of day for the automatic oven timing functions to work properly. The time of day cannot be changed during a timed baking or self-cleaning cycle.

-  **1** Touch the **CLOCK** pad once to set.
-  **2** Touch the **number** pads to enter the time. Touch the number pads the same way you read them. For example, to set 12:34, touch the number pads **1**, **2**, **3**, and **4** in that order.  
If number pads are not touched within one minute after you touch the **CLOCK** pad, the display reverts to the original setting. If this happens, touch the **CLOCK** pad and reenter the time of day.
-  **3** Touch the **START** pad until the time of day shows in the display. This enters the time and starts the clock.

To check the time of day when the display is showing other information, simply touch the **CLOCK** pad.

### HOW TO SET THE TIMER

The timer does not control oven operations. The maximum setting on the timer is 9 hours and 59 minutes.

-  **1** Touch the **TIMER ON/OFF** pad.
-  **2** Touch the **number** pads until the amount of time you want shows in the display. The maximum time that can be entered in minutes is 59. Times more than 59 minutes should be changed to hours and minutes. For example, to enter 90 minutes as 1 hour 30 minutes, touch **1**, **3**, and **0** in that order.

**NOTE:** If you make a mistake, press the **TIMER ON/OFF** pad and begin again.



- 3** Touch the **START** pad. After pressing the **START** pad, **SET** disappears; this tells you the time is counting down, although the display does not change until one minute has passed.



- 4** When the timer reaches **:00**, the control will beep 3 times followed by one beep every 6 seconds until the **TIMER ON/OFF** pad is touched.

The 6 second tone can be canceled by following the steps in the *Special Features of Your Oven Control* section under *Tones at the End of a Timed Cycle*.

**NOTE:** The timer is a minute timer only. The **CLEAR/OFF** pad does not affect the timer.

### HOW TO RESET THE TIMER

If the display is still showing the time remaining, you may change it by touching the **TIMER ON/OFF** pad, then touch the number pads until the time you want appears in the display.

If the remaining time is not in the display (clock, delay start or cooking time are in the display), recall the remaining time by touching the **TIMER ON/OFF** pad and then touching the number pads to enter the new time you want.

### HOW TO CANCEL THE TIMER

Touch the **TIMER ON/OFF** pad twice.

### POWER OUTAGE

If a flashing time is in the display, you have experienced a power failure. Reset the clock.

Touch the **CLOCK** pad once to reset. Enter the correct time of day by touching the appropriate number pads. Touch the **START** pad.





# OPERATING INSTRUCTIONS

## USING THE TIMED BAKING & ROASTING FEATURES

**NOTE:** Foods that spoil easily—such as milk, eggs, fish, stuffings, poultry and pork—should not be allowed to sit for more than 1 hour before or after cooking. Room temperature promotes the growth of harmful bacteria. Be sure that the oven light is off because heat from the bulb will speed harmful bacteria growth.

### HOW TO SET AN IMMEDIATE START AND AUTOMATIC STOP

The oven will turn on immediately and cook for a selected length of time. At the end of the cooking time, the oven will turn off automatically.

-  Touch the **BAKE** pad.
-  Touch the **number** pads to set the desired oven temperature.
-  Touch the **COOK TIME** pad.  
**NOTE:** If your recipe requires preheating, you may need to add additional time to the length of the cooking time.
-  Touch the **number** pads to set the desired length of cooking time. The minimum cooking time you can set is 1 minute. The entered oven temperature and the cooking time will be shown in the display.
-  Touch the **START** pad.

The oven will turn **ON**, and the display will show the cooking time countdown and the changing temperature starting at 100°F. (The temperature display will start to change once the oven temperature reaches 100°F.) When the oven reaches the temperature you set, 3 beeps will sound.

The oven will continue to cook for the set amount of time, then turn off automatically, unless the **Cook and Hold** feature was set. See the *Special Features of Your Oven Control* section.







After the oven turns off, the end-of-cycle tone will sound.

-  Touch the **CLEAR/OFF** pad to clear the display if necessary. Remove the food from the oven. Remember, even though the oven turns off automatically, food left in the oven will continue cooking after the oven turns off.

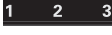
### HOW TO SET A DELAYED START AND AUTOMATIC STOP

The oven will turn on at the time of day you set, cook for a specific length of time and then turn off automatically.

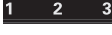
Make sure the clock shows the correct time of day.

-  Touch the **BAKE** pad.
-  Touch the **number** pads to set the desired oven temperature.
-  Touch the **COOK TIME** pad.  
**NOTE:** If your recipe requires preheating, you may need to add additional time to the length of the cooking time.
-  Touch the **number** pads to set the desired length of cooking time. The minimum cooking time you can set is 1 minute. The entered oven temperature and the cooking time will be shown in the display.
-  Touch the **DELAY START** pad.
-  Touch the **number** pads to set the time of day you want the oven to turn on and start cooking.
-  Touch the **START** pad.

**NOTE:** An attention tone will sound if you are using timed baking and do not touch the **START** pad.

**NOTE:** If you would like to check the times you have set, touch the **DELAY START** pad to check the start time you have set or touch the **COOK TIME** pad to check the length of cooking time you have set.

The oven will turn **ON**, and the display will show the cooking time countdown and the changing temperature starting at 100°F. (The temperature display will start to change once the oven temperature reaches 100°F.) When the oven reaches the temperature you set, 3 beeps will sound.

(continued on next page)

# OPERATING INSTRUCTIONS

## USING THE TIMED BAKING & ROASTING FEATURES

### HOW TO SET A DELAYED START AND AUTOMATIC STOP (CONTINUED)

The oven will continue to cook for the set amount of time, then turn off automatically, unless the **Cook and Hold** feature was set. See the *Special Features of Your Oven Control* section.

After the oven turns off, the end-of-cycle tone will sound.



- 8 Touch the **CLEAR/OFF** pad to clear the display if necessary. Remove the food from the oven. Remember, even though the oven turns off automatically, food left in the oven will continue cooking after the oven turns off.

## USING THE PROBE (on convection models)

For many foods, especially roasts and poultry, internal food temperature is the best test for doneness. The temperature probe takes the guesswork out of cooking foods to the exact doneness you want.

Use of probes other than the one provided with this product may result in damage to the probe.

Use the handles of the probe and plug when inserting and removing them from the food and outlet.

- To avoid damaging your probe, do not use tongs to pull on the cable when removing it.
- To avoid breaking the probe, make sure food is completely defrosted before inserting.
- To prevent possible burns, do not unplug the probe from the outlet until the oven has cooled.
- Never leave your probe inside the oven during a self-cleaning cycle.
- Do not store the probe in the oven.

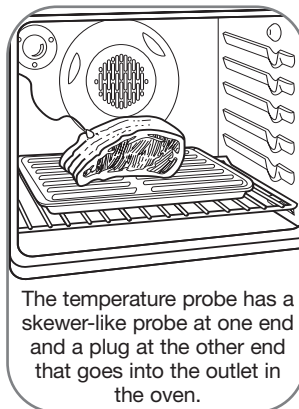

The temperature probe has a skewer-like probe at one end and a plug at the other end that goes into the outlet in the oven.

After preparing the meat and placing it on a trivet or on the broiler pan grid, follow these directions for proper probe placement.

Insert the probe completely into the meat. It should not touch the bone, fat or gristle.

For roasts with no bone, insert the probe into the meatiest part of the roast. For bone-in ham or lamb, insert the probe into the center of the lowest large muscle.

Insert the probe into the center of dishes such as meat loaf or casseroles.

Insert the probe into the meatiest part of the inner thigh from below and parallel to the leg of a whole turkey.

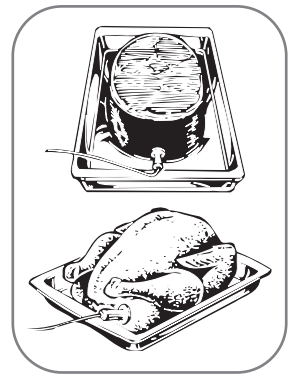

*(continued on next page)*

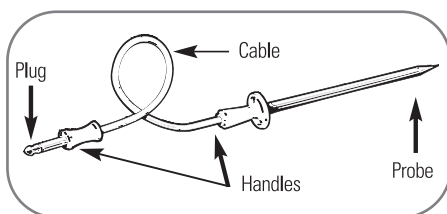

# OPERATING INSTRUCTIONS

## USING THE PROBE (on convection models)

### HOW TO SET THE OVEN FOR COOKING WHEN USING THE PROBE

- 1 Insert the probe into the food.
- 2 Plug the probe into the outlet in the oven. Make sure it's pushed all the way in. Close the oven door.



- 3 Touch the **PROBE** pad.



- 4 Touch the **number** pads to set the desired internal food or meat temperature between 100°F and 200°F.



- 5 Touch the **BAKE** pad.

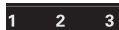

- 6 Touch the **number** pads to set the desired oven temperature.



- 7 Touch the **START** pad.



- 8 When the internal temperature of the food reaches the number you have set, the probe and the oven turn off and the oven control signals. To stop the signal, touch the **CLEAR/OFF** pad. Use hot pads to remove the probe from the food. Do not use tongs to pull on it—they might damage it.

To change the oven temperature during probe cooking, touch the **BAKE** pad and then the number pads to set the new temperature.

- If the probe is removed from the food before the final temperature is reached, a tone will sound and the display will flash until the probe is removed from the oven.
- You can use the timer even though you cannot use timed oven operations while using the probe.

# OPERATING INSTRUCTIONS

## USING THE CONVECTION OVEN (on some models)

The convection oven fan shuts off when the oven door is opened. **DO NOT** leave the door open for long periods of time while using convection cooking.

To help you understand the difference between convection bake and roast and traditional bake and roast, here are some general guidelines.

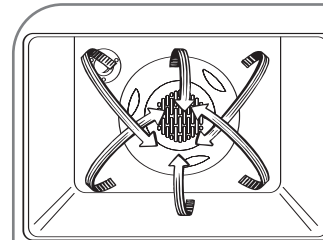

In a convection oven, a fan circulates hot air over, under and around the food. This circulating hot air is evenly distributed throughout the oven cavity. As a result, foods are evenly cooked and browned—often in less time than with regular heat.

### CONVECTION BAKE

- Preheat the oven. See the *Using the Oven—Preheating and Pan Placement* section.
- Ideal for foods cooked on multiple shelves.
- Good for large quantities of baked foods.

- Good results with cookies, biscuits, brownies, cupcakes, cream puffs, sweet rolls, angel food cake and bread.

The convection fan circulates the heated air evenly over and around the food.

### CONVECTION ROAST

- Good for large tender cuts of meat, uncovered.

The convection fan circulates the heated air evenly over and around the food.

Using the grid and broiler pan provided, heated air will be circulated over and around the food being

roasted. The heated air seals in juices quickly for a moist and tender product while, at the same time, creating a rich golden brown exterior.

Roasts or poultry should be cooked on shelf position (A).

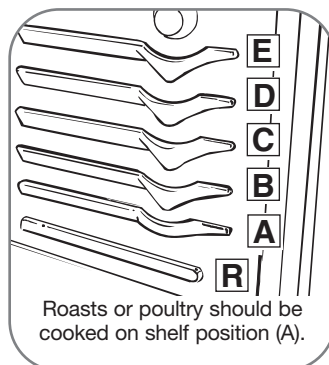

When you are convection roasting, it is important that you use the broiler pan and grid for best convection roasting results. The pan is used to catch grease spills and the grid is used to prevent grease splatters.

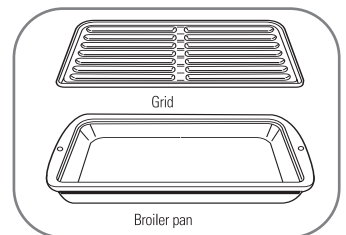

- Place the shelf in shelf position (A).
- Place the grid on the broiler pan.



# OPERATING INSTRUCTIONS

## USING THE CONVECTION OVEN (on some models)

### AUTOMATIC RECIPE CONVERSION

You can use your favorite recipes in the convection oven.

When using **CONVECTION BAKE**, the **CONVECTION AUTO CONVERSION** feature will automatically convert the temperature from regular baking to **CONVECTION BAKE** temperatures. This feature will display the actual converted (reduced) temperature.

-  1 Select **CONVECT BAKE**.
-  2 Using the number pad, enter the temperature recommended in the recipe. The display will show the temperature you entered from your recipe.
-  3 Touch the **START** pad.

**CON** will appear in the display and then show the converted temperature. After the preheat is complete, the display will show the converted oven temperature.



### COOKWARE FOR CONVECTION COOKING

Before using your convection oven, check to see if your cookware leaves room for air circulation in the oven. If you are baking with several pans, leave space between them. Also, be sure the pans do not touch each other or the walls of the oven.

#### Paper and Plastic

Heat-resistant paper and plastic containers that are recommended for use in regular ovens can be used in convection ovens. Plastic cookware that is heat-resistant to temperatures of 400°F can also be used, when oven is below 400°F.

### HOW TO SET THE OVEN FOR CONVECTION BAKING OR ROASTING

-  1 Touch the **CONVECTION BAKE** or **CONVECTION ROAST** pad.
-  2 Touch the **number** pads to set the desired oven temperature.
-  3 Touch the **START** pad.

To change the oven temperature, touch the **CONVECTION BAKE** or **CONVECTION ROAST**, pad and then the number to set the new temperature.



Touch the **CLEAR/OFF** pad when baking is finished.

- Use pan size recommended in the recipe.
- Some package instructions for frozen casseroles, main dishes or baked goods have been developed using commercial convection ovens. For best results in this oven, preheat the oven and use the temperature, for regular baking, on the package.

#### NOTE:

- If a food manufacturer gives specific convection baking package instructions, program the **AUTO CONVERSION** temperature so that the preheated oven temperature reads the same as the temperature on the package instructions.

### Metal and Glass

Any type of cookware will work in your convection oven. However, metal pans heat the fastest and are recommended for convection baking.

- Darkened or matte-finished pans will bake faster than shiny pans.
- Glass or ceramic pans cook more slowly.

When baking cookies, you will get the best results if you use a flat cookie sheet instead of a pan with low sides.

For recipes like oven-baked chicken, use a pan with low sides. Hot air cannot circulate well around food in a pan with high sides.

When the oven starts to heat, the changing temperature, starting at 100°F, will be displayed. When the oven reaches the temperature you set, 3 beeps will sound.



- 4 Touch the **CLEAR/OFF** pad when finished.

#### NOTE:

- You will hear a fan while cooking with convection. The fan will stop when the door is opened, but the heat will not turn off.
- The fan will not start until the preheat temperature is reached.

# OPERATING INSTRUCTIONS

## USING THE CONVECTION OVEN (on some models)

### MULTI-SHELF BAKING

Because heated air is circulated evenly throughout the oven, foods can be baked with excellent results using multiple shelves.

Multi-shelf baking may increase cook times slightly for some foods but the overall result is time saved. Cookies, muffins, biscuits and other quick breads give very good results with multi-shelf baking.

When baking larger foods on 3 shelves, place one shelf in the 2nd (A) position, one on the 4th (C) position and the third shelf in the 6th (E) position.

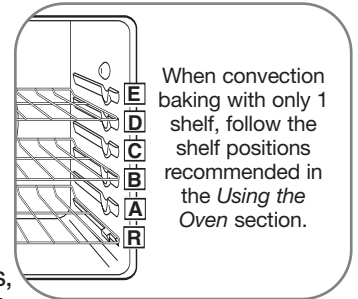

When baking cookies, place the shelves in the 4th (C), 5th (D), and 6th (E) positions.

### HOW TO SET THE OVEN FOR CONVECTION ROASTING WHEN USING THE PROBE (on convection models)

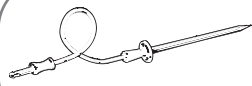

For best results when roasting large turkeys and roasts, we recommend using the probe included with the convection oven.

The display will flash **PROBE** and the oven control will signal if the probe is inserted into the outlet, and you have not set a probe temperature and touched the **START** pad.

- 1 Place the shelf in the shelf position (A). Insert the probe completely into the food.
- 2 Plug the probe into the outlet in the oven. Make sure it is pushed all the way in. Close the oven door.
- 3 Touch the **CONVECTION ROAST** pad.
- 4 Touch the **number** pads to set the desired oven temperature.
- 5 Touch the **PROBE** pad.

CONV.  
ROAST

1 2 3

PROBE

1 2 3

- 6 Touch the **number** pads to set the desired internal food temperature.

To change the oven temperature during the Convection Roast cycle, touch the **CONVECTION ROAST** pad and then touch the number pads to set the new desired temperature.

START

- 7 Touch the **START** pad.

When the oven starts to heat, the word **LO** will be in the display.

After the internal temperature of the food reaches 100°F, the changing internal temperature will be shown in the display.

START

- 8 When the internal temperature of the food reaches the number you have set, the probe and the oven turn off and the oven control signals. To stop the signal, touch the **CLEAR/OFF** pad. Use hot pads to remove the probe from the food. Do not use tongs to pull on it—they might damage it.

**CAUTION:** To prevent possible burns, do not unplug the probe from the oven outlet until the oven has cooled. Do not store the probe in the oven.

#### NOTE:

- If the probe is removed from the food before the final temperature is reached, a tone will sound and the display will flash until the probe is removed from the oven.
- You will hear a fan while cooking with this feature. The fan will stop when the door is opened, but the heat will not turn off.
- You can use the timer even though you cannot use timed oven operations while using the probe.



# OPERATING INSTRUCTIONS

## USING THE CONVECTION OVEN (on some models)

### CONVECTION ROASTING CHART

Meats		Minutes/Lb.	Oven Temp.	Internal Temp.	
<b>Beef</b>	Rib (3 to 5 lbs.)	Rare †	20–24	325°F	140°F
		Medium	24–28	325°F	160°F
		Well	28–32	325°F	170°F
	Boneless Rib, Top Sirloin	Rare †	20–24	325°F	140°F
Medium		24–28	325°F	160°F	
Well		28–32	325°F	170°F	
Beef Tenderloin	Rare †	10–14	325°F	140°F	
	Medium	14–18	325°F	160°F	
	Pot Roast (2½ to 3 lbs.) chuck, rump	35–45	300°F	170°F	
<b>Pork</b>	Bone-in (3 to 5 lbs.)	23–27	325°F	170°F	
	Boneless (3 to 5 lbs.)	23–27	325°F	170°F	
	Pork Chops (½ to 1" thick)	2 chops	30–35 total	325°F	170°F
		4 chops	35–40 total	325°F	170°F
6 chops		40–45 total	325°F	170°F	
<b>Ham</b>	Canned (3 lbs. fully cooked)	14–18	325°F	140°F	
	Butt (5 lbs. fully cooked)	14–18	325°F	140°F	
	Shank (5 lbs. fully cooked)	14–18	325°F	140°F	
<b>Lamb</b>	Bone-in (3 to 5 lbs.)	Medium	17–20	325°F	160°F
		Well	20–24	325°F	170°F
	Boneless (3 to 5 lbs.)	Medium	17–20	325°F	160°F
		Well	20–24	325°F	170°F
<b>Seafood</b>	Fish, whole (3 to 5 lbs.)	30–40 total	400°F		
	Lobster Tails (6 to 8 oz. each)	20–25 total	350°F		
<b>Poultry</b>	Whole Chicken (2½ to 3½ lbs.)	24–26	350°F	180–185°F	
	Cornish Hens Unstuffed (1 to 1½ lbs.)	50–55 total	350°F	180–185°F	
		55–60 total	350°F	180–185°F	
	Duckling (4 to 5 lbs.)	24–26	325°F	180–185°F	
	Turkey, whole*	Unstuffed (10 to 16 lbs.)	8–11	325°F	180–185°F
		Unstuffed (18 to 24 lbs.)	7–10	325°F	180–185°F
	Turkey Breast (4 to 6 lbs.)	16–19	325°F	170°F	

\* Stuffed birds generally require 30–45 minutes additional roasting time. Shield legs and breast with foil to prevent overbrowning and drying of skin.

† The U.S. Department of Agriculture says "Rare beef is popular, but you should know that cooking it to only 140°F. means some food poisoning organisms may survive." (Source: *Safe Food Book, Your Kitchen Guide*, USDA Rev. June 1985.)

# OPERATING INSTRUCTIONS

## USING THE TIMED CONVECTION BAKING AND ROASTING FEATURES (on some models)

You will hear a fan while cooking with this feature. The fan will stop when the door is opened, but the heat will not turn off.

**NOTE:** Foods that spoil easily—such as milk, eggs, fish, stuffings, poultry and pork—should

not be allowed to sit for more than 1 hour before or after cooking. Room temperature promotes the growth of harmful bacteria. Be sure that the oven light is off because heat from the bulb will speed harmful bacteria growth.

### HOW TO SET AN IMMEDIATE START AND AUTOMATIC STOP

The oven will turn on immediately and cook for a selected length of time. At the end of the cooking time, the oven will turn off automatically.

 1 Touch the **CONVECTION BAKE** pad.

 2 Touch the **number** pads to set the desired oven temperature.

 3 Touch the **COOK TIME** pad.

**NOTE:** If your recipe requires preheating, you may need to add additional time to the length of the cooking time.

 4 Touch the **number** pads to set the desired length of cooking time. The minimum cooking time you can set is 1 minute.  
The oven temperature that you set and the cooking time that you entered will be in the display.

 5 Touch the **START** pad.

The oven will turn **ON**, and the display will show the cooking time countdown and the changing temperature starting at 100°F. (The temperature display will start to change once the oven temperature reaches 100°F.) When the oven reaches the temperature you set, 3 beeps will sound.

The oven will continue to cook for the set amount of time, then turn off automatically, unless the **Cook and Hold** feature was set. See the *Special Features of Your Oven Control* section.

After the oven turns off, the end-of-cycle tone will sound.

 6 Touch the **CLEAR/OFF** pad to clear the display if necessary. Remove the food from the oven. Remember, even though the oven turns off automatically, food left in the oven will continue cooking after the oven turns off.

### HOW TO SET A DELAYED START AND AUTOMATIC STOP

The oven will turn on at the time of day you set, cook for a specific length of time and then turn off automatically.

Make sure the clock shows the correct time of day.

 1 Touch the **CONVECTION BAKE** pad.

 2 Touch the **number** pads to set the desired oven temperature.

 3 Touch the **COOK TIME** pad.

**NOTE:** If your recipe requires preheating, you may need to add additional time to the length of the cooking time.

 4 Touch the **number** pads to set the desired length of cooking time. The minimum cooking time you can set is 1 minute. The oven temperature that you set and the cooking time that you entered will be in the display.

 5 Touch the **DELAY START** pad.

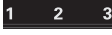
 6 Touch the **number** pads to set the time of day you want the oven to turn on and start cooking.

 7 Touch the **START** pad.

(continued on next page)

# OPERATING INSTRUCTIONS

## USING THE TIMED CONVECTION BAKING AND ROASTING FEATURES (on some models)

### HOW TO SET A DELAYED START AND AUTOMATIC STOP (continued)

**NOTE:** If you would like to check the times you have set, touch the **DELAY START** pad to check the start time you have set or touch the **COOK TIME** pad to check the length of cooking time you have set.

When the oven turns **ON** at the time of day you set, the display will show the cooking time countdown and the changing temperature starting at 100°F. (The temperature display will start to change once the oven temperature reaches 100°F.) When the oven reaches the temperature you set, 3 beeps will sound.

The oven will continue to cook for the set amount of time, then turn off automatically, unless the **Cook and Hold** feature was set. See the *Special Features of Your Oven Control* section.

After the oven turns off, the end-of-cycle tone will sound.



- 8 Touch the **CLEAR/OFF** pad to clear the display if necessary. Remove the food from the oven. Remember, even though the oven turns off automatically, food left in the oven will continue cooking after the oven turns off.

## SPECIAL FEATURES OF YOUR OVEN CONTROL

Your new touch pad control has additional features that you may choose to use. The following pages describe these features and how you may activate them.

The special feature modes can only be activated while the display is showing the time



of day. They remain in the control's memory until the steps are repeated.

When the display shows your choice, touch the **START** pad. The special features will remain in memory after a power failure.

### 12 HOUR SHUT-OFF





With this feature, should you forget and leave the oven on, the control will automatically turn off the oven after 12 hours during baking functions or after 3 hours during a broil function.

If you wish to turn **OFF** this feature, follow the steps below.

- 1 Touch the **BAKE** and **BROIL HI/LO** pads at the same time for 3 seconds until the display shows **SF**.  

- 2 Touch the **DELAY START** pad. The display will show **12 shdn** (12 hour shut-off). Touch the **DELAY START** pad again and the display will show **no shdn** (no shut-off).  

- 3 Touch the **START** pad to activate the no shut-off and leave the control set in this special features mode.  

### SELECT FAHRENHEIT OR CELSIUS TEMPERATURE

Your oven control is set to use the Fahrenheit temperature selections but you may change this to use the Celsius selections.

- 1 Touch the **BAKE** and **BROIL HI/LO** pads at the same time for 3 seconds until the display shows **SF**.  

- 2 Touch the **BROIL HI/LO** and **COOK TIME** pads at the same time. The display will show **F** (Fahrenheit).  

- 3 Touch the **BROIL HI/LO** and **COOK TIME** pads again at the same time. The display will show **C** (Celsius).  

- 4 Touch the **START** pad.  





# OPERATING INSTRUCTIONS

## SPECIAL FEATURES OF YOUR OVEN CONTROL

### TONES AT THE END OF A TIMED CYCLE

At the end of a timed cycle, 3 short beeps will sound followed by one beep every 6 seconds until the **CLEAR/OFF** pad is touched. This continual 6-second beep may be cancelled.

**To cancel the 6-second beep:**

-  1 Touch the **BAKE** and **BROIL HI/LO** pads at the same time for 3 seconds until the display shows **SF**.
-  2 Touch the **TIMER ON/OFF** pad. The display shows **CON BEEP** (continual beep) and **BEEP**. Touch the **TIMER ON/OFF** pad again. The display shows **BEEP**. (This cancels the one beep every 6 seconds.)
-  3 Touch the **START** pad.

### CONTROL LOCKOUT

Your control will allow you to lock out the touch pads so they cannot be activated when touched or cleaning the glass panel.

**To lock the controls:**

-  1 Touch the **9** and **0** touch pads at the same time for 3 seconds until the control beeps twice. The display will show **LOC** continuously and the time of day if not blacked out.



**NOTE:** All cooking and timing functions will be cancelled when locking out the control.

-  2 To unlock the control, touch the **9** and **0** touch pads at the same time for 3 seconds until the control beeps twice, and **LOC** will be removed from the display.

### 12-HOUR, 24-HOUR, OR CLOCK BLACKOUT

Your control is set to use a 12-hour clock.

If you would prefer to have a 24-hour military time clock or black out the clock display, follow the steps below.

-  1 Touch the **BAKE** and **BROIL HI/LO** pads at the same time for 3 seconds until the display shows **SF**.
-  2 Touch the **CLOCK** pad once. The display will show **12 hr**.
-  3 If this is the choice you want, touch the **START** pad.

Touch the **CLOCK** pad again to change to the 24-hour military time clock. The display will show **24 hr**. If this is the choice you want, touch the **START** pad.

Touch the **CLOCK** pad again to black out the clock display. The display will show **OFF**. If this is the choice you want, touch the **START** pad.





**NOTE:** If the clock is in the black-out mode, you will not be able to use the **DELAY START** function.

### COOK AND HOLD

Your new control has a cook and hold feature that keeps cooked foods warm for up to 3 hours after the cooking function is finished.

This feature can only be used when timed cooking.

To activate this feature, follow the steps below.

-  1 Touch the **BAKE** and **BROIL HI/LO** pads at the same time for 3 seconds until the display shows **SF**.
-  2 Touch the **COOK TIME** pad. The display will show **Hid OFF**.
-  3 Touch the **COOK TIME** pad again to activate the feature. The display will show **Hid ON**.
-  4 Touch the **START** pad to activate the cook and hold feature and leave the control set in this special features mode.

# OPERATING INSTRUCTIONS

## USING THE SABBATH FEATURE







*(DESIGNED FOR USE ON THE JEWISH SABBATH AND HOLIDAYS)*

The Sabbath feature can be used for baking/roasting in the oven only. It cannot be used for convection, broiling, self-cleaning or Delay Start cooking.

**NOTE:** The oven light comes on automatically when the door is opened and goes off when the door is closed. The bulb may be removed. See the Oven Light Replacement section. On models with a light switch on the control panel, the oven light may be turned on and left on.

### HOW TO SET FOR REGULAR BAKING/ROASTING (in Sabbath Mode)

Make sure the clock shows the correct time of day and the oven is off.

-  Press and hold **both** the **BAKE** and **BROIL HI/LO** pads, **at the same time**, until the display shows **SF**.
-  Tap the **DELAY START** pad until **SAb bAtH** appears in the display.
-  Touch the **START** pad and  $\triangleright$  will appear in the display.
-  Touch the **BAKE** pad. No signal will be given.
-  Using the **number** pads, enter the desired temperature between 170° and 550°. No signal or temperature will be given.
-  Touch the **START** pad.
- After a random delay period of approximately 30 seconds to 1 minute,  $\triangleright \triangleleft$  will appear in the display indicating that the oven is baking/roasting. If  $\triangleright \triangleleft$  doesn't appear in the display, start again at Step 4.









To adjust the oven temperature, touch the **BAKE** pad, enter the new temperature using the number pads, and touch the **START** pad.

**NOTE:** When the display shows  $\triangleright$  the oven is set in Sabbath. When the display shows  $\triangleright \triangleleft$  the oven is baking/roasting.

**NOTE:** The **CLEAR/OFF** and **COOK TIME** pads are active during the Sabbath feature.

### HOW TO SET FOR TIMED BAKING/ROASTING WITH IMMEDIATE START AND AUTOMATIC STOP (in Sabbath Mode)

Make sure the clock shows the correct time of day and the oven is off.

-  Press and hold **both** the **BAKE** and **BROIL HI/LO** pads, **at the same time**, until the display shows **SF**.
-  Tap the **DELAY START** pad until **SAb bAtH** appears in the display.
-  Touch the **START** pad and  $\triangleright$  will appear in the display.
-  Touch the **COOK TIME** pad.
-  Touch the **number** pads to set the desired length of cooking time between 1 minute and 9 hours and 99 minutes. The cooking time that you entered will be displayed.
-  Touch the **START** pad.
-  Touch the **BAKE** pad. No signal will be given.
-  Using the **number** pads, enter the desired temperature. No signal or temperature will be given.
-  Touch the **START** pad.
- After a random delay period of approximately 30 seconds to 1 minute,  $\triangleright \triangleleft$  will appear in the display indicating that the oven is baking/roasting. If  $\triangleright \triangleleft$  doesn't appear in the display, start again at Step 7.

# OPERATING INSTRUCTIONS

## USING THE SABBATH FEATURE

### HOW TO SET FOR TIMED BAKING/ ROASTING WITH IMMEDIATE START AND AUTOMATIC STOP (continued)

**NOTE:** When the display shows  $\supset$  the oven is set in Sabbath. When the display shows  $\supset \subset$  the oven is baking/roasting.

To adjust the oven temperature, touch the **BAKE** pad, enter the new temperature using the number pads, and touch the **START** pad.

When cooking is finished, the display will change from  $\supset \subset$  to  $\supset$  and **0:00** will appear, indicating that the oven has turned **OFF** but is still set in Sabbath. Remove the cooked food.

### HOW TO EXIT THE SABBATH FEATURE



1 Touch the **CLEAR/OFF** pad.

2 If the oven is cooking, wait for a random delay period of approximately 30 seconds to 1 minute, until only  $\supset$  is in the display.



and



3 Press and hold **both** the **BAKE** and **BROIL HI/LO** pads, at the same time, until the display shows **SF**.



4 Tap the **DELAY START** pad until **12 shdn** or **no shdn** appears in the display. **12 shdn** indicates that the oven will automatically turn off after 12 hours. **no shdn** indicates that the oven will not automatically turn off.



5 Touch the **START** pad.

**NOTE:** If a power outage occurred while the oven was in Sabbath, the oven will automatically turn off and stay off even when the power returns. The oven control must be reset.

# OPERATING INSTRUCTIONS

## HOW TO ADJUST THE OVEN THERMOSTAT

### ADJUSTING THE OVEN THERMOSTAT

You may find that your new oven cooks differently than the one it replaced. Use your new oven for a few weeks to become more familiar with it. If you still think your new oven is too hot or too cold, you can adjust the thermostat yourself.

Do not use thermometers, such as those found in grocery stores, to check the temperature setting of your oven. These thermometers may vary 20–40 degrees.

**NOTE:** This adjustment will not affect the broiling or the self-cleaning temperatures. The adjustment will be retained in memory after a power failure.

The oven temperature can be increased (+) or decreased (-) as much as 35.

### TO INCREASE (+) TEMPERATURE ADJUSTMENT

 **1** Touch the **BAKE** and **BROIL HI/Lo** for the same time for 3 seconds until the display shows **SF**.

 **2** Touch **BAKE** and **0** will display.

 **3** Using the number pad, enter the temperature amount you wish to increase (+). For example, to increase (+) the oven temperature 15, touch **1** and **5**.

 **4** Touch **START** to set the increased (+) temperature. normalement.

### TO DECREASE (-) TEMPERATURE ADJUSTMENT

 **1** Touch the **BAKE** and **BROIL HI/Lo** pads at the same time for 3 seconds until the display shows **SF**.

 **2** Touch **BAKE** and **0** will display.

 **3** Using the number pad, enter the temperature amount you wish to decrease (-). For example, to decrease (-) the oven temperature 15, touch **1** and **5**.

 **4** Touch **BAKE** again, the decreased (-) temperature will appear in the display.

 **5** Touch **START** to set the decreased (-) temperature.

**NOTE:** Once the temperature is increased or decreased, the display will show the adjusted temperature until it is readjusted.

**NOTE:** The thermostat adjustment for Baking will also affect Convection Baking or Convection Roasting.

## BAKING TIP

### THE TYPE OF MARGARINE WILL AFFECT BAKING PERFORMANCE

*Most recipes for baking have been developed using high fat products such as butter or margarine (80% fat). If you decrease the fat, the recipe may not give the same results as with a higher fat product.*

*Recipe failure can result if cakes, pies, pastries, cookies or candies are made with low fat spreads. The lower the fat content of a spread product, the more noticeable these differences become.*

Federal standards require products labeled “margarine” to contain at least 80% fat by weight. Low fat spreads, on the other hand, contain less fat and more water. The high moisture content of these spreads affects the texture and flavor of baked goods. For best results with your old favorite recipes, use margarine, butter or stick spreads containing at least 70% vegetable oil.



# OPERATING INSTRUCTIONS

## USING THE ELECTRIC WARMING DRAWER

The warming drawer will keep hot, cooked foods at serving temperature. Always start with

hot food. Do not use to heat cold food other than crisping crackers, chips or dry cereal.

### TO USE THE WARMING DRAWER

-  1 Touch the **WARMING DRAWER** pad. “Hot” and “1” are lit on the display and “Set” begins to blink.
-  2 On the number pad, press **1** for Low, **2** for Medium or **3** for High. The display “1” changes corresponding to the number pad selected.
-  3 Touch the **START** pad. “Hot” and the number remain lit. “Set” stops blinking.

To cancel, touch the **WARMING DRAWER** pad.

**NOTE:** Touching the **CLEAR/OFF** pad does not turn the warming drawer off.

#### NOTES:

- The warming drawer cannot be used during a self-clean cycle.
- The warming drawer has three settings: 1, 2 and 3. These settings maintain different temperature levels in the warming drawer.
- On some models, if using the oven at the same time as the warming drawer, only the oven settings will be displayed.

Number Pad	Setting
1	Lo (pies)
2	Med (casseroles)
3	Hi (meats)

### WHEN USING THE WARMING DRAWER

The warming drawer will keep hot, cooked foods at serving temperature. Always start with hot food. Do not use to heat cold food other than crisping crackers, chips or dry cereal.

**Do not line the warming drawer or pan with aluminum foil. Foil is an excellent heat insulator and will trap heat beneath it. This will upset the performance of the drawer and could damage the interior finish.**

**Allow approximately 25 minutes for the warming drawer to preheat.**

- Do not put liquid or water in the warming drawer.
- For moist foods, cover them with a lid or aluminum foil.
- For crisp foods, leave them uncovered.
- Food should be kept hot in its cooking container or transferred to a heat-safe serving dish.

**⚠ CAUTION:** Plastic containers or plastic wrap will melt if in direct contact with the drawer, pan or a hot utensil. Melted plastic may not be removable and is not covered under your warranty.

- Remove serving spoons, etc., before placing containers in warming drawer.

# OPERATING INSTRUCTIONS

## USING THE ELECTRIC WARMING DRAWER

### TEMPERATURE SELECTION CHART

To keep several different foods hot, set the control to the food needing the highest setting.

- The temperature, type and amount of food, and the time held will affect the quality of the food.
- Food in heat-safe glass and glass-ceramic utensils may need a higher control setting as compared to food in metal utensils.
- Repeated opening of the drawer allows the hot air to escape and the food to cool.
- Allow extra time for the temperature inside the drawer to stabilize after adding items.
- With large loads it may be necessary to use a higher warming drawer setting and cover some of the cooked food items.
- Do not use plastic containers or plastic wrap.

Food Type	Control Setting
Bacon	3
Breads	2
Casserole	2
Chicken, Fried	3
Eggs, Scrambled	2
Fish	3
Gravy and Sauces	3
Ham	3
Muffins	2
Onion Rings	3
Pies	1
Pizza	3
Potatoes, Baked	3
Potatoes, Mashed	2
Tortilla Chips	1

**⚠ CAUTION:** Do not keep food in the warming drawer for more than two hours.

### TO CRISP STALE ITEMS

- Place food in low-sided dishes or pans.
- Preheat on **1** setting.
- Check crispness after 45 minutes. Add time as needed.

### TO WARM SERVING BOWLS AND PLATES

To warm serving bowls and plates, set the control on **1**.

- Use only heat-safe dishes.
- If you want to heat fine china, please check with the manufacturer of the dishes for their maximum heat tolerance.
- You may warm empty serving dishes while preheating the drawer.

**⚠ CAUTION:** Dishes will be hot. Use pot holders or oven mitts when removing hot dishes.

## USING THE SELF-CLEANING OVEN

### BEFORE A CLEAN CYCLE

For the first self-clean cycle, we recommend venting your kitchen with an open window or using a ventilation fan or hood.

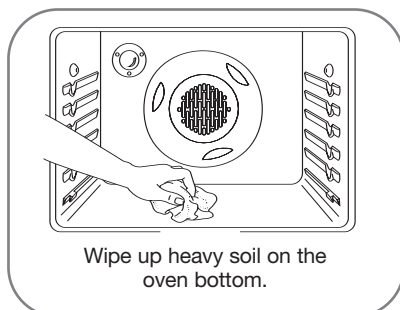

Remove the broiler pan, broiler grid, all cookware, probe and any aluminum foil from the oven—they cannot withstand the high cleaning temperatures.

**NOTE:** If your oven is equipped with nickel oven shelves, remove them before you begin the self-clean cycle.

Soil on the front frame of the range and outside the gasket on the door will need to be cleaned by hand. Clean these areas with hot water, soap-filled scouring pads or cleansers such as Soft Scrub®. Rinse well with clean water and dry.

Do not clean the gasket. The fiberglass material of the oven door gasket cannot withstand abrasion. It is essential for the gasket to remain intact. If you notice it becoming worn or frayed, replace it.

Wipe up any heavy spillovers on the oven bottom.

Make sure the oven light bulb cover is in place and the oven light is off.

**IMPORTANT:** The health of some birds is extremely sensitive to the fumes given off during the self-cleaning cycle of any range. Move birds to another well ventilated room.

**NOTE:** Use caution when opening the oven after the self-clean cycle has ended. The oven may still be hot.

### HOW TO SET THE OVEN FOR CLEANING



1 Touch the **SELF CLEAN** pad.



2 Using the number pads, enter the desired clean time, if a time other than 4 hours is needed. Clean cycle time is normally 4 hours. You can change the clean time to any time between 3 hours and 5 hours, depending on how dirty your oven is.



3 Touch the **START** pad.

The door locks automatically. The display will show the clean time remaining. It will not be possible to open the oven door until the temperature drops below the lock temperature and the **LOCKED DOOR** light goes off.

The oven shuts off automatically when the clean cycle is complete.

4 When the **LOCKED DOOR** light is off, the door will unlock automatically.

- The words **LOCK DOOR** will flash and the oven control will signal if you set the clean cycle and forget to close the oven door.
- To stop a clean cycle, touch the **CLEAR/OFF** pad. When the **LOCKED DOOR** light goes off indicating the oven has cooled below the locking temperature, open the door.





# OPERATING INSTRUCTIONS

## USING THE SELF-CLEANING OVEN

The oven door must be closed and all controls set correctly for the cycle to work properly.

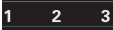
### HOW TO DELAY THE START OF CLEANING

Make sure the clock shows the correct time of day.

-  1 Touch the **SELF CLEAN** pad.
-  2 Using the **number** pads, enter the desired clean time.
-  3 Touch the **DELAY START** pad. The earliest start time you can set will appear in the display.
-  4 Using the **number** pads, enter the time of day you want the clean cycle to start.
-  5 Touch the **START** pad.

The door locks automatically. The display will show the start time. It will not be possible to open the oven door until the temperature drops below the lock temperature and the **LOCKED DOOR** light goes off.

### AFTER A CLEAN CYCLE

You may notice some white ash in the oven. Wipe it up with a damp cloth after the oven cools.

If white spots remain, remove them with a soap-filled scouring pad and rinse thoroughly with a vinegar and water mixture.

These deposits are usually a salt residue that cannot be removed by the clean cycle.

If the oven is not clean after one clean cycle, repeat the cycle.

The oven shuts off automatically when the clean cycle is complete.

- 6 When the **LOCKED DOOR** light is off, the door will unlock automatically.
- The words **LOCK DOOR** will flash and the oven control will signal if you set the clean cycle and forget to close the oven door.
  - To stop a clean cycle, touch the **CLEAR/OFF** pad. When the **LOCKED DOOR** light goes off indicating the oven has cooled below the locking temperature, open the door.

- You cannot set the oven for cooking until the oven is cool enough for the door to unlock.
- While the oven is self-cleaning, you can touch the **CLOCK** pad to display the time of day. To return to the clean countdown, touch the **COOK TIME** pad.
- If the shelves become hard to slide, apply a small amount of vegetable oil or cooking oil to a paper towel and wipe the edges of the oven shelves with the paper towel.

# CARE AND CLEANING OF THE RANGE

## CARE AND CLEANING

**Be sure electrical power is off and all surfaces are cool before cleaning any part of the range.**



If your range is removed for cleaning, servicing or any reason, be sure the anti-tip device is re-engaged properly when the range is replaced. Failure to take this precaution could result in tipping of the range and cause injury.



**⚠ CAUTION:** Do not operate the cooktop without all burner parts and grates in place.

The electrode of the spark igniter is exposed when the burner head is removed. When one burner is turned to **LITE**, all the burners spark. Do not attempt to disassemble or clean around any burner while another burner is on. An electric shock may result, which could cause you to knock over hot cookware.

### SEALED BURNER ASSEMBLIES

Turn all controls **OFF** before removing the burner parts.

The burner grates, caps, and burner heads can be lifted off, making them easy to clean. The electrodes are not removable.

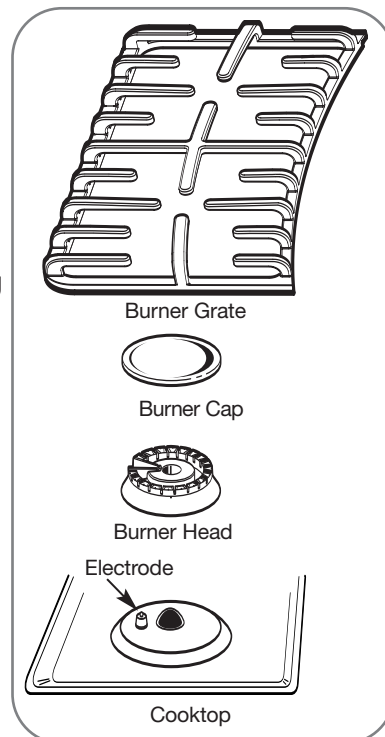

# CARE AND CLEANING OF THE RANGE

## BURNER CAPS AND HEADS

### BURNER CAPS

Lift off when cool. Wash burner caps in hot, soapy water and rinse with clean water. You may scour with a plastic scouring pad to remove burned-on food particles.

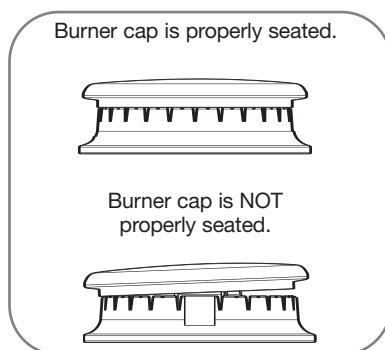

### AFTER CLEANING

Before putting the burner caps and burner heads back, shake out excess water and then dry them thoroughly by setting in a warm oven for 30 minutes.

### REPLACEMENT

Replace burner heads and caps over the electrodes on the cooktop, in the correct locations according to their size. There are two small burner heads and caps, one medium, one large and one extra large burner head and cap.

### BURNER HEADS

For proper ignition, make sure the small hole in the section that fits over the electrode is kept open. A sewing needle or wire twist-tie works well to unclog it.

The slits in the burner heads must be kept clean at all times for an even, unhampered flame.

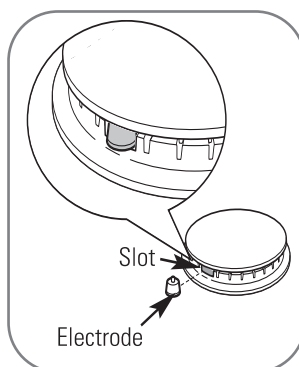

Clogged or dirty burner ports or electrodes will not allow the burner to operate properly.

Any spill on or around an electrode must be carefully cleaned. Take care to not hit an electrode with anything hard or it could be damaged.

You should clean the burner caps and heads routinely, especially after bad spillovers which could clog the openings. Lift off when cool.

To remove burned-on food, soak the burner heads in a solution of mild liquid detergent and hot water for 20–30 minutes. For more stubborn stains, use a toothbrush.

### NOTES:

- Do not use steel wool or scouring powders to clean the burners.
- Burners will not light if the cap is removed.

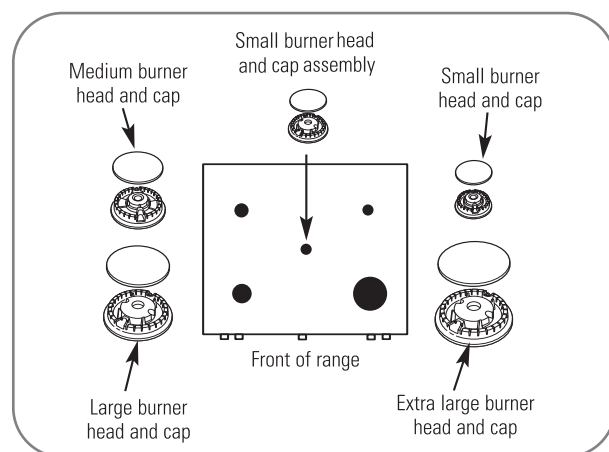

# CARE AND CLEANING OF THE RANGE

## BURNER GRATES

Your range has three professional-style grates. These grates are position-specific. For maximum stability, these grates should only be used in their proper position; they cannot be interchanged left to right or front to back. Make sure the front portion of both grates is in front. The middle grate has a bow in front. Make sure the bowed portion is toward the front of the range.

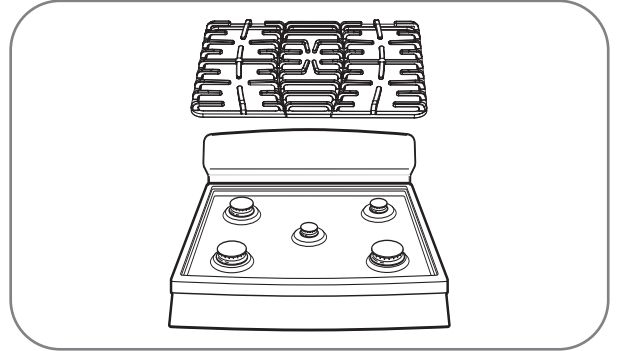

### CLEANING

Lift out when cool. Grates should be washed regularly and, of course, after spillovers. Wash them in hot, soapy water and rinse with clean water. When replacing the grates, be sure they are positioned securely over the burners. Replace the grates so that continuous arcs are formed with the center ribs of all three grates. The grates may be cleaned in a dishwasher.

Do not operate a burner for an extended period of time without cookware on the grate. The finish on the grate may chip without cookware to absorb the heat.

To get rid of burned-on food, place the grates in a covered container. Add 1/4 cup ammonia and let them soak several hours or overnight. Wash, rinse well and dry.

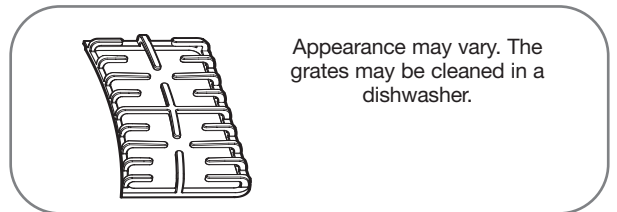

Although they are durable, the grates will gradually lose their shine, regardless of the best care you can give them. This is due to their continual exposure to high temperatures. You will notice this sooner with lighter color grates.

**NOTE: Do not clean the grates in a self-cleaning oven.**

## COOKTOP SURFACE

To avoid damaging the porcelain enamel surface of the cooktop and to prevent it from becoming dull, clean up spills right away. Foods with a lot of acid (tomatoes, sauerkraut, fruit juices, etc.) or foods with high sugar content could cause a dull spot if allowed to set. When the surface has cooled, wash and rinse.

For other spills such as fat splatterings, etc., wash with soap and water once the surface has cooled. Then rinse and polish with a dry cloth.

**NOTE: Do not store flammable materials in an oven, drawer or near the cooktop. Do not store or use combustible materials, gasoline or other flammable vapors and liquids in the vicinity of this or any other appliance.**

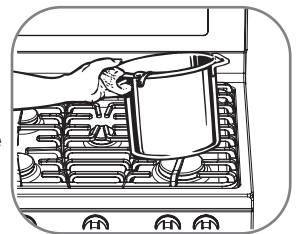

**NOTE: Do not lift the cooktop. Lifting the cooktop can lead to damage and improper operation of the range.**

# CARE AND CLEANING OF THE RANGE

## STAINLESS STEEL SURFACES

**Do not use a steel wool pad; it will scratch the surface.**

To clean the stainless steel surface, use warm sudsy water or a stainless steel cleaner or polish. Always wipe the surface in the direction of the grain. Follow the cleaner instructions for cleaning the stainless steel surface.

To inquire about purchasing stainless steel appliance cleaner or polish, or to find the location of a dealer nearest you, please call our toll-free customer service number:

**1-800-243-0000**

or visit our website at:

**us.lgservice.com**

## OVEN AIR VENTS

Never block the vents (air openings) of the range. They provide the air inlet and outlet that are necessary for the range to operate properly with correct combustion.

Air openings are located at the rear of the cooktop, at the top and bottom of the oven door, and at the bottom of the range, under the warming drawer.

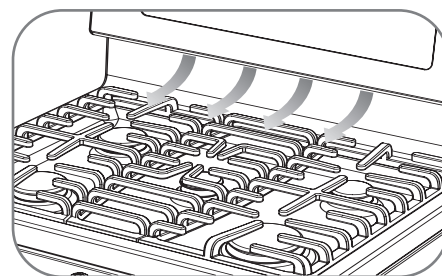

## CONTROL PANEL

 Lock out the touch pads before cleaning.

See the *Control Lockout* information in the *Special Features of Your Oven Control* section in this manual.

Clean up splatters with a damp cloth.

You may also use a glass cleaner.

Remove heavier soil with warm soapy water.

Do not use abrasives of any kind.

*Unlock the touch pads after cleaning.*

## FRONT MANIFOLD PANEL AND KNOBS

It's a good idea to wipe the control panel after each use of the oven. Use a damp cloth to clean or rinse. For cleaning, use mild soap and water or a 50/50 solution of vinegar and water. For rinsing, use clean water. Polish dry with a soft cloth.

Do not use abrasive cleansers, strong liquid cleaners, plastic scouring pads or oven cleaners on the control panel—they will damage the finish.

Do not try to bend knobs by pulling them up or down or by hanging a towel or other such loads. This can damage the gas valve shaft.

The control knobs may be removed for easier cleaning.

Make sure the knobs are in the **OFF** positions and pull them straight off the stems for cleaning.

To reinstall the knobs, make sure the knob has the **OFF** position centered at the top and slide the knob directly onto the stem.

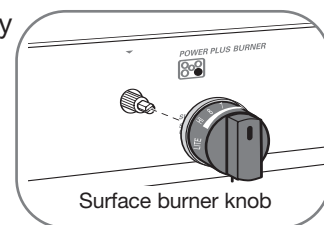

# CARE AND CLEANING OF THE RANGE

## OVEN DOOR

The oven door is removable, but it is heavy. You may need help removing and replacing the door.

### TO REMOVE THE DOOR

To remove the door, open it a few inches to the special stop position that will hold the door open. Grasp firmly on each side and lift the door straight up and off the hinges.

**NOTE:** Be careful not to place hands between the hinge and the oven door frame as the hinge could snap back and pinch fingers.

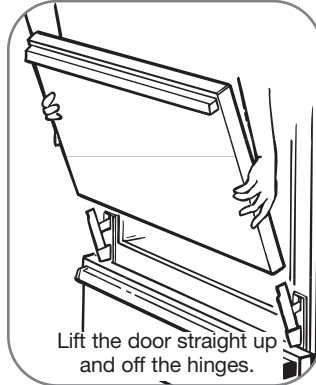

### TO REPLACE THE DOOR

To replace the door, make sure the hinges are in the special stop position. Position the slots in the bottom of the door squarely over the hinges. Then lower the door slowly and evenly over both hinges at the same time. If the hinges snap back against the oven frame, pull them back out.

### TO CLEAN THE INSIDE OF THE DOOR

- Do not allow excess water to run into any holes or slots in the door.
- Because the area inside the gasket is cleaned during the self clean cycle, you do not need to clean this by hand. Any soap left on the liner causes additional stains when the oven is heated.
- The area outside the gasket can be cleaned with a soap-filled plastic scouring pad.

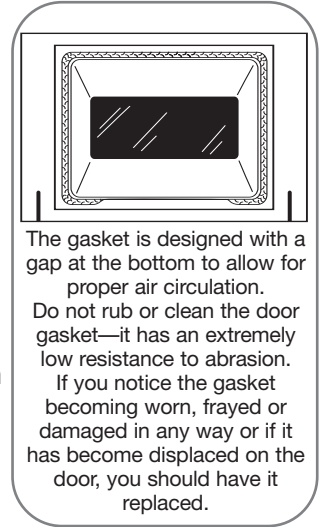

### TO CLEAN THE OUTSIDE OF THE DOOR

- Use soap and water to thoroughly clean the top, sides and front of the oven door. Rinse well. You may also use a glass cleaner to clean the glass on the outside of the door.
- Spillage of marinades, fruit juices, tomato sauces and basting materials containing acids may cause discoloration and should be wiped up immediately. When the surface is cool, clean and rinse.
- Do not use oven cleaners, cleansing powders or harsh abrasives on the outside of the door.

## OVEN BOTTOM

The oven bottom has a porcelain enamel finish. To make cleaning easier, protect the oven bottom from excessive spillovers by placing a cookie sheet on the shelf below the shelf you are cooking on. This is particularly important when baking a fruit pie or other foods with a high acid content. Hot fruit fillings or other foods that are highly acidic (such as tomatoes, sauerkraut and sauces with vinegar or lemon juice) may cause pitting and damage to the porcelain enamel surface and should be wiped up immediately.

We don't recommend using aluminum foil on the oven bottom. It can affect air flow if the holes are blocked and it can concentrate heat at the bottom of the oven, resulting in poor baking performance.

To clean up spillovers, use soap and water, an abrasive cleaner or soap-filled scouring pad. Rinse well to remove any soap before self-cleaning.

Always make sure that the oven bottom is properly in place after cleaning.

# CARE AND CLEANING OF THE RANGE

## BROILER PAN AND GRID

After broiling, remove the broiler pan from the oven. Remove the grid from the pan. Carefully pour out grease from the pan into a proper container. Wash and rinse the broiler pan and grid in hot water with a soap-filled or plastic scouring pad.

If food has burned on, sprinkle the grid with detergent while hot and cover with wet paper

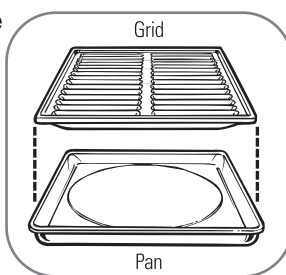

towels or a dishcloth. Soaking the pan will remove burned-on foods.

The broiler pan and grid may be cleaned with a commercial oven cleaner.

Both the broiler pan and grid can also be cleaned in a dishwasher.

Do not store a soiled broiler pan and grid anywhere in the range.

**NOTICE:** Do not clean the broiler pan or grid in a self-cleaning oven.

## OVEN SHELVES AND DRAWER RACKS

If your oven is equipped with nickel oven shelves, they should be removed from the oven before beginning the self-clean cycle.

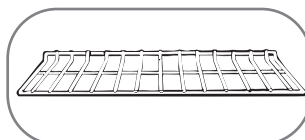

To clean the nickel shelves, use an abrasive cleanser. After cleaning, rinse the shelves with clean water and dry with a clean cloth. If the shelves ever become hard to slide, wipe the shelf edges or oven shelf supports with vegetable oil.

## OVEN LIGHT REPLACEMENT

**⚠ CAUTION:** Before replacing your oven light bulb, disconnect the electrical power to the range at the main fuse or circuit breaker panel. Be sure to let the light cover and bulb cool completely.

The oven light bulb is covered with a removable glass cover that is held in place with a bail-shaped wire. Remove the oven door, if desired, to reach cover easily.

**To remove:**

1 Disconnect electrical power from the range.

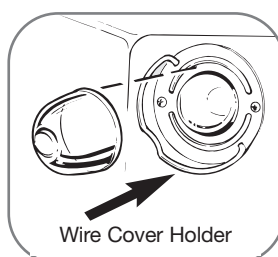

2 Hold a hand under the cover so it doesn't fall when released. With fingers of the same hand, firmly push back the wire cover holder. Lift off the cover. **Do not remove any screws to remove the cover.**

3 Do not touch hot bulb with a wet cloth. Replace bulb with a 40-watt household appliance bulb.

**To replace cover:**

1 Place it into the groove of the light receptacle. Pull the wire forward to the center of the cover until it snaps into place. When in place, the wire holds the cover firmly. Be certain the wire is in the depression in the center of the cover.

2 Connect electrical power to the range.

# CARE AND CLEANING OF THE RANGE

## REMOVABLE WARMING DRAWER

**NOTE:** Before performing any adjustments, cleaning or service, disconnect the range electrical power supply at the household distribution panel by removing the fuse or switching off the circuit breaker. Make sure the warming drawer heating element is cool.

Most cleaning can be done with the drawer in place. However, the drawer may be removed if further cleaning is needed. Use soap and warm water to thoroughly clean.

### To remove the drawer:

1 Pull the drawer straight out until it stops.

2 Press the left rail release up and press the right rail release down, while pulling the drawer forward and free.

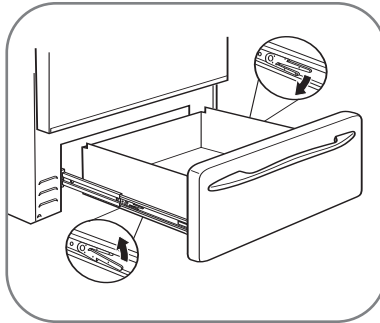

### To replace the drawer:

1 Place the left drawer rail around the inner left rail guide and slide it in slightly to hook it.

2 Place the right drawer rail around the inner right rail guide and slide it in slightly to hook it.

3 Slide the drawer all the way in.

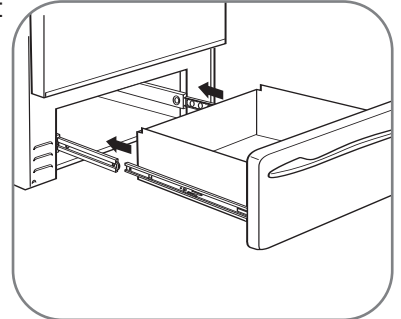

# TROUBLESHOOTING

## BEFORE CALLING FOR SERVICE

Before you call for service, review this list. It may save you time and expense. This list includes common occurrences that are not the result of a defect in workmanship or materials.

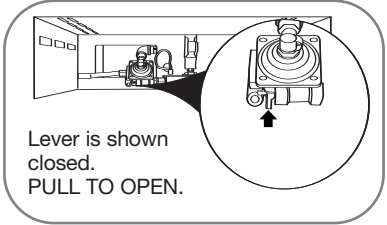
Problem	Possible Causes	Solutions
<p><b>Top burners do not light or do not burn evenly. (The front right burner is designed to have slightly smaller flames between the 6 and 9 o'clock positions. This is normal.)</b></p>	<ul style="list-style-type: none"> <li>• Plug on range is not completely inserted in the electrical outlet.</li> <li>• Burner slits on the side of the burner may be clogged.</li> <li>• Improper burner assembly.</li> </ul>	<ul style="list-style-type: none"> <li>• Make sure electrical plug is plugged into a live, properly grounded outlet.</li> <li>• Remove the burners and clean them. Check the electrode area for burned-on food or grease. See the <i>Care and Cleaning of the Range</i> section.</li> <li>• Make sure the burner parts are installed correctly. See the <i>Care and Cleaning of the Range</i> section.</li> </ul>
<p><b>Burner flames very large or yellow</b></p>	<ul style="list-style-type: none"> <li>• Improper air to gas ratio.</li> </ul>	<ul style="list-style-type: none"> <li>• If range is connected to LP gas, contact the person who installed your range or made the conversion.</li> </ul>
<p><b>Surface burners light but oven does not</b></p>	<ul style="list-style-type: none"> <li>• The oven gas shut-off valve may have accidentally been moved during cleaning or moving.</li> </ul>	<ul style="list-style-type: none"> <li>• To check the oven gas shut-off valve, remove the warming drawer (see the <i>Care and Cleaning of the Range</i> section) and look for the gas shut-off lever at the back of the range.</li> </ul>  <p>Lever is shown closed. PULL TO OPEN.</p>
<p><b>Control signals after entering cooking time or start time</b></p>	<ul style="list-style-type: none"> <li>• You forgot to enter a bake temperature or cleaning time.</li> </ul>	<ul style="list-style-type: none"> <li>• Touch the <b>BAKE</b> pad and desired temperature or the <b>SELF CLEAN</b> pad and desired clean time.</li> </ul>
<p><b>Food does not bake or roast properly in the upper oven</b></p>	<ul style="list-style-type: none"> <li>• Oven controls improperly set.</li> <li>• Shelf position is incorrect.</li> <li>• Incorrect cookware or cookware of improper size being used.</li> <li>• Oven thermostat needs adjustment.</li> <li>• Clock not set correctly.</li> <li>• Aluminum foil used improperly in the oven.</li> <li>• Oven bottom not securely seated in position.</li> </ul>	<ul style="list-style-type: none"> <li>• See the <i>Using the Oven</i> section.</li> <li>• See the <i>Using the Oven</i> section.</li> <li>• See the <i>Using the Oven</i> section.</li> <li>• See the <i>Adjusting the Oven Thermostat</i> section.</li> <li>• See the <i>Using the Clock and Timer</i> section.</li> <li>• See the <i>Care and Cleaning of the Range</i> section.</li> <li>• See the <i>Installation Instructions</i>.</li> </ul>

## BEFORE CALLING FOR SERVICE

Problem	Possible Causes	Solutions
<b>Food does not broil properly in the oven</b>	<ul style="list-style-type: none"> <li>• Oven controls improperly set.</li> <li>• Oven door not closed.</li> <li>• Improper shelf position being used.</li> <li>• Food being cooked in a hot pan.</li> <li>• Cookware not suited for broiling.</li> <li>• Aluminum foil used on the broiling pan and grid has not been fitted properly and slit as recommended.</li> <li>• Oven bottom not securely seated in position.</li> </ul>	<ul style="list-style-type: none"> <li>• Make sure you touch the <b>BROIL HI/LO</b> pad.</li> <li>• See the <i>Using the Oven</i> section.</li> <li>• See the <i>Broiling Guide</i>.</li> <li>• Use the broiling pan and grid that came with your range. Make sure it is cool.</li> <li>• Use the broiling pan and grid that came with your range.</li> <li>• See the <i>Using the Oven</i> section.</li> <li>• See the <i>Installation Instructions</i>.</li> </ul>
<b>Oven temperature too hot or too cold</b>	<ul style="list-style-type: none"> <li>• Oven thermostat needs adjustment.</li> </ul>	<ul style="list-style-type: none"> <li>• See the <i>Adjusting the Oven Thermostat</i> section.</li> </ul>
<b>Clock and timer do not work</b>	<ul style="list-style-type: none"> <li>• Plug on range is not completely inserted in the electrical outlet.</li> <li>• A fuse in your home may be blown or the circuit breaker tripped.</li> <li>• Oven controls improperly set.</li> </ul>	<ul style="list-style-type: none"> <li>• Make sure electrical plug is plugged into a live, properly grounded outlet.</li> <li>• Replace the fuse or reset the circuit breaker.</li> <li>• See the <i>Using the Clock and Timer</i> section.</li> </ul>
<b>Oven light does not work</b>	<ul style="list-style-type: none"> <li>• Light bulb is loose or defective.</li> <li>• Plug on range is not completely inserted in the electrical outlet.</li> </ul>	<ul style="list-style-type: none"> <li>• Tighten or replace the bulb.</li> <li>• Make sure electrical plug is plugged into a live, properly grounded outlet.</li> </ul>
<b>Oven will not self-clean</b>	<ul style="list-style-type: none"> <li>• The oven temperature is too high to set a self-clean operation.</li> <li>• Oven controls improperly set.</li> </ul>	<ul style="list-style-type: none"> <li>• Allow the range to cool to room temperature and reset the controls.</li> <li>• See the <i>Using the Self-Cleaning Oven</i> section.</li> </ul>
<b>“Crackling” or “popping” sound</b>	<p>This is the sound of the metal heating and cooling during both the cooking and cleaning functions.</p>	<ul style="list-style-type: none"> <li>• This is normal.</li> </ul>
<b>Excessive smoking</b>	<ul style="list-style-type: none"> <li>• Excessive soil.</li> </ul>	<ul style="list-style-type: none"> <li>• Touch the <b>CLEAR/OFF</b> pad. Open the windows to rid the room of smoke. Wait until the <b>LOCKED DOOR</b> light goes off. Wipe up the excess soil and reset the clean cycle.</li> </ul>
	<ul style="list-style-type: none"> <li>• This is normal in a new oven and will disappear in time.</li> </ul>	<ul style="list-style-type: none"> <li>• To speed the process, set a self-clean cycle for a minimum of 3 hours. See the <i>Using the Self-Cleaning Oven</i> section.</li> </ul>

# TROUBLESHOOTING

## BEFORE CALLING FOR SERVICE

Problem	Possible Causes	Solutions
Oven door will not open after a clean cycle	<ul style="list-style-type: none"> <li>Oven too hot.</li> </ul>	<ul style="list-style-type: none"> <li>Allow the oven to cool below locking temperature.</li> </ul>
Oven not clean after a clean cycle	<ul style="list-style-type: none"> <li>Oven controls not properly set.</li> <li>Oven was heavily soiled.</li> </ul>	<ul style="list-style-type: none"> <li>See the <i>Using the Self-Cleaning Oven</i> section.</li> <li>Clean up heavy spillovers before starting the clean cycle. Heavily soiled ovens may need to self-clean again or for a longer period of time.</li> </ul>
“LOCK DOOR” flashes in the display	<ul style="list-style-type: none"> <li>The self-clean cycle has been selected but the door is not closed.</li> </ul>	<ul style="list-style-type: none"> <li>Close the oven door.</li> </ul>
LOCKED DOOR light is on when you want to cook	<ul style="list-style-type: none"> <li>The oven door is locked because the temperature inside the oven has not dropped below the locking temperature.</li> </ul>	<ul style="list-style-type: none"> <li>Touch the <b>CLEAR/OFF</b> pad. Allow the oven to cool.</li> </ul>
“F—and a number or letter” flash in the display	<ul style="list-style-type: none"> <li>You have a function error code.</li> <li>If the function code repeats.</li> </ul>	<ul style="list-style-type: none"> <li>Touch the <b>CLEAR/OFF</b> pad. Allow the oven to cool for one hour. Put the oven back into operation.</li> <li>Disconnect all power to the range for 5 minutes and then reconnect power. If the function error code repeats, call for service.</li> </ul>
Oven shelves are difficult to slide	<ul style="list-style-type: none"> <li>The nickel shelves (if so equipped) were cleaned in a self-clean cycle.</li> </ul>	<ul style="list-style-type: none"> <li>Apply a small amount of vegetable oil to a paper towel and wipe the edges of the oven shelves with the paper towel. Do not spray with Pam® or other lubricant sprays.</li> </ul>
“Probe” appears in the display (convection models)	<ul style="list-style-type: none"> <li>This is reminding you to enter a probe temperature after plugging in the probe.</li> </ul>	<ul style="list-style-type: none"> <li>Enter a probe temperature.</li> </ul>
Display goes blank	<ul style="list-style-type: none"> <li>A fuse in your home may be blown or the circuit breaker tripped.</li> <li>The clock is in the black-out mode.</li> </ul>	<ul style="list-style-type: none"> <li>Replace the fuse or reset the circuit breaker.</li> <li>See the <i>Special Features of Your Oven Control</i> section.</li> </ul>
Display flashes	<ul style="list-style-type: none"> <li>Power failure.</li> </ul>	<ul style="list-style-type: none"> <li>Reset the clock.</li> </ul>
Unable to get the display to show “SF”	<ul style="list-style-type: none"> <li>Oven control pads were not pressed properly.</li> </ul>	<ul style="list-style-type: none"> <li>The <b>BAKE</b> and <b>BROIL HI/LO</b> pads must be touched at the same time and held for 3 seconds.</li> </ul>
Power outage, clock flashes	<ul style="list-style-type: none"> <li>Power outage or surge.</li> </ul>	<ul style="list-style-type: none"> <li>Reset the clock. If the oven was in use, you must reset it by touching the <b>CLEAR/OFF</b> pad, setting the clock and resetting any cooking function.</li> </ul>

## BEFORE CALLING FOR SERVICE

Problem	Possible Causes	Solutions
<b>“Burning” or “oily” odor emitting from the vent</b>	<ul style="list-style-type: none"> <li>This is normal in a new oven and will disappear in time.</li> </ul>	<ul style="list-style-type: none"> <li>To speed the process, set a self-clean cycle for a minimum of 3 hours. See the <i>Using the Self-Cleaning Oven</i> section.</li> </ul>
<b>Strong odor</b>	<ul style="list-style-type: none"> <li>An odor from the insulation around the inside of the oven is normal for the first few times the oven is used.</li> </ul>	<ul style="list-style-type: none"> <li>This is temporary.</li> </ul>
<b>Fan noise (convection models)</b>	<ul style="list-style-type: none"> <li>The convection fan may turn on and off automatically.</li> </ul>	<ul style="list-style-type: none"> <li>This is normal. The convection fan will run until the function is over or the door is opened.</li> </ul>
<b>Convection fan not working (convection models)</b>	<ul style="list-style-type: none"> <li>Preheat temperature not reached.</li> </ul>	<ul style="list-style-type: none"> <li>Fan will start automatically once the preheat temperature is reached.</li> </ul>
<b>Drawer does not slide smoothly or drags</b>	<ul style="list-style-type: none"> <li>The drawer is out of alignment.</li> <li>Drawer is over-loaded or load is unbalanced.</li> </ul>	<ul style="list-style-type: none"> <li>Fully extend the drawer and push it all the way in. See the <i>Care and Cleaning of the Range</i> section.</li> <li>Reduce weight. Redistribute drawer contents.</li> </ul>
<b>Warming drawer will not work</b>	<ul style="list-style-type: none"> <li>A fuse in your home may be blown or the circuit breaker tripped.</li> <li>The oven is self-cleaning.</li> <li>Controls improperly set.</li> </ul>	<ul style="list-style-type: none"> <li>Replace the fuse or reset the circuit breaker.</li> <li>Wait for the self-clean cycle to finish and the oven to cool.</li> <li>See the <i>Using the Electric Warming Drawer</i> section.</li> </ul>
<b>Excessive condensation in the drawer</b>	<ul style="list-style-type: none"> <li>Liquid in drawer.</li> <li>Uncovered foods.</li> <li>Temperature setting too high.</li> </ul>	<ul style="list-style-type: none"> <li>Remove liquid.</li> <li>Cover food with lid or aluminum foil.</li> <li>Reduce temperature setting.</li> </ul>
<b>Food dries out in the lower oven drawer or warming drawer</b>	<ul style="list-style-type: none"> <li>Moisture escaping.</li> <li>Drawer not fully closed.</li> </ul>	<ul style="list-style-type: none"> <li>Cover food with lid or aluminum foil.</li> <li>Push drawer in until latch engages.</li> </ul>

# NOTES

---

**LG ELECTRONICS, INC.  
LG GAS RANGE LIMITED WARRANTY — USA / CANADA**



LG Electronics Inc. will repair or replace your product, at LG's option, if it proves to be defective in material or workmanship under normal use, during the warranty period set forth below, effective from the date of original consumer purchase of the product. This limited warranty is good only to the original purchaser of the product.

<p><b>WARRANTY PERIOD:</b>  <b>LABOR: One year</b> from date of original purchase  <b>PARTS: One year</b> from date of original purchase</p> <p><b>WHAT IS COVERED:</b>  <b>Any part</b> of the range which fails due to a defect in materials or workmanship. During this full <b>one-year warranty</b>, LG will also provide, <b>free of charge</b>, all labor and in-home service to replace the defective part.</p>	<p><b>HOW SERVICE IS HANDLED:</b></p> <p><b>In-Home Service:</b>  Please retain dealer's dated bill of sale as evidence of the Date of Purchase for proof of warranty, and submit a copy of the bill of sale to the service person at the time warranty service is provided.</p> <p>Please call <b>1-800-243-0000</b> and choose the appropriate option to locate your nearest LG Authorized Service Center.</p> <p>Or visit our Web site at <b>www.lgservice.com</b>.</p>
---	--

**THIS WARRANTY IS IN LIEU OF ANY OTHER WARRANTIES, EXPRESS OR IMPLIED, INCLUDING WITHOUT LIMITATION, ANY WARRANTY OF MERCHANTABILITY OR FITNESS FOR A PARTICULAR PURPOSE. TO THE EXTENT ANY IMPLIED WARRANTY IS REQUIRED BY LAW, IT IS LIMITED IN DURATION TO THE EXPRESS WARRANTY PERIOD ABOVE. LG WILL NOT BE LIABLE FOR ANY CONSEQUENTIAL, INDIRECT, OR INCIDENTAL DAMAGES OF ANY KIND, INCLUDING LOST REVENUES OR PROFITS, IN CONNECTION WITH THE PRODUCT. SOME STATES DO NOT ALLOW LIMITATION ON HOW LONG AN IMPLIED WARRANTY LASTS OR THE EXCLUSION OF INCIDENTAL OR CONSEQUENTIAL DAMAGES, SO THE ABOVE LIMITATIONS OR EXCLUSIONS MAY NOT APPLY TO YOU.**

**THIS LIMITED WARRANTY DOES NOT APPLY TO:**

1. Service calls to correct the installation of your appliance, to instruct you how to use your appliance, to replace house fuses or correct house wiring, or to replace owner-accessible light bulbs.
2. Repairs when your appliance is used in other than normal, single-family household use.
3. Pickup and delivery. Your appliance is designed to be repairable in the home.
4. Damage resulting from accident, alteration, misuse, abuse, fire, flood, improper installation, acts of God, or use of products not approved by LG Corporation.
5. Repairs to parts or systems resulting from unauthorized modifications made to the appliance.
6. Replacement parts or repair labor costs for units operated outside the United States.
7. Any labor costs during the limited warranty period.

**For USA:**

This warranty is extended to the original purchaser and any subsequent owner for products purchased for home use within the USA. In Alaska, the warranty excludes the cost of shipping or service calls to your home. Some states do not allow the exclusion or limitation of incidental or consequential damages, so this exclusion or limitation may not apply to you. This warranty gives you specific legal rights, and you may also have other rights which vary from state to state. To know what your legal rights are, consult your local or state consumer affairs or your state's Attorney General.

**For CANADA:**

This warranty is extended to the original purchaser and any succeeding owner for products purchased for home use within Canada. Some provinces do not allow the exclusion or limitation of incidental or consequential damages, so this exclusion or limitation may not apply to you. This warranty gives you specific legal rights, and you may also have other rights which vary from provinces to provinces.

**CUSTOMER ASSISTANCE INFORMATION:**

<b>For USA</b>	<b>To contact LG Electronics by mail:</b>	LG Customer Interactive Center P. O. Box 240007 201 James Record Road Huntsville, Alabama 35824 ATTN: CIC
<b>For CANADA</b>	<b>To obtain Product or Customer Service Assistance:</b>	Call 1-888-LG-CANADA (542 2623) Press the appropriate menu option, and have your product model and serial numbers and your postal code ready.
	<b>To obtain the nearest Authorized Service Center:</b>	Access our web-site at: <a href="http://ca.lge.com">http://ca.lge.com</a> (Service Option) or Call 1-888-LG-CANADA (542 2623) Press the appropriate menu option, have your product model & serial numbers & your postal code ready.

