

Panasonic

Operating Instructions

Microwave Oven
Models NN-S961
NN-S761



This manual contains Safety Instructions, Operating Instructions and Maintenance of the oven.
Before operating this oven, please read these instructions completely.
Antes de operar este producto, lea este instructivo en su totalidad.
El manual de instrucciones en español puede ser encontrada en la páginas 22-29
(Spanish Operating Instructions can be found on pages 22-29)

For assistance, please call : 1-800-211-PANA(7262)
or send e-mail to : consumerproducts@panasonic.com
or visit us at www.panasonic.com

(U.S.A.)

For assistance, please call : 787-750-4300
or visit us at www.panasonicpr.com

(Puerto Rico)

Thank you for purchasing the Panasonic Microwave Oven.

PRECAUTIONS TO AVOID POSSIBLE EXPOSURE TO EXCESSIVE MICROWAVE ENERGY

- (a) Do not attempt to operate this oven with the door open since open-door operation can result in harmful exposure to microwave energy. It is important not to defeat or tamper with the safety interlocks. Under normal conditions oven will not operate with door open.
- (b) Do not place any object between the oven front face and the door or allow soil or cleaner residue to accumulate on sealing surfaces.
- (c) Do not operate the oven if it is damaged. It is particularly important that the oven door close properly and that there is no damage to the:
 - (1) door (bent),
 - (2) hinges and latches (broken or loosened),
 - (3) door seals and sealing surfaces.
- (d) The oven should not be adjusted or repaired by anyone except properly qualified service personnel.

Technical Specifications

	NN-S961	NN-S761
Power Source:	120 V, 60 Hz	120 V, 60 Hz
Power Consumption:	11.5 Amps, 1,320 W	11.5 Amps, 1,320 W
Output*:	1,300 W	1,300 W
Outside Dimensions (H x W x D):	14" x 23 ⁷ / ₈ " x 19 ⁹ / ₁₆ " (356 x 606 x 497 mm)	11 ¹⁵ / ₁₆ " x 21 ⁷ / ₈ " x 19 ⁹ / ₁₆ " (304 x 555 x 497 mm)
Oven Cavity Dimensions (H x W x D):	10 ¹⁵ / ₁₆ " x 18 ⁷ / ₁₆ " x 18 ¹ / ₂ " (278 x 469 x 470 mm)	9" x 16 ⁷ / ₁₆ " x 18 ¹ / ₂ " (228 x 418 x 470 mm)
Operating Frequency:	2,450 MHz	2,450 MHz
Uncrated Weight:	Approx. 36 lbs. (16.4 kg)	Approx. 32 lbs. (14.3 kg)

*IEC 705-88 Test procedure

Specifications subject to change without notice.

The serial number of this product may be found on the back side of the oven. You should note the model number and the serial number of this oven in the space provided and retain this book as a permanent record of your purchase for future reference.

Model No. _____

Serial No. _____

Date of Purchase _____

CONTENTS

Before Operating

Precaution	Inside Front Cover
Important Safety Instructions	2
Installation and Grounding Instructions	3
Safety Precautions	4
Cookware and Utensil Guide	5
Feature Diagram	6
Control Panel	6

Operation & Hints

To use Function Pad	7
Clock Setting	8
To use Popcorn Pad	8
To Reheat using Power & Time Setting	8
Sensor Reheat	11
To Defrost using Power & Time Setting	8
Inverter Turbo Defrost	9 - 10
To Cook using Power & Time Setting	8
Sensor Cook	11 - 13
To use Keep Warm Pad	9
Quick Min Function	9
Timer Setting (Kitchen Timer / Stand Time / Delay Start)	14
Microwave Shortcuts	15
Food Characteristics	16
Cooking Techniques	16 - 17
Quick Guide to Operation	Back Cover

Maintenance

Technical Specifications	Inside Front Cover
Care of Your Microwave Oven	18
To order Accessories, Books, etc.	18
Before Requesting Service	19
Warranty & Service	20

Manual de instrucciones (Spanish Operating Instructions)

Precauciones	22
Instrucciones de Seguridad	23 - 24
Instrucciones para Conexión a Tierra	24
Instrucciones de Instalación	25
Sugerencias Útiles	26
Panel de Control	27
Sugerencias	27
Cómo Utilizar las Teclas de Función	28
Guía Rápida de Operación	29

IMPORTANT SAFETY INSTRUCTIONS

Your microwave oven is a cooking device and you should use as much care as you use with a stove or any other cooking device. When using this electric appliance, basic safety precautions should be followed, including the following:

WARNING—To reduce the risk of burns, electric shock, fire, injury to persons, or exposure to excessive microwave energy:

1. Read all instructions before using the appliance.
2. Read and follow the specific **"PRECAUTIONS TO AVOID POSSIBLE EXPOSURE TO EXCESSIVE MICROWAVE ENERGY,"** found on the inside front cover.
3. This appliance must be grounded. Connect only to properly grounded outlet. See **"GROUNDING INSTRUCTIONS"** found on page 3.
4. Install or locate this appliance only in accordance with the installation instructions found on page 3.
5. Do not cover or block any openings on this appliance.
6. Do not store or use this appliance outdoors. Do not use this product near water—for example, near a kitchen sink, in a wet basement, or near a swimming pool, and the like.
7. Use this appliance only for its intended use as described in this manual. **DO NOT** use corrosive chemicals, vapors, or non-food products in this appliance. This type of oven is specifically designed to heat or cook. It is not designed for industrial or laboratory use. The use of corrosive chemicals in heating or cleaning will damage the appliance and may result in radiation leaks.
8. When cleaning surfaces of door and oven that come together on closing the door, use only mild, non-abrasive soaps or detergents applied with a sponge or soft cloth.
9. Do not allow children to use this appliance, unless closely supervised by an adult.
10. Do not operate this appliance if it has a damaged cord or plug, if it is not working properly, or if it has been damaged or dropped.
11. Do not immerse cord or plug in water.
12. Keep cord away from heated surfaces.
13. Do not let cord hang over edge of a table or counter.
14. This appliance should be serviced only by qualified service personnel. Contact the nearest authorized servicenter for examination, repair or adjustment.
15. Some products such as whole eggs, narrow neck bottles and sealed containers—for example, closed glass jars—may explode and should not be heated in this oven.

16. To reduce the risk of fire in the oven cavity:
 - (a) Do not overcook food. Carefully attend appliance if paper, plastic, or other combustible materials are placed inside the oven to facilitate cooking.
 - (b) Remove wire twist-ties from paper or plastic bags before placing bag in oven.
 - (c) **If materials inside the oven should ignite, keep oven door closed, turn oven off, and disconnect the power cord, or shut off power at the fuse or circuit breaker panel.**
 - (d) Do not use the cavity for storage purposes. Do not leave paper products, cooking utensils, or food in the cavity when not in use.

General Use

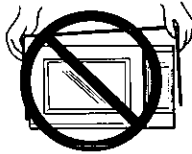
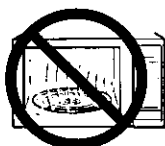
1. **DO NOT** tamper with or make any adjustments or repairs to door, Control Panel housing, safety interlock switches or any other part of the oven. **DO NOT** remove outer panel from oven. Repairs should only be done by a qualified service person. 
2. **DO NOT** operate the oven empty. The microwave energy will reflect continuously throughout the oven causing overheating, if food or water is not present to absorb energy. This could damage the oven and result in the risk of a fire. 
3. **DO NOT** dry clothes, newspapers or other materials in oven, or use newspapers or paper bags for cooking. Fire could result.
4. **DO NOT** use recycled paper products unless the paper product is labeled as safe for microwave oven use. Recycled paper products may contain impurities which may cause sparks, and result in fires when used.
5. **DO NOT** hit or strike Control Panel. Damage to controls may occur. Fire could result.
6. **POT HOLDERS** should always be used when removing items from the oven. Heat is transferred from the **HOT** food to the cooking container and from the cooking container to the Glass Tray. The Glass Tray can be very **HOT** after removing the cooking container from the oven.
7. **DO NOT** store flammable materials next to, on top of, or in the oven. These could be fire hazards.

SAVE THESE INSTRUCTIONS

For proper use of your oven read remaining safety cautions and operating instructions.

Installation and Grounding Instructions

Examine Your Oven

Unpack oven, remove all packing material and examine the oven for any damage such as dents, broken door latches or cracks in the door. Notify dealer immediately if oven is damaged. **DO NOT** install if oven is damaged.

Placement of Oven

1. Oven must be placed on a flat, stable surface. For proper operation, the oven must have sufficient air flow. Allow 3-inches (7.6 cm) of space on both sides of the oven and 1-inch (2.5 cm) of space on top of oven.

a. **DO NOT** block air vents.

If they are blocked during operation, the oven may be overheated and damaged. When using any cloth over the oven, the air intake and exhaust should not be blocked. Also should allow space on back and both sides of oven properly.

b. **DO NOT** place oven near a hot, damp surface such as a gas or electric range, or dishwasher.

c. **DO NOT** operate oven when room humidity is too high.

2. This oven was manufactured for household use only.

3. This oven may be built into a wall cabinet, if desired, by using the proper trim kit, which may be purchased from a local dealer. Follow all installation instructions packed with the kit.

Installation

1. **DO NOT** block air vents. If they are blocked during operation, the oven may overheat. If the oven overheats, a thermal safety device will turn the oven off. The oven will remain inoperable until it has cooled.

2. This oven was manufactured for household use only.

Grounding Instructions

This appliance must be grounded. In the event of an electrical short circuit, grounding reduces the risk of electric shock by providing an escape wire for the electric current. This appliance is equipped with a cord having a grounding wire with a grounding plug. The plug must be plugged into an outlet that is properly installed and grounded.

WARNING—Improper use of the grounding plug can result in a risk of electric shock.

Consult a qualified electrician or service person if the grounding instructions are not completely understood, or if doubt exists as to whether the appliance is properly grounded. If it is necessary to use an extension cord, use only a three wire extension cord that has a three blade grounding plug, and a three slot receptacle that will accept the plug on the appliance. The marked rating of the extension cord should be equal to or greater than the electrical rating of the appliance.

Power Supply

1. A short power-supply cord is provided to reduce the risks resulting from becoming entangled in or tripping over a longer cord.

2. Longer cord sets or extension cords are available and may be used if care is exercised in their use.

3. If a long cord or extension cord is used, (1) the marked electrical rating of the cord set or extension cord should be at least as great as the electrical rating of the appliance, (2) the extension cord must be

a grounding-type 3-wire cord, and (3) the longer cord should be arranged so that it will not drape over the counter top or tabletop where it can be pulled on by children or tripped over accidentally.

Wiring Requirements

1. The oven must be on a SEPARATE CIRCUIT. No other appliance should share the circuit with the microwave oven. If it does, the branch circuit fuse may blow, the circuit breaker may trip, or the food may cook slower than the times recommended in this manual.
2. The VOLTAGE used must be the same as specified on this microwave oven (120 V, 60 Hz). Using a higher voltage is dangerous and may result in a fire or other incident causing oven damage. Using a lower voltage will cause slow cooking. Panasonic is **NOT** responsible for damage resulting from the use of the oven with other than the specified voltage.
3. The oven must be plugged into at least a 20 AMP, 120 VOLT, 60 Hz GROUNDED OUTLET. Where a standard two-prong outlet is encountered, it is the personal responsibility and obligation of the consumer to have it replaced with a properly grounded three-prong outlet.



TV / Radio Interference

1. Operation of the microwave oven may cause interference to your radio, TV or similar equipment.
2. When there is interference, it may be reduced or eliminated by taking the following measures:
 - a. Clean door and sealing surfaces of the oven. (See Care of Your Microwave Oven)
 - b. Place the radio, TV, etc. away from the microwave oven as far as possible.
 - c. Use a properly installed antenna to obtain stronger signal reception.

Glass Tray

1. **DO NOT** operate the oven without Roller Ring and Glass Tray in place.
2. **DO NOT** operate the oven without the Glass Tray fully engaged on the drive hub. Improper cooking or damage to the oven could result. Verify that the Glass Tray is properly engaged and rotating by observing its rotation when you press **Start**.
3. Only use the Glass Tray specifically designed for this oven. Do not substitute any other glass tray.
4. If the Glass Tray is hot, allow to cool before cleaning or placing in water.
5. **DO NOT** cook directly on the Glass Tray. Always place food in a microwave-safe dish, or on a rack set in a microwave-safe dish.
6. If food or utensil on the Glass Tray touches oven walls, causing the tray to stop moving, the tray will automatically rotate in the opposite direction. This is normal.
7. Glass Tray can turn in either direction.

Roller Ring

1. Roller Ring and oven floor should be cleaned frequently to prevent excessive noise.
2. Roller Ring must always be used for cooking along with Glass Tray.
3. Always replace Roller Ring and Glass Tray in their proper positions.

Safety Precautions

Follow These Safety Precautions When Cooking in Your Oven

IMPORTANT

Proper cooking depends upon the power, the time set and quantity of food. If you use a smaller portion than recommended and cook at the time for the recommended portion, fire can result.

1) HOME CANNING / DRYING FOODS / SMALL QUANTITIES OF FOODS

- Do not use your oven for home canning, your oven cannot maintain the food at the proper canning temperature. Improperly canned food may spoil and be dangerous to consume.
- Do not dry meats, herbs, fruits or vegetables in your oven. Small quantities of food or foods with low moisture content can dry out, scorch or catch on fire if overheated.

2) POPCORN

Popcorn may be popped in a microwave oven corn popper. Microwave popcorn which pops in its own package is also available. Follow popcorn manufacturers' directions and use a brand suitable for the wattage of your microwave oven.

CAUTION: When using pre-packaged microwave popcorn, follow recommended package instructions. Check package weight before using the *Popcorn* pad (see *Popcorn* Pad section). Set the oven for the weight of the popcorn package.

If these instructions are not followed, the popcorn may not pop adequately or may ignite and cause a fire. Never leave oven unattended when popping popcorn. Allow the popcorn bag to cool before opening, always open the bag away from your face and body to prevent steam.

3) DEEP FAT FRYING

- Do not attempt to deep fat fry in your microwave oven. Cooking oils may burst into flames and may cause damage to the oven and perhaps result in burns. Microwave utensils may not be able to withstand the temperature of the hot oil, and could shatter or melt.

4) FOODS WITH NONPOROUS SKINS

- Potatoes, apples, egg yolks, whole eggs, whole squash and sausages are examples of foods with nonporous skins. These types of foods must be pierced before microwave cooking to prevent their bursting.
- Use fresh potatoes for baking and cook until just done. Use recommended weights for programmed cooking. Overcooking causes dehydration and may result in a fire.

5) LIQUIDS

- Liquids can become "superheated" in a microwave, and when the container is moved in any way, the superheated liquids can "explode" out of the container. "Superheated" water is hotter than boiling water, EVEN THOUGH IT DOES NOT APPEAR TO BUBBLE. To reduce the possibility of this occurrence:

Always make sure that liquids are stirred vigorously before heating to assure that the liquid is mixed with air. **NEVER HEAT LIQUIDS FOR AN EXCESSIVE LENGTH OF TIME.**

6) GLASS TRAY / COOKING UTENSILS / FOIL

- Cooking utensils get hot during microwaving. Heat is transferred from the HOT food to the container and the Glass Tray. Use potholders when removing utensils from the oven or when removing lids or plastic wrap covers from cooking utensils to avoid burns.
- The Glass Tray will get hot during cooking. It should be allowed to cool before handling or before paper products, such as paper plates or microwave popcorn bags, are placed in the oven for microwave cooking.
- When using foil, skewers, warming rack or utensils made of metal in the oven, allow at least 1-inch (2.5 cm) of space between metal material and interior oven walls. If arcing occurs (sparkling), remove metal material (skewers etc.) and/or transfer to a non-metallic container.
- Dishes with metallic trim should not be used, as arcing may occur.
- If an entree is heated in a foil tray, maintain at least 1-inch (2.5 cm) spacing from the oven walls.

7) PAPER TOWELS / CLOTHS

- DO NOT use paper towels or cloths which contain a synthetic fiber woven into them. The synthetic fiber may cause the towel to ignite. Use paper toweling under supervision.

8) BROWNING DISHES / OVEN COOKING BAGS

- Browning dishes or grills are designed for microwave cooking only. Always follow instructions provided by the manufacturer. DO NOT pre-heat browning dish more than 6 minutes.
- If an oven cooking bag is used for microwave cooking, prepare according to package directions. DO NOT use a wire twist-tie to close bag, instead use plastic ties, cotton string or a strip cut from the open end of the bag.

9) THERMOMETERS

- DO NOT use a conventional meat thermometer in your oven. Arcing may occur. Microwave-safe thermometers are available for both meat and candy.

10) BABY FORMULA / FOOD

- DO NOT heat baby formula or food in the microwave oven. The glass jar or surface of the food may appear warm while the interior can be so hot as to burn the infant's mouth and esophagus.

11) REHEATING PASTRY PRODUCTS

- When reheating pastry products, check temperatures of any fillings before eating. Some foods have fillings which heat faster and can be extremely hot, while the surface remains warm to the touch (ex. Jelly Donuts).

12) GENERAL OVEN USAGE GUIDELINES

- DO NOT use the oven for any reason other than the preparation of food.
- DO NOT leave oven unattended while in use.

Cookware and Utensil Guide

ITEM	MICROWAVE	COMMENTS
Aluminum Foil	Yes for Shielding only	Small strips of foil can be molded around thin parts of meat or poultry to prevent overcooking. Arcing can occur if foil is too close to oven wall or if too much foil is used.
Browning Dish	Yes	Browning dishes are designed for microwave cooking only. Check browning dish information for instructions and heating chart. Do not preheat for more than 6 minutes.
Brown paper bags	No	May cause a fire in the oven.
Dinnerware Labeled "Microwave-Safe"	Yes	Check manufacturers' use and care directions for use in microwave heating. Some dinnerware may state on the back of the dish, "Oven-Microwave Safe".
Other Dinnerware	?	Use CONTAINER TEST below.
Disposable polyester Paperboard Dishes	Yes	Some frozen foods are packaged in these dishes. Can be purchased in grocery stores.
Fast Food Carton with Metal Handle	No	Metal handle may cause arcing.
Frozen Dinner Tray Metal	Yes	Frozen dinners may be heated in foil tray, if tray is less than ¾-in. (2 cm) high. Place foil tray in center of oven. Leave at least 1-in. (2.5 cm) space between foil tray and oven walls. Heat only 1 foil tray in the oven at a time. For containers more than ¾-inch (2 cm) deep, remove food and place in a similar size microwave-safe container.
Microwave-safe	Yes	
Glass Jars	Yes, use caution	Remove lid. Heat food until just warm, not HOT. Most glass jars are not heat resistant. Do not use for cooking.
Glassware Heat Resistant Oven Glassware & Ceramics	Yes	Ideal for microwave cooking and browning. (See CONTAINER TEST below)
Metal Bakeware	No	Not recommended for use in microwave ovens.
Metal Twist-Ties	No	May cause arcing which could cause a fire in the oven.
Oven Cooking Bag	Yes	Follow manufacturers' directions. Close bag with the nylon tie provided, a strip cut from the end of the bag, or a piece of cotton string. Do not close with metal twist-tie. Make six ½-inch (1 cm) slits near the closure.
Paper Plates & Cups	Yes	Use to warm cooked foods, and to cook foods that require short cooking times such as hot dogs.
Paper Towels & Napkins	Yes	Use to warm rolls and sandwiches by microwave.
Parchment Paper	Yes	Use as a cover to prevent spattering. Safe for use in microwave, microwave/convection and conventional ovens.
Plastic Microwave-Safe Cookware Reheat & Storage	Yes	Should be labeled, "Suitable for Microwave Heating." Check manufacturers' directions for recommended uses. Some microwave-safe plastic dishes are not suitable for cooking foods with high fat or sugar content. The heat from hot food may cause the plastic to warp.
Melamine	No	
Plastic Foam Cups	Yes, use caution	Plastic foam will melt if foods reach a high temperature. Use to bring foods to a low serving temperature.
Plastic Wrap	Yes	Use to cover food during cooking to retain moisture and prevent spattering. Should be labeled "Suitable for Microwave Heating". Check package directions.
Straw, Wicker, Wood	Yes	Use only for short term reheating and to bring food to a low serving temperature.
Thermometers Microwave-safe, only	Yes	Use only microwave-safe meat and candy thermometers. Not suitable for use in microwave oven, will cause sparks and get hot.
Conventional	No	
Wax paper	Yes	Use as a cover to prevent spattering and to retain moisture.

CONTAINER TEST

TO TEST A CONTAINER FOR SAFE MICROWAVE OVEN USE: Fill a 1-cup glass measure with water and place it in the microwave oven along with the container to be tested; **heat one (1) minute at P10 (HIGH)**. If the container is microwave oven-safe (transparent to microwave energy), the container should remain comfortably cool and the water should be hot. If the container is hot, it has absorbed some microwave energy and should NOT be used. This test cannot be used for plastic containers.

Feature Diagram

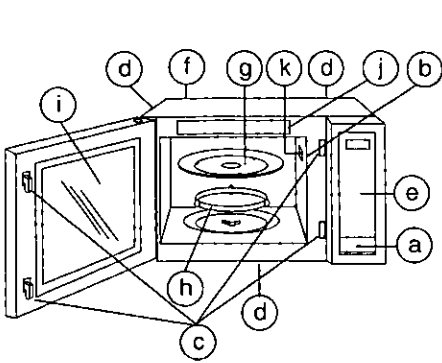

- (a) Door Release Button
- (b) Internal Air Vents
- (c) Door Safety Lock System
- (d) External Air Vents
- (e) Control Panel
- (f) Identification Plate
- (g) Glass Tray
- (h) Roller Ring
- (i) Heat/Vapor Barrier Film
(do not remove)
- (j) Menu Label
- (k) Cover (do not remove)

Control Panel

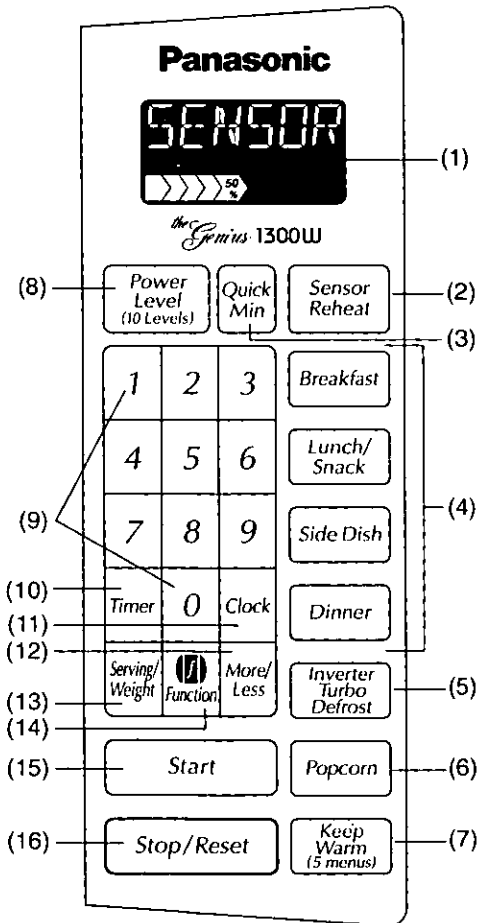

- (1) **Display Window**
- (2) **Sensor Reheat Pad** (☛ page 11)
- (3) **Quick Min Pad** (☛ page 9)
- (4) **Sensor Cook Pads**
(☛ page 11)
- (5) **Inverter Turbo Defrost Pad**
(☛ page 9)
- (6) **Popcorn Pad** (☛ page 8)
- (7) **Keep Warm Pad** (☛ page 9)
- (8) **Power Level Pad** (☛ page 8)
- (9) **Number Pads**
- (10) **Timer Pad** (☛ page 14)
- (11) **Clock Pad** (☛ pages 8)
- (12) **More/Less Pad** (☛ page 11)
- (13) **Serving/Weight Pad** (☛ page 9)
- (14) **Function Pad** (☛ page 7)
- (15) **Start Pad**

One tap allows oven to begin functioning. If door is opened or **Stop/Reset Pad** is pressed once during oven operation, **Start Pad** must be pressed again to restart oven.

- (16) **Stop/Reset Pad**
Before cooking: One tap clears your instruction.
During cooking: One tap temporarily stops the cooking process. Another tap cancels all your instructions and time of day or color appears on the **Display Window**.

Beep Sound:

When a pad is pressed correctly, a beep will be heard. If a pad is pressed and no beep is heard, the unit did not or cannot accept the instruction. The oven will beep twice between programmed stages. At the end of any complete program, the oven will beep 5 times.

To Use Function Pad

This unique feature of your PANASONIC microwave oven allows you to establish the initial non-cooking features of your oven such as CHILD LOCK, WORD SPEED, LANGUAGE CHOICE (ENGLISH, FRENCH OR SPANISH), plus many more. See below.

1)		Press: FUNCTION. Menu Action Message is "Select Function 0 through 9, 1--LANGUAGE CHOICE --- etc".
2)	Select a number (0-9) Ex. CHILD LOCK is 5	Press 5: Menu Action Message is "CHILD LOCK ON/OFF".
3)	Select 1 , 2 or 3	Press: One number. Your selection is now part of the operating system. You can change it any time.
4)	Continue until you have completed your selections.	See below for other options.





→	1	LANGUAGE CHOICE The oven has English, French and Spanish display. The display appears in English when you plug-in. 1 ENGLISH ↔ Display appears in English. 2 FRANCAIS ↔ Display appears in French. 3 ESPANOL ↔ Display appears in Spanish.
→	2	Lb/KG CHOICE The oven has both imperial and metric weight measurements. The oven displays the weight in imperial when you plug it in. 1 Lb ↔ Weight can be set in oz/lb, (Imperial). 2 KG ↔ Weight can be set in g/kg, (Metric).
→	3	WORD SPEED The speed of word scrolling in the <i>Display Window</i> can be sped up or slowed down. 1 QUICK ↔ Words scroll quickly. 2 MEDIUM ↔ Scrolling speed returns to initial setting. 3 SLOW ↔ Words scroll slowly.
→	4	MENU ACTION ON/OFF MENU ACTION SCREEN helps you to program your oven by prompting the next step to be taken. When you become familiar with your oven, the prompting can be turned off. 1 ON ↔ Prompting Guide will appear. 2 OFF ↔ Prompting Guide will not appear.
→	5	CHILD LOCK ON/OFF The oven has Child Safety Lock feature which prevents use by children. It does not lock the door. 1 ON ↔ Child Lock has been set and operation will not be accepted. 2 OFF ↔ Child Lock has been cancelled.
→	6	BEEP ON/OFF If you wish to have the oven operate with no beep, it can be eliminated. 1 ON ↔ Beep sound will reactivate. 2 OFF ↔ Beep sound will not be heard.
→	7	REMINDER BEEP ON/OFF A reminder beep works to remind you to remove the food from the oven after the completion of cooking. It will occur every 15 seconds. 1 ON ↔ Reminder beep will work. 2 OFF ↔ Reminder beep will not work.
→	8	DAYLIGHT SAVING ON/OFF 1 ON ↔ Time of day will advance one hour. 2 OFF ↔ Time of day returns to original setting.
→	9	CLOCK ON/OFF Clock display can be turned off. 1 ON ↔ Clock display will appear in the <i>Display Window</i> . 2 OFF ↔ Clock display will not appear in the <i>Display Window</i> . Time of day will not be lost while the display is off.
→	0	DEMO MODE ON/OFF Demo mode is designed for retail store display. In this mode, the oven can be demonstrated with no power in the oven. 1 ON ↔ The oven is in Demo mode. 2 OFF ↔ The oven is not in Demo mode.

Clock Setting

The oven will operate without setting the clock.

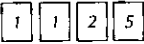
Example: To set 11:25 a.m. or p.m.

1.		<ul style="list-style-type: none"> Press once. ➤ Colon flashes.
2.		<ul style="list-style-type: none"> Enter time of day using the number pads. ➤ Time appears on the <i>Display Window</i>; colon is continues flashing.
3.		<ul style="list-style-type: none"> Press. ➤ Colon stops flashing; time of day is entered.

NOTES:

- To reset the clock, repeat steps 1-3.
- The clock will retain the time of day as long as the oven is plugged in and electricity is supplied.
- Clock is a 12 hour display.
- Oven will not operate while colon is flashing.

To Use Popcorn Pad

Example: To heat 3.5 oz. of Popcorn

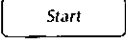
1.		<ul style="list-style-type: none"> Set the desired weight of prepackaged microwave popcorn. <table border="1" data-bbox="246 842 495 976"> <thead> <tr> <th>Press</th> <th>Weight</th> </tr> </thead> <tbody> <tr> <td>once</td> <td>1.75 oz. (50g)</td> </tr> <tr> <td>twice</td> <td>2.65 oz. (75g)</td> </tr> <tr> <td>3 times</td> <td>2.85 oz. (80g)</td> </tr> <tr> <td>4 times</td> <td>3.0 oz. (85g)</td> </tr> <tr> <td>5 times</td> <td>3.5 oz. (99g)</td> </tr> </tbody> </table>	Press	Weight	once	1.75 oz. (50g)	twice	2.65 oz. (75g)	3 times	2.85 oz. (80g)	4 times	3.0 oz. (85g)	5 times	3.5 oz. (99g)
Press	Weight													
once	1.75 oz. (50g)													
twice	2.65 oz. (75g)													
3 times	2.85 oz. (80g)													
4 times	3.0 oz. (85g)													
5 times	3.5 oz. (99g)													
2.		<ul style="list-style-type: none"> Press Start Pad. ➤ Cooking time appears in the <i>Display Window</i> and begins to count down. 												

NOTES ON POPCORN PAD:

- Use prepackaged **room temperature** microwave popcorn. Read manufacturers' instructions.
- Place bag in oven according to manufacturers' directions.
- Pop only **one** bag at a time.
- After popping, allow the contents of the bag to cool for a few minutes before opening. Open bag carefully away from face and body because popcorn and steam are extremely hot.
- Do not reheat unpopped kernels or reuse bag.
- NEVER** leave oven unattended when popping popcorn. Stop the oven when popping slows to 2 to 3 seconds between pops. Overcooking may cause scorching.
- With the many varieties of microwave popcorn available in the market place, it may be necessary for you to move the popcorn container to the outer edge of the Glass Tray to obtain the best cooking results.

Power & Time Setting

How do I program Power and Time?

Example: To cook at P 6 (MEDIUM) Power for 1 minute 30 seconds

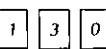
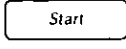
1.		<ul style="list-style-type: none"> Select Power Level. (according to the chart below)
	Press 5 times.	
2.		<ul style="list-style-type: none"> Set Cooking Time using number pads.
3.		<ul style="list-style-type: none"> Press. ➤ Cooking will start. The time on the <i>Display Window</i> will count down.

Press	Power Level
once	P10 (HIGH)
twice	P 9
3 times	P 8
4 times	P 7 (MEDIUM-HIGH)
5 times	P 6 (MEDIUM)
6 times	P 5
7 times	P 4
8 times	P 3 (MEDIUM-LOW)/DEFROST
9 times	P 2
10 times	P 1 (LOW)

NOTES:

- For more than one stage cooking, repeat steps 1 and 2 for each stage of cooking before pressing **Start** Pad. Maximum number of stages for cooking is 5 stages.
- When selecting P10 (HIGH) power for the first stage, you may begin at step 2.
- Two beeps will sound between each stage of programming. Five beeps will sound at the end of the entire sequence.
- When selecting P10 (HIGH) power, the maximum programmable time is 30 minutes. For other power levels, the maximum time is 99 minutes and 99 seconds.
- For reheating, use P10 (HIGH) for liquids, P7 (MEDIUM-HIGH) for most foods and P6 (MEDIUM) for dense foods.
- For defrosting, use P3 (MEDIUM-LOW).

REMARKS:

When popping multiple bags one right after the other, the cooking times may vary slightly. This does not affect the popcorn results.



CAUTION:

If pre-packaged popcorn is of a different weight than the recommended weight, do not use the preset popcorn settings. Set Power Level and time according to the manufacturer's instructions.

To Use Keep Warm Pad

This feature helps you to keep a certain selection of foods warm for 30 minutes after cooking. (Pie, Gravy, Stew, Casserole or Mashed Potatoes)

Example: To keep 2 cups of Gravy warm.

<p>1. </p> <p>Press twice.</p>	<ul style="list-style-type: none"> Select the desired category.
<p>2. </p> <p>Press twice.</p>	<ul style="list-style-type: none"> Verify serving size (1-4) in the Display Window.
<p>3. </p>	<ul style="list-style-type: none"> Press. <ul style="list-style-type: none"> Keep warm will start. The time on the Display Window will count down from 30 minutes.

Quick Min Function

This feature allows you to set and/or add cooking times easily in multiples of one minute.

To Set Cooking Time:

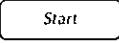
<p>1. </p>	<ul style="list-style-type: none"> Set cooking time (up to 10) Power Level is P10.
<p>2. </p>	<ul style="list-style-type: none"> Press Start Pad. <ul style="list-style-type: none"> Cooking begins and Display Window counts down. At the end of cooking, 5 beeps sound and colon or time of day appears.



NOTE:

- You can use other power levels, select desired power level before setting cooking time.
- After setting the time by **Quick Min** Pad, you cannot use Number Pads, and vice versa.
- Press **Quick Min** Pad to add more time during cooking. To verify the additional cooking time, check the **Display Window**.

Inverter Turbo Defrost

This feature allows you to defrost meat, poultry and seafood simply by entering the weight.

Example: To defrost 1.5 pounds of meat.

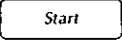
<p>1. </p>	<ul style="list-style-type: none"> Press. "def" appears briefly in the Display Window.
<p>2. </p>	<ul style="list-style-type: none"> Enter weight of the food using the number pads.
<p>3. </p>	<ul style="list-style-type: none"> Press. <ul style="list-style-type: none"> Defrosting will start. The time on the Display Window will count down.

NOTE:

Time will vary depending on size and wattage of your oven.

Conversion Chart:

Follow the chart to convert ounces or hundredths of a pound into tenths of a pound. To use Auto Defrost, program the weight of the food in lbs. (1.0) and tenths of a lb. (0.1). If a piece of meat weighs 1.95 lbs. or 1 lb. 14 oz., program 1.9 lbs.

Ounces	Hundredths of a Pound	Tenths of a Pound
0	.01 - .05	0.0
1 - 2	.06 - .15	0.1
3 - 4	.16 - .25	0.2
5	.26 - .35	0.3
6 - 7	.36 - .45	0.4
8	.46 - .55	0.5
9 - 10	.56 - .65	0.6
11 - 12	.66 - .75	0.7
13	.76 - .85	0.8
14 - 15	.86 - .95	0.9

Defrosting Tips & Techniques

Before Freezing:

1. Freeze meats, poultry and fish in packages with only 1 or 2 layers of food. Place wax paper between layers.
2. Package in heavy-duty plastic wraps, bags (labeled "For Freezer") or freezer paper.
3. Remove as much air as possible, i.e. create a vacuum.
4. Seal securely, date and label.

To Defrost:

1. Remove wrapper. This helps moisture to evaporate. Juices from food can get hot and cook the food.
2. Set food on microwave safe roasting rack in an appropriately sized dish.
3. Place roasts fat-side down. Place whole poultry breast-side down.
4. Drain liquids during defrosting.
5. Turn over (invert) items during defrosting.
6. Shield edges and ends if needed. (See **Cooking Techniques**).
7. Select power and minimum time so that items will be under-defrosted.

After Defrosting:



1. Large items may be icy in the center. Defrosting will complete during STANDING TIME.
2. Let stand, covered with plastic wrap, in the refrigerator for time shown in the chart below.
3. See chart below for standing time and rinsing directions.
4. Items which have been layered should be rinsed separately or have a longer stand time.

FOOD	DEFROST TIME at P3 (min./lb.)	DURING DEFROSTING	AFTER DEFROSTING	
			Stand Time	Rinse
Fish and Seafood [up to 3 lbs. (1.4 kg)]				
Crabmeat	6	Break apart/Rearrange	5 min.	YES
Fish Steaks	4 to 6	Turn over		
Fish Fillets	4 to 6	Turn over/Rearrange/Shield ends		
Sea Scallops	4 to 6	Break apart/Remove defrosted pieces		
Whole fish	4 to 6	Turn over		
Meat				
Ground Meat	4 to 5	Turn over/Remove defrosted portion/ Shield edges	10 min.	NO
Roasts [2½-4 lbs. (1.1-1.8 kg)]	4 to 8	Turn over/Shield ends and defrosted surface	30 min. in refrig.	
Chops/Steak	6 to 8	Turn over/Rearrange/Shield ends and defrosted surface	5 min.	
Ribs/T-bone	6 to 8	Turn over/Rearrange/Shield ends and defrosted surface		
Stew Meat	4 to 8	Break apart/Rearrange/ Remove defrosted pieces		
Liver (thin sliced)	4 to 6	Drain liquid/Turn over/ Separate pieces		
Bacon (sliced)	4	Turn over		
Poultry				
Chicken, Whole [up to 3 lbs. (1.4 kg)]	4 to 6	Turn over/Shield	20 min. in refrig.	YES
Cutlets	4 to 6	Break apart/Turn over/ Remove defrosted Pieces	5 min.	
Pieces	4 to 6	Break apart/Turn over/Shield	10 min.	
Cornish Hens	6 to 8	Turn over/Shield	20 min. in refrig.	
Turkey Breast [5-6 lbs. (2.3-2.7 kg)]	6	Turn over/Shield		

Sensor Reheat

This sensor feature allows you to reheat any quantity of food with only one touch. The oven does it all for you.

Example: To reheat 2 cups of soup

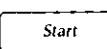
1.		• Press.
2.	 Optional*	
3.		• Press. ▶Cooking starts.
<p>After heat/steam is detected by the Genius, 2 beeps sound. The remaining cooking time appears on the Display Window and begins to count down. At the end of cooking, five beeps sound.</p>		

NOTES:

Casseroles - Add 3 to 4 tablespoons of liquid; cover with lid or vented plastic wrap. Stir when time appears in the **Display Window**.

Canned foods - Empty contents into casserole dish or serving bowl; cover dish with lid or vented plastic wrap. After reheating, release plastic wrap and stand.

Plate of food - Arrange food on plate; top with butter, gravy, etc.. After reheating, release plastic wrap and stand.

Follow the recommendations for Sensor Cooking, in addition to the following:

DO NOT:

1. Reheat bread and pastry products. Use manual power and time for these foods.
2. Reheat raw or uncooked food.
3. Use if oven cavity is warm.
4. Use for beverages.
5. Use for frozen foods.

For the best results with the GENIUS, follow these recommendations.

BEFORE Reheating/Cooking



1. The room temperature surrounding the oven should be below 95° F (35° C).
2. Food weight should exceed 4 oz. (110 g).
3. Glass Tray and outside of container should be dry.
4. Cover food loosely with lid, or vented plastic wrap.
5. All foods should be taken from their normal storage place.

Sensor Cook

Breakfast
Lunch/Snack
Side Dish
Dinner

This sensor feature allows you to cook any quantity of food with only one touch. The oven does it all for you.

Example: To cook a 10 oz. Frozen Entrée.

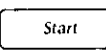
1.	 Press twice.	• Press until the desired category appears in the Display Window .
2.	 Optional*	
3.		• Press. ▶Cooking starts.
<p>After heat/steam is detected by the Genius, 2 beeps sound. The remaining cooking time appears on the Display Window and begins to count down. At the end of cooking, five beeps sound.</p>		

*More/Less Pad

Preferences for food doneness vary with each individual. After having used the Sensor Cook feature a few times, you may decide you would prefer your food cooked to a different doneness. By using the **More/Less** pad, the programs can be adjusted to cook food for a longer or shorter time.

- 1 tap=**More** cooking
- 2 taps=**Less** cooking
- 3 taps=original setting

Press **More/Less** before pressing **Start**.

DURING Reheating/Cooking:

DO NOT open the oven door until 2 beeps sound and time appears in the **Display Window**. Doing so will cause inaccurate cooking since the steam from food is no longer contained within the oven cavity. Once the timer begins to count down, the oven door may be opened to stir, turn, shield, rearrange, mix or add foods.

AFTER Reheating/Cooking:

All foods should have a covered stand time.

Sensor Cook Chart

Pad	Recipe	Serving/Weight	HINTS
Breakfast	Oatmeal	½, 1 cup	Place inside a microwave-safe serving bowl with no cover. Follow manufacturers' directions for preparation of quick oatmeal.
	Breakfast Sausage	8 maximum	Follow manufacturers' directions for preparation of pre-cooked breakfast sausage. Place in a radial pattern.
	Omelet	2, 4 eggs	Follow Basic Omelet recipe on page 13.
Lunch /Snack	Soup	1 - 2 cups	Pour soup into a microwave-safe serving bowl. Cover loosely with lid or vented plastic wrap.
	Frozen Entrées	8 - 32 oz.	Follow manufacturers' directions for preparation of 8 and 10 oz. sizes. For larger sized entrées, where the directions state for the entire film cover to be removed, do not vent or remove film cover to ensure the sensor will detect accurately for complete cooking. Be careful when removing the film cover after cooking. Remove them away from you to avoid steam burns. If additional time is needed, continue to cook manually.
	Frozen Pizza	4, 8 oz.	Follow manufacturers' directions for preparation.
	Hot Dog	4 maximum	Make 3 slits on each Hot Dog. Place Hot Dog on paper plate or microwave-safe dish leaving space between each. Times may vary by size and manufacturer.
Side Dish	Potatoes	4 maximum (6-8 oz. each)	Pierce at least 6 times on top of the potato with a fork. Place potatoes on potato a microwave-safe dish. Do not cover. Let stand 5 minutes to complete cooking.
	Rice	½ - 1½ cups	Place rice with hot water in a microwave-safe casserole dish. Cover loosely with lid or vented plastic wrap. Let stand 5 to 10 minutes before serving.
	Fresh Vegetables	¼ - 1 lb.	All pieces should be the same size. Add a small amount of water and cover loosely with lid or vented plastic wrap.
	Canned Vegetables	15 oz.	Empty contents into microwave-safe serving bowl. Cover loosely with lid or vented plastic wrap.
	Frozen Vegetables	6-16 oz.	Follow manufacturers' directions. Do not salt until after cooking. (Not suitable for vegetables in butter or sauce.) After 2 beeps, stir or rearrange.
Dinner	Frozen Dinners	11,15 oz.	Follow manufacturers' directions for covering or removing covers. For best results, do not use frozen foods packaged in foil tray.
	Chicken Pieces	½ - 2 lb.	Place skin-side up. Cover with vented plastic wrap. Let stand 5 minutes before serving.
	Ground Meat	1 - 2 lb. (16-32 oz.)	Break apart in glass bowl or colander. Cover with vented plastic wrap. After 2 beeps, stir. Re-cover and press Start . Juices should be clear. Drain.
	Fish Fillets	¼ - 1 lb.	Arrange in a single layer. Cover with vented plastic wrap.
	Pasta	2 - 8 oz.	Place pasta with hot water in a microwave-safe casserole dish. Cover loosely with lid or plastic wrap. Drain.
	Casserole	-----	Prepare according to recipes found on page 13.

Sensor Cook Recipe

OMELET

Basic Omelet

- 1 tablespoon butter or margarine
- 2 eggs
- 2 tablespoons milk
- salt and ground black pepper, if desired

Heat butter in a 9-inch pie plate, 30 seconds at P10, or until melted, turn the plate to coat the bottom with butter.

Meanwhile, combine the remaining ingredients; pour into the pie plate. Cook, covered with vented plastic wrap, on OMELET. Let stand 2 minutes. With a spatula, loosen the edges of the omelet from the plate; fold into thirds to serve.

Yield: 1 serving

Approx. cooking time: 4 minutes.

NOTE: Double ingredients for a 4 egg Omelet.

CASSEROLE

Shepherd's Pie

- 1 pound lean ground beef
- $\frac{1}{2}$ cup frozen peas, thawed
- $\frac{1}{4}$ cup chopped onion
- 1 tablespoon gravy powder
- $\frac{1}{2}$ teaspoon curry powder
- $\frac{1}{4}$ teaspoon salt
- $\frac{1}{4}$ teaspoon ground black pepper
- 2 cups mashed potatoes

In a 2-Qt. casserole dish, crumble the beef and cook for 5-7 minutes at P6, until the meat is cooked; stirring twice. Add the remaining ingredients, except the potatoes. Stir well and spread the potatoes evenly on the top. Cover with a lid and cook on CASSEROLE.

Yield: 4 servings

Approx. cooking time: 20minutes

Macaroni and Cheese

- $\frac{1}{4}$ cup butter
- 2 tablespoons chopped onion
- 1 clove minced garlic
- $\frac{1}{4}$ cup all-purpose flour
- 1 teaspoon dry mustard
- 1 teaspoon salt
- $\frac{1}{4}$ teaspoon ground black pepper
- 2 cups milk
- 2 cups grated cheddar cheese
- 8 oz. ($\frac{1}{2}$ lb) macaroni, cooked and drained
- $\frac{1}{3}$ cup bread crumbs
- 1 teaspoon paprika

In a 1-Qt. casserole, melt the butter for 40 seconds at P10. Add onion and garlic and cook for 1 minute at P10. Stir in flour, mustard, salt and pepper then, gradually add the milk. Cook for 3-4 minutes at P10, stirring once. Continue cooking for 3-4 minutes at P10 or until sauce thickens. Stir in the cheddar cheese. Stir the sauce into the macaroni, in a 2-Qt. casserole. Top with bread crumbs and paprika. Cover with vented plastic wrap. Cook on CASSEROLE.

Yield: 6 servings

Approx. cooking time: 20minutes

Beef and Macaroni Casserole

- 1 pound lean ground beef
- 1 small chopped onion
- $\frac{1}{2}$ green bell pepper, chopped
- 1 cup chopped celery
- 2 cans (15 oz.) tomato sauce
- $\frac{1}{4}$ cups water
- 1 cup uncooked elbow macaroni
- 1 teaspoon parsley
- $\frac{1}{2}$ teaspoon salt
- $\frac{1}{4}$ teaspoon ground black pepper
- $\frac{1}{2}$ cup grated cheddar cheese

Crumble the ground beef in a 3-Qt. casserole. Cook for 5 - 7 minutes at P6 or until the meat is cooked; stirring twice. Add onion, peppers and celery. Cook for 3-4 minutes at P10. Add the remaining ingredients, except cheese. Cover with vented plastic wrap. Cook on CASSEROLE. Sprinkle with cheese. Cover and let stand 5 minutes.

Yield: 4-6 servings

Approx. cooking time: 20minutes

Tuna Casserole

- 1 can (6 oz.) drained and flaked tuna
- 4 cups cooked and drained noodles
- 1 can (10 $\frac{3}{4}$ oz.) condensed cream of mushroom soup
- 1 can (4 oz.) mushroom pieces and stems, drained
- 1 package (16 oz.) frozen peas, defrosted
- $\frac{3}{4}$ cup milk
- 1 cup crushed potato chips
- $\frac{1}{2}$ cup grated cheddar cheese

In a 3-Qt. casserole, combine tuna, noodles, soup, mushrooms, peas and milk; mix well. Cover with vented plastic wrap. Cook on CASSEROLE. Top with potato chips and cheese.

Yield: 4-6 servings



Approx. cooking time: 20minutes

Timer Setting

This feature allows you to program a Standing Time after cooking is completed and to program the oven as a kitchen timer and/or to program a delay start.





To Use as a Kitchen Timer:

Example: To count 5 minutes

1.		• Press.
2.		• Set desired amount of time using number pads. (up to 99 minutes and 99 seconds).
3.		• Press. ▶ Time will count down without oven operating.



To Set Stand Time:

Example: To stand for 5 mins. after cooking (3 mins. at P6-MEDIUM Power)

1.	 4 times ▼ 	• Enter the desired cooking program (see page 8 for directions).
2.		• Press.
3.		• Set desired amount of Stand Time using number pads. (up to 99 minutes and 99 seconds)
4.		• Press. ▶ Cooking will start. After cooking, stand time will count down without oven operating.

To Set Delay Start:

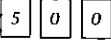
Example: To start cooking 5 minutes later. (3 mins. at P6-MEDIUM Power).

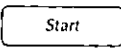
1.		• Press.
2.		• Enter desired amount of delayed time using number pads. (up to 99 minutes and 99 seconds)
3.	 ▼ 	• Enter the desired cooking program (see page 8 for directions).
4.		• Press. ▶ Delayed time will count down. Then cooking will start.

NOTES:

1. When each stage finishes, a two beep signal sounds. At the end of the program, the oven will beep five times.
2. If oven door is opened during Stand Time or Kitchen Timer, the time on the **Display Window** will continue to count down.
3. Stand time and Delay time cannot be programmed before any Auto Control Function. This is to prevent the starting temperature of food from rising before defrosting or cooking begins. A change in starting temperature could cause inaccurate results.

Microwave Shortcuts

FOOD	POWER	TIME (in mins.)	DIRECTIONS
To separate Bacon , 1 pound (450 g)	P10 (High)	30 sec.	Remove wrapper and place in microwave-safe dish. After heating, use a plastic spatula to separate slices.
To soften Brown Sugar 1 cup (250 mL)	P10 (High)	20 - 30 sec.	Place brown sugar in microwave-safe dish with a slice of bread. Cover with plastic wrap.
To soften Butter , 1 stick, ¼ pound (110 g)	P3 (MED-LOW)	1	Remove wrapper and place butter in a microwave-safe dish.
To melt Butter , 1 stick, ¼ pound (110 g)	P6 (MEDIUM)	1½ - 2	Remove wrapper and place butter in a microwave-safe dish covered with plastic wrap.
To melt Chocolate , 1 square, 1 oz. (28 g)	P10 (High)	1 - 1½	Remove wrapper and place chocolate in a microwave-safe dish. Stir before adding more time. (Stir until completely melted.) <i>Note: Chocolate holds its shape even when softened.</i>
To melt Chocolate , ½ cup (125 mL) chips	P10 (High)	1 - 1½	
To toast Coconut , ½ cup (125 mL)	P10 (High)	1	Place in a microwave-safe dish. Stir every 30 seconds.
To soften Cream Cheese , 8 oz. (250 g)	P3 (MED-LOW)	1 - 2	Remove wrapper and place in a microwave-safe bowl.
To brown Ground Beef , 1 pound (450 g)	P10 (High)	4 - 5	Crumble into a microwave-safe colander set into another dish. Stir twice. Drain grease.
To steam Hand Towels - 4	P10 (High)	20 - 30 sec.	Soak in water, then wring out excess. Place on a microwave-safe dish. Heat. Present immediately.
To soften Ice Cream , ½ gallon (2 L)	P3 (MED-LOW)	1 - 1½	Check often to prevent melting.
Cup of liquid boiling water, broth , etc. 1 cup, 8 oz. (250 mL) 2 cups, 16 oz. (500 mL) to heat milk 1 cup, 8 oz. (250 mL) 2 cups, 16 oz. (500 mL)	P10 (High) P7 (MED-HIGH)	2½ - 3 4 2 - 3 4 - 5	Heated liquids can erupt if not stirred. Do not heat liquids in microwave oven without stirring before and after heating.
To roast Nuts , 1½ cups (375 mL)	P10 (High)	4 - 5	
To toast Sesame Seeds , ¼ cup (50 mL)	P10 (High)	3 - 5	Place in a small microwave-safe bowl. Stir twice.
To skin Tomatoes (one at a time)	P10 (High)	30 sec.	Place tomato into a microwave-safe bowl containing boiling water. Rinse and peel. Repeat for each tomato.
To remove Cooking Odors	P10 (High)	5	Combine 1 to 1½ cups (250 - 375 mL) water with the juice and peel of one lemon in a small microwave-safe bowl. After heating, wipe interior of oven with a cloth.

Food Characteristics

Bone and Fat

Both bone and fat affect cooking. Bones may cause irregular cooking. Meat next to the tips of bones may overcook while meat positioned under a large bone, such as a ham bone, may be undercooked. Large amounts of fat absorb microwave energy and the meat next to these areas may overcook.

Density

Porous, airy foods such as breads, cakes or rolls take less time to cook than heavy, dense foods such as potatoes and roasts. When reheating donuts or other foods with different centers be very careful. Certain foods have centers made with sugar, water or fat and these centers attract microwaves (For ex., jelly donuts). When a jelly donut is heated, the jelly can become extremely hot while the exterior remains warm to the touch. This could result in a burn if the food is not allowed to cool properly in the center.

Quantity

Two potatoes take longer to cook than one potato. As the quantity of the food increases so does the cooking time. When cooking small amounts of food such as one or two potatoes, do not leave oven unattended. The moisture content in the food may decrease and a fire could result.

Shape

Uniform sizes heat more evenly. The thin end of a drumstick will cook more quickly than the meaty end. To compensate for irregular shapes, place thin parts toward the center of the dish and thick pieces toward the edge.

Size

Thin pieces cook more quickly than thick pieces.

Starting Temperature

Foods that are room temperature take less time to cook than if they are chilled or refrigerated or frozen.

Cooking Techniques

Piercing

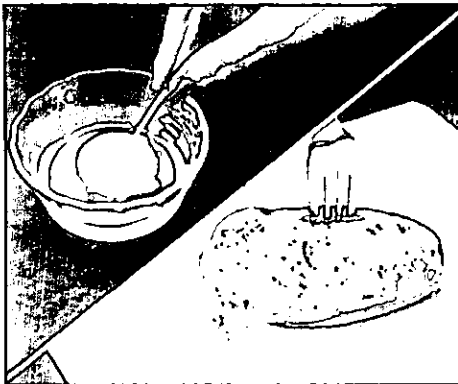

Foods with skins or membranes must be pierced, scored or have a strip of skin peeled before cooking to allow steam to escape. Pierce whole egg yolks and whites, clams, oysters, chicken livers, whole potatoes and whole vegetables. Whole apples or new potatoes should have a 1-inch strip of skin peeled before cooking. Score sausages and frankfurters.

Browning



Foods will not have the same brown appearance as conventionally cooked foods or those foods which are cooked utilizing a browning feature. Meats and poultry may be coated with browning sauce, Worcestershire sauce, barbecue sauce or shake-on browning sauce. To use, combine browning sauce with melted butter or margarine; brush on before cooking. For quick breads or muffins, brown sugar can be used in the recipe in place of granulated sugar, or the surface can be sprinkled with dark spices before baking.

Cooking Techniques

Spacing

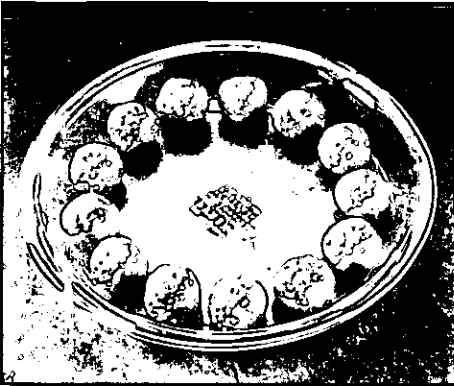

Individual foods, such as baked potatoes, cupcakes and appetizers, will cook more evenly if placed in the oven equal distances apart. When possible, arrange foods in a circular pattern.

Covering

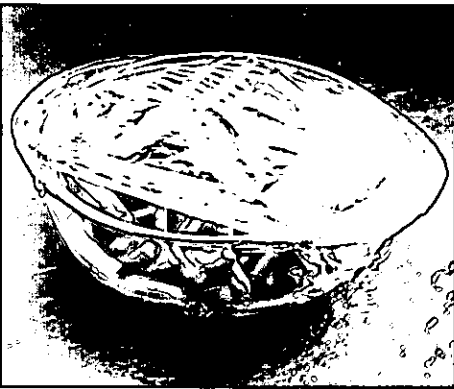

As with conventional cooking, moisture evaporates during microwave cooking. Casserole lids or plastic wrap are used for a tighter seal. When using plastic wrap, vent the plastic wrap by folding back part of the plastic wrap from the edge of the dish to allow steam to escape. Loosen or remove plastic wrap as recipe directs for stand time. When removing plastic wrap covers, as well as any glass lids, be careful to remove them away from you to avoid steam burns. Various degrees of moisture retention are also obtained by using wax paper or paper towels. However, unless specified, a recipe is cooked covered.

Shielding

Thin areas of meat and poultry cook more quickly than meaty portions. To prevent overcooking, these thin areas can be shielded with strips of aluminum foil. Wooden toothpicks may be used to hold the foil in place.

Timing

A range in cooking time is given in each recipe. The time range compensates for the uncontrollable differences in food shapes, starting temperature and regional preferences. Always cook food for the minimum cooking time given in a recipe and check for doneness. If the food is undercooked, continue cooking. It is easier to add time to an undercooked product. Once the food is overcooked, nothing can be done.

Stirring

Stirring is usually necessary during microwave cooking. We have noted when stirring is helpful, using the words once, twice, frequently or occasionally to describe the amount of stirring necessary. Always bring the cooked outside edges toward the center and the less cooked center portions toward the outside of the dish.

Rearranging

Rearrange small items such as chicken pieces, shrimp, hamburger patties or pork chops. Rearrange pieces from the edge to the center and pieces from the center to the edge of the dish.

Turning

It is not possible to stir some foods to redistribute the heat. At times, microwave energy will concentrate in one area of a food. To help insure even cooking, these foods need to be turned. Turn over large foods, such as roasts or turkeys, halfway through cooking.

Stand Time

Most foods will continue to cook by conduction after the microwave oven is turned off. In meat cookery, the internal temperature will rise 5°F to 15°F (3°C to 8°C), if allowed to stand, tented with foil, for 10 to 15 minutes. Casseroles and vegetables need a shorter amount of standing time, but this standing time is necessary to allow foods to complete cooking to the center without overcooking on the edges.

Test for Doneness

The same tests for doneness used in conventional cooking may be used for microwave cooking. Meat is done when fork-tender or splits at fibers. Chicken is done when juices are clear yellow and drumstick moves freely. Fish is done when it flakes and is opaque. Cake is done when a toothpick or cake tester is inserted and comes out clean. Candy is done when it reaches the proper temperature for each stage of crystallization.

Care of Your Microwave Oven

BEFORE CLEANING:

Unplug at socket of the oven. If impossible, leave oven door open to prevent oven from accidentally turning on.

AFTER CLEANING:

Be sure to replace the Roller Ring and Glass Tray in the proper position and press **Stop/Reset** Pad to clear the Display Window.

Menu Label:

Do not remove WIPE with a damp cloth.

Glass Tray:

Remove and wash in warm soapy water or in a dishwasher.

Outside oven surfaces:

Clean with a damp cloth. To prevent damage to the operating parts inside the oven, water should not be allowed to seep into ventilation openings.

Inside of the oven:

Wipe with a damp cloth. Mild detergent may be used if the oven gets very dirty. The use of harsh detergent or abrasives is not recommended.

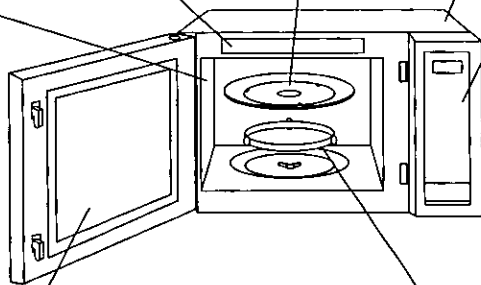

Control Panel:

* Covered with a removable protective film to prevent scratches during shipping. Small bubbles may appear under this film.

(Hint - To remove film, apply masking or clear tape to an exposed corner and pull gently.)

* If the Control Panel becomes wet, clean it with a soft dry cloth. Do not use harsh detergents or abrasives on the Control Panel.

Oven Door:

Wipe with a soft cloth when steam accumulates inside or around the outside of the oven door. During cooking, especially under high humidity conditions, steam is given off from the food. (Some steam will condense on cooler surfaces, such as the oven door. This is normal.) Inside surface is covered with a heat and vapour barrier film. Do not remove.

Roller Ring and oven cavity floor:

Wipe the bottom surface of the oven with mild detergent water or window cleaner and dry. Roller Ring may be washed in mild soapy water or dishwasher. These areas should be kept clean to avoid excessive noise.

ORDER FORM

For more information regarding microwave cooking, order our new **COOKING GUIDE** (68 pages of recipes & charts).

DESCRIPTION

Instruction / Operating Manual (this book)

COOKING GUIDE

Glass Tray

Roller Ring Assembly

PART NUMBER

F00035C00AP

B000B8250AP

A06014M00AP (NN-S961)

B06014W00AP (NN-S761)

B290D4M00AP (NN-S961)

B290D9330AP (NN-S761)

For pricing quotes, call or write the Parts & Literature Department at the phone or address listed below. Please have your credit card information readily available.

Shipping & handling are not included. Price & availability subject to change. Sorry, no COD's.

PANASONIC SERVICES COMPANY

20421 84th Avenue South

Kent, WA 98032

(800) 833-9626 - Phone

(800) 237-9080 - FAX

You can purchase parts, accessories or locate your nearest servicer by visiting our Web Site:

Web Site: <http://www.Panasonic.com>

Before Requesting Service

All these things are normal:

The oven causes interference with my TV.

Some radio and TV interference might occur when you cook with the microwave oven. This interference is similar to the interference caused by small appliances such as mixers, vacuums, blow dryers, etc. It does not indicate a problem with your oven.

Steam accumulates on the oven door and warm air comes from the oven vents.

During cooking, steam and warm air are given off from the food. Most of the steam and warm air are removed from the oven by the air which circulates in the oven cavity. However, some steam will condense on cooler surfaces such as the oven door. This is normal.

I accidentally ran my microwave oven without any food in it.

Running the oven empty for a short time will not damage the oven. However, we do not recommend operating the microwave oven without any food in it.

PROBLEM	POSSIBLE CAUSE	REMEDY
Oven will not turn on.	The oven is not plugged in securely.	Remove plug from outlet, wait 10 seconds and reinsert.
	Circuit breaker or fuse is tripped or blown.	Reset circuit breaker or replace fuse.
	There is a problem with the outlet.	Plug another appliance into the outlet to check if it is working.
Oven will not start cooking.	The door is not closed completely.	Close the oven door securely.
	Start Pad was not pressed after programming.	Press Start Pad.
	Another program is already entered into the oven.	Press Stop/Reset Pad to cancel the previous program and enter new program.
	The program is not correct.	Program again according to the Operating Instructions.
	Stop/Reset Pad has been pressed accidentally.	Program oven again.
The Glass Tray wobbles.	The Glass Tray is not positioned properly on the Roller Ring or there is food under the Roller Ring.	Take out Glass Tray and Roller Ring. Wipe with a damp cloth and reset Roller Ring and Glass Tray properly.
When the oven is operating, there is noise coming from the glass tray.	The Roller Ring and oven bottom are dirty.	Clean these parts according to Care of Your Microwave Oven .
The word "Child" appears in the Display Window .	The CHILD LOCK was activated by pressing Start pad 3 times.	Deactivate LOCK by pressing Stop/Reset pad 3 times.

Warranty & Service

PANASONIC MICROWAVE OVEN LIMITED WARRANTY

Panasonic Consumer Electronics Company or Panasonic Sales Company (collectively referred to as "the warrantor") will repair this product with new or refurbished parts in exchange for defective parts, free of charge, in the USA or Puerto Rico from the date of original purchase in the event of a defect in materials or workmanship as follows (all time periods start from the date of original purchase):

Parts - one (1) year (except magnetron).

Magnetron Tube - five (5) years.

Labor - one (1) year on all parts (including, without limitations, magnetron tube). After the labor warranty has expired, the purchaser pays for all labor charges for removal and installation of parts (including, without limitation, magnetron tube).

Carry-in or mail-in service in the USA or Puerto Rico can be obtained during the warranty period by contacting a Panasonic Services Company (PASC) Factory Servicenter listed in the Servicenter Directory. Or call, toll free, **1-800-211-PANA** to locate a PASC authorized Servicenter. Carry-in or mail-in service in Puerto Rico can be obtained during the warranty period by calling the Panasonic Sales Company telephone number listed in the Servicenter Directory.

This warranty is extended only to the original purchaser. A purchase receipt or other proof of date of original purchase will be required before warranty service is rendered.

This warranty only covers failures due to defects in materials or workmanship which occur during normal use and does not cover glass, plastic parts, temperature probes (if included), and the exterior and interior finish. The warranty does not cover damages which occur in shipment, or failures which are caused by products not supplied by the warrantor, or failures

which result from accident, misuse, abuse, neglect, mishandling, misapplication, faulty installation, improper set-up adjustments, operation and/or maintenance, or alteration, modification, power line surge, improper voltage supply, lightning damage, or commercial use such as hotel, office, restaurant or other business or rental use of the product, or service by anyone other than a PASC Factory Servicenter or a PASC authorized Servicenter, or damage that is attributable to acts of God.

LIMITS AND EXCLUSIONS

There are no express warranties except as listed above.

THE WARRANTOR SHALL NOT BE LIABLE FOR INCIDENTAL OR CONSEQUENTIAL DAMAGES RESULTING FROM THE USE OF THIS PRODUCT, OR ARISING OUT OF ANY BREACH OF THIS WARRANTY. ALL EXPRESS AND IMPLIED WARRANTIES, INCLUDING THE WARRANTIES OF MERCHANTABILITY, AND FITNESS FOR A PARTICULAR PURPOSE, ARE LIMITED TO THE APPLICABLE WARRANTY PERIOD SET FORTH ABOVE.

Some states do not allow the exclusion or limitation of incidental or consequential damages, or limitations on how long an implied warranty lasts, so the above exclusions or limitations may not apply to you.

This warranty gives you specific legal rights and you may also have other rights which vary from state to state. If a problem with this product develops during or after the warranty period, you may contact your dealer or Servicenter. If the problem is not handled to your satisfaction, then write to the Customer Satisfaction Center.

Factory Servicenters Locations

CALIFORNIA

6550 Katella Ave.
Cypress, CA 90630

800 Dubuque Ave.
S. San Francisco,
CA 94080

3878 Ruffin Rd., Suite A
San Diego, CA 92123

COLORADO

1640 South Abilene St.
Suite D
Aurora, CO 80012

FLORIDA

3700 North 29th Ave.
Suite 102
Hollywood, FL 33020

GEORGIA

8655 Roswell Road
Suite 100
Atlanta, GA 30350

ILLINOIS

9060 Golf Road
Niles, IL 60714

1703 N. Randall Road
Elgin, IL 60123
(Pick up/Drop off only)

MARYLAND

62 Mountain Road
Glen Burnie, MD 21061

MASSACHUSETTS

60 Glacier Drive, Suite G
Westwood, MA 02090

MINNESOTA

7850-12th Ave. South
Airport Business Center
Bloomington, MN 55425

OHIO

2236 Waycross Road
Civic Center Plaza
Forest Park, OH 45240

PENNSYLVANIA

2221 Cabot Blvd. West
Suite B
Langhorne, PA 19047

TEXAS

13615 Welch Road,
Suite 101
Farmers Branch,
TX 75244

WASHINGTON























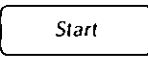

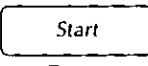

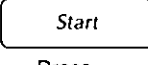



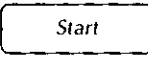

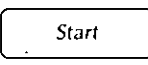

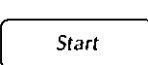

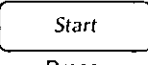

20425-84th Ave. So.
Kent, WA 98032

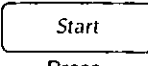
HAWAII

99-859 Iwaiwa Street
Aiea, Hawaii 96701
Phone (808) 488-1996
Fax (808) 486-4639

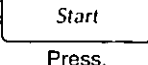
Puerto Rico: Matsushita Electric of Puerto Rico, Inc. Panasonic Sales Company / Factory Servicenter
Ave. 65 de Infanteria, Km. 9.5, San Gabriel Industrial Park, Carolina, Puerto Rico 00985
Phone (787) 750-4300 Fax (787) 768-2910

QUICK GUIDE TO OPERATION

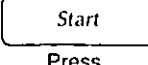
Feature	How to Operate
To use Function (☛ page 7)	 Press. →  Thru  →  or  or  Select Category. Select Option.
To Set Clock (☛ page 8)	 Press once. →  Thru  →  Press once. Enter time of day.
To Set Power and Time (☛ page 8)	 Press to select Power Level →  Thru  Set cooking time. →  Press.
To reheat using Sensor Reheat (☛ page 11)	 Press. →  Optional. →  Press.
To Cook using Sensor Cook (☛ page 11)	e.g.  Select category. →  Optional. →  Press.
To Defrost using Inverter Turbo Defrost (☛ page 9)	 Press. →  Thru  Set weight. →  Press.
To Cook using Popcorn (☛ page 8)	 Select weight. →  Press.
To Cook using Quick Min (☛ page 9)	 (up to 10 min.) →  Press.
To use Keep Warm (☛ page 9)	 Press to select category. →  Press to select quantity. →  Press.
To Use as a Kitchen Timer (☛ page 14)	 Press once. →  Thru  →  Press.
To Set Stand Time (☛ page 14)	(Input up to 4-stage cooking programs.) →  Press once. →  Thru  →  Press.
To Set Delay Start (☛ page 14)	 Press once. →  Thru  → (Input up to 4-stage cooking programs.) →  Press.

Panasonic Consumer Electronics Company, Division of Matsushita Electric Corporation of America
One Panasonic Way
Secaucus, New Jersey 07094

Panasonic Sales Company, Division of Matsushita Electric of Puerto Rico, Inc. ("PSC")
Ave. 65 de Infantería, Km. 9.5
San Gabriel Industrial Park,
Carolina, Puerto Rico 00985

F00035C00AP
CR0101-0
Printed in China