

This Owner's Manual is provided and hosted by [Appliance Factory Parts](#).



# LG LRE30755SB Owner's Manual

[Shop genuine replacement parts for LG LRE30755SB](#)



[Find Your LG Electric Range Parts - Select From 91 Models](#)

----- Manual continues below -----



Internal Use Only



Website <http://us.lgservice.com>

# 30" Freestanding Electric Range **SERVICE MANUAL**

**MODEL: LRE30451SW / SB / ST**

## **CAUTION**

BEFORE SERVICING THE UNIT, READ THE SAFETY PRECAUTIONS IN THIS MANUAL.

P/NO : 3828W5S6294

December, 2005  
Printed in Korea

# FORWARD

This LG Service Manual, “30” Freestanding Self-Cleaning Electric Range,” provides the technician with information on the operation and service of the Freestanding Self-Cleaning Electric Range. It is to be used as a training Service Manual. For specific information on the model being serviced, refer to the “Owner’s Manual” or “Tech Sheet” provided with the electric range.

## SAFETY PRECAUTIONS

- Repairs of the appliance should be carried out by a licensed technician only. Incorrect repairs may result in dangerous situations. If you need repairs, contact an LG Service Center or your dealer.
- If the power cord is defective, it must be replaced by a qualified service agent with a UL listed range cord.
- Electrical leads and cables should not be allowed to touch the oven.
- Rating plate is located on the left side of warming drawer.
- The power supply of the appliance should be turned off when it is being repaired.



### WARNING

- To avoid risk of severe personal injury or death, disconnect power before working/servicing on appliance to avoid electrical shock.
- When the oven operates, the interior parts will be very hot.

LG Electronics assumes no responsibility for any repairs made on our products by anyone other than Authorized Service Technicians.

# TABLE OF CONTENTS

	(PAGE)
<b>GENERAL</b> .....	<b>1-1 ~ 1-4</b>
• Important safety instructions .....	1-1 ~ 1-2
• Model & Serial number label and tech sheet locations .....	1-3
• Specifications .....	1-4
<b>USING YOUR RANGE</b> .....	<b>2-1 ~ 2-5</b>
• General information .....	2-1
• Control panel features .....	2-2 ~ 2-5
- To turn on a single surface unit (Right Rear, Left Rear, Left Front)	
- To turn on a dual surface unit (Right Front)	
- To set the warming zone control	
- Clock	
- Start, Clean/Off and On/Off pad	
- Oven light	
- Timer On/Off	
- Convection auto conversion	
- Thermostat adjustment	
- Preheating alarm light On/Off	
- Beeper volume	
- Temperature unit (°F or °C)	
- Bake, Timed Bake, Delayed timed Bake	
- Broil	
- Convection Bake	
- Convection Roast	
- Cook & Warm	
- Oven lockout	
- Changing hour mode on clock (12HR, 24HR)	
- Proof	
- Self-Clean	
- Warming drawer	
<b>COMPONENT ACCESS</b> .....	<b>3-1 ~ 3-17</b>
• Component Locations .....	3-1
• Removing the Back, Control cover and Key membrane Assembly .....	3-2
• Removing the Control Power Supply and Power Control Board (PCB) .....	3-3
• Removing the Surface Element and the Ceramic Glass Cooktop .....	3-4
• Removing the Door Latch and the Door Switch .....	3-5
• Removing the BROIL element .....	3-6
• Removing the BAKE element .....	3-7
• Removing the CONVECTION Fan blade and Fan motor .....	3-8
• Removing the Oven light & Socket assembly .....	3-9
• Removing the latch drive assembly .....	3-10
- Door locking mechanism .....	3-10
• Removing the Oven temperature Sensor .....	3-11
• Removing the storage drawer .....	3-12
• Removing & Replacing the Lift-off Oven Door .....	3-13
• Removing the Oven Door Handle & Glass .....	3-14 ~ 3-15
• Removing the Oven Door Gasket .....	3-16
• Removing a Side Panel .....	3-17

<b>COMPONENT TEST</b> .....	<b>4-1 ~ 4-7</b>
• Convection Motor .....	4-1
• Door locking Motor .....	4-2
• Micro Switch (normally open type) .....	4-2
• LVT .....	4-2
• Oven Sensor .....	4-3
• Door switch .....	4-3
• Broil element .....	4-3
• Bake element .....	4-3
• Oven lamp .....	4-4
• Single surface unit(RF, LR, RR) .....	4-5
• Warming Zone(CR) .....	4-6
• Dual surface unit(LF) .....	4-7
<b>COMPOSITION OF CONTROL</b> .....	<b>5-1 ~ 5-4</b>
• Main PCB .....	5-2
• Cook-top display PCB .....	5-3
• Oven relay PCB .....	5-3
<b>FAILURE MODE FLOW CHART</b> .....	<b>6-1 ~ 6-11</b>
• No display (No power) .....	6-1 ~ 6-4
• Oven does not heat .....	6-5 ~ 6-7
• Cook-top does not heat .....	6-8 ~ 6-9
• Oven lamp does not operate .....	6-10
• No key input .....	6-11
<b>FAILURE CODES</b> .....	<b>7-0</b>
<b>F-CODE FLOW CHART</b> .....	<b>7-1 ~ 7-10</b>
• F-1 error .....	7-1
• F-2 error .....	7-2 ~ 7-4
• F-3, F-4 error .....	7-5 ~ 7-6
• F-9 error .....	7-9 ~ 7-10
<b>TROUBLE SHOOTING</b> .....	<b>8-1 ~ 8-3</b>
<b>SCHEMATIC DIAGRAM</b> .....	<b>9-1</b>
• STRIP CIRCUITS .....	9-2 ~ 9-5
<b>EXPLODED VIEW</b> .....	<b>10-1 ~ 10-10</b>
<b>REPLACEMENT PARTS LIST</b> .....	<b>11-1 ~ 11-9</b>

# GENERAL

## IMPORTANT SAFETY INSTRUCTIONS

Read and follow all instructions before using your oven to prevent the risk of fire, electric shock, injury to person, or damage when using the range. This guide don't cover all possible conditions that may occur. For further assistance contact your service agent or manufacturer.



### WARNING

This symbol will help alert you to hazards or unsafe practices which could cause serious bodily harm or death.

- Be sure your appliance is properly installed and grounded by a qualified technician.
- Do not repair or replace any part of the appliance unless specifically recommended in the manual. All other servicing should be referred to a qualified technician.
- Always disconnect power to appliance before servicing by removing the fuse or switching off the circuit breaker



### WARNING

- INJURIES CAN OCCUR IF THE RANGE TIPS
- INSTALL ANTI-TIP DEVICE PACKED WITH RANGE
- FOLLOW ALL INSTALLATION INSTRUCTIONS

To reduce the risk of tipping of the range, the range must be secured by properly installed anti-tip devices. To check if the bracket is installed properly,

- **Warning drawer** : grasp the top rear edge of the Range and carefully attempt to tilt it forward. verify that the anti-tip devices are engaged.
- **Storage drawer** : Remove drawer and verify leveling leg is inserted into and fully secured by the anti-tip devices.

Refer to the installation manual for proper anti-tip bracket installation.

- Do not step, lean or sit on the doors of the range -this can cause the range to tip, resulting in burns or serious injuries.



### WARNING

- **DO NOT TOUCH HEATING ELEMENTS OR INTERIOR SURFACES OF OVEN** – Heating elements may be hot even though they are dark in color. Interior surfaces of an oven become hot enough to cause burns. During and after use, do not touch, or let clothing or other flammable materials contact heating elements or interior surfaces of oven until they have had sufficient time to cool. Other surfaces of the appliance may become hot enough to cause burns – among these surfaces are oven vent openings and surfaces near these openings, oven doors, and windows of oven doors.



### CAUTION

**Do not store items of interest to children in cabinets above a range or on the back guard of a range** – children climbing on the range to reach items could be seriously injured.

- **Do Not Leave Children Alone** - Children should not be left alone or unattended in area where appliance is in use. They should never be allowed to sit or stand on any part of the appliance.
- **Never Use Your Appliance for Warming or Heating the Room.**
- **Storage in or on Appliance** – Flammable materials should not be stored in an oven or near surface units. Be sure all packing materials are removed from the appliance before operating it. Keep plastics, clothes and paper away from parts of the appliance that may become hot
- **Wear Proper Apparel** – Loose-fitting or hanging garments should never be worn while using the appliance.
- **Do Not Use Water on Grease Fires** – Turn off oven to avoid spreading the flame. Smother the fire or flame by closing the door or use dry chemical, baking soda or foam- type extinguisher.
- **Use Only Dry Potholders** – Moist or damp potholders on hot surfaces may result in burns from steam. Do not let potholder touch hot heating elements. Do not use a towel or other bulky cloth.



### WARNING

#### SURFACES

- **DO NOT TOUCH SURFACE UNITS OR AREAS NEAR UNITS** – Surface units may be hot even though they are dark in color. Areas near surface units may become hot enough to cause burns. During and after use, do not touch, or let clothing or other flammable materials contact surface units or areas near units until they have had sufficient time to cool. Among these areas are the cook-top and surfaces close to the cook-top.



### WARNING

To avoid risk of electrical shock, personal injury, or death, make sure your range has been properly grounded and always disconnect it from main power supply before any servicing.

# GENERAL

## IMPORTANT SAFETY INSTRUCTIONS

### SURFACE COOKING UNITS

- **Use Proper Pan Size** – This appliance is equipped with one or more surface units of different sizes. Select utensils having flat bottoms large enough to cover the surface unit heating element. The use of undersized utensils will expose a portion of the heating element to direct contact and may result in ignition of clothing. Proper relationship of utensil to burner will also improve efficiency.
- **Never Leave Surface Units Unattended at High Heat Settings** – Boil overs may cause smoking and greasy spillovers may ignite.
- **Make Sure Reflector Pans or Drip Bowls Are in Place** – Absence of these pans or bowls during cooking may subject wiring or components underneath to damage.
- **Protective Liners** – Do not use aluminum foil to line surface unit drip bowls or oven bottoms, except as suggested in the manual. Improper installation of these liners may result in a risk of electric shock, or fire.
- **Glazed Cooking Utensils** – Only certain types of glass, glass/ceramic, ceramic, earthenware, or other glazed utensils are suitable for range-top service without breaking due to the sudden change in temperature.
- **Utensil Handles Should Be Turned Inward and Not Extend Over Adjacent Surface Units** – To reduce the risk of burns, ignition of flammable materials, and spillage due to unintentional contact with the utensil, the handle of a utensil should be positioned so that it is turned inward, and does not extend over adjacent surface units.
- **Do Not Soak Removable Heating Elements** – Heating elements should never be immersed in water.
- Be sure you know which control pads operate each surface unit. Make sure you turned on the correct surface unit.

### SELF-CLEAN OVENS

- **Do Not Clean Door Gasket** – The door gasket is essential for a good seal. Care should be taken not to rub, damage, or move the gasket.
- **Do Not Use Oven Cleaners** – No commercial oven cleaner or oven liner protective coating of any kind should be used in or around any part of the oven.
- **Clean in the self-clean cycle only parts listed in this manual.** Before self-cleaning the oven, remove the broiler pan and any utensils from the oven.
- **Never keep pet birds in the kitchen** – the health of birds is extremely sensitive to the fumes released during an oven self-clean cycle. Fumes may be harmful or fatal to birds. Move birds to well-ventilated room.
- **Important Instruction** – In the event the self-clean mode “F” code goes on, or three long beeps sound, oven is malfunctioning in the self-clean mode. Turn off or disconnect appliance from power supply and have serviced by a qualified technician.

### VENTILATING HOODS:

- **Clean Ventilating Hoods Frequently** – Grease should not be allowed to accumulate on hood or filter.
- **When flaming foods under the hood, turn the fan on.**

### OVEN

- **Use Care When Opening Door** – Let hot air or steam escape before you remove or replace food in the oven
- **Do Not Heat Unopened Food Containers** – Build-up of pressure may cause container to burst and result in injury.
- **Keep Oven Vent Ducts Unobstructed** – the oven vent is located above the left rear surface unit. this area could become hot during oven use. Never block this vent and never place plastic or heat-sensitive items on vent
- **Placement of Oven Racks** – Always place oven racks in desired location while oven is cool. If rack must be moved while oven is hot, do not let potholder contact hot heating element in oven.
- **Do Not** allow aluminum foil or meat probe to contact heating elements.

### GLASS/CERAMIC COOKING SURFACES

- **Do Not Cook on Broken Cook-Top** – If cook-top should break, cleaning solutions and spillovers may penetrate the broken cook-top and create a risk of electric shock. Contact a qualified technician immediately.
- **Clean Cook-Top With Caution** – If a wet sponge or cloth is used to wipe spills on a hot cooking area, be careful to avoid steam burn. Some cleaners can produce noxious fumes if applied to a hot surface.

### DEEP FAT FRYERS:

- Use extreme caution when moving the grease kettle or disposing of hot grease.

# GENERAL

## MODEL & SERIAL NUMBER LABEL AND TECH SHEET LOCATIONS

The Model/Serial Number label and Tech Sheet locations are shown below.

Model & Serial  
Number Location

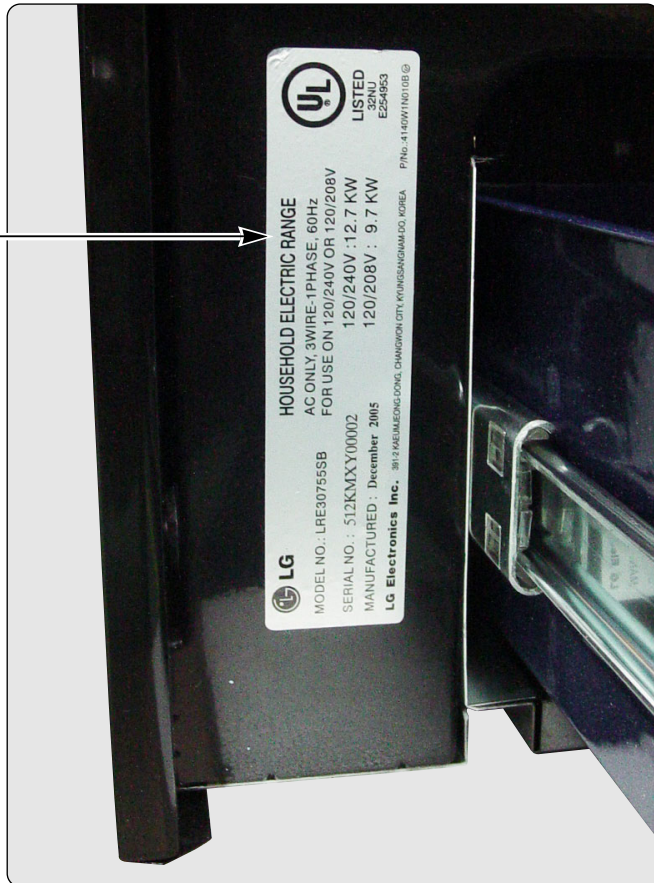

Tech Sheet Location  
(On Low Rear Cover)



# GENERAL

## SPECIFICATIONS

Model Number		LRE30451SW / SB / ST
<b>Category</b>		Convection
<b>Overall</b>	Width	30"
	Installation type	Freestanding
	Color availability	WH, BK, STS
<b>Control</b>	Oven	Keypad
	Cooktop	Keypad
	Display	LED
	Electronic clock & timer	Yes
	Control lock capability	Yes
	Audible preheat signal	Yes
	Special function	<ol style="list-style-type: none"> <li>1. Clock(12hr, 24hr)</li> <li>2. Temperature unit (F / C)</li> <li>3. Beeper Volume(High , Low, Mute)</li> <li>4. Smart oven light On/Off</li> <li>5. Convection auto conversion on/off</li> <li>6. Thermostat Adjustment</li> <li>7. Sabbath mode</li> </ol>
<b>Cooktop</b>	Material	Ceramic glass
	# of element	5
<b>Power</b>	LR	6"-1,200
	RR	6"-1,200
	CR	warming zone
	LF	Dual (6"/9"-1,200/2,500)
	RF	12"-2,700W
<b>Oven</b>	Capacity(cu.ft)	<b>5.6</b>
	Broil element	4000 watts
	Bake element	3400 watts
	Convection System	Yes
	-Convection element	No
	# of Racks	2 standards
	Interior oven light	120V, 40Watts
	Proof	Yes
	Cook & warm	Yes
	Favorites	No
	Door lockout	Yes
	Broiler pan	Yes
<b>Drawer</b>	Type	Storage drawer
	Element	-
	Warming rack	-
<b>Dimensions (inch)</b>	Oven Interior(W x H x D)	24 1/2 x 20 1/4 x 19 3/8
	Exterior - Width	29 7/8
	Exterior - Height	36 (cooktop), 47 5/8 (backguard top)
	Exterior - Depth	25 11/16 (Door), 28 (with handle)
	Net weight: Lbs (Kg)	181 lbs (82kg)
<b>Power</b>	Rating	11.2Kw(120/240V) / 8.9Kw(120/208V)

# USING YOUR RANGE

## GENERAL INFORMATION

### Rating Label

Model numbers are recorded on the rating label. Rating label is located on the lower front left corner of the oven frame. It can be seen by opening the storage drawer or warming drawer. Before ordering parts, write down the correct model and serial number from rating label. This avoids incorrect shipments and delays. Please refer to parts reference material when ordering replacement parts.

### Functional Operation

#### Bake Mode

Top and hidden bottom elements operate during bake. Bake can be used to cook foods which are normally baked. Oven must be preheated.

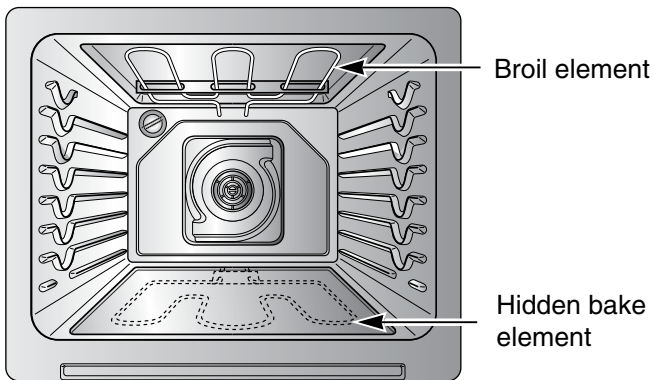

#### Convection Bake / Roast Mode

Upper element, lower element, Rear element (some model) and fan operate during convection bake. Convection bake should be used for cooking casseroles and roasting meats. Oven should be preheated for best results when using convection bake. Pans do not need to be staggered. Cooks approximately 25% quicker than bake.

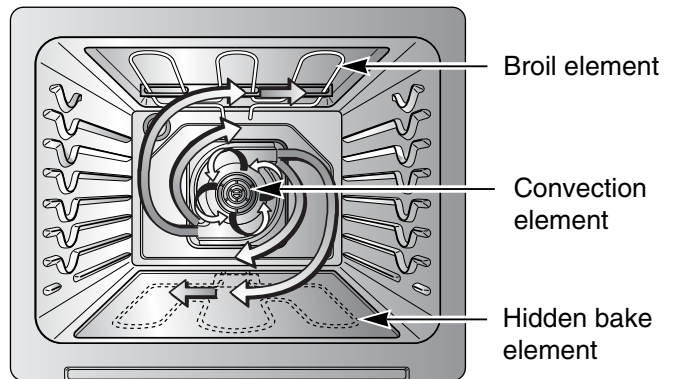

#### Cooking Guide

Refer to the owners manual for recommendations of times and temperatures. Times, rack position, and temperatures may vary depending on conditions and food type. For best results, always check food at minimum time. When roasting, choose rack position based on size of food item.

#### Broil Mode

Top element operates during broil. Broil can be used to cook foods which are normally broiled. Preheating is not required when using broil. All foods should be turned at least once except fish, which does not need to be turned.

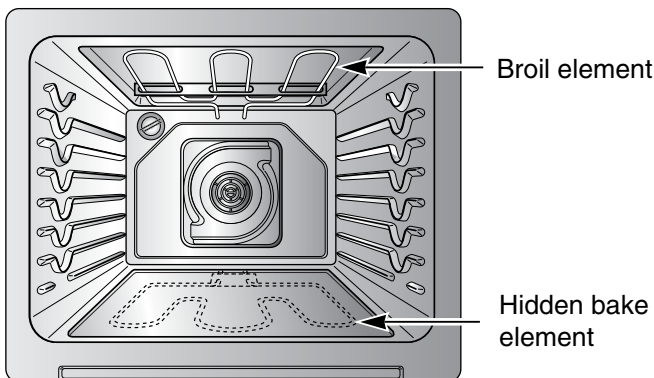

# USING YOUR RANGE

## CONTROL PANEL FEATURES

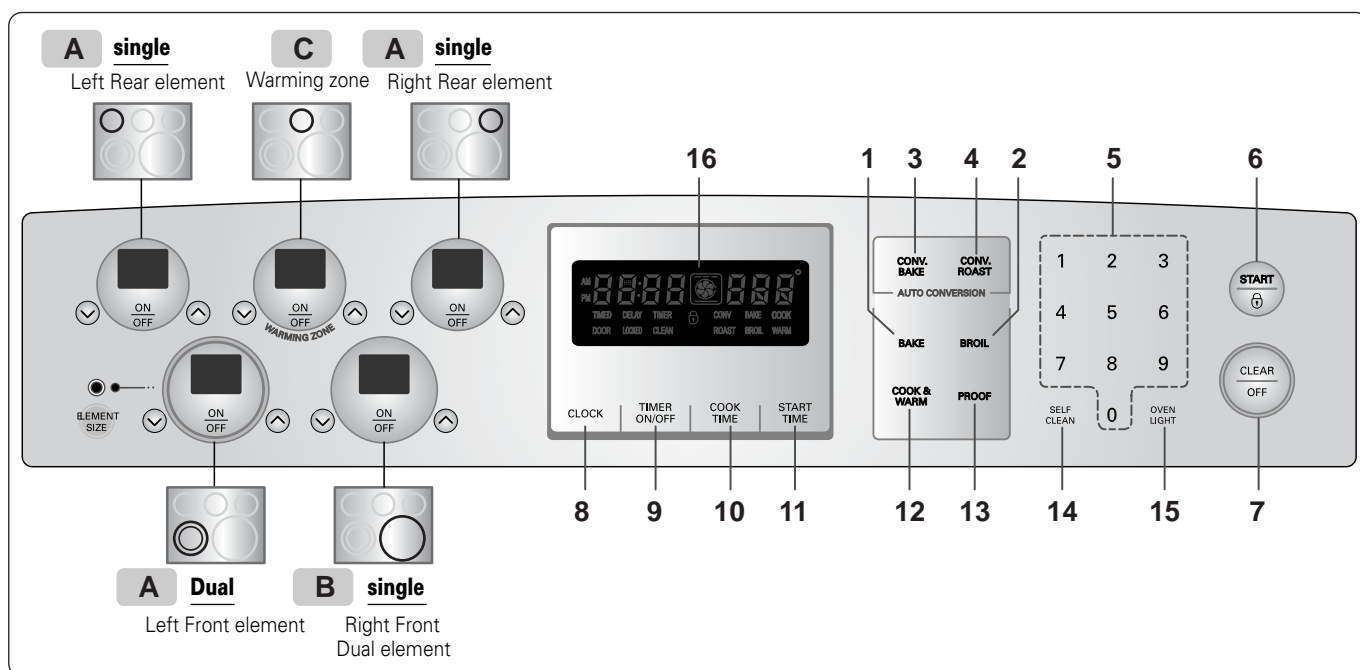

1. **BAKE PAD:** Press to select the bake function.
2. **BROIL PAD:** Press to select the broil function.
3. **CONVECTION BAKE PAD:** Press to select baking with the convection function.
4. **CONVECTION ROAST PAD:** Press to select roasting with the convection function.
5. **NUMBER PADS:** Use to set any function requiring numbers such as the time of day on the clock, the timer, the oven temperature, the start time and length of operation for timed baking.
6. **START PAD:** Must be pressed to start any cooking or cleaning function.
7. **CLEAR/OFF PAD:** Press to cancel all oven operations except the clock and timer.
8. **CLOCK PAD:** Press before setting the time of day.
9. **TIMER ON/OFF PAD:** Press to select the timer feature.
10. **COOK TIME PAD:** Press and then use the number pads to set the amount of time you want your food to cook. The oven will shut off when the cooking time has run out.
11. **START TIME PAD:** Use along with BAKE, CONV. BAKE, CONV. ROAST, COOK TIME and SELF CLEAN pads to set the oven to start and stop automatically at a time you set.
12. **COOK & WARM PAD:** Press to keep cooked foods warm. See page 2-4 for pad operation.
13. **PROOF PAD:** Press to select a warm environment useful for rising yeast-leavened products.
14. **SELF CLEAN PAD:** Press to select self-cleaning function. See the using the Self-Cleaning Oven section.
15. **OVEN LIGHT PAD:** Press to turn the oven light on or off.
16. **DISPLAY**
  - A Single surface units**  
: Right Rear, Left Rear, Right Front
  - B Dual surface unit** : Left Front
  - C Warming Zone** : Center Rear

# USING YOUR RANGE

## A To turn on a single surface unit (Right Rear, Left Rear, Right Front)



1. Press **ON/OFF** pad for the desired element.
2. Press ( / ) pad to choose the desired setting.

## B To turn on a dual surface unit (Left Front)



1. Press **ON/OFF** pad
2. Press the **ELEMENT SIZE** pad as needed to select the desired burner size. When first selected, 9" size is on. The light above the **ELEMENT SIZE** pad indicates which size surface unit is on.
2. Press ( / ) pad to choose the desired setting.

### Note:

- Each time a pad is pressed a beep will sound.
- The power level decreases or increases by **0.5** from **9.0** through **3.0**. (by **0.2** from **3.0** through **1.0**)
- **Lo** is the lowest power level available.
- **"HS"** will appear when the unit is hot to touch

## C To set the warming zone control



1. Press **ON/OFF** pad at the warming zone.
2. Press ( / ) pad to choose the desired setting.

### Note:

- Each time a pad is pressed a beep will sound.
- The controls for the warming zone allow for 5 different heat settings : **Lo~Hi**
- **"HS"** will appear when the unit is hot to touch.

## 1. SETTING THE CLOCK



## 2. START, CLEAN/OFF AND ON/OFF PAD

1. Touch **START** pad to start oven.
2. Touch **CLEAR/OFF** pad to cancel a program during cooking or Erase during programming.
3. Touch **ON/OFF** pad to start or cancel the surface unit.

## 3. TO TURN ON/OFF THE OVEN LIGHT

The oven light automatically turns ON when the door is opened. The oven light may also be manually turned ON or OFF by pressing the **OVEN LIGHT** pad

**Note:** The oven light cannot be turned on if self-clean feature is active.

LGE Internal Use Only

## 4. TIMER ON/OFF

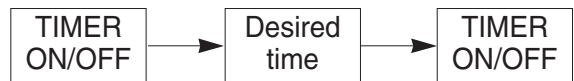

To cancel timer at any time, touch **TIMER ON/OFF** pad.

### Note:

1. If you press **TIMER ON/OFF** pad once, this allows you to select "seconds"  
(for example: if you press "5" and "6", it means 56 seconds)
2. If you press **TIMER ON/OFF** pad twice, this allows you to select "minutes"  
(for example: if you press "5" and "6", it means 56 minutes)

## 5. CHANGING HOUR MODE ON CLOCK (12HR, 24HR)

Press and hold the **COOK&WARM** pad for 3 seconds

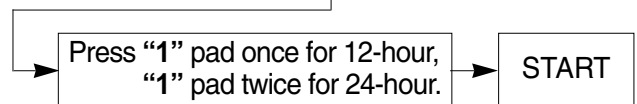

## 6. TEMPERATURE UNIT (°F or °C)

1. Press and hold **COOK&WARM** pad for 3 seconds
2. Press "2" pad once for °F  
or "2" pad twice for °C
3. Press **START** pad

## 7. BEEPER VOLUME

1. Press and hold **COOK&WARM** pad for 3 seconds
2. Press "3" pad once for "Beep Hi"  
Press "3" pad to switch beeper volume (HI, LO, OFF)
3. Press **START** pad

## 8. PREHEATING ALARM LIGHT ON/OFF

1. Press and hold **COOK&WARM** pad for 3 seconds
2. Press "4" pad once for **ON**  
or "4" pad twice for **OFF**
3. Press **START** pad

## 9. CONVECTION AUTO CONVERSION

1. Press and hold **COOK&WARM** pad for 3 seconds
2. Press "5" pad once for **ON**  
or "5" pad twice for **OFF**
3. Press **START** pad.

# USING YOUR RANGE

## 10. THERMOSTAT ADJUSTMENT

The oven temperature can be adjusted from -35°F (-19°C) to 35°F (19°C).

*Note:* The thermostat adjustments made with this feature will just change Bake, Convection Bake and Convection Roast temperature.

### To increase the oven temperature:

1. Press and hold **BAKE** pad for 3 seconds
2. Press the **desired temperature**
3. Press **START** pad.

### To decrease the oven temperature:

1. Press and hold **BAKE** pad for 3 seconds
2. Press the **desired temperature**
3. Press the **BAKE** pad once
4. Press **START** pad

## 11. BAKE, TIMED BAKE, DELAYED TIMED BAKE

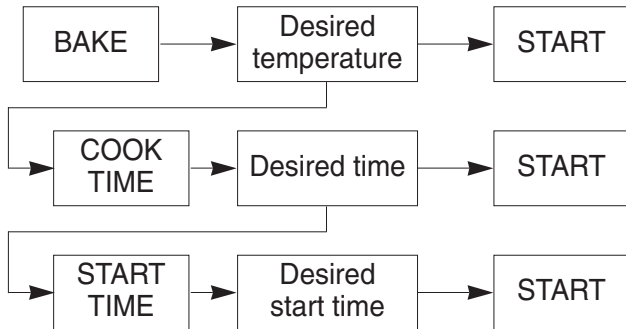

## 12. BROIL



## 13. CONVECTION BAKE

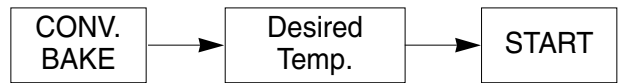

## 14. CONVECTION ROAST

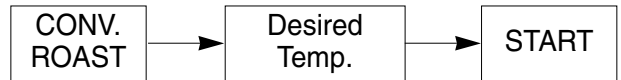

## 15. COOK & WARM



## 16. OVEN LOCKOUT

Press and hold the **START** pad for 3 seconds (to activate or reactivate LOCKOUT)

## 17. PROOF



## 18. SELF-CLEAN

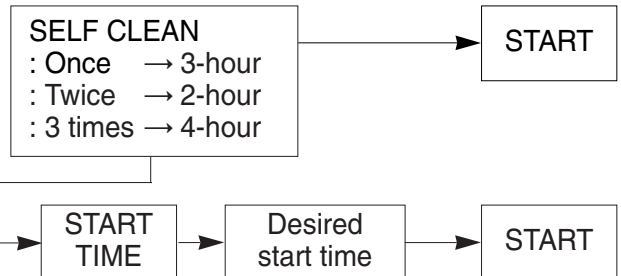

# COMPONENT ACCESS

This section instructs you on how to service each component inside the range. The components and their locations are shown below.

## COMPONENT LOCATIONS

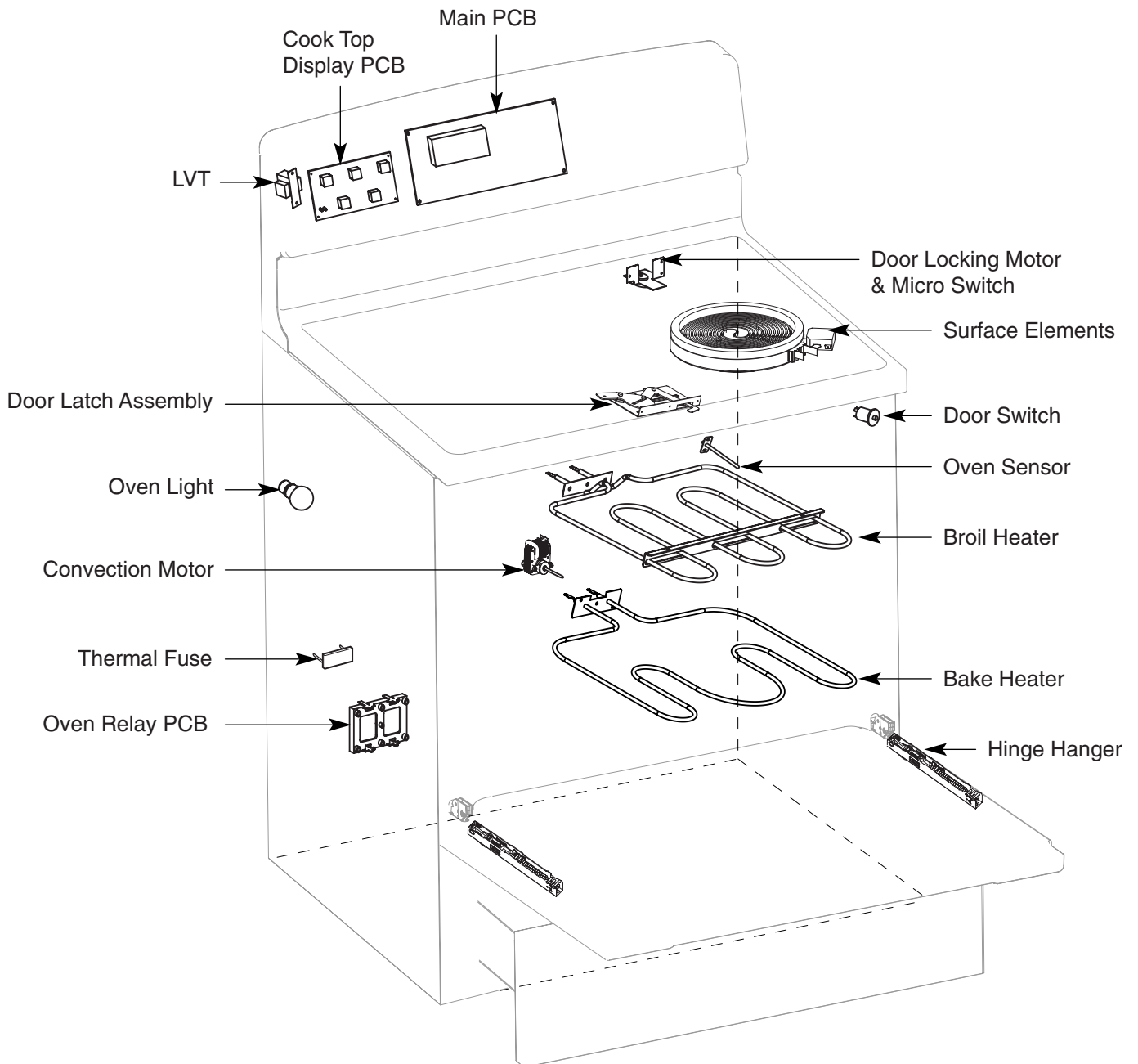

# COMPONENT ACCESS

## REMOVING THE BACK, CONTROL COVER AND KEY MEMBRANE ASSEMBLY

### **WARNING**

#### **ELECTRICAL SHOCK HAZARD**

Disconnect power before servicing the range.  
Replace all panels before operating range.  
Failure to do so can result in death or electrical shock.

### **CAUTION**

When you work on the electric range, be careful when handling the sheet metal parts. Sharp edges may be present, and you can cut yourself if you are not careful.

1. Turn off the electrical supply going to the range.
2. Pull the range away from the wall so that you can access the rear panel.
3. Remove the 16 screws from the rear panel and remove the panel.

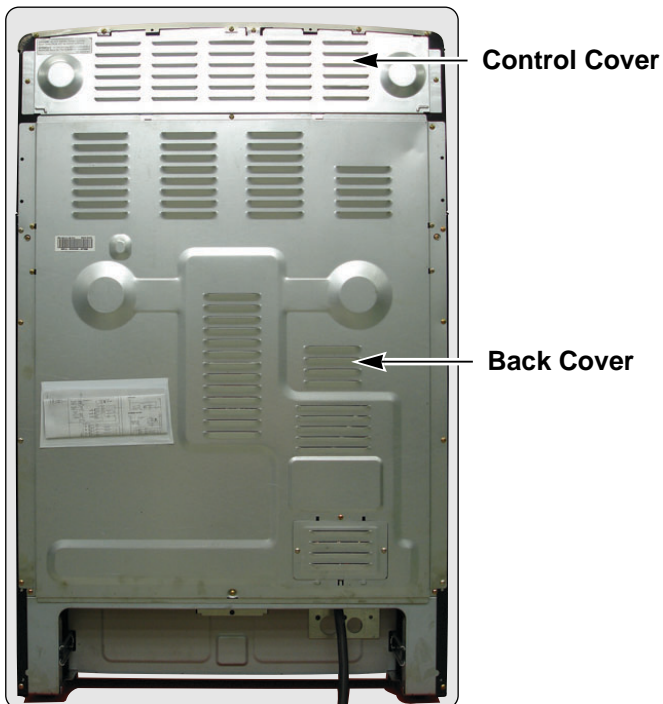

4. Remove the 3 screws from the rear control cover and remove the cover.
5. Remove 6 screws of PCB assembly and separate PCB assembly.
6. Remove 9 screws of KEY Membrane assembly and separate PCB assembly.

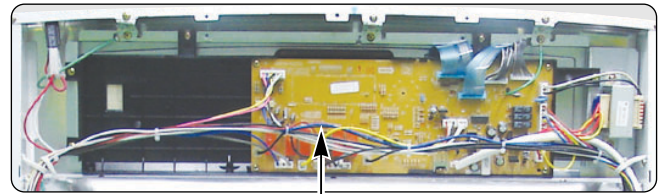

# COMPONENT ACCESS

## REMOVING THE CONTROL POWER SUPPLY AND POWER CONTROL BOARD (PCB)

### WARNING

#### ELECTRICAL SHOCK HAZARD

Disconnect power before servicing the range.  
Replace all panels before operating range.  
Failure to do so can result in death or electrical shock.

### CAUTION

When you work on the electric range, be careful when handling the sheet metal parts. Sharp edges may be present, and you can cut yourself if you are not careful.

1. Turn off the electrical supply going to the range.
2. Pull the range away from the wall so that you can access the rear panel.
3. Remove back cover & control cover (See step 3~4 on page 3-2)
4. There are 3 PCB's (power control board). When you check PCB, check the proper pcb in default mode and check main pcb.

**NOTE: Refer to the page 5-1~5-3 for composition of control board**

Main PCB

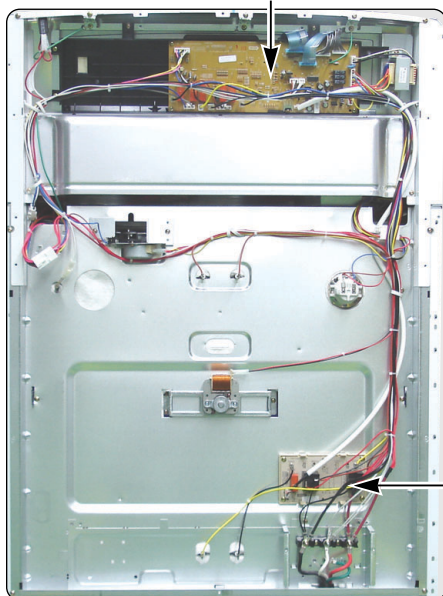

Oven  
Relay PCB

### 5. To remove the control power supply:

- a) Disconnect 2 connectors.
- b) Remove the two screws.

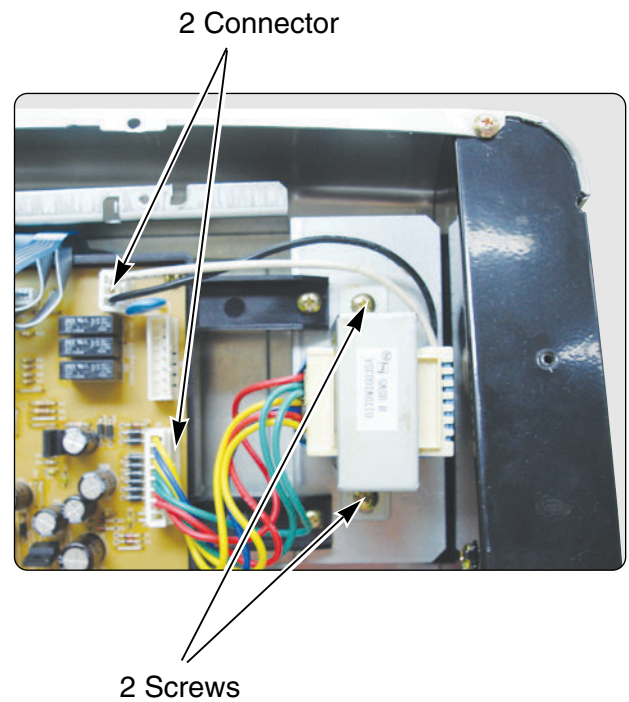

# COMPONENT ACCESS

## REMOVING THE SURFACE ELEMENTS AND THE CERAMIC GLASS COOKTOP

### WARNING

#### **ELECTRICAL SHOCK HAZARD**

Disconnect power before servicing the range.  
Replace all panels before operating range.  
Failure to do so can result in death or electrical shock.

### CERAMIC GLASS COOKTOP REMOVAL

#### **Step. 1**

Unplug the cord or disconnect power

#### **Step. 2**

Open oven door and remove the 3 screws located at the front of the cook-top, then close the door.

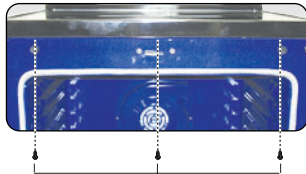

3 Screws

#### **Step. 3**

Lift up the cooktop front and Remove the ground screw securing ground wire

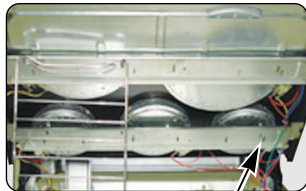

Ground Screws

#### **Step. 4**

Slightly lift up and pull up the cook-top and then unplug the 2 connectors at the back by squeezing side tabs

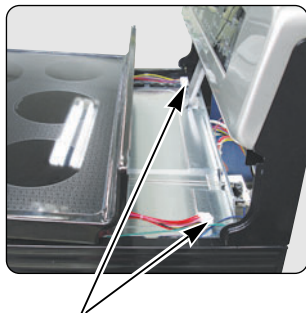

2 Connectors

#### **Step. 5**

Protect the cooktop surface and turn the assembly over.



Bracket screws

#### **Step. 6**

To remove the surface elements

- Remove the wires from the element and limiter terminals.
- Remove the element bracket screw (shown above) for the element you are servicing.

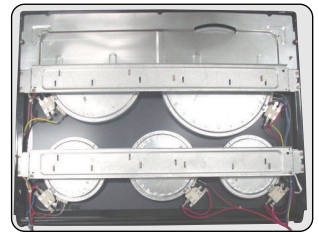

- Carefully lift the bottom of the bracket just far enough to remove the element.

REASSEMBLY NOTE: When you reinstall the element make sure that the wires are inserted into the correct tap then reinstall the bracket screw to secure it to the cooktop.

# COMPONENT ACCESS

## REMOVING THE DOOR LATCH & DOOR SWITCH

### **WARNING**

#### **ELECTRICAL SHOCK HAZARD**

Disconnect power before servicing the range.  
Replace all panels before operating range.  
Failure to do so can result in death or electrical shock.

### **CAUTION**

When you work on the electric range, be careful when handling the sheet metal parts. Sharp edges may be present, and you can cut yourself if you are not careful.

1. Turn off the electrical supply going to the range.
2. Open the oven door.
3. Raise the cooktop (see page 3-4 for the procedure).
4. To remove the door latch:
  - a) Remove the two screws from the door latch and remove the latch.



2 Screws

- b) Remove the door latch from the burner box and unhook the actuating rod.

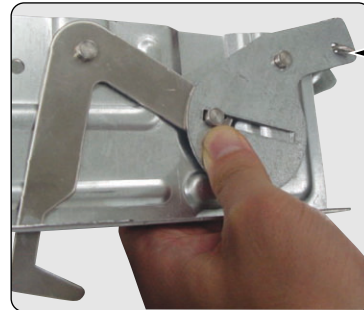

Unhook Actuating Rod

5. To remove the door switch:
  - a) If not already done, raise the cooktop (see page 3-4 for the procedure).
  - b) Remove the door switch from the range. To do this, squeeze tabs and use a ratchet extension or a small socket, and tap it out of the hole with a hammer.



- c) Disconnect the wires from the terminals.

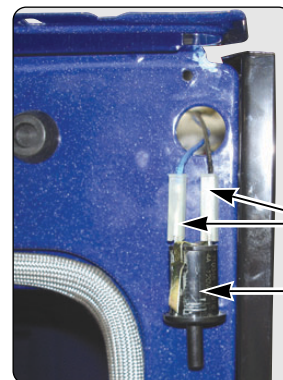

Wires

Door Switch

# COMPONENT ACCESS

## REMOVING THE BROIL ELEMENT

### **WARNING**

#### **ELECTRICAL SHOCK HAZARD**

Disconnect power before servicing the range.  
Replace all panels before operating range.  
Failure to do so can result in death or electrical shock.

### **CAUTION**

When you work on the electric range, be careful when handling the sheet metal parts. Sharp edges may be present, and you can cut yourself if you are not careful.

1. Turn off the electrical supply going to the range.
2. Open the oven door and remove the racks from inside the oven.
3. **To remove the broil element:**
  - a) Remove the 4 screws from the front and rear brackets.

- b) Pull the element forward so that you can access the terminals and disconnect the wires.

2 Terminals

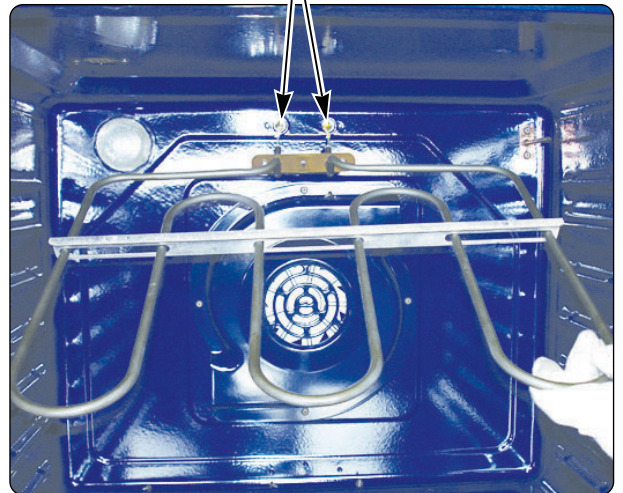

2 Upper bracket Screws

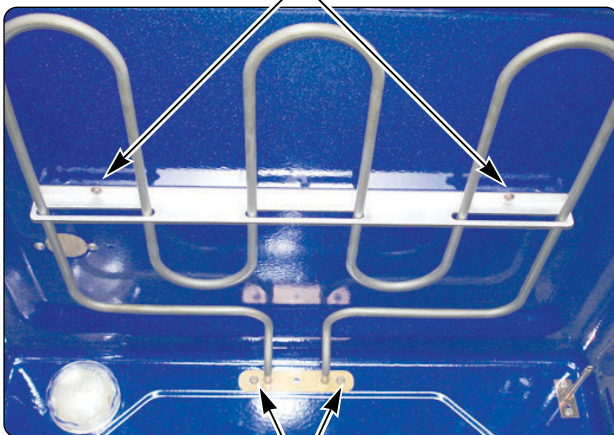

2 Rear bracket Screws

# COMPONENT ACCESS

## REMOVING THE HIDDEN BAKE ELEMENT

1. Unplug range or disconnect power.
2. Pull the range out of its mounting location so that you can access the rear of the unit.
3. Remove the rear panel from the unit.  
(See step 3 on page 3-2 for procedure)

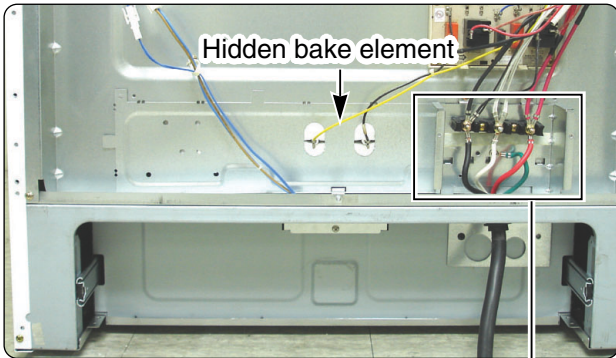

4. Remove the 2 screws of power cord assembly box and 1 ground screw.
5. Set the box aside

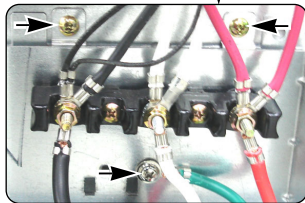

6. Cut the 9 points of flange and remove the bake heater cover.

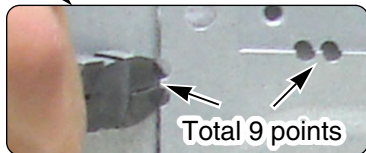
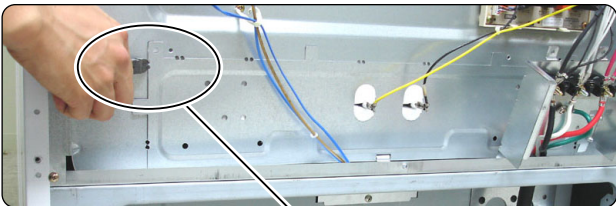

7. Bend the insulation glass fiber up.

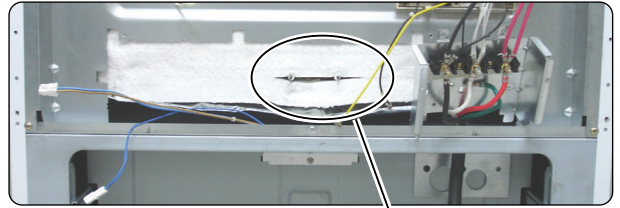

8. Remove two screws and bend up two flanges

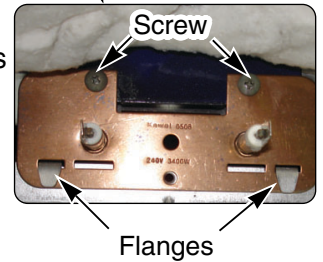

9. Carefully pull the hidden bake element and its mounting bracket out of the range.

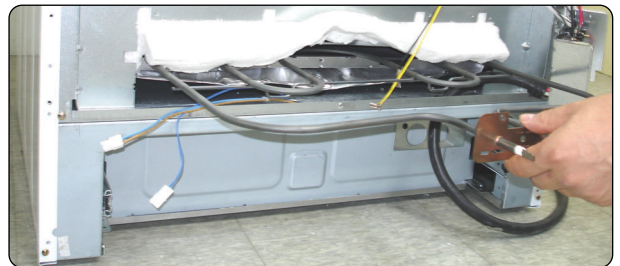

## REPLACING THE MOUNTING BRACKET



1. Drive the two screws

# COMPONENT ACCESS

## REMOVING THE CONVECTION ELEMENT, FAN BLADE AND FAN MOTOR

1. Disconnect power and remove oven racks.
2. Pull the range out of its mounting location so that you can access the rear of the unit.
3. Remove the rear panel from the unit.  
(See step 3~4 on page 3-2 for procedure)
4. Disconnect the wire connection.

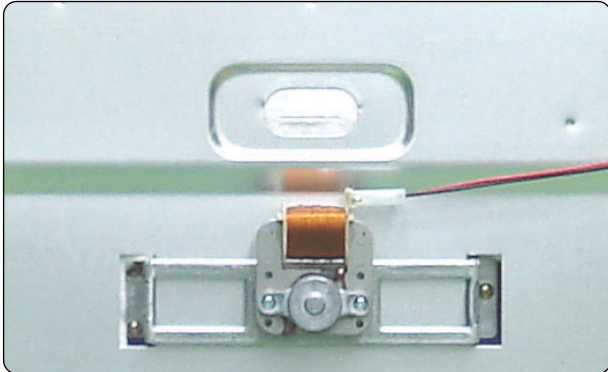

5. Remove the four Fan cover screws and set the fan cover aside.



6. To remove Fan blade, remove Nut by screwing clockwise. Fan blade can be replaced from inside oven.

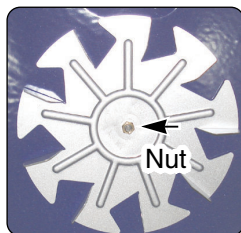

8. To remove Fan motor assembly, disconnect wire connection and remove the three bracket screws
9. Pull the fan motor assembly forward.

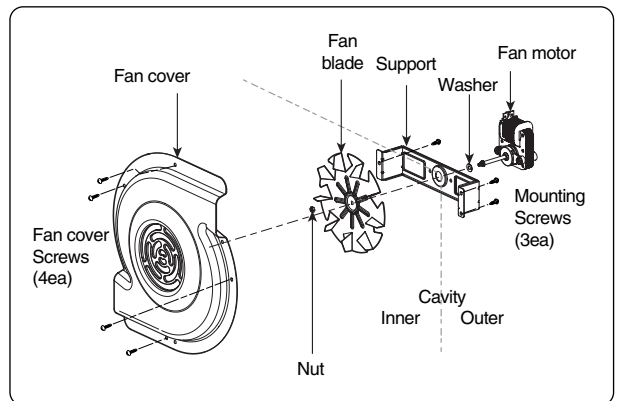
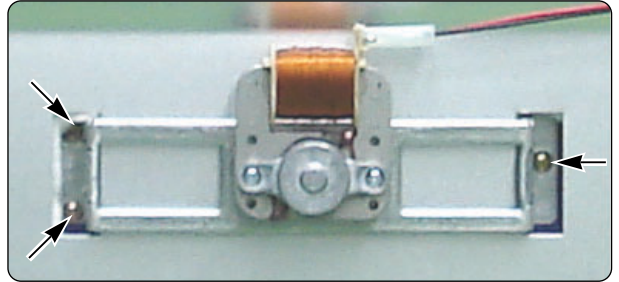

### CAUTION

Be careful not to bend the fan blade.

# COMPONENT ACCESS

## REMOVING THE OVEN LIGHT & SOCKET ASSEMBLY

### **WARNING**

#### **ELECTRICAL SHOCK HAZARD**

Disconnect power before servicing the range.  
Replace all panels before operating range.  
Failure to do so can result in death or electrical shock.

### **CAUTION**

When you work on the electric range, be careful when handling the sheet metal parts. Sharp edges may be present, and you can cut yourself if you are not careful.

#### **To replace:**

1. Unplug range or disconnect power.
2. Turn the glass bulb cover in the back of the oven counterclockwise to remove.
3. Turn bulb counterclockwise to remove from socket.
4. Replace bulb and bulb cover by turning clockwise.

Glass cover & Bulb

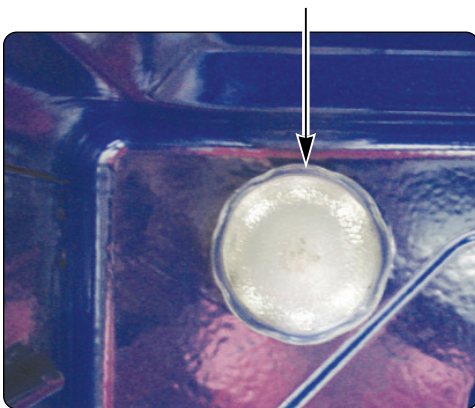

### **CAUTION**

Be careful not to scratch or chip the oven liner paint when you remove the oven light socket in the next step.

5. Use a screwdriver and bend the clips on the oven light socket away from the edges of the liner hole, and pull the socket out of the liner.  
NOTE: If it is too difficult to remove the socket from the front of the oven, you will have to push the socket out from the back of the unit.

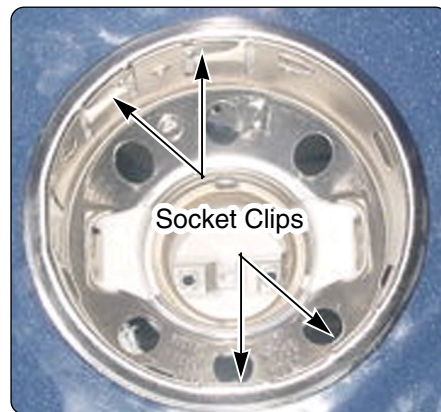

5. Disconnect the wires from the socket terminals.

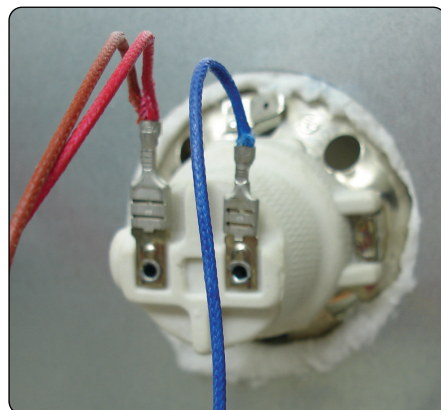

<Viewed From Rear Panel>

# COMPONENT ACCESS

## REMOVING THE LATCH DRIVE ASSEMBLY

### WARNING

#### **ELECTRICAL SHOCK HAZARD**

Disconnect power before servicing the range.  
Replace all panels before operating range.  
Failure to do so can result in death or electrical shock.

### CAUTION

When you work on the electric range, be careful when handling the sheet metal parts. Sharp edges may be present, and you can cut yourself if you are not careful.

1. Turn off the electrical supply going to the range.
2. Pull the range away from the wall so that you can access the rear panel.
3. Remove the back cover & control cover (see step 3~4 on page 3-2).
4. Disconnect the wires from the latch drive motor and switch.
5. Remove the two mounting screws from the latch drive.

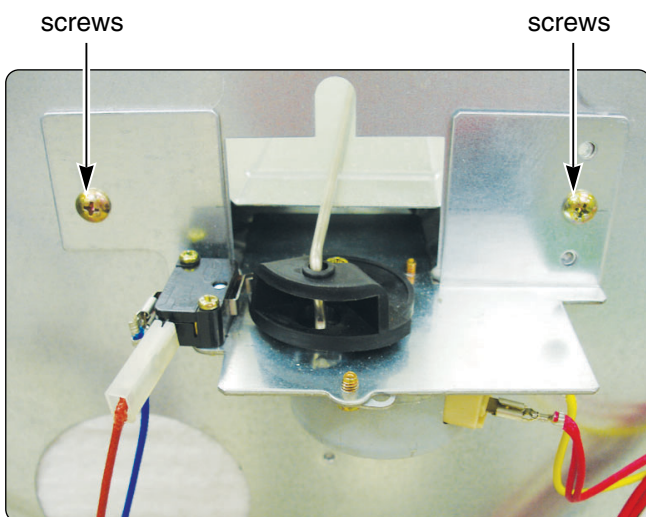

6. Unhook the Latch rod from the cam.

### DOOR LOCKING MECHANISM

The door lock assembly is located at the back side of range.

The structural elements are as below.

1. When the oven control is programmed and started for the Self clean and Lock out mode, PCB (Power control board) chip operates the motor.

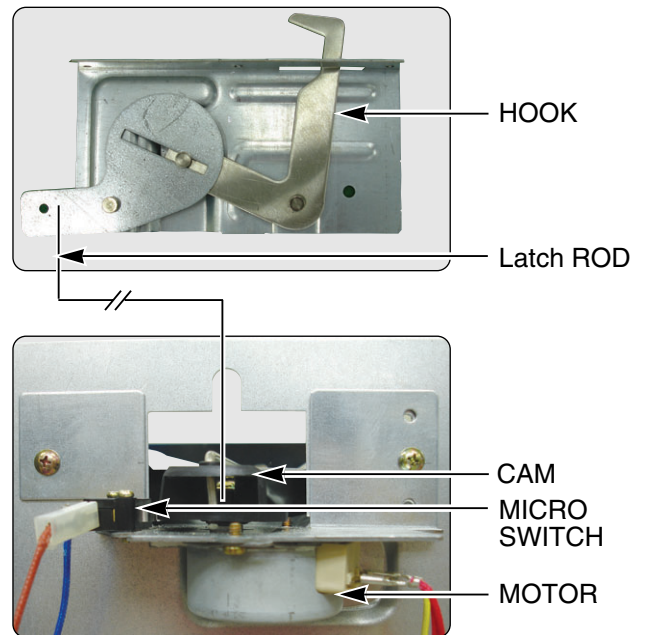

2. The cam moves the door hook connected to latch rod from unlocked position to locked position (from locked Position to unlocked position)
3. The cam activates the micro switch that causes the motor to stop.
4. The locked status remains until the range temperature drops to approximately 500F after end of the self clean or lock out feature is reactivated. The motor operates to unlock door at that time.

# COMPONENT ACCESS

## REMOVING THE OVEN TEMPERATURE SENSORS

### **WARNING**

#### **ELECTRICAL SHOCK HAZARD**

Disconnect power before servicing the range.  
Replace all panels before operating range.  
Failure to do so can result in death or electrical shock.

### **CAUTION**

When you work on the electric range, be careful when handling the sheet metal parts. Sharp edges may be present, and you can cut yourself if you are not careful.

1. Turn off the electrical supply going to the range.
2. Open the oven door and remove the racks from the oven.
3. Pull the range away from the wall so that you can access the rear panel.
4. Remove the 16 screws from the rear panel and remove the panel (see step 3 on page 3-2).

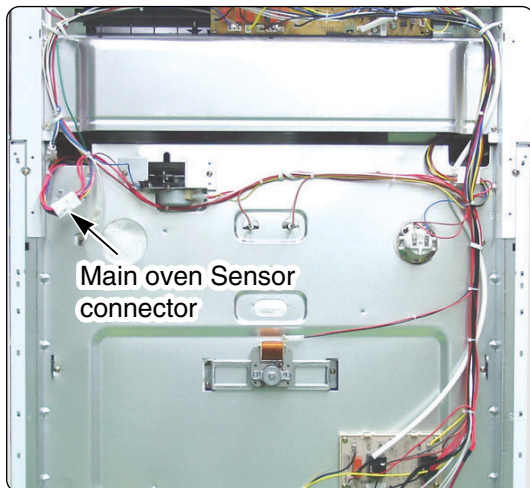

5. To remove an oven temperature sensor, disconnect the connector from the main harness and remove the two mounting screws in oven cavity.

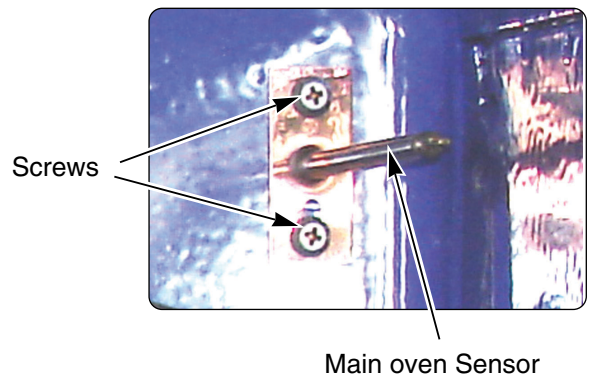

# COMPONENT ACCESS

## REMOVING THE STORAGE DRAWER

### **WARNING**

#### **ELECTRICAL SHOCK HAZARD**

Disconnect power before servicing the range.  
Replace all panels before operating range.  
Failure to do so can result in death or electrical shock.

### **CAUTION**

When you work on the electric range, be careful when handling the sheet metal parts. Sharp edges may be present, and you can cut yourself if you are not careful.

#### **To Replace the Storage Drawer:**

1. Replace shield on the right glide of the drawer body.
2. Pull the bearing glides to the front of the chassis glide.
3. Align the glide on each side of the drawer with the glide slots on the range.
4. Push the drawer into the range until levers “click” (approximately 2”). Pull the drawer open again to seat bearing glides into position. If you do not hear the levers “click” or the bearing glides do not feel seated remove the drawer and repeat steps 2-4. This will minimize possible damage to the bearing glides.

#### **To Remove Storage Drawer:**

1. **CAUTION** - Turn power OFF before removing the Storage Drawer.
2. Open the drawer to the fully opened position.
3. Remove the 2 screws (right and left side). (refer to below picture)
4. Locate glide lever on each side of drawer, push down on the left glide lever and pull up on the right glide lever.

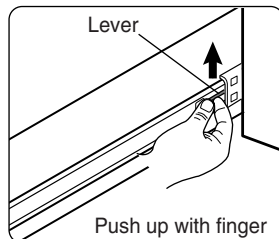
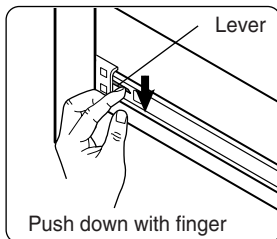
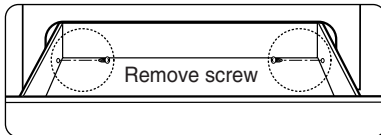

5. Pull the Storage drawer away from the range.

# COMPONENT ACCESS

## REMOVING & REPLACING THE LIFT-OFF OVEN DOOR

### CAUTION

The door is very heavy. **Be careful** when removing and lifting the door. **Do not** lift the door by the handle.

### To remove the door:

#### Step. 1

Fully open the door.

#### Step. 2

Pull the hinge locks down toward (Fig.1) the door frame, to the unlocked position.

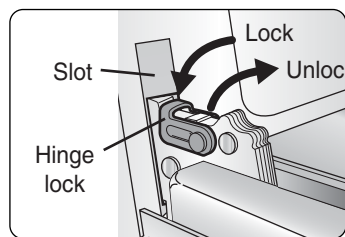

<Fig.1>

#### Step. 3

Firmly grasp both sides of the door at the top.

#### Step. 4

Close door to the door removal position, which is approximately 5 degrees. (refer to the Fig.2)

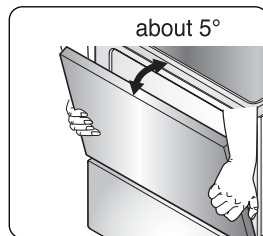

<Fig.2>

#### Step. 5

Lift door up and out until the hinge arm is clear of the slot.

### To replace the door:

#### Step. 1

Firmly grasp both sides of the door at the top.

#### Step. 2

With the door at the same angle as the removal position, seat the indentation of the hinge arm into the bottom edge of the hinge slot. The notch in the hinge arm must be fully seated into the bottom of the slot.

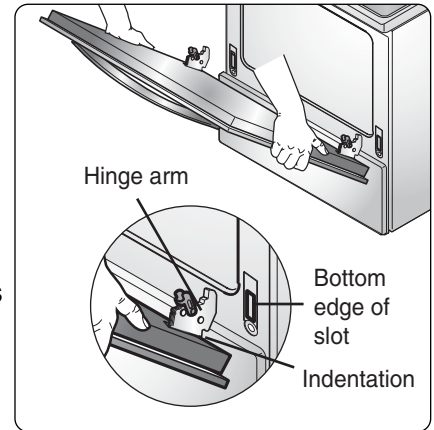

#### Step. 3

Fully open the door. If the door will not fully open, the indentation is not seated correctly in the bottom edge of the slot.

#### Step. 4

Push the hinge locks up against the front frame of the oven cavity to the locked position.

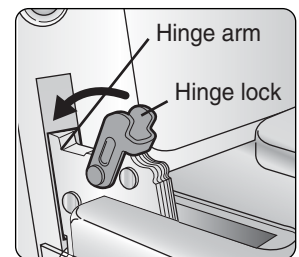

#### Step. 5

Close the oven door.

# COMPONENT ACCESS

## REMOVING THE OVEN DOOR HANDLE & GLASS

### **⚠ WARNING**

#### **ELECTRICAL SHOCK HAZARD**

Disconnect power before servicing the range.  
Replace all panels before operating range.  
Failure to do so can result in death or electrical shock.

### **⚠ CAUTION**

When you work on the electric range, be careful when handling the sheet metal parts. Sharp edges may be present, and you can cut yourself if you are not careful.

1. Remove the oven door from the range (see page 3-13 for the procedure).
2. Place the oven door on a padded work surface with the front glass facing down.
3. Remove the 4 top door screws.

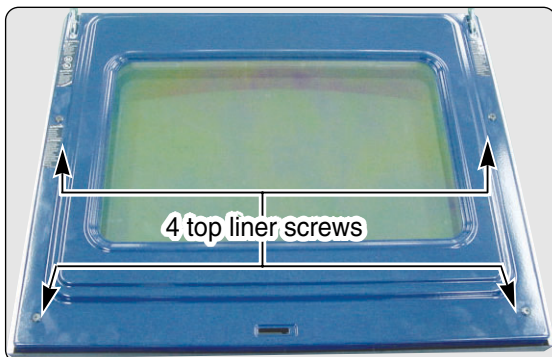

4. Remove the three bottom screws from the door liner.

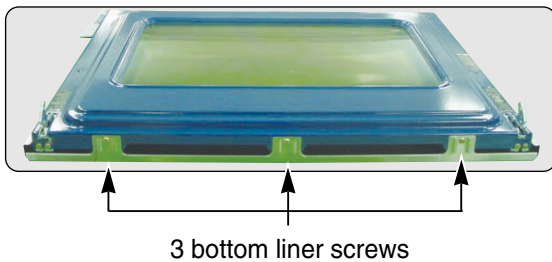

5. Lift the liner assembly off the front glass and set it aside.

Copyright © 2007 LG Electronics, Inc. All right reserved.  
Only for training and service purposes

6. To remove the door handle & trim (for stainless model)  
a) Remove the 4 door handle screws and lift the door handle off door trim and slide up the door handle.

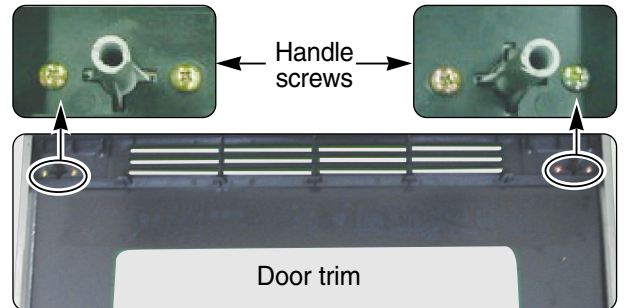

6. To remove the door handle trim & glass (for white / Black model)

- a) Remove the handle and glass trim screws

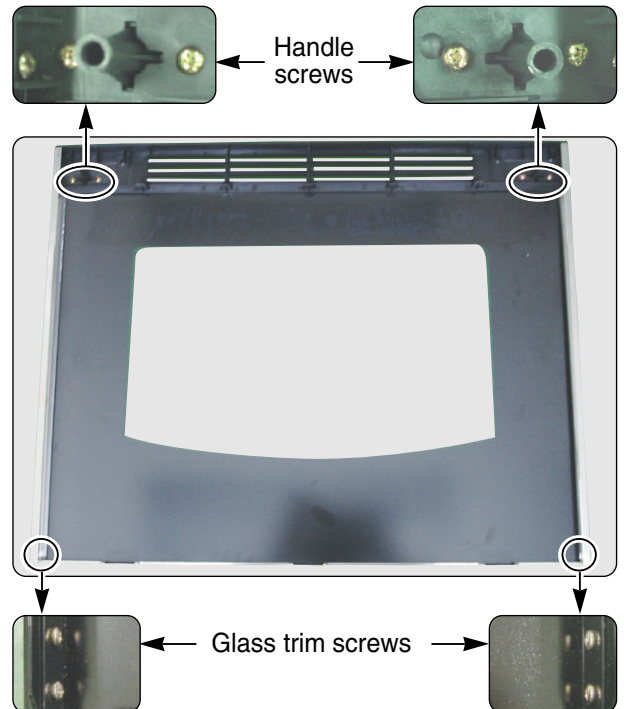

- b) Lift the door handle off door trim

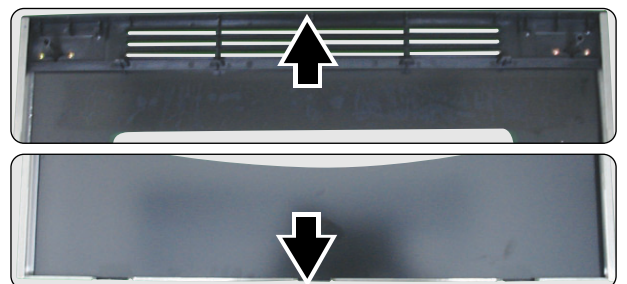

- c) Slide up the door trim and pull the glass trim forward

# COMPONENT ACCESS

## 7. To remove a hinge hanger assembly:

- Remove the 2 top liner screws  
(See step 3 on page 3-14)
- Place the door liner assembly on a padded work surface with the hinge hangers over the edge.
- Remove the two bottom screws.
- Lift the hinge hanger out of the door liner slot.

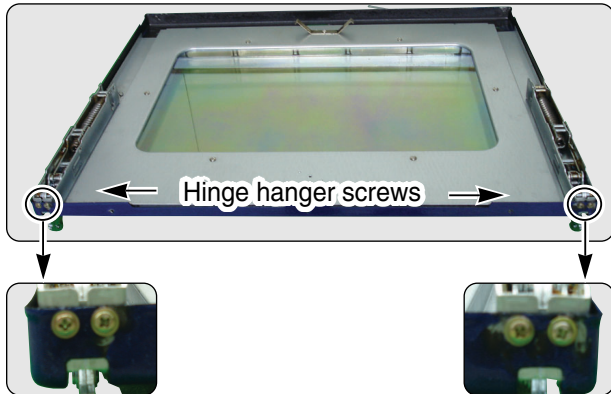

- Lift the inner oven door glass and bracket assembly out of the door liner.



**REASSEMBLY NOTE:** When you reinstall the insulation around the oven door glass, make sure that the insulation is not visible in the glass after the door is reassembled.

## 8. To remove the oven door glass assembly:

- Remove both hinge hangers (see step 8).
- Remove the 6 screws.
- Lift the insulation cover off the door liner.

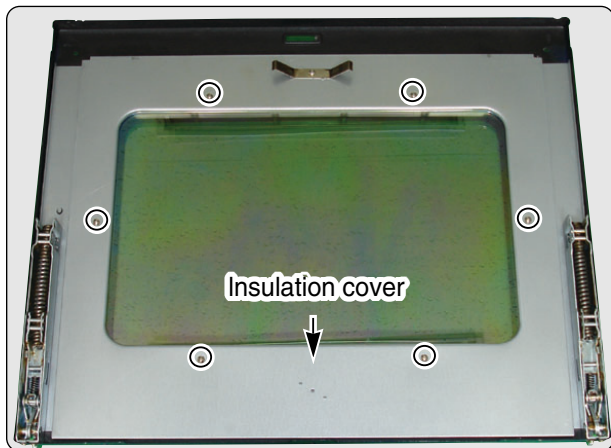

# COMPONENT ACCESS

## REMOVING THE OVEN DOOR GASKET

### **WARNING**

#### **ELECTRICAL SHOCK HAZARD**

Disconnect power before servicing the range.  
Replace all panels before operating range.  
Failure to do so can result in death or electrical shock.

### **CAUTION**

When you work on the electric range, be careful when handling the sheet metal parts. Sharp edges may be present, and you can cut yourself if you are not careful.

1. Open the oven door to its fully down position.
2. Pull the oven door gasket clips out of the liner holes until all of the clips are removed.

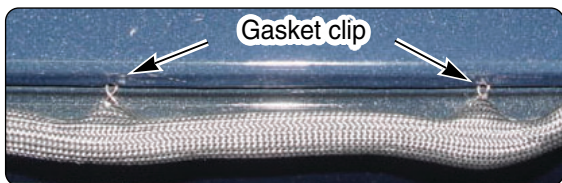
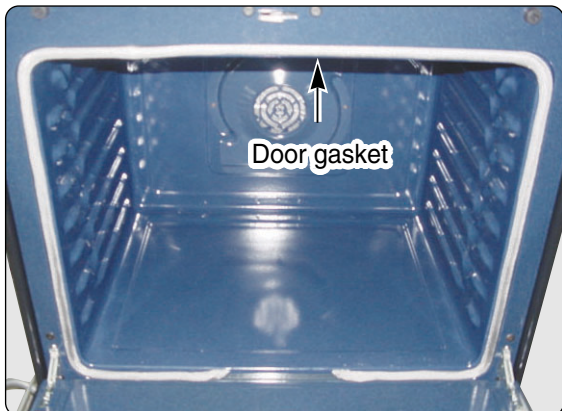

3. Pull the ends of the gasket out of the liner holes.

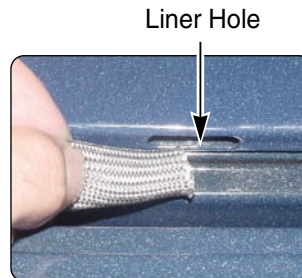

**REASSEMBLY NOTE:** When you install the new gasket, make sure that all of the clips are seated in their liner holes, and that the ends of the gasket are pushed fully into their holes. Use the pointed end of a pencil to push the gasket ends into the holes.

# COMPONENT ACCESS

## REMOVING A SIDE PANEL

### WARNING

#### **ELECTRICAL SHOCK HAZARD**

Disconnect power before servicing the range.  
Replace all panels before operating range.  
Failure to do so can result in death or electrical shock.

### CAUTION

When you work on the electric range, be careful when handling the sheet metal parts. Sharp edges may be present, and you can cut yourself if you are not careful.

1. Turn off the electrical supply going to the range.
2. Remove the oven door from the range (see page 3-13 for the procedure).
3. Pull the range away from the wall so you can access the back of the unit.
4. Remove the 16 screws from the rear panel and remove the panel (see step 3~4 on page 3-2).
5. Raise the cooktop (see page 3-4 for the procedure). NOTE: Position the side of the cooktop so that it does not rest on the side panel that you are removing.
6. Remove the two screws from the top rear of the side panel.



7. Remove the two screws from the left or right side panel.

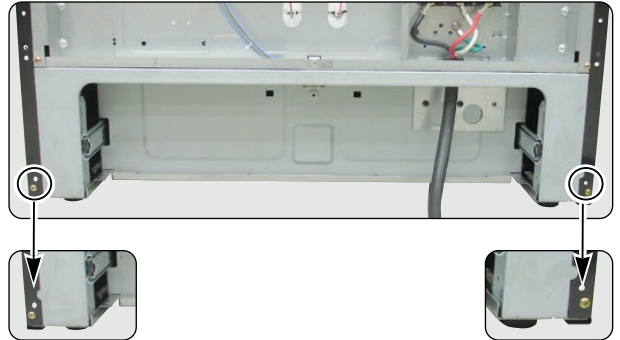

8. Pull the back of the side panel out from the range approximately 10°.

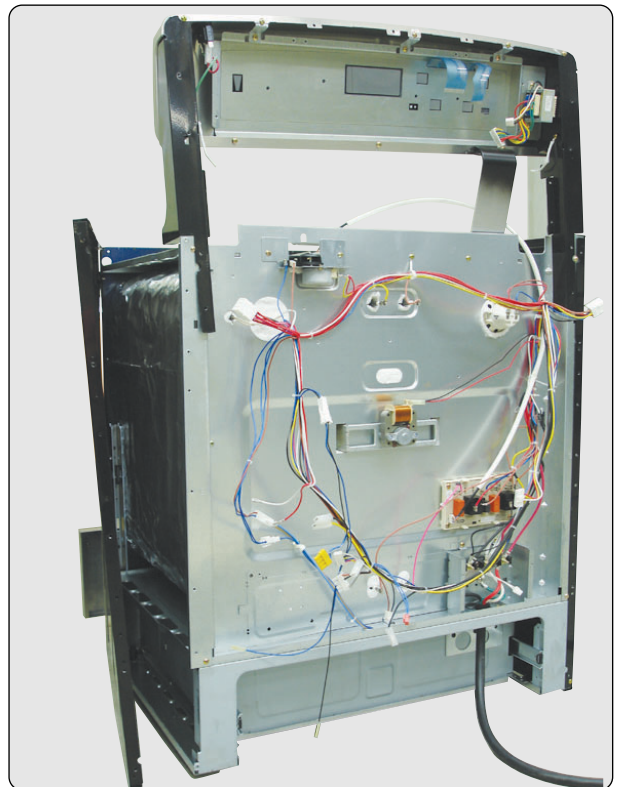

9. Push forward and remove the side panel.

# COMPONENT TEST

**Before testing any of components, perform the following checks:**

**NOTE:**

1. The most common cause for control failure is corrosion on connectors.  
Therefore, disconnecting and reconnecting wires will be necessary throughout test procedures
2. ALL units in the first few days of use should be checked for mis-wiring or loose connections



1. All/tests/checks should be made with a VOM or DVM having a sensitivity of 20,000 ohms per-volt DC, or greater.
2. Check all connections before replacing components, looking for broken or loose wires, Failed terminals, or wires not pressed into connectors far enough.
3. Resistance checks must be made with power cord unplugged from outlet, and with wiring harness or connectors disconnected.





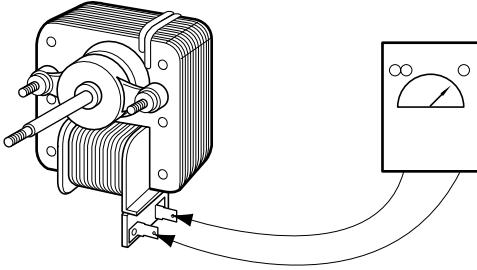

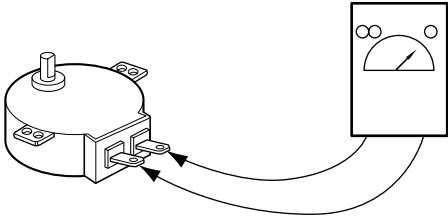
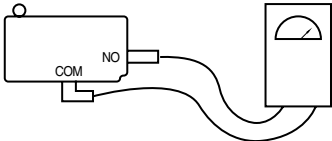
**⚠ WARNING**

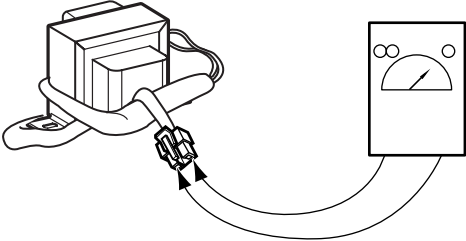
- Disconnect power supply cord from the outlet before servicing
  - Replace all panels and parts before operating
  - Reconnect all grounding devices after servicing
- Failure to do so can result in death or electrical shock

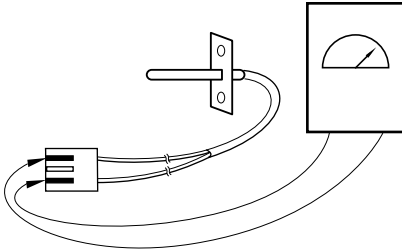
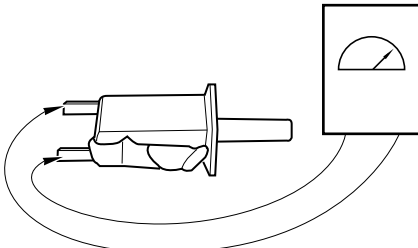
**NOTE: Below  $\Omega$  value were tested at room temperature (77F/25°C)**

Components	Test procedures	Results
<p>Convection Motor</p>	<ol style="list-style-type: none"> <li>1. Refer to page 3-8 for the servicing procedure</li> <li>2. Measure the resistance (Multiple meter scale: R x 1)</li> </ol> 	<p>Normal: Approximately <math>33.5 \Omega \pm 10\%</math> If not replace</p> <p>Abnormal: Infinite (open) below <math>5\Omega</math> (shorted)</p>

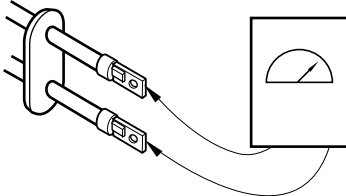
Components	Test procedures	Results	
Door locking Motor	1. Refer to page 3-10 for the servicing procedure 2. Measure the resistance (Multiple meter scale: R x 1000)  	Normal: Approximately $2.6\text{ k}\Omega \pm 10\%$ If not replace Abnormal: Infinite(open) below $5\Omega$ (shorted)	
Micro Switch (normally open type)	1. Refer to page 3-10 for the servicing procedure 2. Measure the resistance (Multiple meter scale: R x 1000)  	Door latch open	Door latch Locked
		 Continuity	 Infinite
NOTE: After checking for the continuity of switch, make sure that they are connected correctly			
LVT	1. Refer to page 3-3 for the servicing procedure 2. Measure the resistance (Multiple meter scale: R x 1000)  	Normal: Approximately $27\ \Omega \pm 10\%$ If not replace	

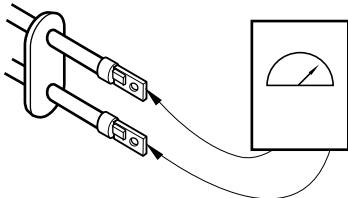
Components	Test procedures	Results	
Oven Sensor	1. Refer to page 3-11 for the servicing procedure 2. Measure the resistance after cooling down (Multiple meter scale: R x 1000) 	Normal: Approximately $1.09\text{ k}\Omega \pm 10\%$ If not replace  <b>NOTE:</b> $\Omega$ Value was tested at room temperature (77F/25°C)	
<b>NOTE:</b> Oven sensor is so sensitive to temperature Do test after cooling down sufficiently			
Door switch	1. Refer to page 3-5 for the servicing procedure 2. Measure the resistance after cooling down (Multiple meter scale: R x 1000) 	Door open	Door closed
		 Continuity	 Infinite
Broil element 	1. Refer to page 3-6 for the servicing procedure 2. Measure the resistance after cooling down (Multiple meter scale: R x1) 	Normal: Approximately $14\ \Omega \pm 10\%$ If not replace  <b>NOTE:</b> $\Omega$ Value was tested at room temperature (77F/25°C) Be careful the element is sensitive to temperature.	
Bake element 	1. Refer to page 3-7 for the servicing procedure 2. Measure the resistance after cooling down (Multiple meter scale: R x1) 	Normal: Approximately $17\ \Omega \pm 10\%$ If not replace  <b>NOTE:</b> $\Omega$ Value was tested at room temperature (77F/25°C) Be careful the element is sensitive to temperature.	

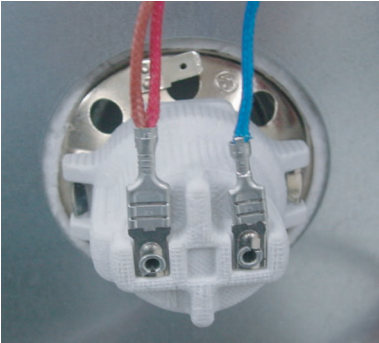
Components	Test procedures	Results
Oven lamp	<p>1. Measure the resistance after cooling down (Multiple meter scale: R x1)</p> 	<p>Normal: Below 5 Ω. If not replace</p>

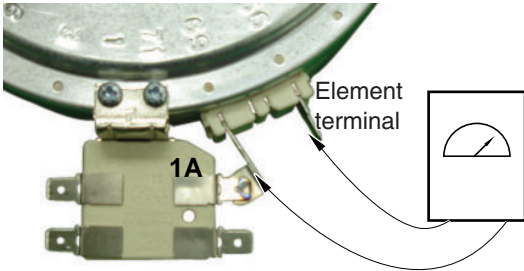
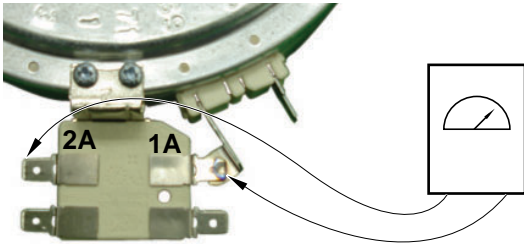
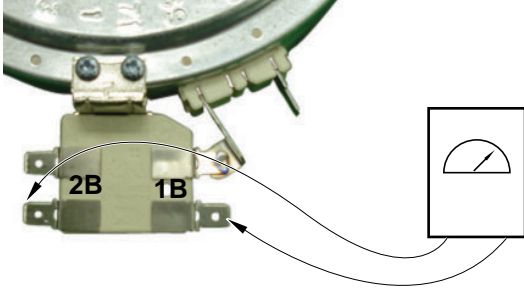
Components	Test procedures	Results
<p><b>Single surface units:</b> Right Front (RF), Left Rear (LR) and Right Rear(RR) Element</p>	<p>1. Refer to page 3-4 for the servicing procedure</p> <p>2. Set the Multiple meter scale to the R x 1</p> <p>3. Disconnect wires from cook-top elements</p> <p>4. Touch the ohmmeter test leads to the element terminal and 1A. The meter should indicate <math>46 \Omega \pm 10\%</math></p>  <p>5. Touch the ohmmeter test leads to limiter terminals 1A and 2A. The meter should indicate continuity.(0Ω)</p>  <p>6. Touch the ohmmeter test leads to limiter terminals 1B and 2B. With the temperature below 150°F, the meter should indicate an open circuit(infinite). With the temperature above 150°F, the meter should indicate continuity (0Ω).</p> 	<p>Normal: Approximately <math>46 \Omega</math>, If not replace</p> <p>Normal: continuity (below <math>0.5 \Omega</math>) If not replace</p> <p>Below 150°F → open circuit(infinite).</p> <p>Above 150°F → continuity (<math>0 \Omega</math>)</p>

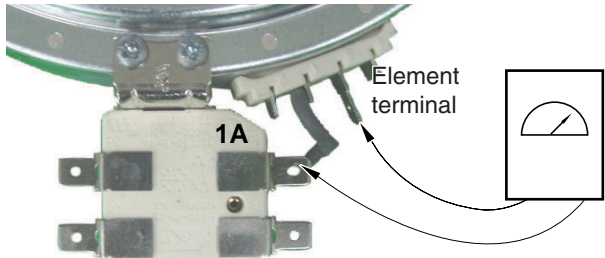
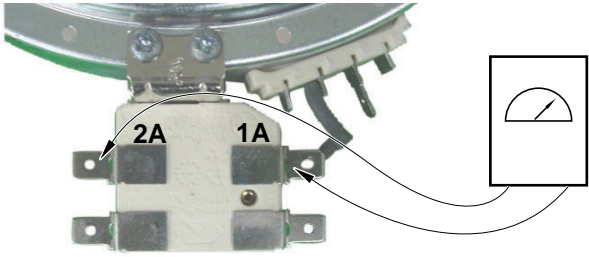
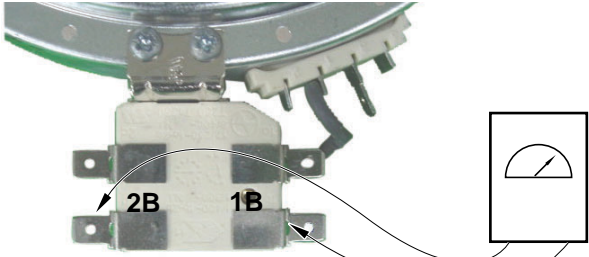
Components	Test procedures	Results
Center Rear(CR) Element <b>;Warming Zone</b>	<ol style="list-style-type: none"> <li>1. Refer to page 3-4 for the servicing procedure</li> <li>2. Set the Multiple meter scale to the R x 1</li> <li>3. Disconnect wires from CR elements</li> <li>4. Touch the ohmmeter test leads to the element terminal and 1A. The meter should indicate <math>565 \Omega \pm 10\%</math></li> </ol>  <ol style="list-style-type: none"> <li>5. Touch the ohmmeter test leads to limiter terminals 1A and 2A. the meter should indicate continuity (<math>0 \Omega</math>)</li> </ol>  <ol style="list-style-type: none"> <li>6. Touch the ohmmeter test leads to limiter terminals 1B and 2B.            With the temperature below <math>150^{\circ}\text{F}</math>, the meter should indicate an open circuit(infinite).            With the temperature above <math>150^{\circ}\text{F}</math>, the meter should indicate continuity (<math>0 \Omega</math>).</li> </ol> 	<p>Normal: Approximately <math>565 \Omega</math>, If not replace</p> <p>Normal: continuity (below <math>0.5 \Omega</math>) If not replace</p> <p>Below <math>150^{\circ}\text{F}</math> → open circuit(infinite).</p> <p>Above <math>150^{\circ}\text{F}</math> → continuity (<math>0 \Omega</math>)</p>

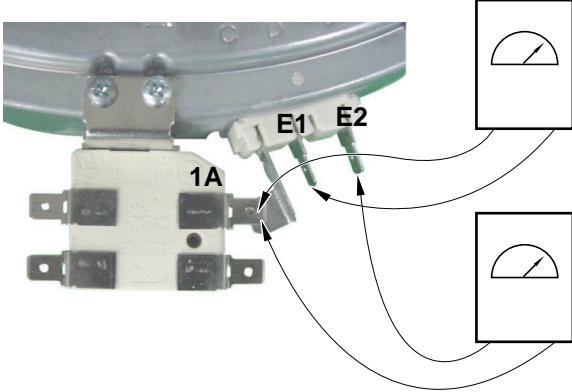
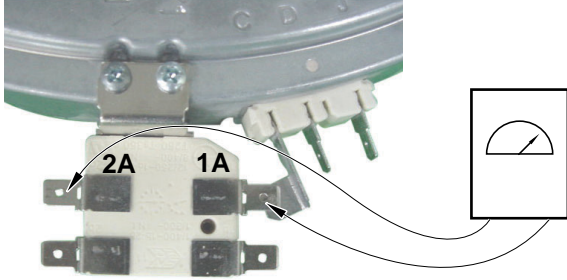
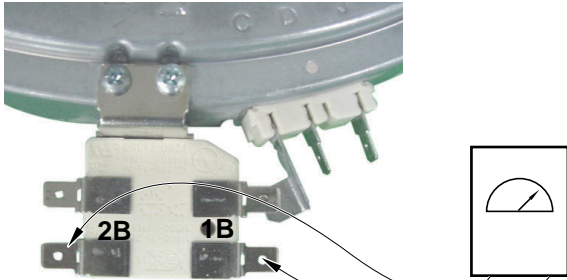
Components	Test procedures	Results
Dual surface element : Left Front(LF)	<ol style="list-style-type: none"> <li>Refer to page 3-4 for the servicing procedure</li> <li>Set the Multiple meter scale to the R x1</li> <li>Disconnect wires from cook-top elements</li> <li>Touch the ohmmeter test leads to the (E1 &amp; 1A) and (E2 &amp; 1A) the meter should indicate :               <ul style="list-style-type: none"> <li>- (E1 &amp; 1A) → <math>32 \Omega \pm 10\%</math></li> <li>- (E2 &amp; 1A) → <math>55 \Omega \pm 10\%</math></li> </ul> </li> </ol>  <ol style="list-style-type: none"> <li>Touch the ohmmeter test leads to limiter terminals 1A and 2A.the meter should indicate continuity (<math>0 \Omega</math>)</li> </ol>  <ol style="list-style-type: none"> <li>Touch the ohmmeter test leads to limiter terminals 1B and 2B.                With the temperature below <math>150^\circ\text{F}</math>, the meter should indicate an open circuit(infinite).                With the temperature above <math>150^\circ\text{F}</math>, the meter should indicate continuity (<math>0 \Omega</math>).</li> </ol> 	<p>Normal: Approximately <math>32 \Omega</math></p> <p>Normal: Approximately <math>55 \Omega</math></p> <p>Normal: continuity (below <math>0.5 \Omega</math>) If not replace</p> <p>Below <math>150^\circ\text{F}</math> → open circuit(infinite).</p> <p>Above <math>150^\circ\text{F}</math> → continuity (<math>0 \Omega</math>)</p>

# COMPOSITION OF CONTROL

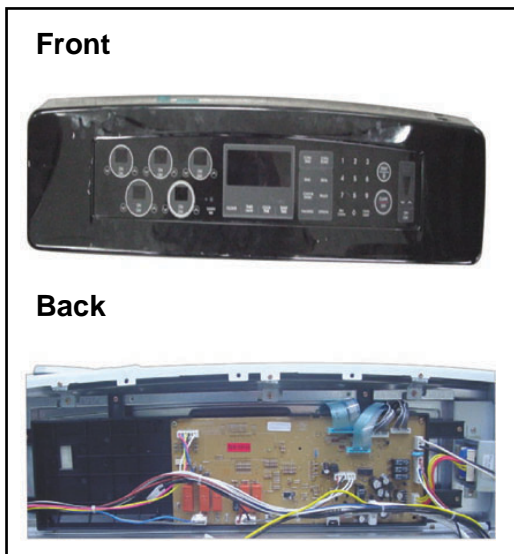

**Controller assembly**



**Key pad assembly**

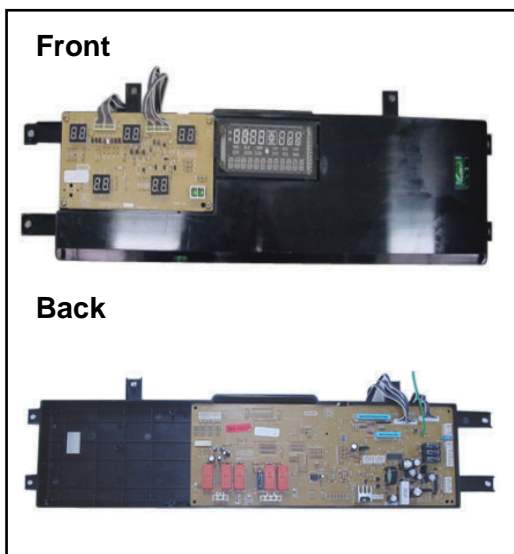

**PCB case assembly**

**Main PCB (P/N : 6871W1N002A)**



**Front**

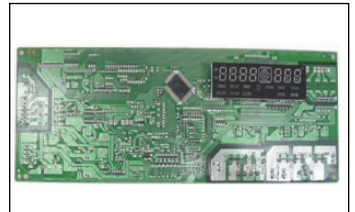

**Back**

**Cook top display PCB (P/N : 6871W1N010B)**

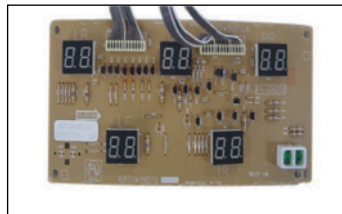

**Front**

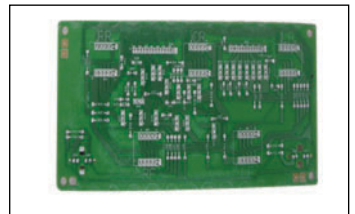

**Back**

**Oven relay PCB (P/N : 6871W1N012B)**



**Front**

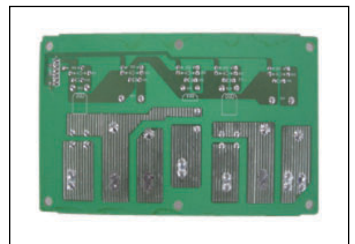

**Back**

# COMPOSITION OF CONTROL

## Main PCB

P/N : 6871W1N002A

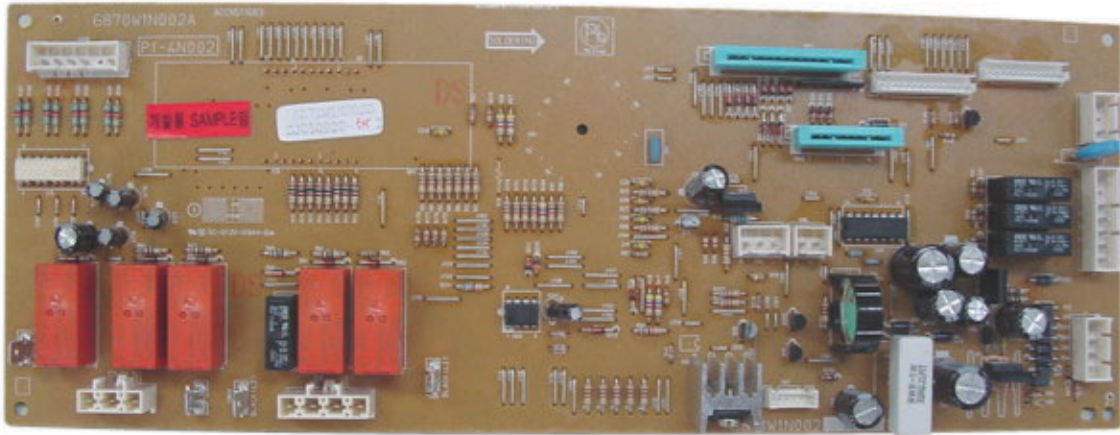

### Main function

- ▶ Supply a DC power source (GND,5V,12V(Vry(oven heater switching)),Vdisp(5V))
- ▶ Supply a DC power source (GND,12V(Vry(cooktop heater switching voltage))
- ▶ Oven heater control (DLB / Broil / Bake)
- ▶ Oven display control
- ▶ Cook top heater control (Warmer zone / RR / LR / RF / LF)
- ▶ Cook top display control
- ▶ Oven lamp / door lock motor / convection fan control
- ▶ Detecting oven temperature / warming drawer temperature
- ▶ Buzzer sound control
- ▶ Key entry
- ▶ Door open/close, Door lock/unlock detection
- ▶ Error mode detection and pop up
- ▶ Supervising hot cook top element
- ▶ Single Radiant Surface Elements -Right Rear, Left Rear, Left Front- on/off, power level relay switching
- ▶ Dual Radiant Surface Elements -Right Front INNER, OUTER- on/off, power level relay switching
- ▶ Single Radiant Surface Elements -Warming Zone (Center Rear)-on/off,power level relay switching
- ▶ Supervising cook top element hot

# COMPOSITION OF CONTROL

## Cook-top display PCB

P/N : 6871W1N010B

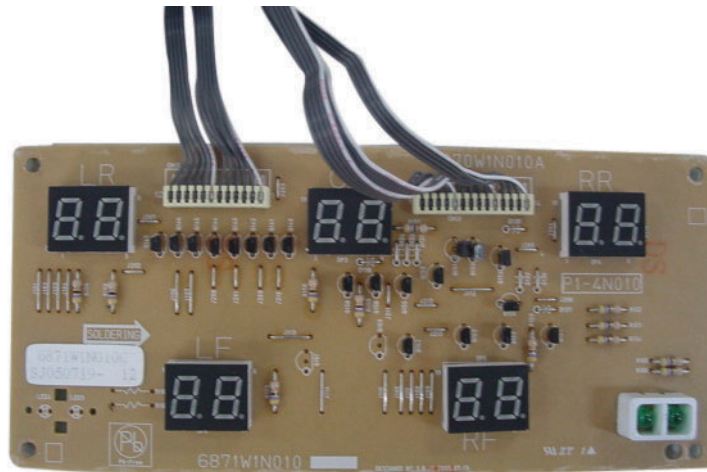

### Main function

- ▶ Single radiant surface elements -Right Rear, Left Rear, Left Front- power level indication
- ▶ Dual radiant surface elements -Right Front inner,outer- power level indication
- ▶ Dual radiant surface element size indication-Right Front inner, outer
- ▶ Single radiant surface elements -warming zone (Center Rear)-power level indication

## Oven relay PCB

P/N : 6871W1N012B

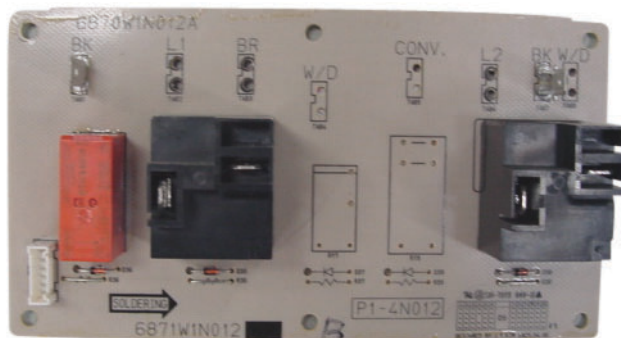

### Main function

- ▶ Oven heater on/off relay switching (DLB / Broil / Bake)

# FAILURE MODE FLOW CHART

## No display (No power)

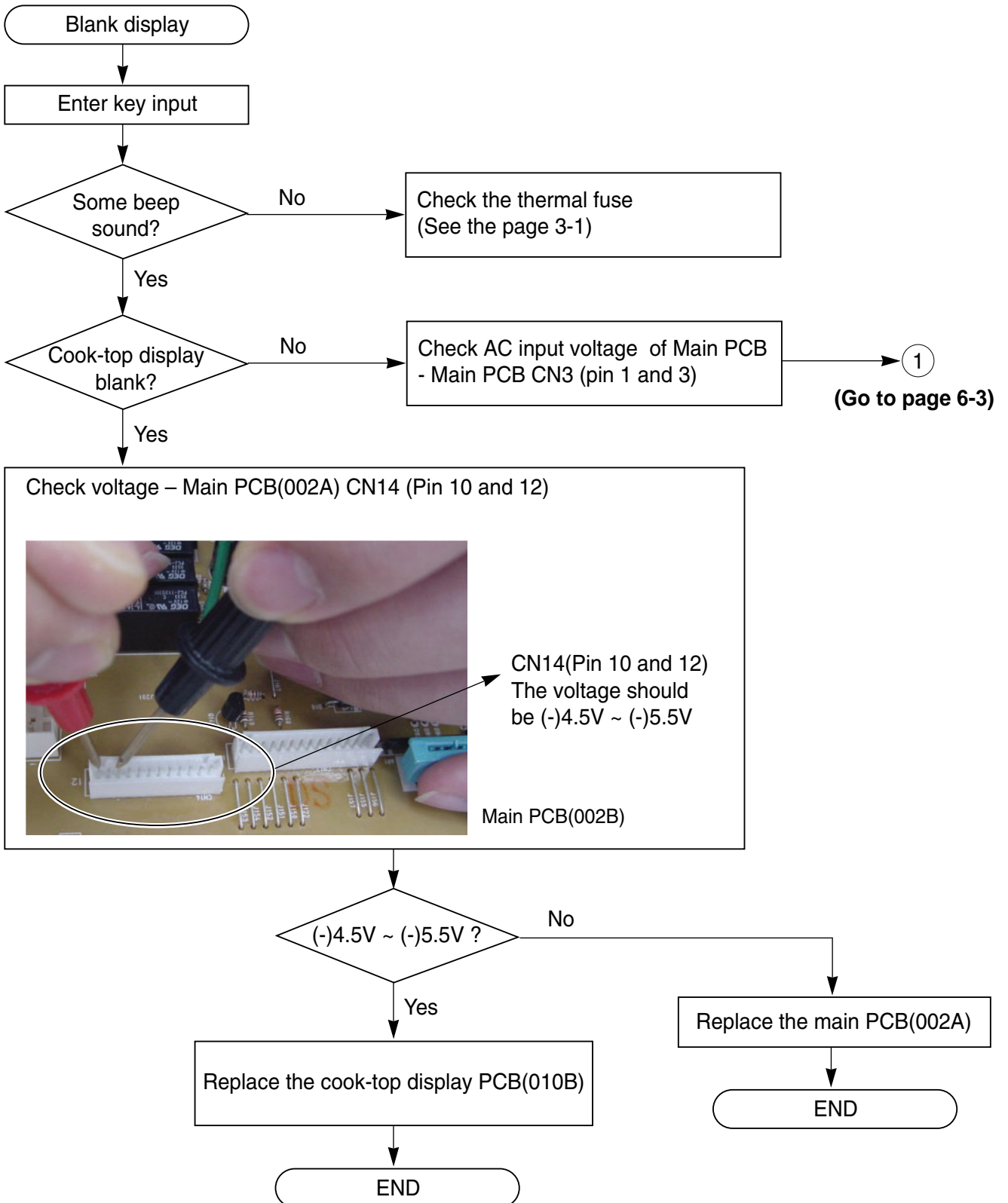

# FAILURE MODE FLOW CHART

## No display (No power)

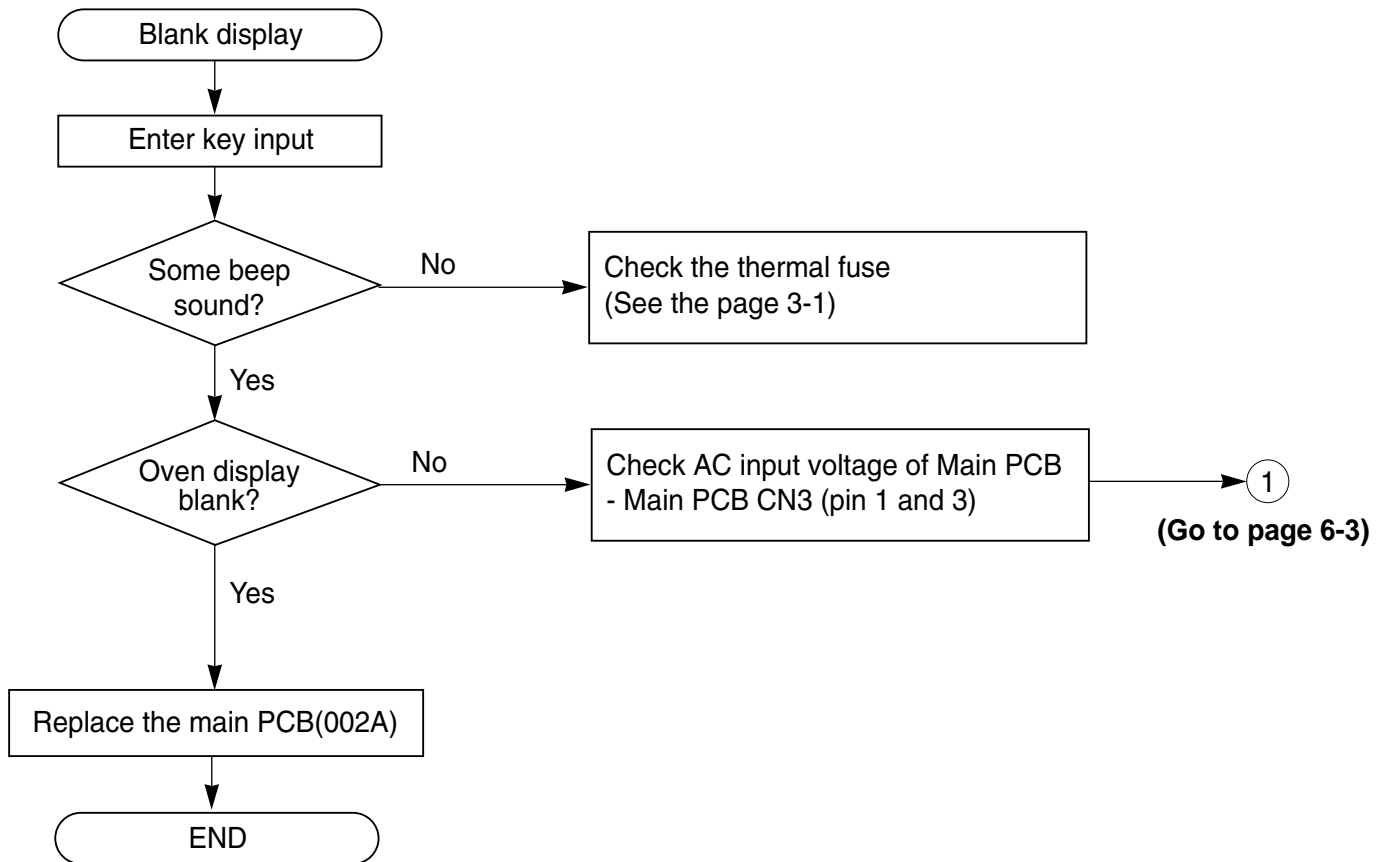

# FAILURE MODE FLOW CHART

## No display (No power)

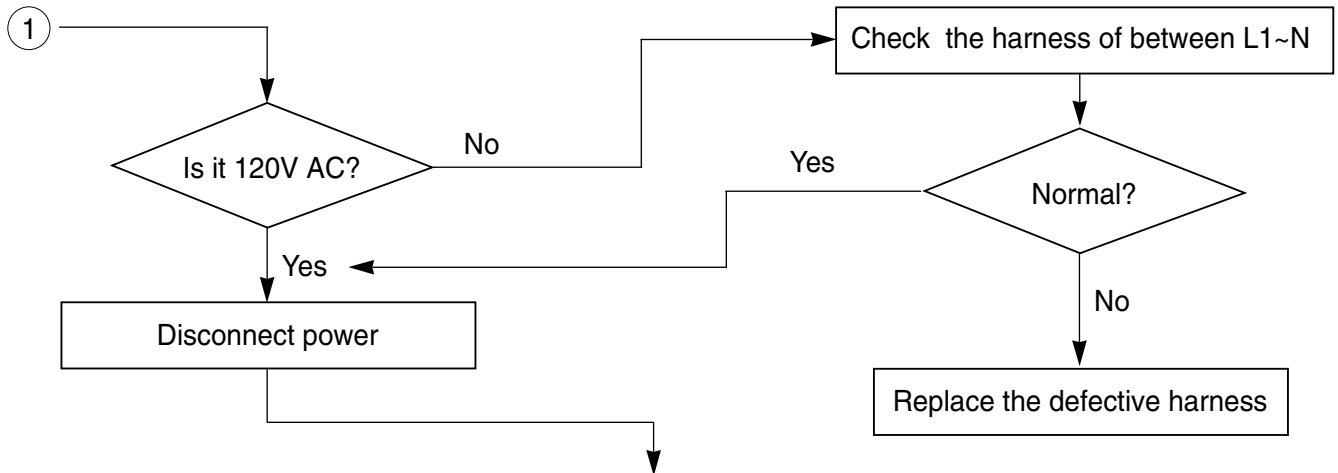

Check the power transformer (Refer to the below)

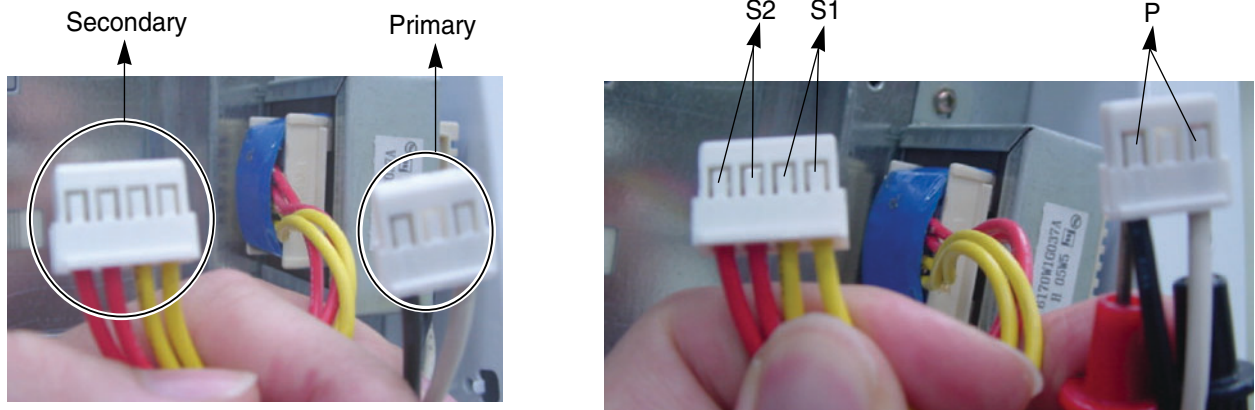
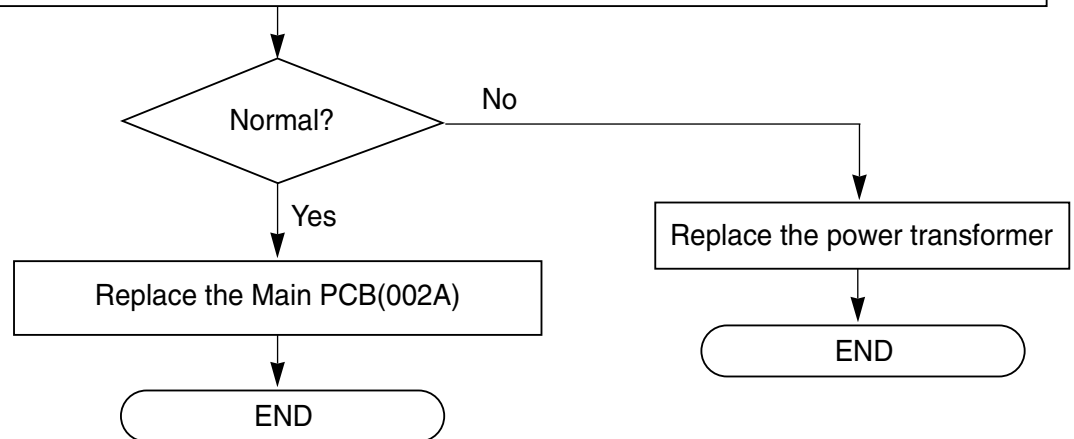

Fig.1

Side	Lead Color	DCR( $\Omega$ )
P	black ~ white	25 ~ 28
S1	yellow ~ yellow	1.0 ~ 1.3
S2	red ~ red	1.8 ~ 2.1

measure LVT coil resistance  
(Normal: approximately Fig1)



# FAILURE MODE FLOW CHART

## Oven does not heat

Code	Error mode	Operation	Times/sampling
F-7	No heating	If current oven temperature does not exceed 150°F and less than start temperature over 5 minutes on preheating, where door is closed. (except proof and cook & warm )	During cook

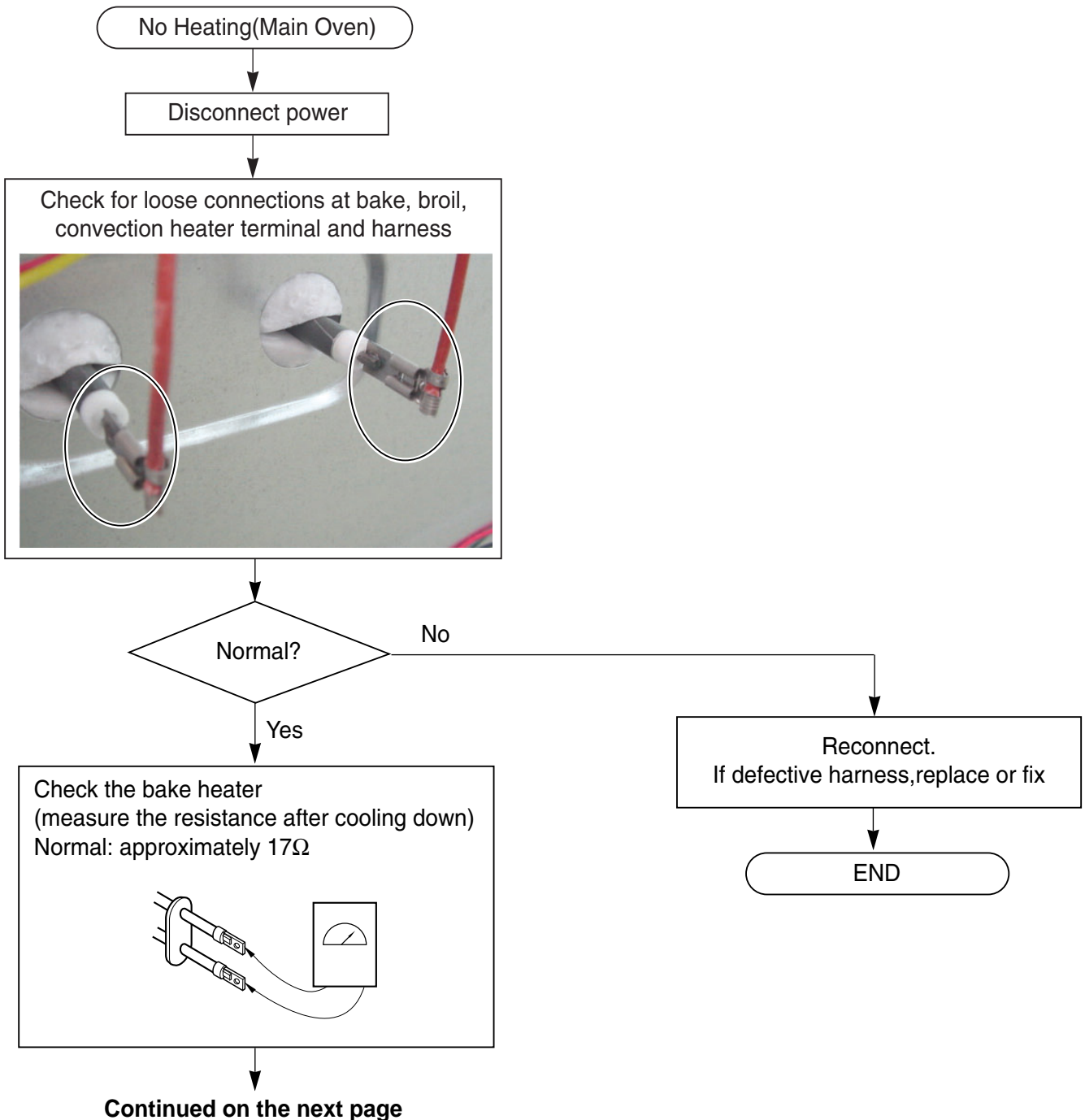

# FAILURE MODE FLOW CHART

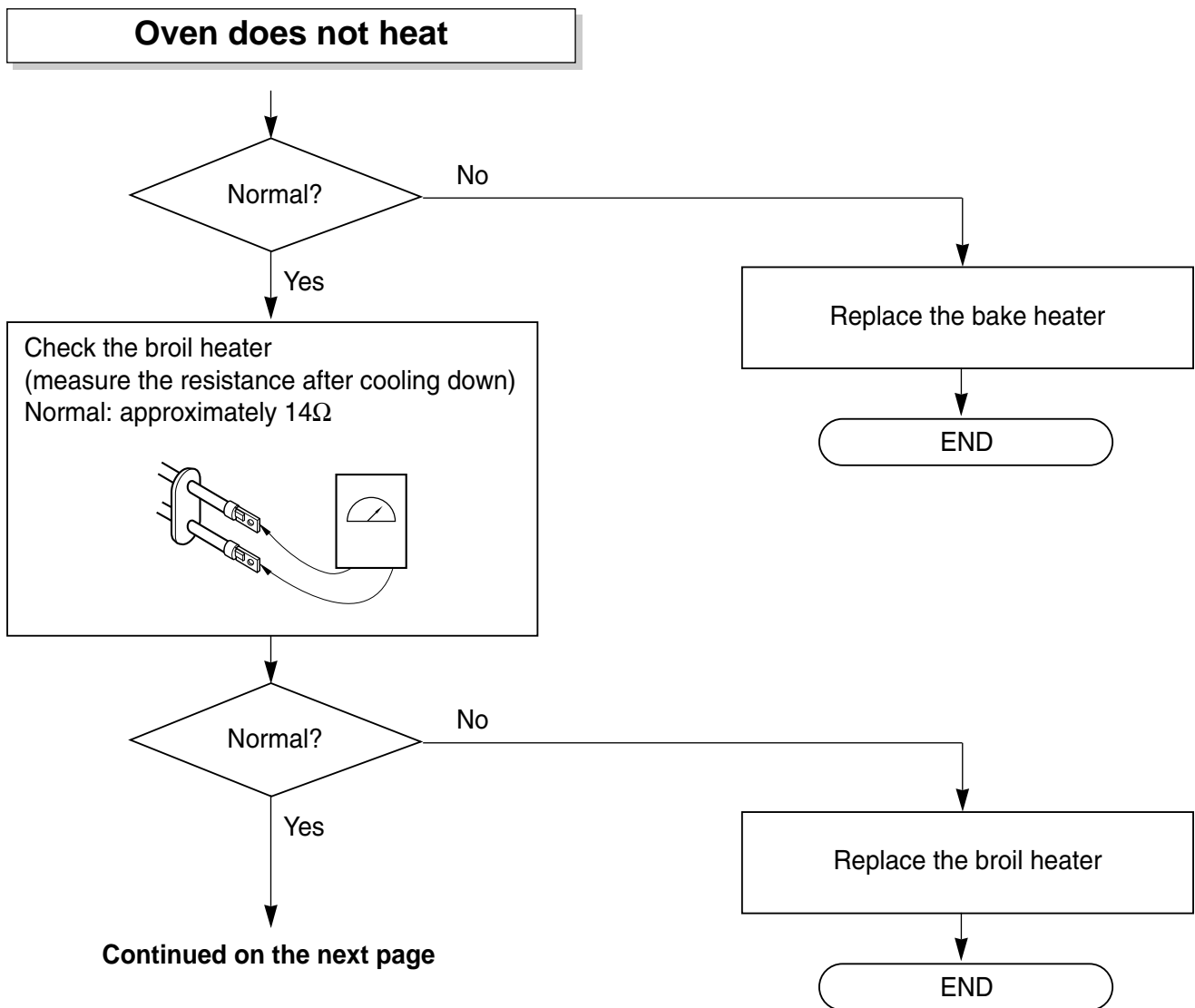

# FAILURE MODE FLOW CHART

Oven does not heat

Check for loose oven sensor connector

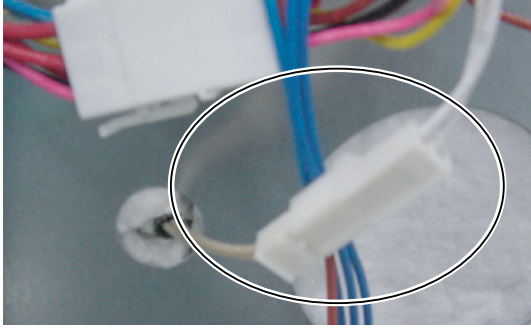

Normal?

No

Yes

Reconnect

END

Check the oven sensor  
(measure the resistance after cooling down)  
Normal: approximately 1.09kΩ

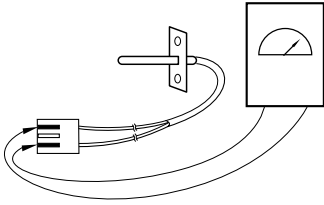

Normal?

No

Yes

Replace the oven sensor

END

Replace the oven relay PCB (012B)

Normal?

Yes

Replace the main PCB(002A)

END

For further check of main PCB  
Refer to the appendix A

# FAILURE MODE FLOW CHART

## Cook-top does not heat

No heating  
(All or a part of cook-top heaters)

Disconnect power

Check for loose connection at board (002A PCB)  
to cook top heaters.

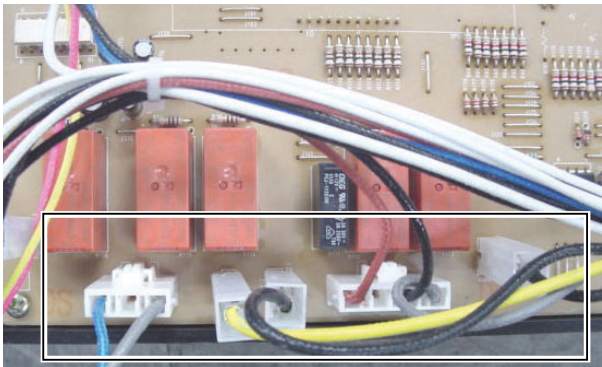

Normal?

No

Yes

Reconnect.  
If defective harness, replace or fix

END

Continued on the next page

# FAILURE MODE FLOW CHART

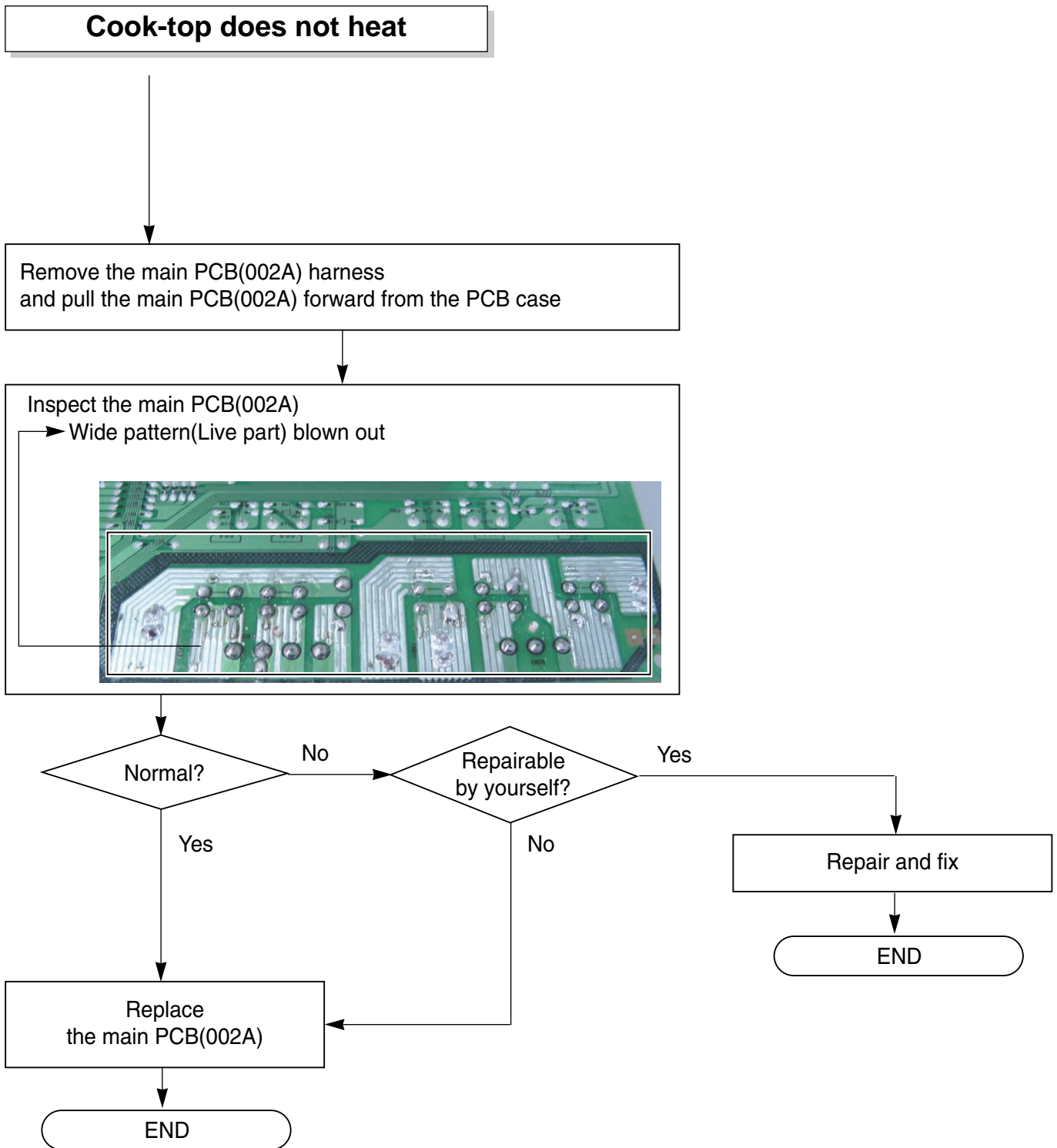

# FAILURE MODE FLOW CHART

## Oven lamp does not operate

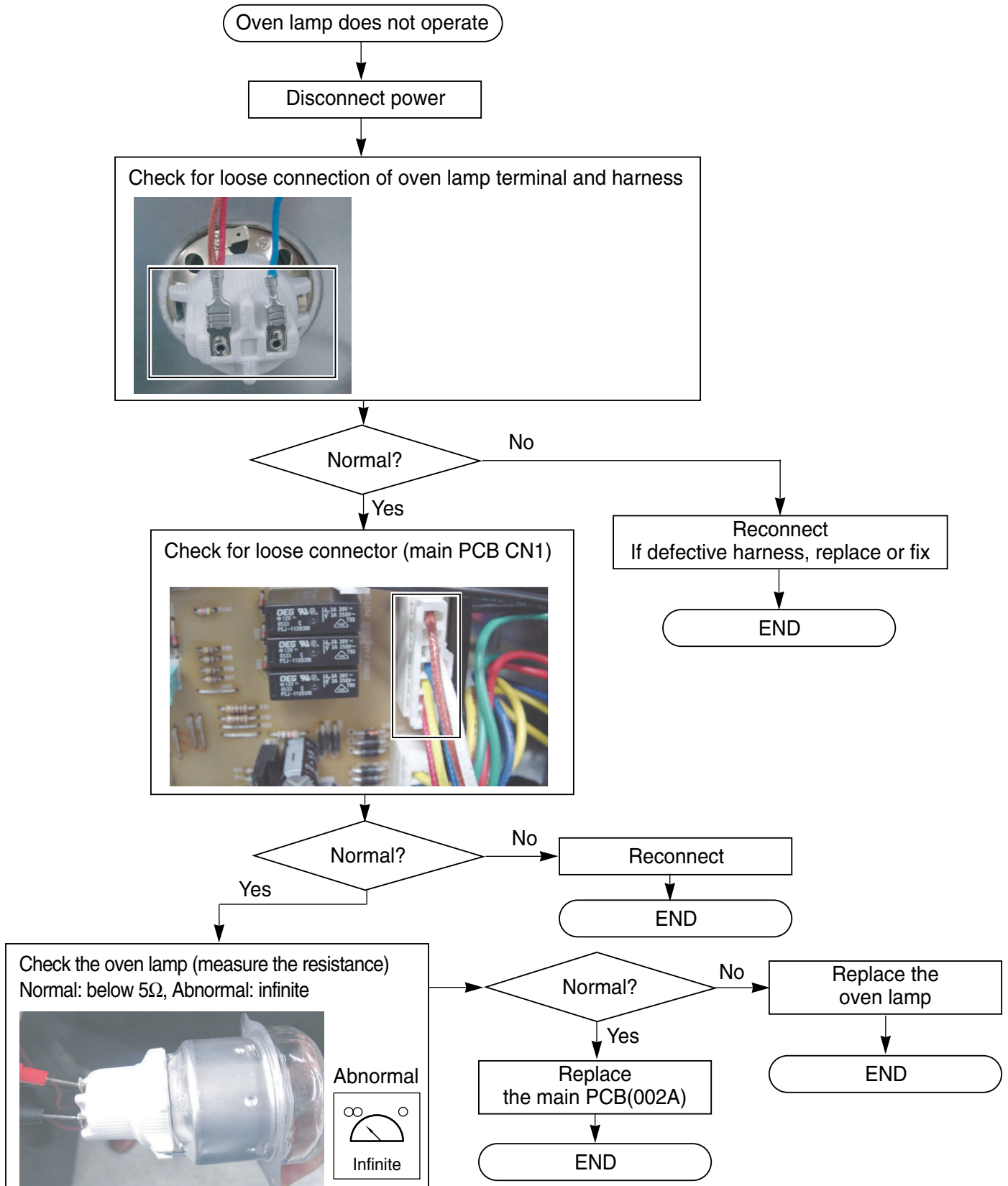

# FAILURE MODE FLOW CHART

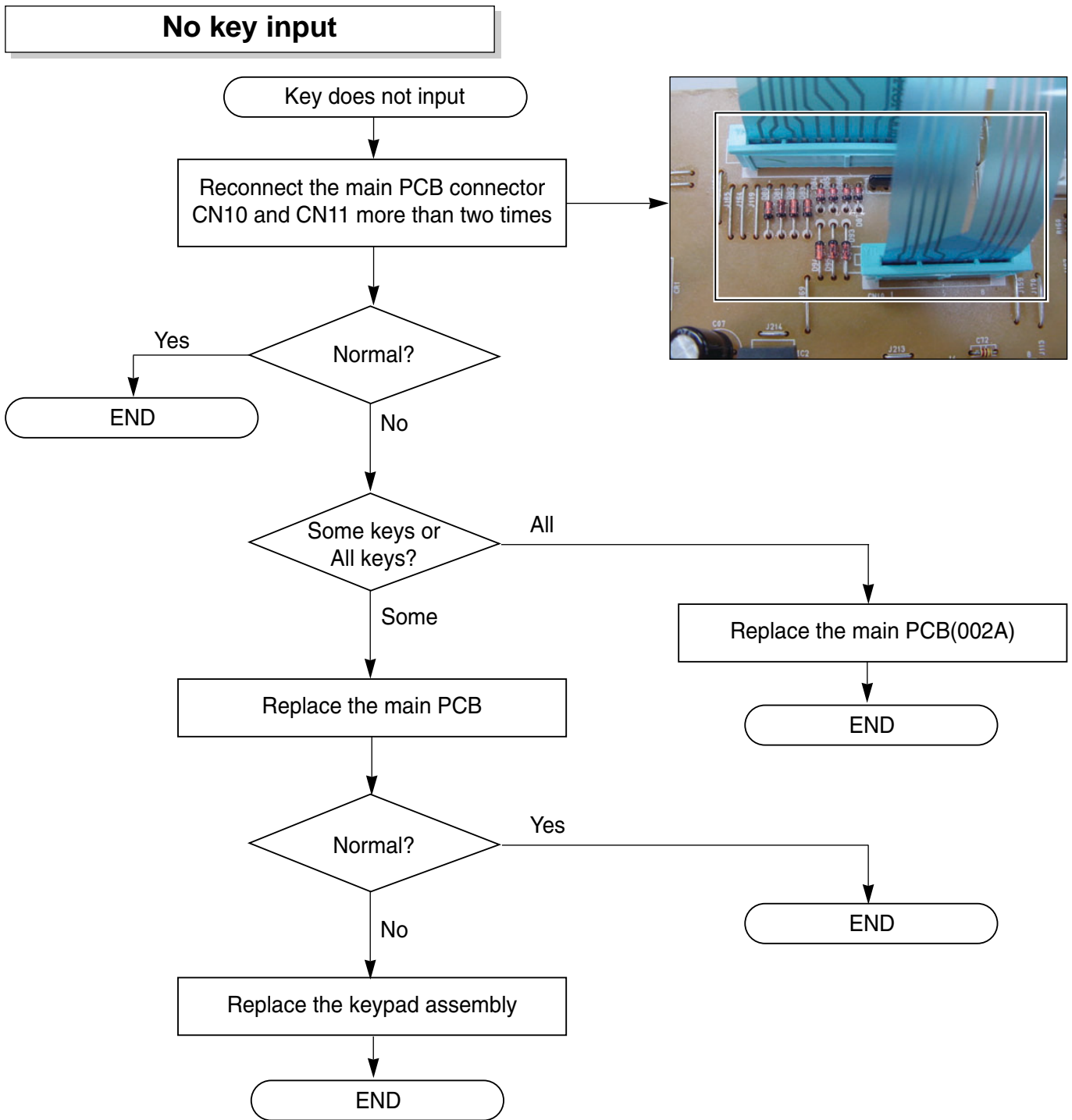

# FAILURE CODES

## WARNING

- Disconnect power supply cord from the outlet before servicing
- Replace all panels and parts before operating.
- Reconnect all grounding devices  
Failure to do so can result in death or electrical shock

## "F" (Failure) DISPLAY CODES

Before doing any action, perform the following step1~3.

**Step1.** Unplug range or disconnect power.

**Step2.** Check if connector is fully seated or not.

**Note:** All units in the first few days of use should be checked for mis-wiring or loose connections.

DISPLAY SHOWS	CAUSE	CORRECTIVE ACTION
F1	Key held down too long or shorted key	A. Perform step 1 through 2 above B. Replace keypad or keypad assembly (if F code recur, go to C after unplugging or disconnecting) C. Replace Control (PCB) assembly
F2	Door Locking system don't operate	A. Perform step 1 through 2 above B. Check wire and connections from control to latch C. If motor operate, check integrity of latch mechanism - check the micro-switch (refer to component test section) - check integrity of door locking mechanism D. If motor didn't operate, check continuity of the latch motor and electrical connections - if the wiring is bad, replace the harness - if the wiring is good, replace the door motor assembly - if F code recur, replace control
F3	Main oven Sensor opened	A. Perform step 1 through 2 above B. Open the back panel and check continuity of the sensor and Control (PCB) C. Disconnect sensor from harness
F4	Main oven Sensor shorted	D. - Measure $\Omega$ value between connector pins : Approximately 1090 $\Omega$ (at room temperature: 77F/25°C) - Measure value between sensor chassis and any connector pins : $\Omega$ value should read OPEN => if there is any problem, Replace oven sensor E. If you couldn't find any problem, Replace Control (PCB)

DISPLAY SHOWS	CAUSE	CORRECTIVE ACTION
F7	Main oven heating error	A. Perform step 1 through 2 above B. Open the back panel and check continuity of the sensor, heater (bake, broil) and Control(PCB) C. Check the bake and broil heater(refer to component test) D. Disconnect sensor from harness - Measure $\Omega$ value between connector pins of oven sensor - Measure $\Omega$ value between sensor chassis and any connector pins : $\Omega$ value should read OPEN => if there is any problem, Replace oven sensor E. If you couldn't find any problem, Replace Control(PCB)
F9	Oven is too hot; Bad oven sensor; Bad control (PCB)	A. Perform step 1 through 2 above B. Open the back panel and Disconnect sensor from harness - Measure $\Omega$ value between connector pins : approximately 1090 $\Omega$ (at room temperature :77F/25°C) => if there is any problem, Replace oven sensor C. Check the bake and broil relay (refer to the strip circuit section) STRIP CIRCUITS D. If there is any problem, Replace Control (PCB)

# F-CODE FLOW CHART

## Key short error → F-1 error

Code	Error mode	Operation	Times/sampling
F-1	Key shorted	If a key pad is continuously short for $\geq 60$ seconds.	

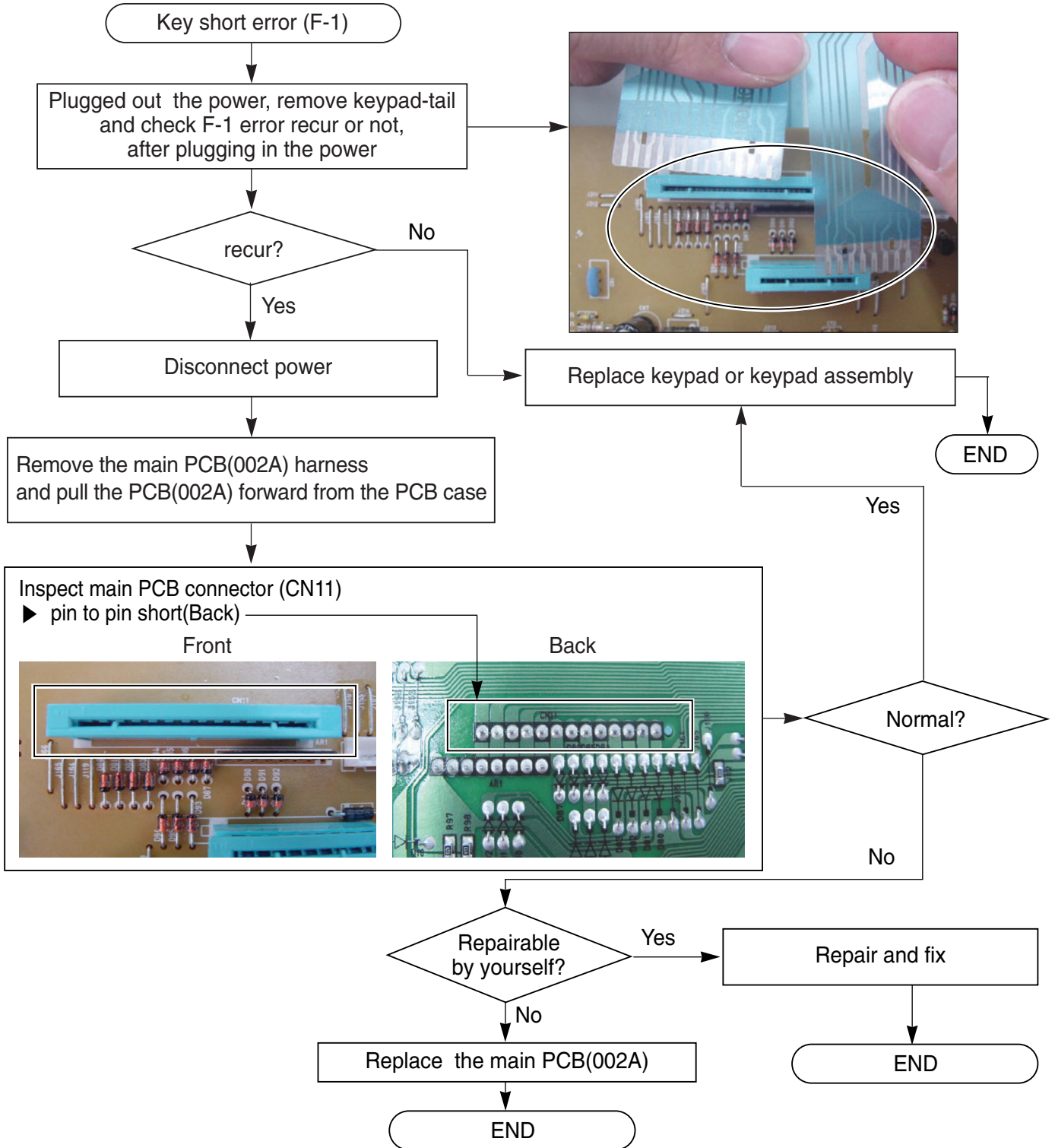

# F-CODE FLOW CHART

## Door lock system error → F-2 error

Code	Error mode	Operation	Times/sampling
<b>F-2</b>	Door Lock Fail	In case of Door Lock Failure	

→ Just after self-clean start, the door lock motor starts to rotate. During that time if the door lock switch does not operate properly after rotating twice, then supervising circuit detects a Door Lock failure and the F-2 error code appears.

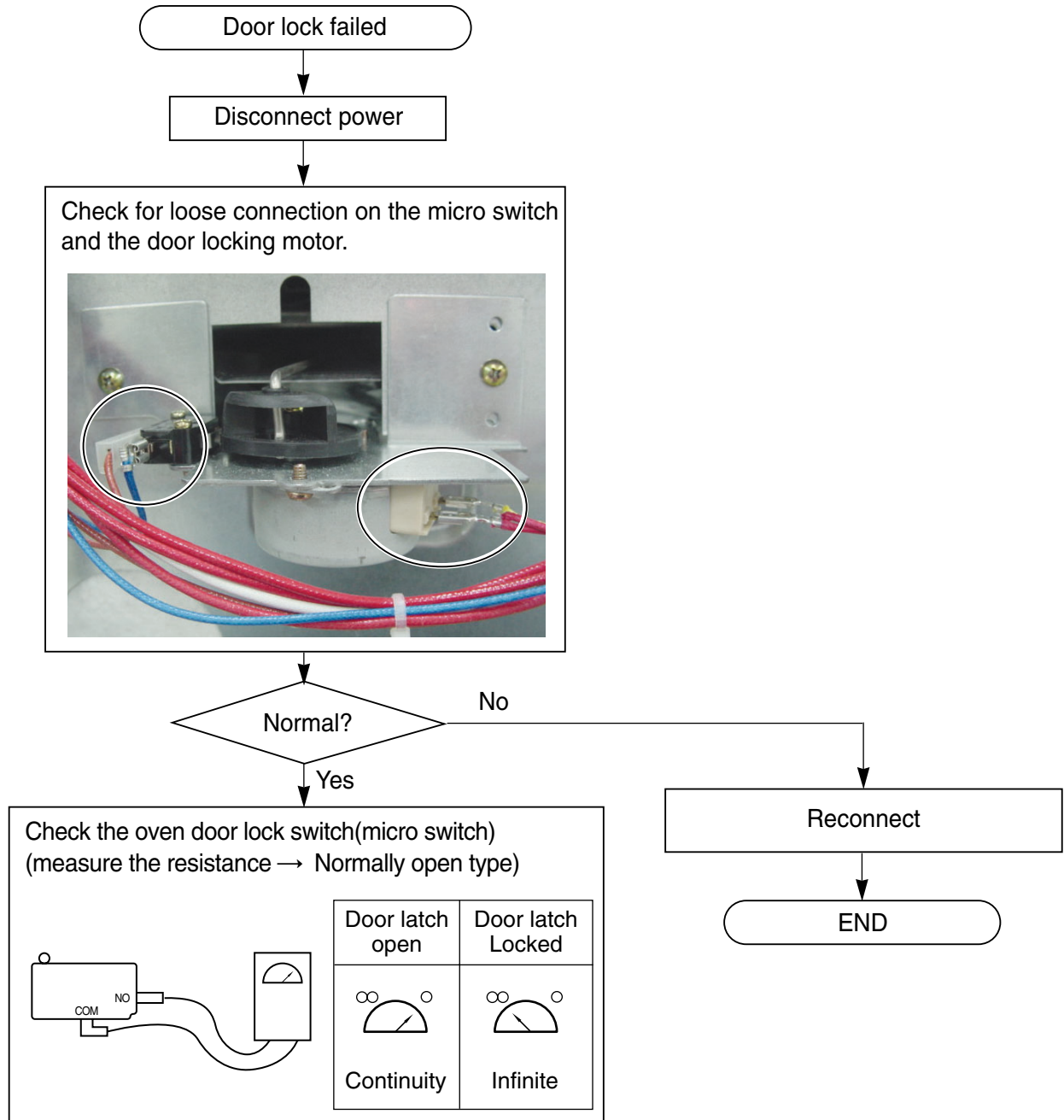

**Continued on the next page**

# F-CODE FLOW CHART

## Door lock system error → F-2 error

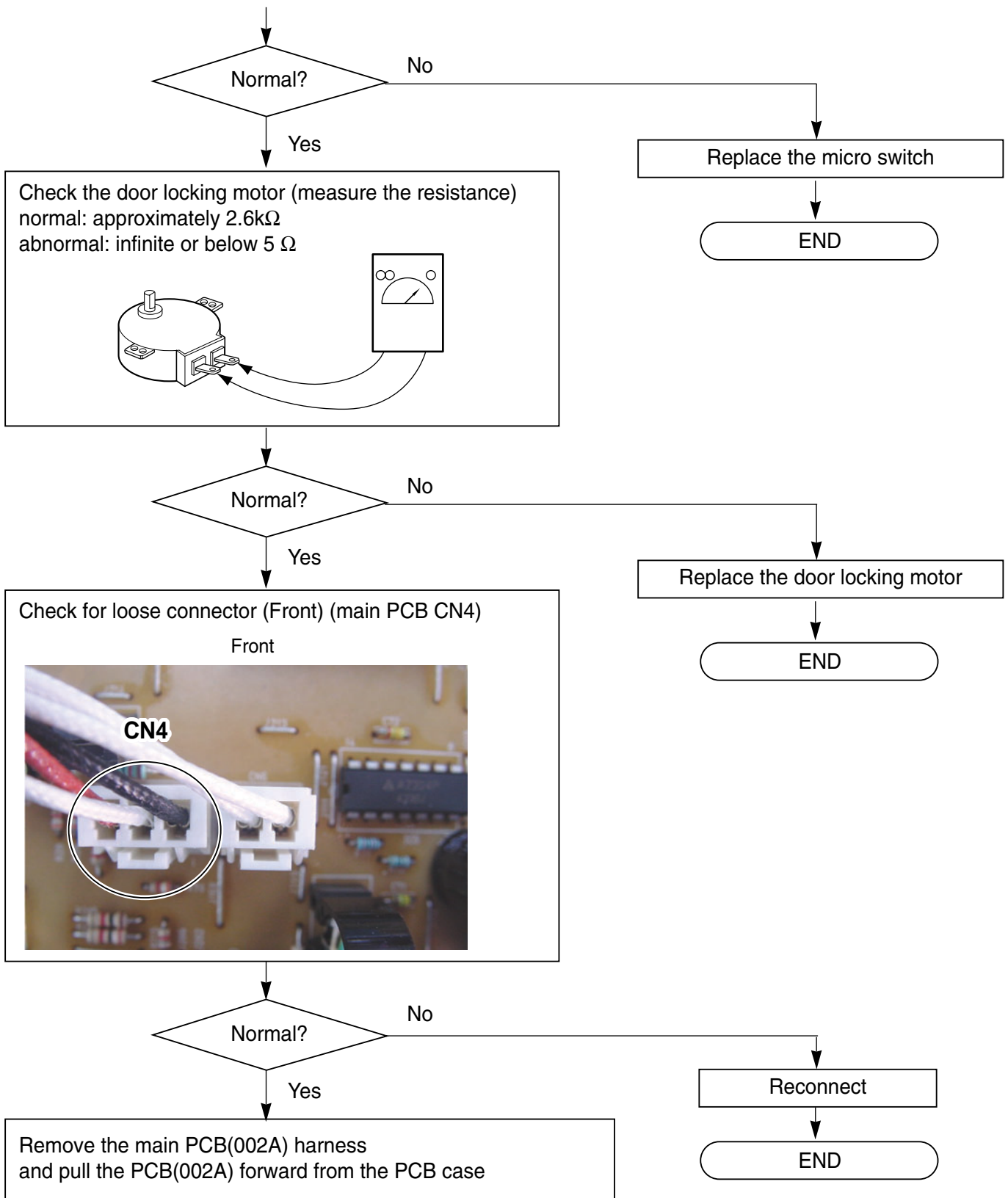

# F-CODE FLOW CHART

Door lock system error → F-2 error

Inspect connector pin solder of CN4 (Back) (main PCB CN4)

Back

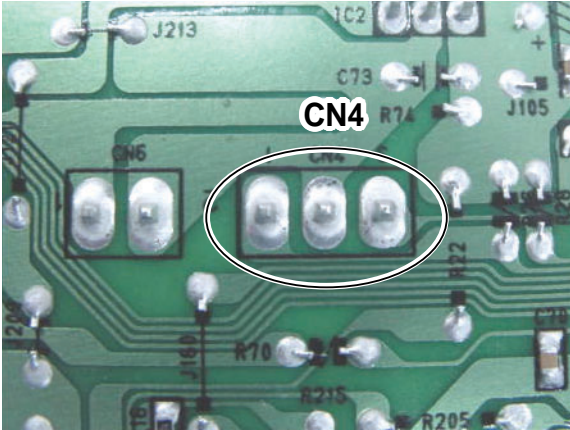

※ If pin solder is cracked, repair and re-use

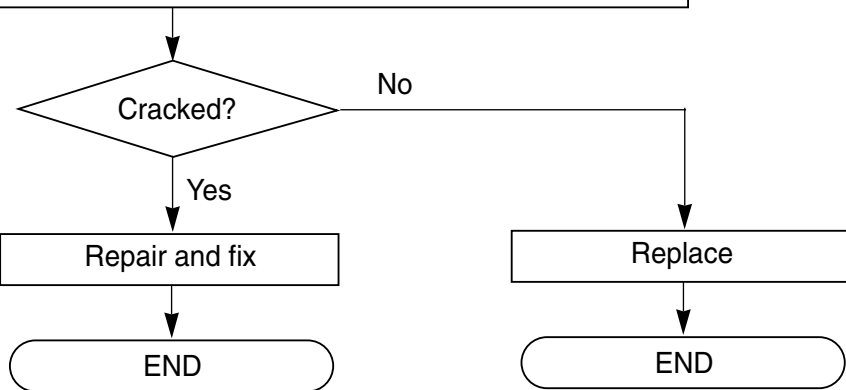

# F-CODE FLOW CHART

## Main oven sensing error → F-3, F-4 error

Code	Error mode	Operation	Times/sampling
F-3	Opened Sensor	Oven Thermistor remains open for over 1 min, after cook starts	During cook
F-4	Shorted Sensor	Oven Thermistor is short for over 1 min after cook starts	During cook

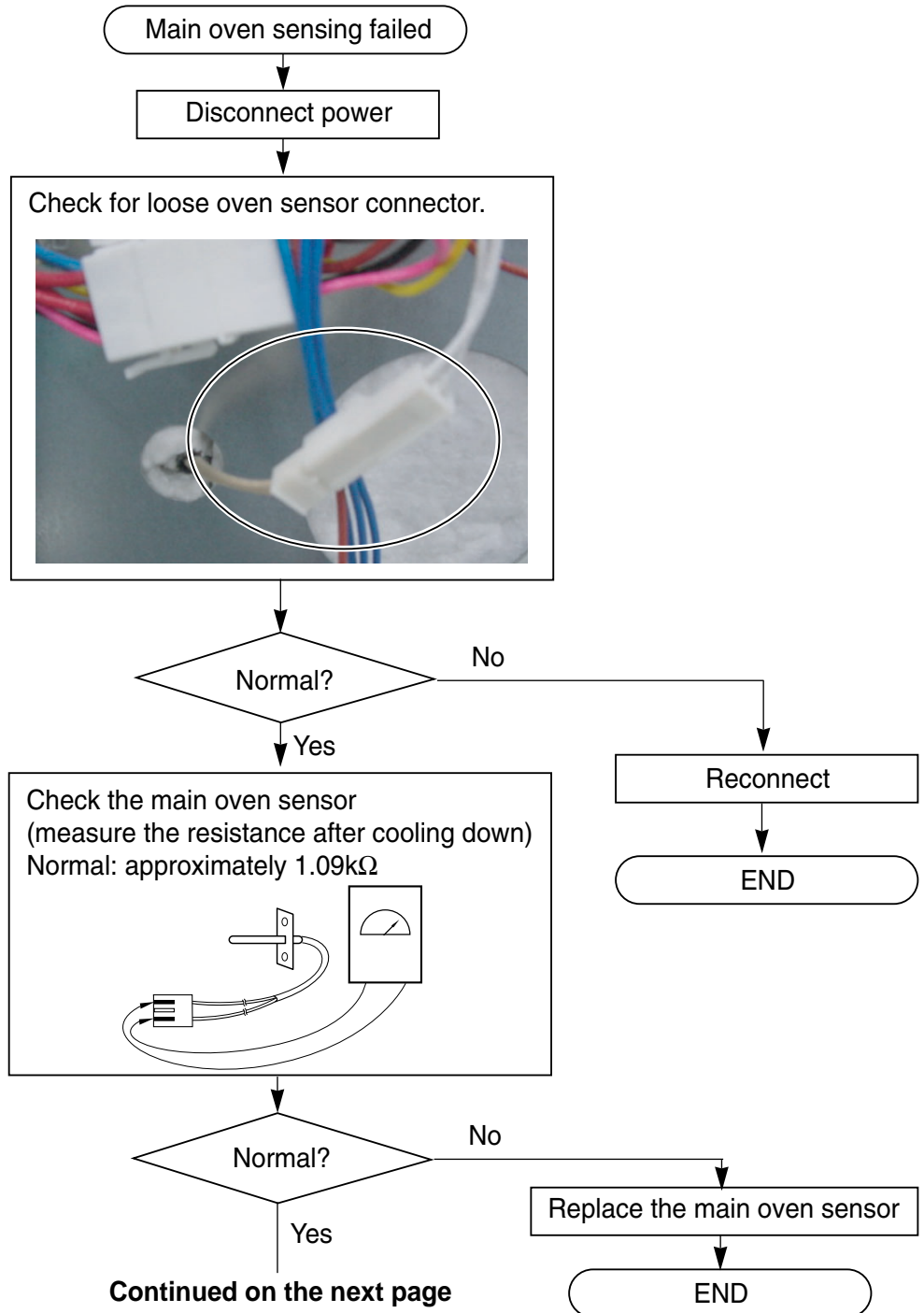

# F-CODE FLOW CHART

## Main oven sensing error → F-3, F-4 error

Check for loose connector.  
(Front) (main PCB CN6)

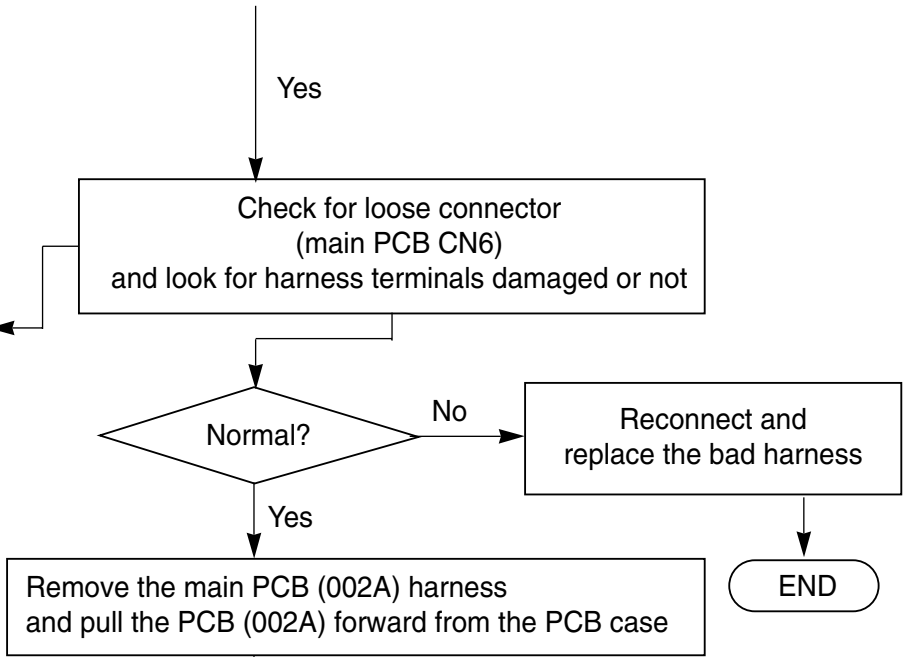
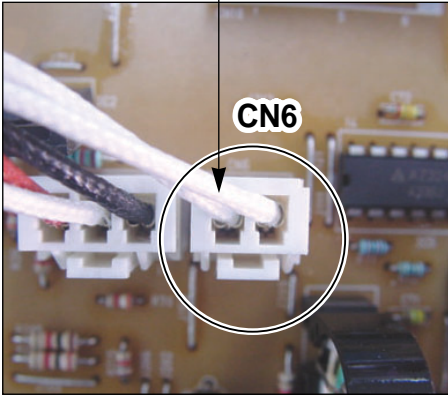

Inspect connector pin solder of CN6 (Back) (main PCB CN6)

Back

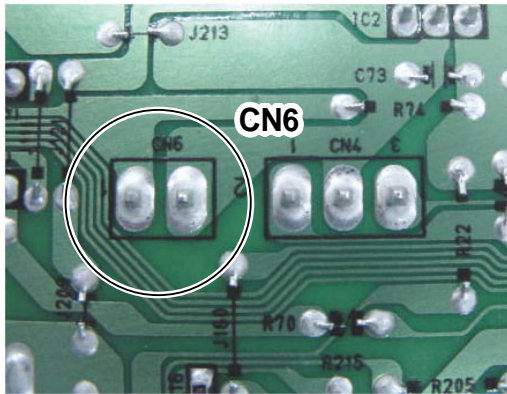

※ If pin solder is cracked,  
repair and re-use

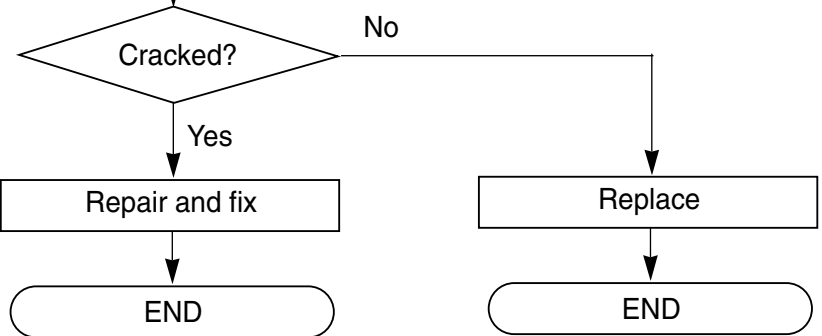

# F-CODE FLOW CHART

## Oven too hot error → F-9 error

Code	Error mode	Operation	Times/sampling
F-9	Oven hot	Oven temperature is over 650°F continuously during 2 minutes on cooking.	During cook (Not self clean mode)

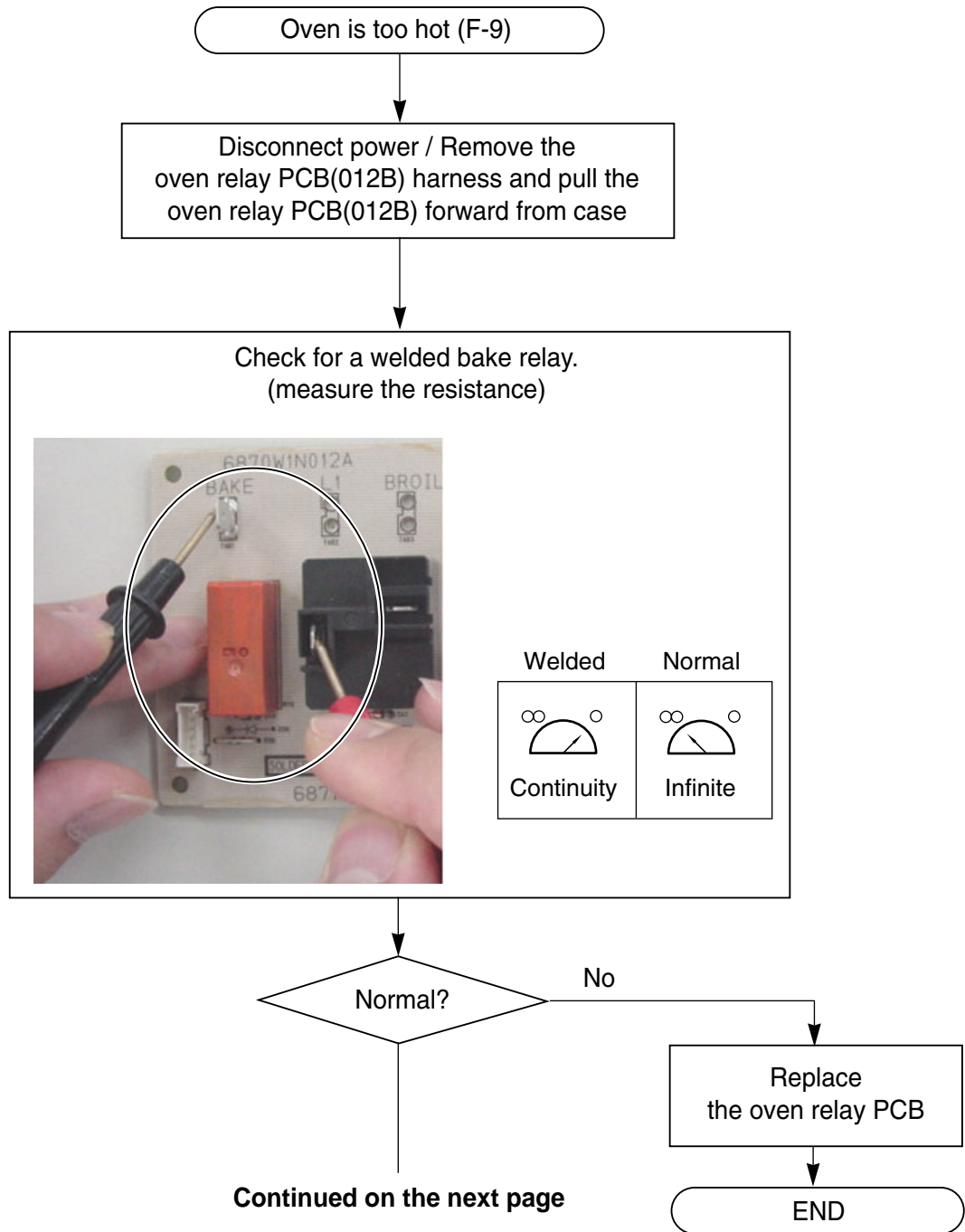

# F-CODE FLOW CHART

Oven too hot error → F-9 error

Yes

Check for a welded broil relay.  
(measure the resistance)

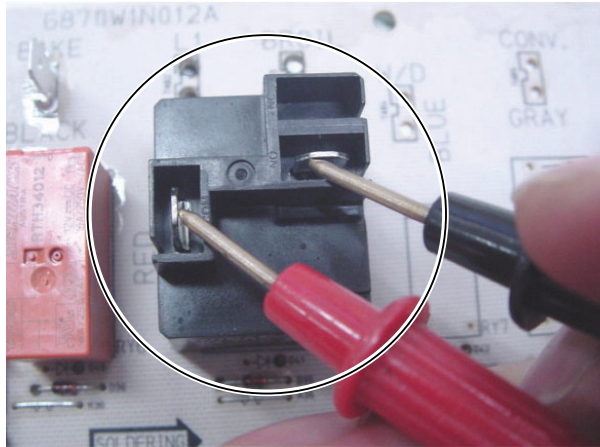

Welded

Normal



Continuity



Infinite

Normal?

No

Yes

Replace  
the main relay PCB(002A)

END

Replace  
the oven relay PCB(012B)

END

# TROUBLE SHOOTING

PROBLEMS	POSSIBLE CAUSES & FAULTS	SOLUTIONS
Oven not operating.	<ul style="list-style-type: none"> <li>• Bad power control board (PCB)</li> <li>• Power outage</li> </ul>	<ul style="list-style-type: none"> <li>• Test and/or replace PCB → Refer to the page 6-1~6-3</li> <li>• Verify power is present at unit.</li> <li>• Verify that the circuit breaker is not tripped</li> <li>• Replace household fuse capacity</li> </ul>
Oven element does not heat.	<ul style="list-style-type: none"> <li>• No line voltage</li> <li>• Loose or bad wiring.</li> <li>• Defective element.</li> <li>• Bad Power control board(PCB)</li> </ul>	<ul style="list-style-type: none"> <li>• Check circuit breaker.</li> <li>• Repair or replace wiring (see wiring diagrams).</li> <li>• Test and/or replace element.</li> <li>• Test and/or replace PCB → Refer to the page 6-4~6-6</li> </ul>
Surface element barely heats Surface element will not heat Higher than low-medium	<ul style="list-style-type: none"> <li>• Loose or bad wiring connection at element or terminal block.</li> <li>• Defective Surface units control PCB</li> <li>• Defective Surface element.</li> <li>• Low line voltage</li> </ul>	<ul style="list-style-type: none"> <li>• Verify all connections are clean and tight, replace broken wires</li> <li>• Test and/or replace cook-top PCB → Refer to the page 6-7~6-8</li> <li>• Test and/or replace element.</li> <li>• Line voltage should be minimum 240-volts. Of necessary, electrician should repair cause for low line voltage</li> </ul>
Frequent cycling of surface Element or warming zone	<ul style="list-style-type: none"> <li>• This is normal</li> </ul>	<ul style="list-style-type: none"> <li>• The element will cycle on and off to maintain the heat setting</li> </ul>
“HS” (Hot surface)Warning message does not light up	<ul style="list-style-type: none"> <li>• Defective cook-top control PCB</li> </ul>	<ul style="list-style-type: none"> <li>• Test and/or replace cook-top PCB</li> </ul>
Oven light fails to operate. (Refer to the page 6-9)	<ul style="list-style-type: none"> <li>• Failed oven lamp.</li> <li>• Circuit breaker or fuse is open</li> <li>• Loose or bad wiring</li> <li>• Defective light socket.</li> <li>• Defective door switch</li> </ul>	<ul style="list-style-type: none"> <li>• Check lamp and Replace is necessary</li> <li>• Check circuit breaker or replace fuse.</li> <li>• Repair or replace wiring</li> <li>• Check light socket for continuity.</li> <li>• Test and/or replace door switch</li> </ul>
Oven does not begin clean cycle  Oven stop for Self clean cycle	<ul style="list-style-type: none"> <li>• Bad wiring</li> <li>• Bad latch system</li> <li>• Programming error</li> <li>• Defective a point of contact with door switch</li> </ul>	<ul style="list-style-type: none"> <li>• Repair or replace wiring</li> <li>• Check door locking motor and micro switch</li> <li>• Shut off power to oven for five minutes by switching off circuit breaker. Reset circuit breaker and try oven again.</li> <li>• Test door switch and check the point of contact between door and door switch</li> </ul>

# TROUBLE SHOOTING

PROBLEMS	POSSIBLE CAUSES & FAULTS	SOLUTIONS
Electronic timer will not accept Programming.	<ul style="list-style-type: none"> <li>• Failed main power control board</li> </ul>	<ul style="list-style-type: none"> <li>• Replace power control board(PCB)</li> </ul>
Electronic timer will not accept Programming.	<ul style="list-style-type: none"> <li>• Failed main power control board</li> </ul>	<ul style="list-style-type: none"> <li>• Replace power control board(PCB)</li> </ul>
Clock and timer not working	<ul style="list-style-type: none"> <li>• Power outage</li> </ul>	<ul style="list-style-type: none"> <li>• Verify power is present at unit.</li> <li>• Verify that the circuit breaker is not tripped</li> <li>• Replace household fuse, but do not fuse capacity</li> <li>• Refer to Owner's manual instructions</li> </ul>
Oven does not bake (Selection is set for to BAKE or TIMED BAKE)	<ul style="list-style-type: none"> <li>• Loose or bad wiring</li> <li>• Defective BAKE element</li> <li>• Defective electronic clock</li> <li>• Door switch sensing error</li> </ul>	<ul style="list-style-type: none"> <li>• Verity all connections are clean and tight, replace broken wire</li> <li>• Test and/or replace BAKE element.</li> <li>• Replace power control board(PCB)</li> <li>• Test door switch and check the point of contact between door and door switch</li> </ul>
Oven does not Broil	<ul style="list-style-type: none"> <li>• Loose or bad wiring</li> <li>• Defective BROIL element</li> <li>• Defective Power Control Board</li> </ul>	<ul style="list-style-type: none"> <li>• Verity all connections are clean and tight, replace broken wire</li> <li>• Test and/or replace BAKE element.</li> <li>• Replace power control board(PCB)</li> </ul>
Overheating or "runaway" oven	<ul style="list-style-type: none"> <li>• Loose or bad wiring to latch system</li> <li>• Defective Oven Sensor</li> <li>• Bad Power Control Board(PCB)</li> </ul>	<ul style="list-style-type: none"> <li>• Repair or replace wiring</li> <li>• Test and/or replace Oven Sensor</li> <li>• Test and/or replace PCB</li> </ul>
Oven door will not open or latch.	<ul style="list-style-type: none"> <li>• Defective latch mechanism.</li> <li>• Defective(bent)door latch lever.</li> <li>• Oven is still hot. Cool-down period after self-clean cycle not complete</li> </ul>	<ul style="list-style-type: none"> <li>• Replace door latch system.</li> <li>• Replace latch lever</li> <li>• This is normal. Wait until LOCK icon goes out.</li> </ul>
Premature burnout of bake element	<ul style="list-style-type: none"> <li>• Improper use of oven(e.g. being used to heat the home)</li> </ul>	<ul style="list-style-type: none"> <li>• Use oven for baking only</li> </ul>
Oven door difficult to open	<ul style="list-style-type: none"> <li>• Worn or broken broil stop roller.</li> </ul>	<ul style="list-style-type: none"> <li>• Replace oven door hinge</li> </ul>

# TROUBLE SHOOTING

PROBLEMS	POSSIBLE CAUSES & FAULTS	SOLUTIONS
Oven door sagging on one side	<ul style="list-style-type: none"> <li>• Hinge loose or out of position to oven liner</li> </ul>	<ul style="list-style-type: none"> <li>• Adjust hinges or replace hinges</li> </ul>
Door does not close completely at top	<ul style="list-style-type: none"> <li>• Broken or misadjusted door spring</li> <li>• Door fits too tight at bottom.</li> </ul>	<ul style="list-style-type: none"> <li>• Adjust or replace hinges</li> <li>• Adjust hinges outward.</li> </ul>
Door glass breaks.	<ul style="list-style-type: none"> <li>• Oven racks covered with foil.</li> <li>• Glass installed backward.</li> </ul>	<ul style="list-style-type: none"> <li>• Do not cover racks with foil.</li> <li>• Install tempered glass toward the heat.</li> </ul>
Damaged oven door gasket.	<ul style="list-style-type: none"> <li>• Improper Self clean</li> </ul>	<ul style="list-style-type: none"> <li>• Do not use harsh abrasives or scouring pads. See Owner's manual instructions</li> </ul>
Oven racks fit too tight.	<ul style="list-style-type: none"> <li>• Racks were cleaned in self clean cycle</li> <li>• Tolerance buildup in oven liner.</li> </ul>	<ul style="list-style-type: none"> <li>• Apply a small amount of vegetable oil to a paper towel and wipe the edges of the oven racks with the paper towel. Do not spray with pam or other lubricant sprays.</li> <li>• Notify customer Assurance department.</li> </ul>
Oven smokes/odor first few times of usage	<ul style="list-style-type: none"> <li>• This is normal</li> </ul>	<ul style="list-style-type: none"> <li>• Minor smoking or odor is normal for the first few times of oven usage</li> <li>• Ventilate area well and perform self clean cycle</li> </ul>
Excessive smoking during a Self clean cycle	<ul style="list-style-type: none"> <li>• Excessive soil</li> </ul>	<ul style="list-style-type: none"> <li>• Press the CLEAR/OFF pad. Open the windows to rid the room of smoke. Wait until the Self Clean cycle is cancelled. Wipe up the excess soil and reset the clean</li> </ul>
Convection fan make a noise	<ul style="list-style-type: none"> <li>• A convection fan may automatically turn on and off. Low level noise is normal</li> <li>• Loose nut of convection fan</li> <li>• Deformed convection fan</li> </ul>	<ul style="list-style-type: none"> <li>• Low level noise is normal</li> <li>• Re-fasten the nut</li> <li>• Replace the convection fan.</li> </ul>
Failures Codes	<ul style="list-style-type: none"> <li>• Electronically controlled</li> </ul>	<ul style="list-style-type: none"> <li>• Refer to "Failure codes" parts (page 7-0~7-8)</li> </ul>
Oven temperature too hot or too cold	<ul style="list-style-type: none"> <li>• Oven sensor needs to be adjusted</li> </ul>	<ul style="list-style-type: none"> <li>• See "the adjusting your oven temperature" in owners manual</li> </ul>

# SCHEMATIC DIAGRAM

**For Model: LRE30451SW / SB / ST**

**▲ WARNING**  
 POWER MUST BE  
 DISCONNECTED BEFORE  
 SERVICING THE APPLIANCE

※ RADIANT COOK-TOP

Wattage	Ω
RR:1200W	approx.47Ω
LR:1200W	approx.47Ω
RF:2700W	approx.23Ω
LF(Left Front) :1200W(inner)	approx.32Ω
:2500W(Dual)	approx.56Ω
CR:100W	approx.570Ω

WIRE COLORS

SYMBOL	COLOR
WH	WHITE
BK	BLACK
RD	RED
YL	YELLOW
PK	PINK
BL	BLUE
BN	BROWN
GN	GREEN
GY	GRAY

**NOTE:** Schematic diagram shows door switch in the cook position with the oven door open and elements off.

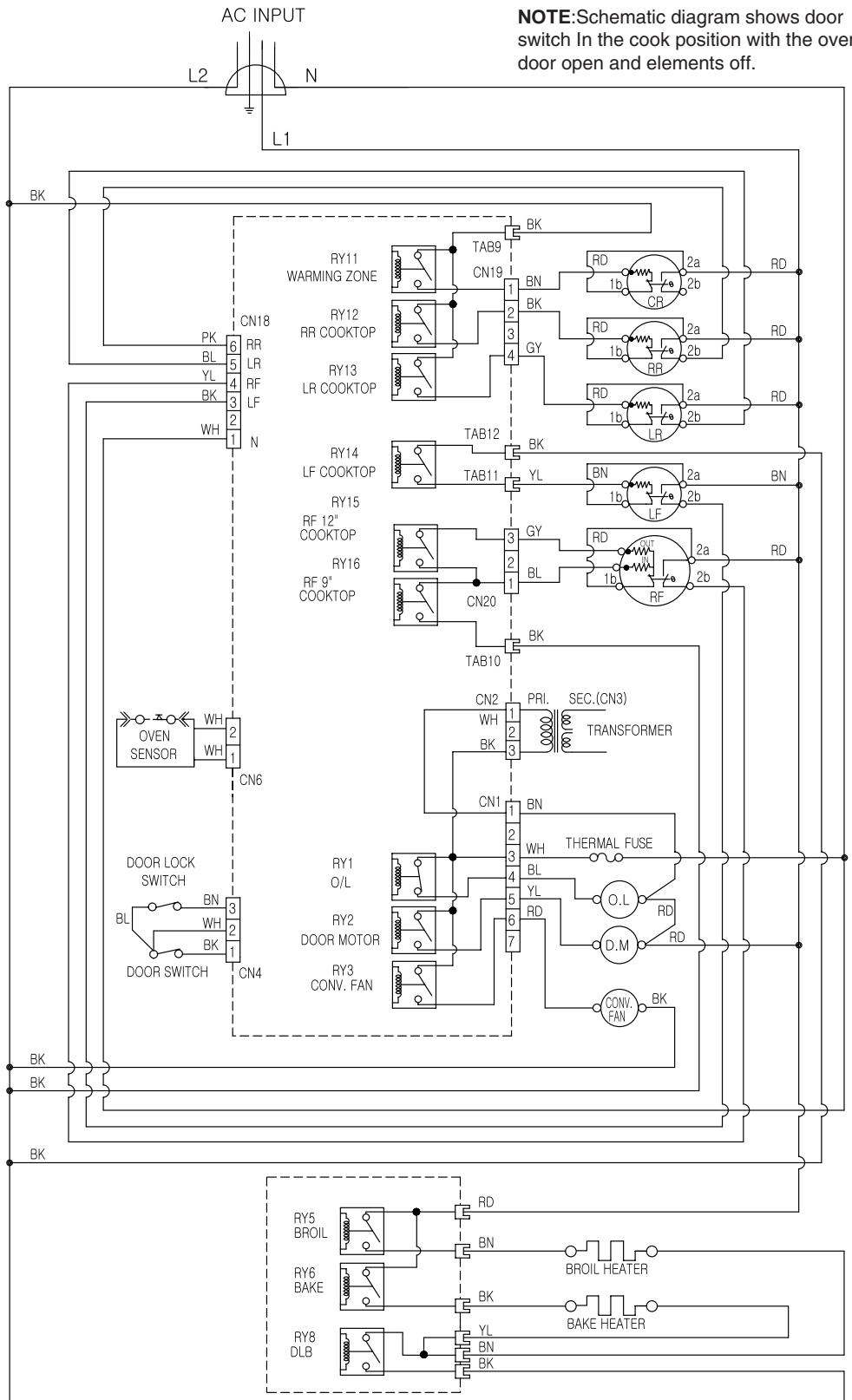

# STRIP CIRCUITS

Complete the following steps before checking electric oven circuit :

1. Check the line voltage, household fuse or circuit breaker.
2. Check for loose wiring or mis-wiring within electric range.

**NOTE:** The following individual circuits are for use in diagnosis, and are shown in the ON position.

**For Model: LRE30451SW / SB / ST**

**BAKE / COOK & WARM / PROOF**

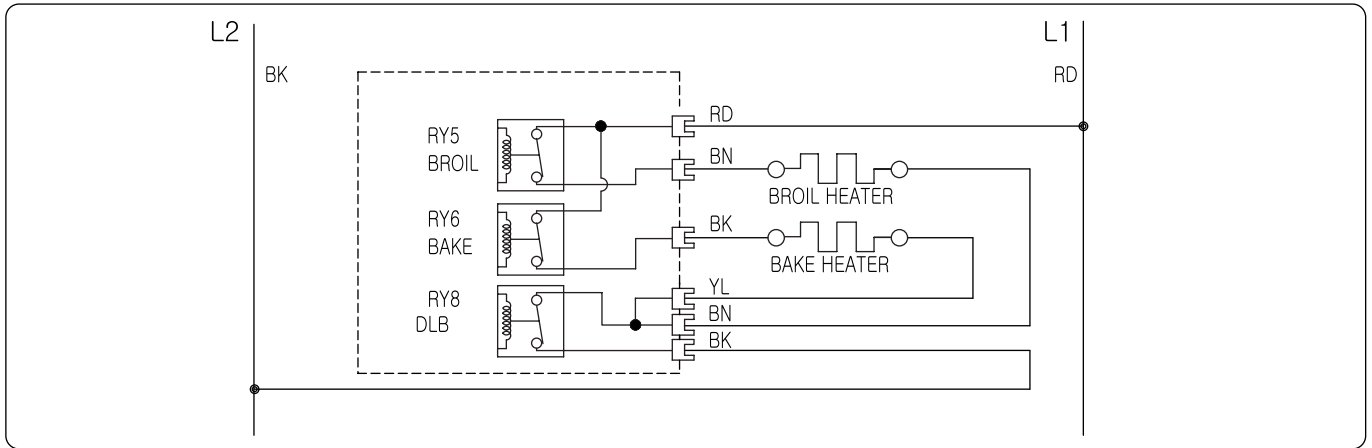

**BROIL**

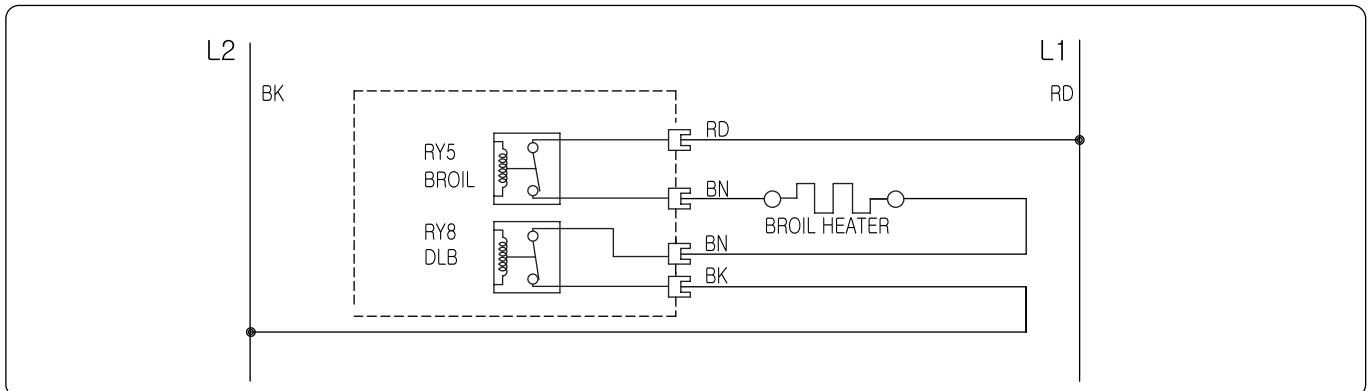

**OVEN LIGHT**

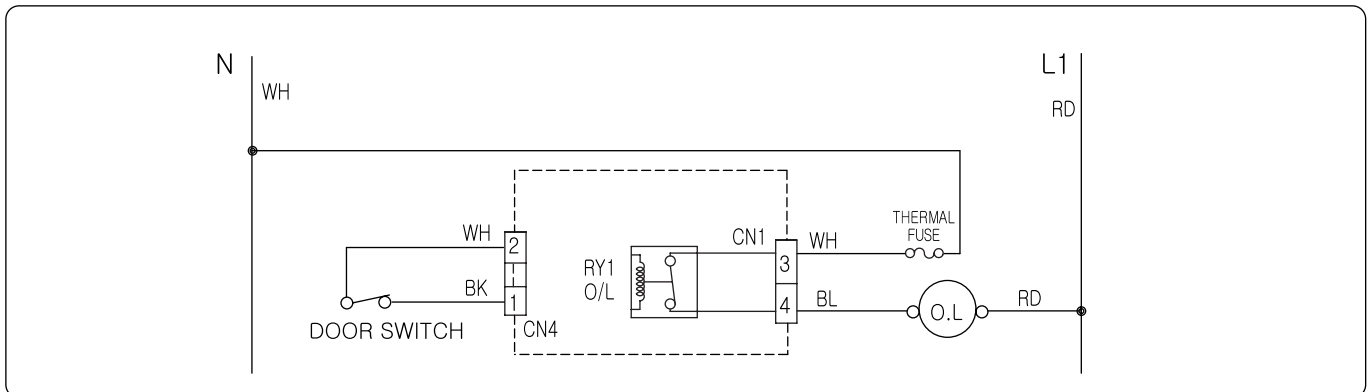

# For Model: LRE30451SW / SB / ST

## SELF CLEANING

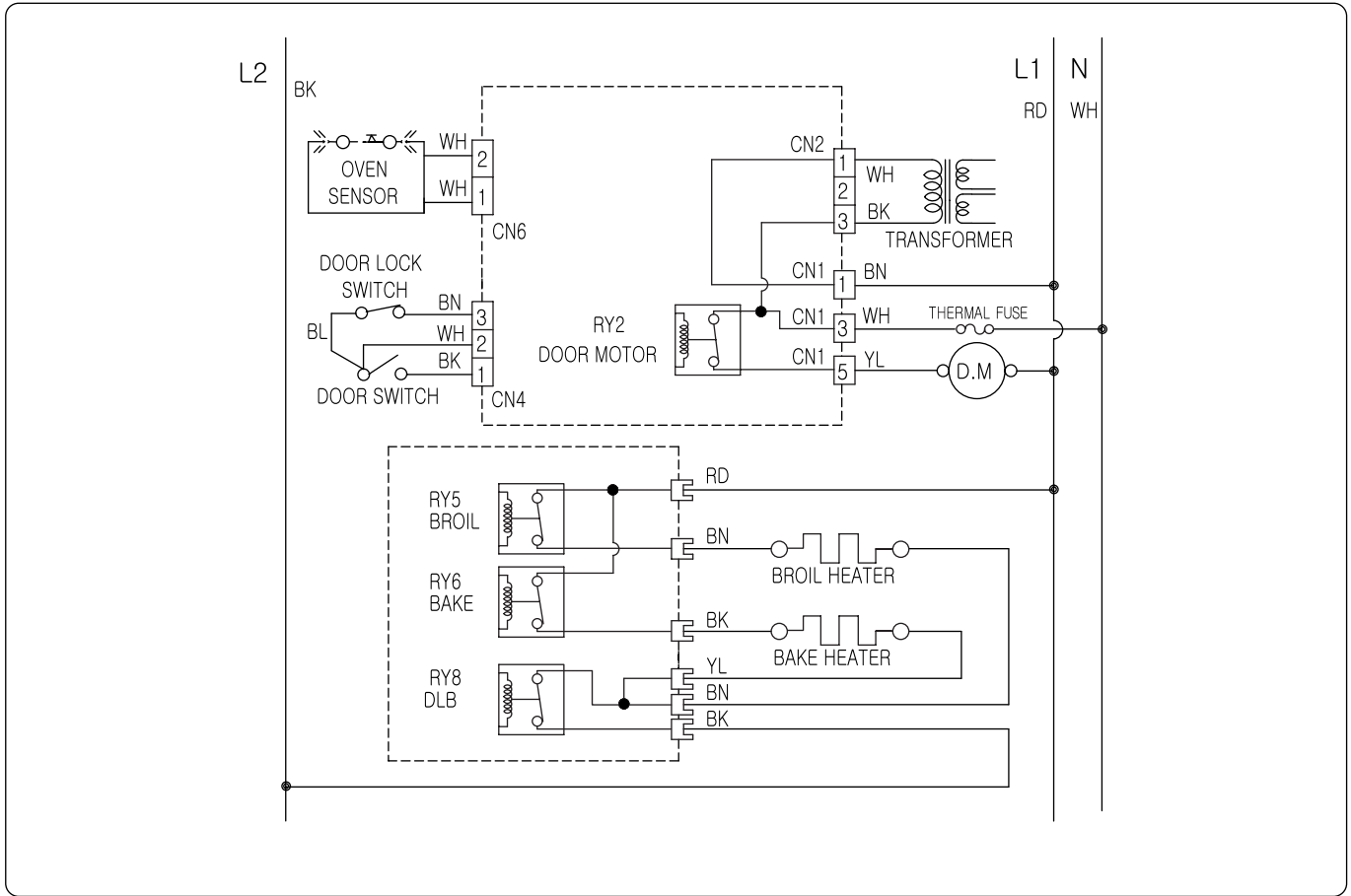

## CLOCK DISPLAY ON

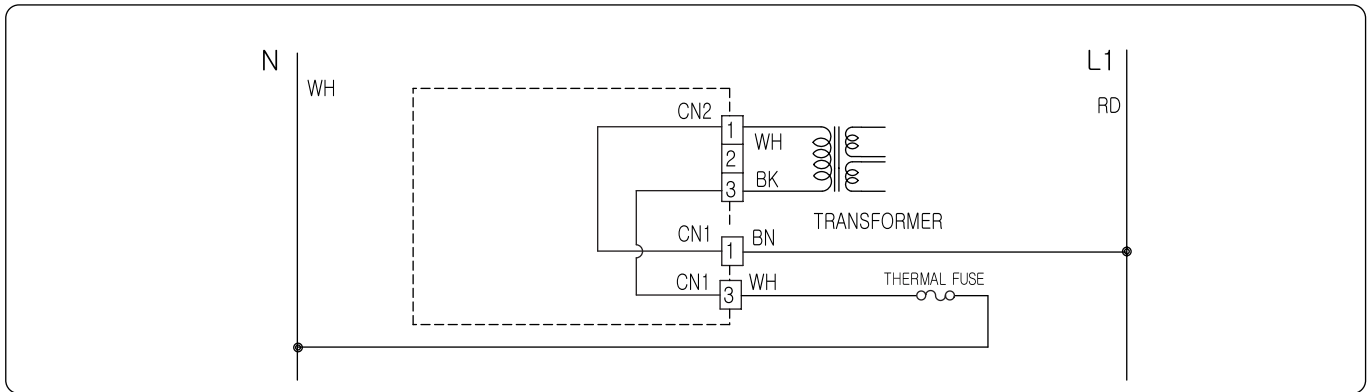

**For Model: LRE30451SW / SB / ST**  
**CONV. BAKE / CONV. ROAST**

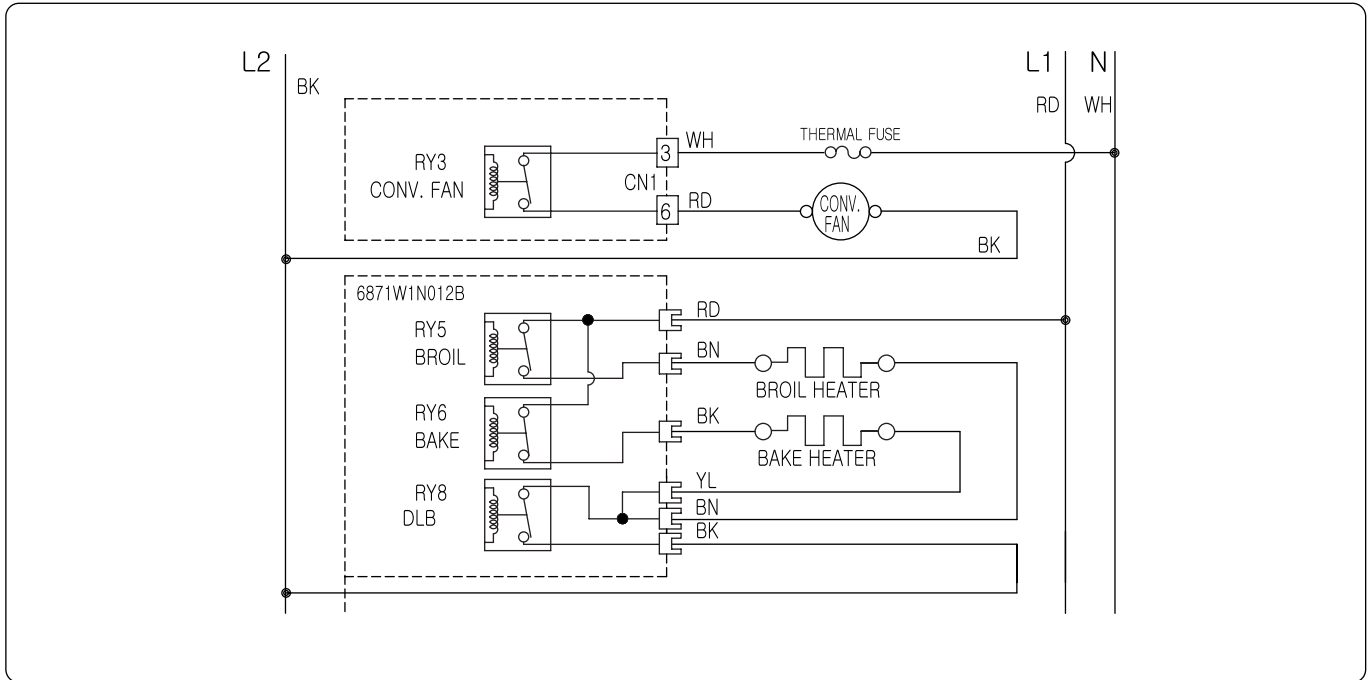

**CR(Warming Zone)**

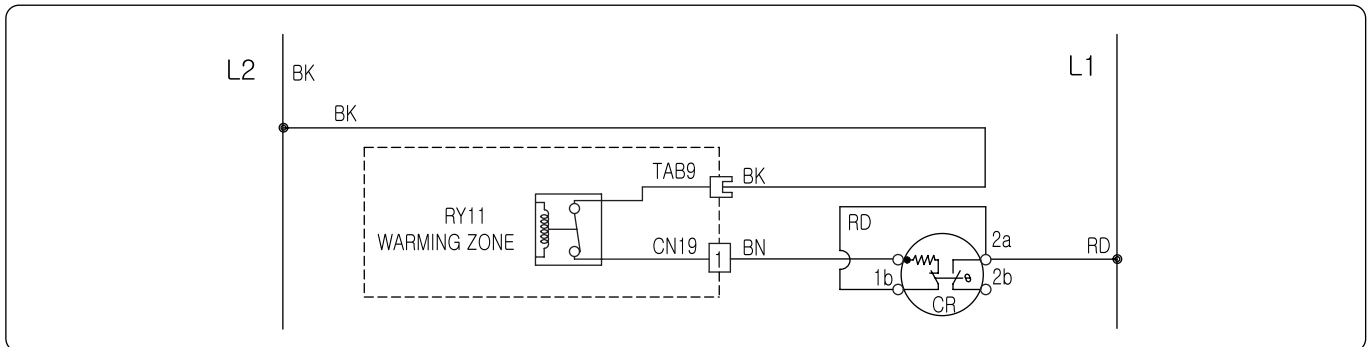

**RR Cook-top Element**

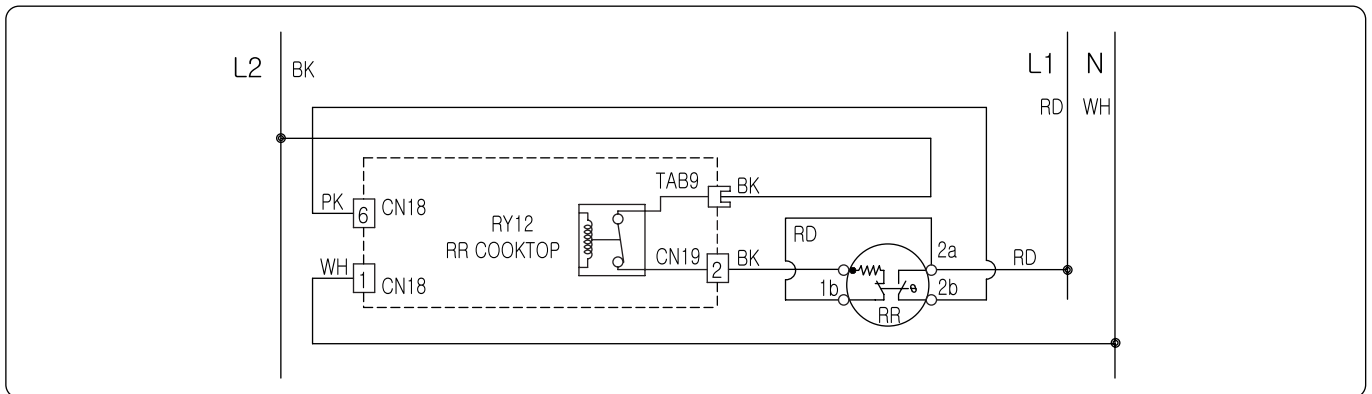

# For Model: LRE30451SW / SB / ST

## LR Cook-top Element

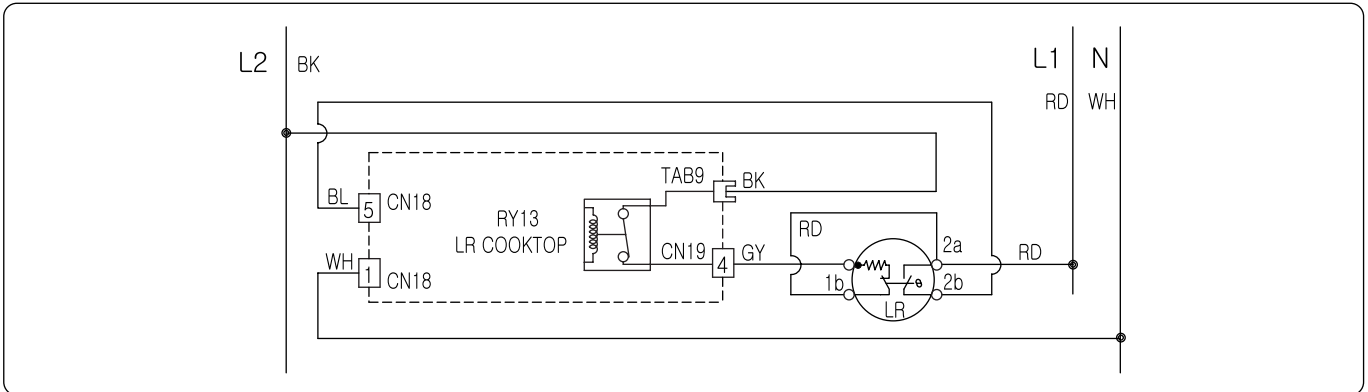

## RF Cook-top Element

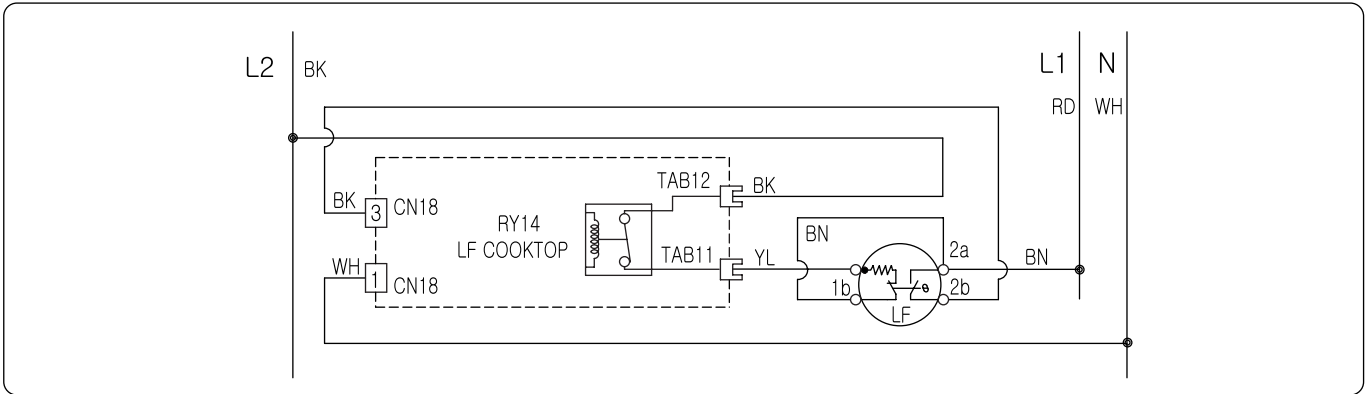

## LF Cook-top Element

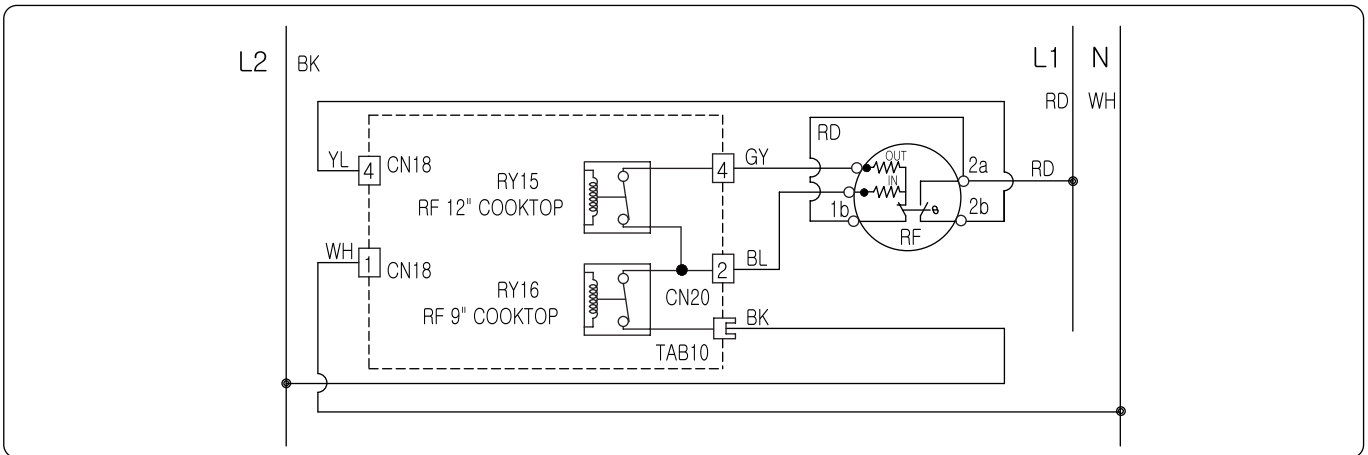

# EXPLODED VIEW

## INTRODUCTION (I)

SVC Model	Factory Model	Suffix
LRE30451SW	LFRF0222	AWHELGA
LRE30451SW / 01	LFRF0222	AWHLLGA
LRE30451SW / 02	LFRF0222	AW1LLGA
LRE30451SW / 03	LFRF0222	AW2LLGA
LRE30451SB	LFRF0222	ABKELGA
LRE30451SB / 01	LFRF0222	ABKLLGA
LRE30451SB / 02	LFRF0222	AB1LLGA
LRE30451SB / 03	LFRF0222	AB2LLGA

\* Check the Rating Model No.

**LG** HOUSEHOLD ELECTRIC RANGE  
 AC ONLY, 3WIRE-1PHASE, 60 Hz  
 MODEL NO.: LRE30451SW / 03 FOR USE ON 120/240 V OR 120/208 V  
 SERIAL NO.: 120/240 V : 11.2 kW  
 120/208 V : 8.9 kW  
 MANUFACTURED :  
**LG Electronics Inc.** 391-2 KAEIJUJEONG-DONG, CHANGWON CITY, KYUNGSAANGNAM-DO, KOREA

**UL**  
 LISTED  
 82NU  
 E254963

**LG** HOUSEHOLD ELECTRIC RANGE  
 AC ONLY, 3WIRE-1PHASE, 60 Hz  
 MODEL NO.: LRE30451SB / 03 FOR USE ON 120/240 V OR 120/208 V  
 SERIAL NO.: 120/240 V : 11.2 kW  
 120/208 V : 8.9 kW  
 MANUFACTURED :  
**LG Electronics Inc.** 391-2 KAEIJUJEONG-DONG, CHANGWON CITY, KYUNGSAANGNAM-DO, KOREA

**UL**  
 LISTED  
 82NU  
 E254963

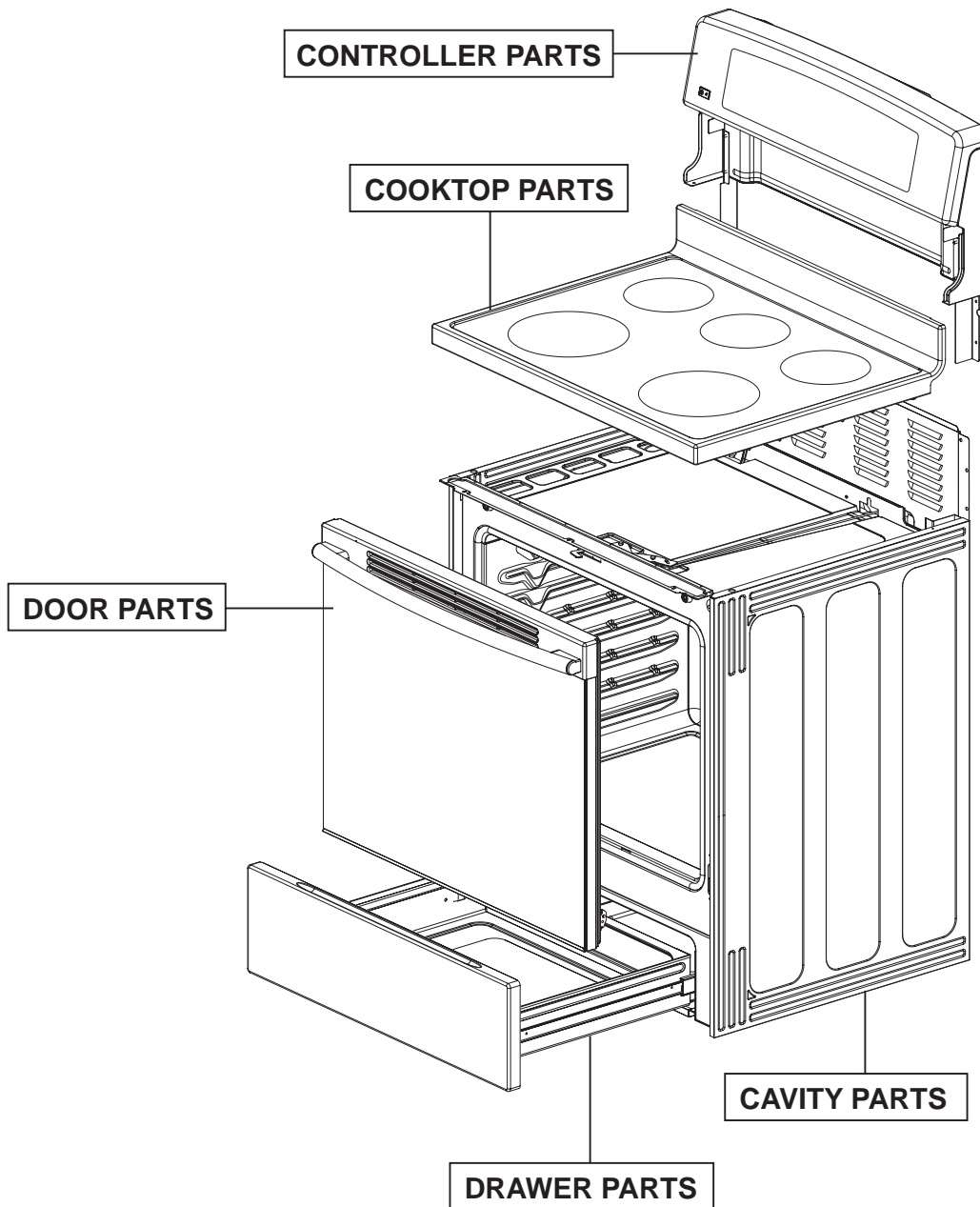



# CONTROLLER PARTS

For Model: LRE30451SW / SB / ST

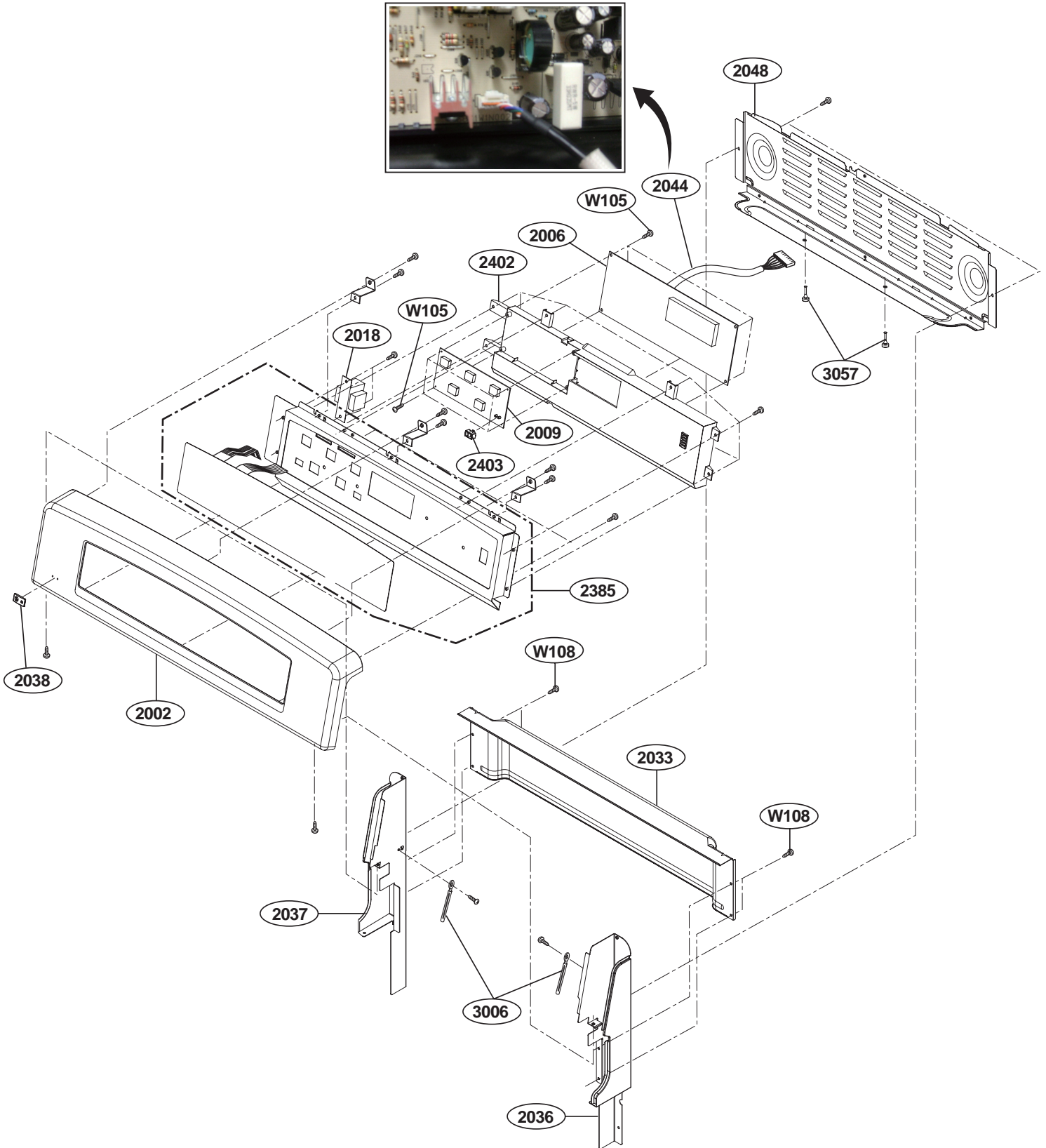

# COOKTOP PARTS (I)

**\* Check the Rating Model No.**

For Model: LRE30451SW / 01 / 02  
LRE30451SB / 01 / 02  
LRE30451ST / 01 / 02

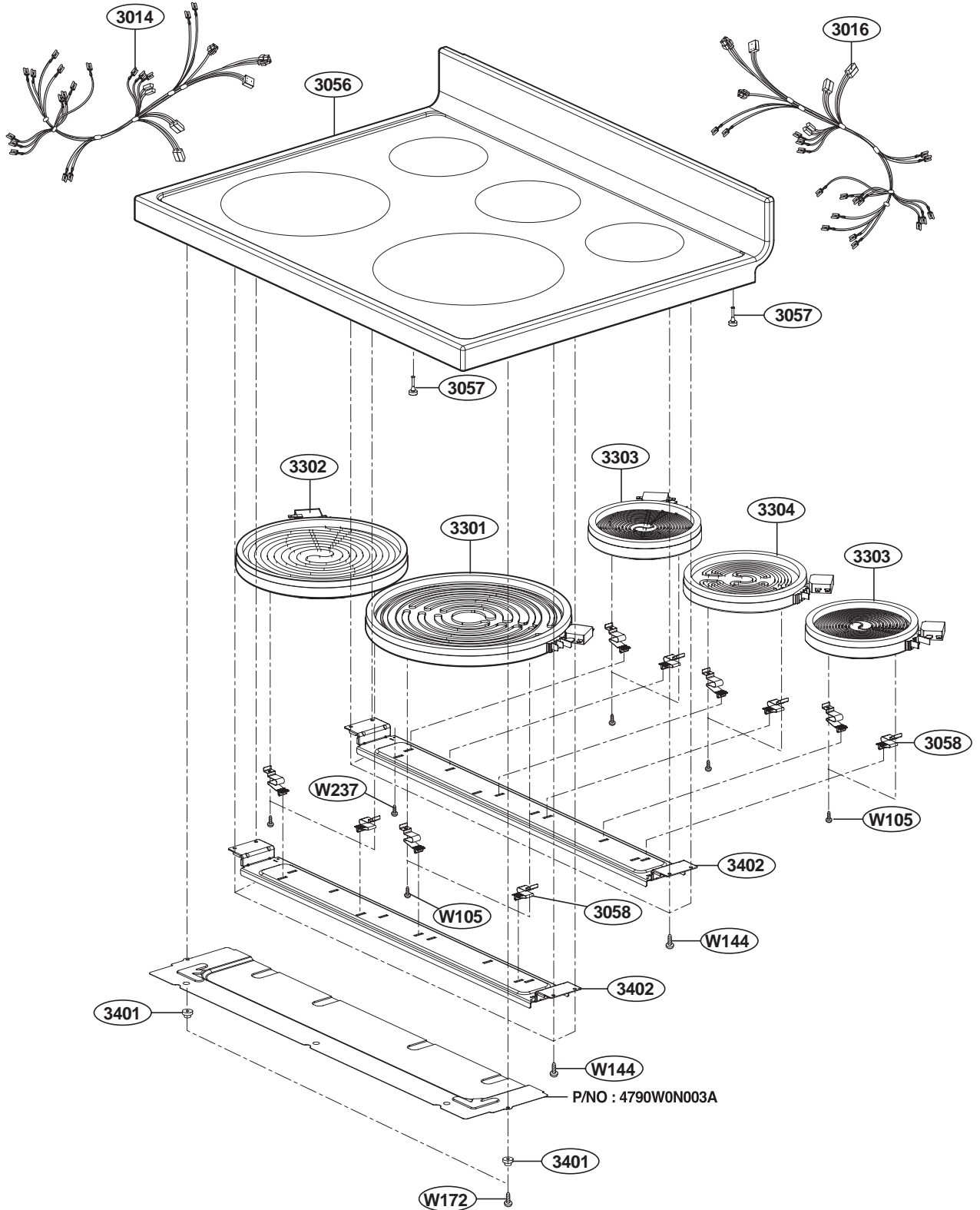

# DRAWER PARTS

For Model: LRE30451SW / SB / ST

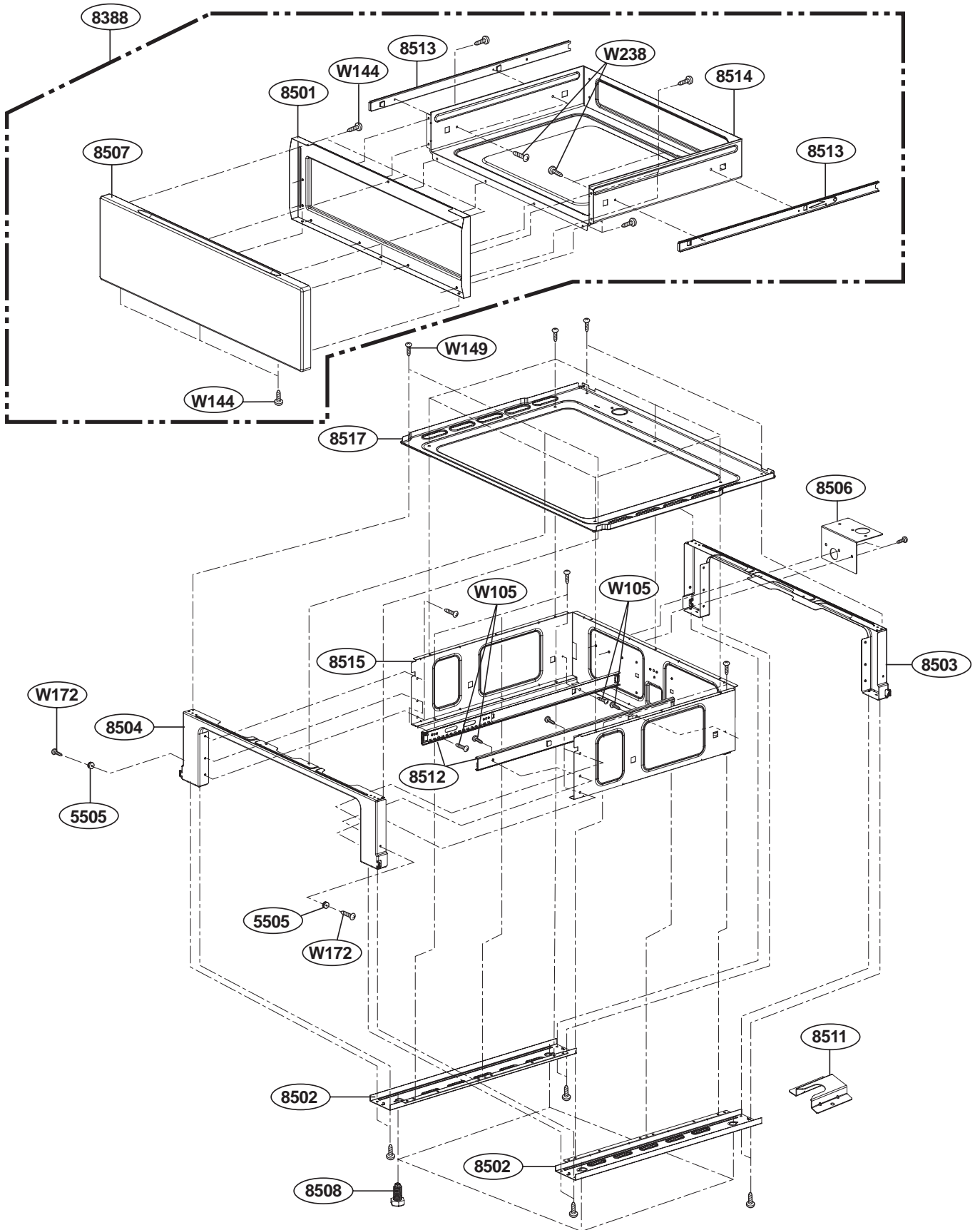

# CAVITY PARTS (II)

**\* Check the Rating Model No.**

**For Model: LRE30451SW / 01 / 02 / 03  
LRE30451SB / 01 / 02 / 03  
LRE30451ST / 01 / 02 / 03**

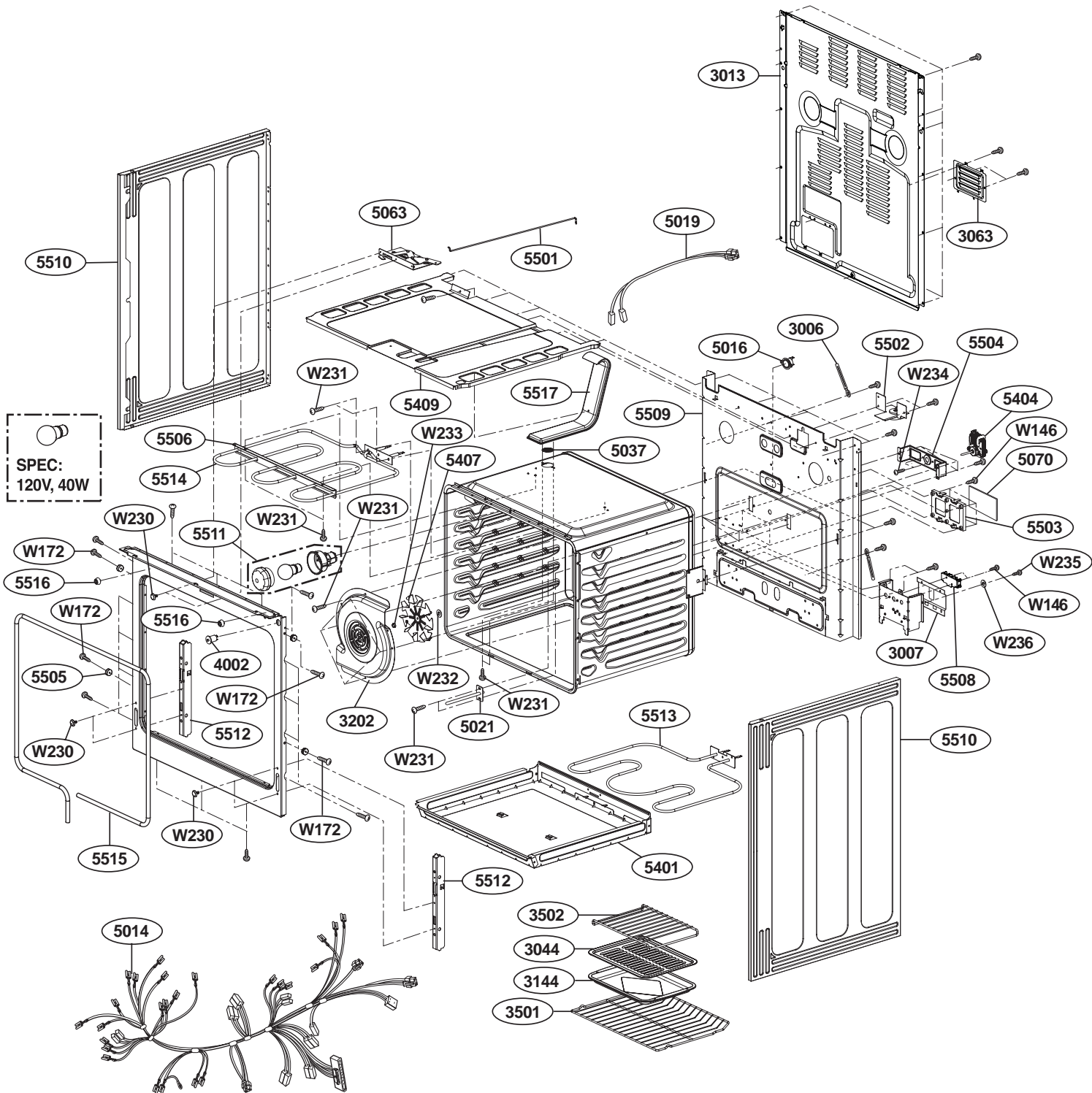



**LG Electronics Inc.**