



Internal Use Only



Website <http://biz.lgservice.com>

# 30" Freestanding Electric Range **SERVICE MANUAL**

**MODEL: LSC5683WW  
LSC5683WB  
LSC5683WS**

**CAUTION**

BEFORE SERVICING THE UNIT, READ THE SAFETY PRECAUTIONS IN THIS MANUAL.

P/NO : MFL38379704

April, 2008  
Printed in Korea

# FORWARD

This LG Service Manual, “ 30” Freestanding Self-Cleaning Electric Range,” provides the technician with information on the operation and service of the Freestanding Self-Cleaning Electric Range. It is to be used as a training Service Manual. For specific information on the model being serviced, refer to the “Owner’s Manual” or “Tech Sheet” provided with the electric range.

## SAFETY PRECAUTIONS

- Repairs of the appliance should be carried out by a licensed technician only. Wrong repairs may result in considerable danger. If you need repairs, contact an LG Service Center or your dealer.
- If the supply cord is defective, it must be replaced by a special cord or assembly available from manufacturer or substance or its service agent.
- Electrical leads and cables should not be allowed to touch the oven.
- Rating plate is located on the left side of warming drawer.
- The power supply of the appliance should be turned off when it is being repaired.

### **WARNING**

- **DISCONNECT power supply cord from the outlet before servicing.**
- **Replace all panels and parts before operating.**
- **RECONNECT all grounding devices.**
  - Failure to do so can result in severe personal injury, death or electrical shock.
- **DO NOT Touch when the oven operates.**
  - The interior parts will be very hot.

LG Electronics assumes no responsibility for any repairs made on our products by anyone other than Authorized Service Technicians.

# TABLE OF CONTENTS

	(PAGE)
<b>GENERAL</b> .....	<b>1-1 ~ 1-4</b>
• Important safety instructions .....	1-1 ~ 1-3
• Model & Serial number label and tech sheet locations .....	1-4
• Specifications .....	1-5
<b>THEORY OF OPERATION</b> .....	<b>2-1 ~ 2-5</b>
• General information .....	2-1
• Control panel features .....	2-2 ~ 2-5
- To turn on a single surface unit (Right Rear, Left Rear, Left Front)	
- To turn on a dual surface unit (Right Front)	
- To set the warming zone control	
- Setting the Clock	
- Start, Clean/Off and On/Off pad	
- To turn On/Off the oven light	
- Timer On/Off	
- Options pad: 7 types of category	
1) Convection auto conversion	
2) Thermostat adjustment	
3) Language selection (English or French)	
4) Preheating alarm light On/Off	
5) Beeper volume	
6) Temperature unit (°F or °C)	
7) Sabbath mode	
- Bake, Timed Bake, Delayed timed Bake	
- Broil	
- Convection Bake	
- Convection Roast	
- Favorites	
- Cook & Warm	
- Oven lockout	
- Changing hour mode on clock (12HR, 24HR)	
- Proof	
- Self-Clean	
- Warming drawer	
<b>COMPONENT ACCESS</b> .....	<b>3-1 ~ 3-17</b>
• Component Locations .....	3-1
• Removing the Back, Control Cover and Key Membrane, Support Assembly.....	3-2
• Removing the Control Power Supply and Power Control Board (PCB) .....	3-3
• Removing the Surface Element and the Ceramic Glass Cooktop .....	3-4
• Removing the Door Latch& the Door Switch .....	3-5
• Removing the BROIL element .....	3-6
• Removing the BAKE element .....	3-7
• Removing the CONVECTION element, Fan blade and Fan motor .....	3-8
• Removing the Oven light & Socket assembly .....	3-9
• Removing the latch drive assembly .....	3-10
- Door locking mechanism .....	3-10
• Removing the Oven temperature Sensor .....	3-11
• Removing the Warming drawer element & temperature sensor .....	3-12
• Removing & Replacing the Lift-off Oven Door .....	3-13
• Removing the Oven Door Handle & Glass .....	3-14 ~ 3-15
• Removing the Oven Door Gasket .....	3-16
• Removing a Side Panel .....	3-17

- COMPONENT TEST ..... 4-1 ~ 4-8**
  - Convection Motor ..... 4-1
  - Door locking Motor ..... 4-2
  - Micro Switch (normally open type) ..... 4-2
  - LVT ..... 4-2
  - Oven Sensor ..... 4-3
  - Warming Drawer Sensor ..... 4-3
  - Door switch ..... 4-3
  - Broil heater ..... 4-4
  - Bake heater ..... 4-4
  - Convection heater ..... 4-4
  - Warming Drawer heater ..... 4-4
  - Appliance outlet ..... 4-5
  - Appliance outlet circuit breaker ..... 4-5
  - Oven lamp ..... 4-5
  - Single surface unit(LF, LR, RR) ..... 4-6
  - Warming Zone ..... 4-7
  - Dual surface unit ..... 4-8
  
- COMPOSITION OF CONTROL ..... 5-1 ~ 5-4**
  - Main PCB ..... 5-2
  - Cook-top display PCB ..... 5-3
  - Cook-top relay PCB ..... 5-4
  - Oven relay PCB ..... 5-4
  
- CHECKING FLOW CHART BY FAILURE MODE ..... 6-1 ~ 6-11**
  - No display (No power) ..... 6-1 ~ 6-4
  - Oven does not heat ..... 6-5 ~ 6-7
  - Cook-top does not heat ..... 6-8 ~ 6-9
  - Oven lamp does not operate ..... 6-10
  - No key input ..... 6-11
  
- FAILURE CODES..... 7-0**
  
- CHECKING FLOW CHART BY F-CODE ..... 7-1 ~ 7-10**
  - F-1 error ..... 7-1
  - F-2 error ..... 7-2 ~ 7-4
  - F-3, F-4 error ..... 7-5 ~ 7-6
  - F-5, F-6 error ..... 7-7 ~ 7-8
  - F-9 error ..... 7-9 ~ 7-10
  
- TROUBLE SHOOTING ..... 8-1 ~ 8-3**
  
- SCHEMATIC DIAGRAM ..... 9-1**
  - STRIP CIRCUITS ..... 9-2 ~ 9-5
  
- EXPLODED VIEW ..... 10-1 ~ 10-9**
  
- REPLACEMENT PARTS LIST ..... 11-1 ~ 11-9**

# GENERAL

## IMPORTANT SAFETY INSTRUCTIONS

Read and follow all instructions before using your oven to prevent the risk of fire, electric shock, injury to person, or damage when using the range. This guide don't cover all possible conditions that may occur. For further assistance contact your service agent or manufacturer.



This is the safety alert symbol. This symbol alerts you to potential hazards that can kill or hurt you and others. All safety messages will follow the safety alert symbol and either the word "WARNING" or "CAUTION". These word means :



### **WARNING**

This symbol will alert you to hazards or unsafe practices which could cause serious bodily harm or death.



### **CAUTION**

This symbol will alert you to hazards or unsafe practices which could cause bodily injury or property damage.



### **WARNING**

- **DO NOT step or sit on the door and install the Anti-Tip Bracket packed with range.**
  - The range could be tipped and injury might result from spilled hot liquid, food, or the range itself.
  - If the range is pulled away from the wall for cleaning, service, or any other reason, ensure that the Anti-Tip Device is properly reengaged when the range is pushed back against the wall.
- **DISCONNECT power supply cord from the outlet before servicing.**
- **Replace all panels and parts before operating.**
- **RECONNECT all grounding devices.**
  - Failure to do so can result in severe personal injury, death or electrical shock.
- **DO NOT touch heating elements or interior surfaces of oven.**
  - Heating element may be hot even though they are dark in color.
  - Interior surfaces of an oven become hot enough to cause burns.
- **During and after use, do not touch, or let clothing or other flammable materials contact heating elements or interior surfaces of oven until they have had sufficient time to cool.**
  - Other surfaces of the appliance may become hot enough to cause burns among these surfaces are oven vent openings and surfaces near these openings, oven doors, and windows of oven doors.
- **DO NOT store items of interest to children in cabinets above a range or on the back guard of a range.**
  - Children climbing on the range to reach items could be seriously injured.



### **CAUTION**

- **Always use Pot Holders or oven mitts when removing food from the Warming Drawer.**
  - You can be burned as cookware and plates will be hot.
- **Be careful when you work on the electric range handling the sheet metal part.**
  - Sharp edge may be present and you can cut yourself.
- **Be careful not to bend the fan blade**
  - Failure to do so can result in vibration, noise, and poor performance of convection when operating.
- **Be careful not to scratch or chip the oven liner paint when you remove the oven light socket in the next step.**
- **Turn power OFF before removing the Warming Drawer.**
- **Be careful when removing and lifting the door.**
- **DO NOT lift the door by the handle.**
  - Failure to do so can result in personal injury as the door is very heavy.

# GENERAL

## IMPORTANT SAFETY INSTRUCTIONS

- Be sure your appliance is properly installed and grounded by a qualified technician.
- Do not repair or replace any part of the appliance unless specifically recommended in the manual. All other servicing should be referred to a qualified technician.
- Always disconnect power to appliance before servicing by removing the fuse or switching off the circuit breaker

### WARNING



- **DO NOT step or sit on the door and install the Anti-Tip Bracket packed with range.**



- The range could be tipped and injury might result from spilled hot liquid, food, or the range itself.
- If the range is pulled away from the wall for cleaning, service, or any other reason, ensure that the Anti-Tip Device is properly reengaged when the range is pushed back against the wall.

To reduce the risk of tipping of the range, the range must be secured by properly installed anti-tip devices. To check if the bracket is installed properly,

- **Warming drawer** : grasp the top rear edge of the Range and carefully attempt to tilt it forward. verify that the anti-tip devices are engaged.
- **Storage drawer** : Remove drawer and verify leveling leg is inserted into and fully secured by the anti-tip devices.

Refer to the installation manual for proper anti-tip bracket installation.

### WARNING

- **DO NOT touch heating elements or interior surfaces of oven.**
  - Heating element may be hot even though they are dark in color.
  - Interior surfaces of an oven become hot enough to cause burns.
- **During and after use, do not touch, or let clothing or other flammable materials contact heating elements or interior surfaces of oven until they have had sufficient time to cool.**
  - Other surfaces of the appliance may become hot enough to cause burns among these surfaces are oven vent openings and surfaces near these openings, oven doors, and windows of oven doors.

### WARNING

- **DO NOT store items of interest to children in cabinets above a range or on the back guard of a range.**
  - Children climbing on the range to reach items could be seriously injured.

# GENERAL

## IMPORTANT SAFETY INSTRUCTIONS

- **Do Not Leave Children Alone** - Children should not be left alone or unattended in area where appliance is in use. They should never be allowed to sit or stand on any part of the appliance.
- **Never Use Your Appliance for Warming or Heating the Room.**
- **Storage in or on Appliance** – Flammable materials should not be stored in an oven or near surface units. Be sure all packing materials are removed from the appliance before operating it. Keep plastics, clothes and paper away from parts of the appliance that may become hot
- **Wear Proper Apparel** – Loose-fitting or hanging garments should never be worn while using the appliance.
- **Do Not Use Water on Grease Fires** – Turn off oven to avoid spreading the flame. Smother the fire or flame by closing the door or use dry chemical, baking soda or foam- type extinguisher.
- **Use Only Dry Potholders** – Moist or damp potholders on hot surfaces may result in burns from steam.  
Do not let potholder touch hot heating elements. Do not use a towel or other bulky cloth.

### **WARNING**

- **DISCONNECT** power supply cord from the outlet before servicing.
- **Replace all panels and parts before operating.**
- **RECONNECT** all grounding devices.  
- Failure to do so can result in severe personal injury, death or electrical shock.

## SURFACE COOKING UNITS

- **Use Proper Pan Size** – This appliance is equipped with one or more surface units of different sizes. Select utensils having flat bottoms large enough to cover the surface unit heating element. The use of undersized utensils will expose a portion of the heating element to direct contact and may result in ignition of clothing. Proper relationship of utensil to burner will also improve efficiency.
- **Never Leave Surface Units Unattended at High Heat Settings** – Boil overs may cause smoking and greasy spillovers may ignite.
- **Make Sure Reflector Pans or Drip Bowls Are in Place** – Absence of these pans or bowls during cooking may subject wiring or components underneath to damage.
- **Protective Liners** – Do not use aluminum foil to line surface unit drip bowls or oven bottoms, except as suggested in the manual. Improper installation of these liners may result in a risk of electric shock, or fire.
- **Glazed Cooking Utensils** – Only certain types of glass, glass/ceramic, ceramic, earthenware, or other glazed utensils are suitable for range-top service without breaking due to the sudden change in temperature.
- **Utensil Handles Should Be Turned Inward and Not Extend Over Adjacent Surface Units** – To reduce the risk of burns, ignition of flammable materials, and spillage due to unintentional contact with the utensil, the handle of a utensil should be positioned so that it is turned inward, and does not extend over adjacent surface units.
- **Do Not Soak Removable Heating Elements** – Heating elements should never be immersed in water.
- Be sure you know which control pads operate each surface unit. Make sure you turned on the correct surface unit.

## SELF-CLEAN OVENS

- **Do Not Clean Door Gasket** – The door gasket is essential for a good seal. Care should be taken not to rub, damage, or move the gasket.
- **Do Not Use Oven Cleaners** – No commercial oven cleaner or oven liner protective coating of any kind should be used in or around any part of the oven.
- **Clean in the self-clean cycle only parts listed in this manual.** Before self-cleaning the oven, remove the broiler pan and any utensils from the oven.
- **Never keep pet birds in the kitchen** – the health of birds is extremely sensitive to the fumes released during an oven self-clean cycle. Fumes may be harmful or fatal to birds. Move birds to well-ventilated room.
- **Important Instruction** – In the event the self-clean mode “F” code goes on, or three long beeps sound, oven is malfunctioning in the self-clean mode. Turn off or disconnect appliance from power supply and have serviced by a qualified technician.

## VENTILATING HOODS:

- **Clean Ventilating Hoods Frequently** – Grease should not be allowed to accumulate on hood or filter.
- **When flaming foods under the hood, turn the fan on.**

## OVEN

- **Use Care When Opening Door** – Let hot air or steam escape before you remove or replace food in the oven
- **Do Not Heat Unopened Food Containers** – Build-up of pressure may cause container to burst and result in injury.
- **Keep Oven Vent Ducts Unobstructed** – the oven vent is located above the left rear surface unit. this area could become hot during oven use. Never block this vent and never place plastic or heat-sensitive items on vent
- **Placement of Oven Racks** – Always place oven racks in desired location while oven is cool. If rack must be moved while oven is hot, do not let potholder contact hot heating element in oven.
- **Do Not** allow aluminum foil or meat probe to contact heating elements.

## GLASS/CERAMIC COOKING SURFACES

- **Do Not Cook on Broken Cook-Top** – If cook-top should break, cleaning solutions and spillovers may penetrate the broken cook-top and create a risk of electric shock. Contact a qualified technician immediately.
- **Clean Cook-Top With Caution** – If a wet sponge or cloth is used to wipe spills on a hot cooking area, be careful to avoid steam burn. Some cleaners can produce noxious fumes if applied to a hot surface.

## DEEP FAT FRYERS:

- Use extreme caution when moving the grease kettle or disposing of hot grease.

# GENERAL

## MODEL & SERIAL NUMBER LABEL AND TECH SHEET LOCATIONS

The Model/Serial Number label and Tech Sheet locations are shown below.

Model & Serial  
Number Location



Tech Sheet Location  
(On Low Rear Cover)





# GENERAL

## SPECIFICATIONS

Model Number		LSC5683WW / LSC5683WB / LSC5683WS
<b>Category</b>		Convection
<b>Overall</b>	Width	30"
	Installation type	Freestanding
	Color availability	WH, BK, STS
<b>Control</b>	Oven	Keypad
	Cooktop	Keypad
	Display	Scroll VFD
	Electronic clock & timer	Yes
	Control lock capability	Yes
	Audible preheat signal	Yes
	Special function	Option(7 categories) 1. Convection auto conversion On/Off 2. Thermostat Adjustment 3. Language -English or French 4. Preheating alarm light On/Off 5. Beeper Volume (loud, normal, low, mute) 6. Temperature unit (F / C) 7. Sabbath mode
<b>Cooktop</b>	Material	Ceramic glass
	# of element	5
Power	LR	6"-1,200
	RR	6"-1,200
	CR	warming zone
	LF	9"-2,500
	RF	Dual (9"/12"-1,700/2,700)
<b>Oven</b>	Capacity(cu.ft)	<b>5.6</b>
	Broil element	4000 watts
	Bake element	3400 watts
	Convection System	Yes
	-Convection element	Yes (800w, 120v)
	# of Racks	3 (2 standard, 1 Split)
	Interior oven light	120V, 40Watts
	Proof	Yes
	Cook & warm	Yes
	Favorites	Yes 1. Bread 2. Meat 3. Chicken
	Door lockout	Yes
	Broiler pan	Yes
<b>Drawer</b>	Type	Warming drawer
	Element	600 watts
	Warming rack	Yes
<b>Dimensions (inch)</b>	Oven Interior(W x H x D)	24 1/2 x 20 1/4 x 19 3/8
	Exterior - Width	29 7/8
	Exterior - Height	36 (cooktop), 47 5/8 (backguard top)
	Exterior - Depth	25 11/16 (Door), 28 (with handle)
	Net weight (Kg)	82 kg (181lbs)
<b>Power</b>	Rating	57A(120/240V) / 50A(120/208V)

# THEORY OF OPERATION

## GENERAL INFORMATION

### Rating Label

Model numbers are recorded on the rating label. Rating label is located on the lower front left corner of the oven frame. It can be seen by opening the storage drawer or warming drawer. Before ordering parts, write down the correct model and serial number from rating label. This avoids incorrect shipments and delays. Please refer to parts reference material when ordering replacement parts.

### Functional Operation

#### Bake Mode

Top and hidden bottom elements operate during bake. Bake can be used to cook foods which are normally baked. Oven must be preheated.

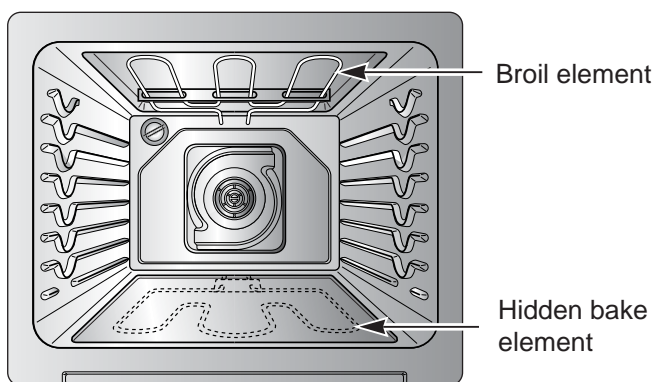

#### Broil Mode

Top element operates during broil. Broil can be used to cook foods which are normally broiled. Preheating is not required when using broil. All foods should be turned at least once except fish, which does not need to be turned.

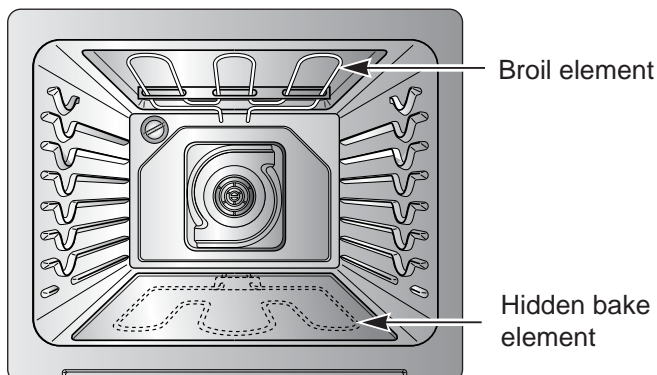

#### Convection Bake / Roast Mode

Upper element, lower element, Rear element (some model) and fan operate during convection bake. Convection bake should be used for cooking casseroles and roasting meats. Oven should be preheated for best results when using convection bake. Pans do not need to be staggered. Cooks approximately 25% quicker than bake.

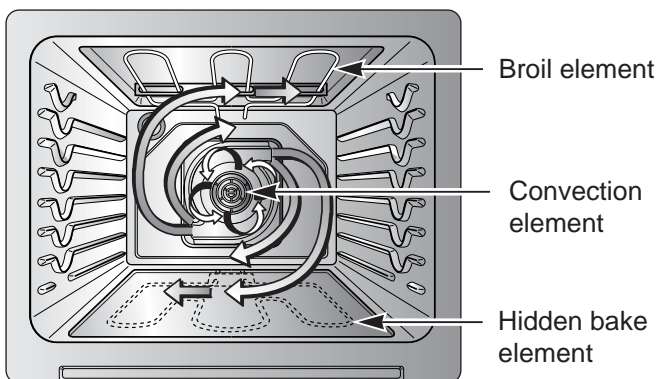

#### Cooking Guide

Refer to owners manual, for following recommendations only as a guide for times and temperature. Times, rack position, and temperatures may vary depending on conditions and food type. For best results, always check food at minimum time. When roasting, choose rack position based on size of food item.

# THEORY OF OPERATION

## CONTROL PANEL FEATURES

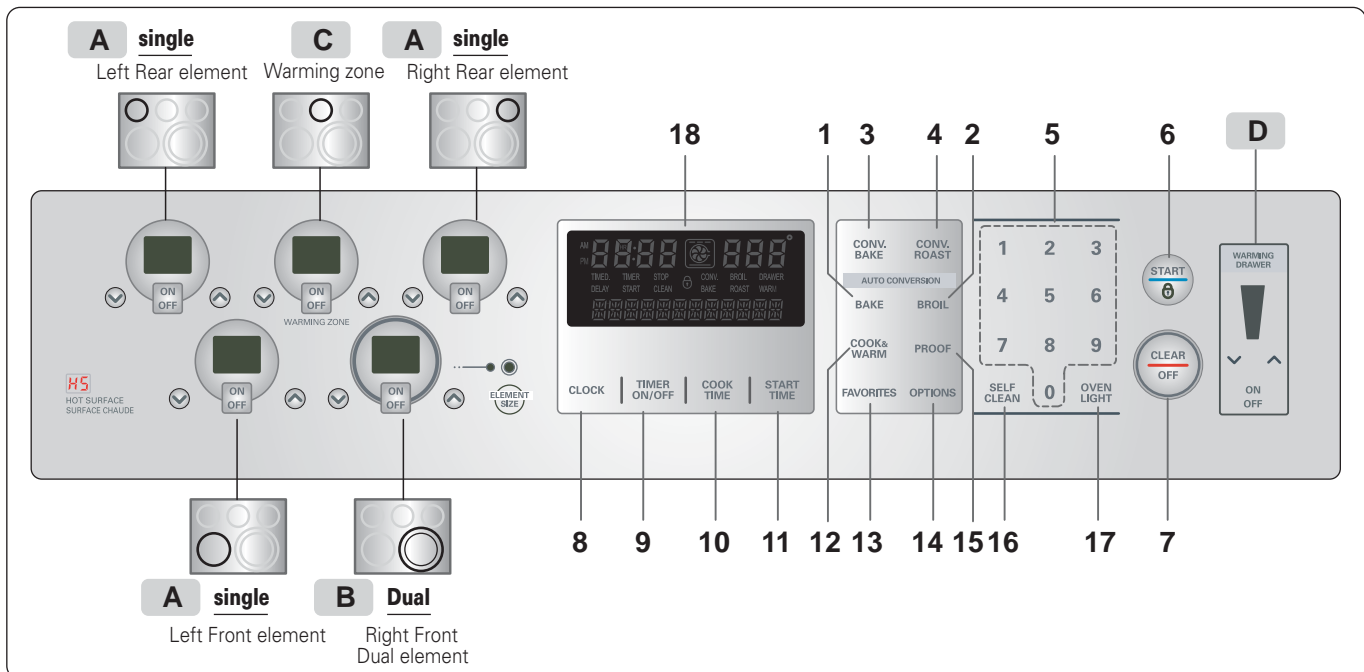

1. **BAKE PAD:** Press to select the bake function.
2. **BROIL PAD:** Press to select the broil function.
3. **CONVECTION BAKE PAD:** Press to select baking with the convection function.
4. **CONVECTION ROAST PAD:** Press to select roasting with the convection function.
5. **NUMBER PADS:** Use to set any function requiring numbers such as the time of day on the clock, the timer, the oven temperature, the start time and length of operation for timed baking.
6. **START PAD:** Must be pressed to start any cooking or cleaning function.
7. **CLEAR/OFF PAD:** Press to cancel all oven operations except the clock and timer.
8. **CLOCK PAD:** Press before setting the time of day.
9. **TIMER ON/OFF PAD:** Press to select the timer feature.
10. **COOK TIME PAD:** Press and then use the number pads to set the amount of time you want your food to cook. The oven will shut off when the cooking time has run out.
11. **START TIME PAD:** Use along with BAKE, CONV. BAKE, CONV. ROAST, COOK TIME and SELF CLEAN pads to set the oven to start and stop automatically at a time you set.

12. **COOK & WARM PAD:** Press to keep cooked foods warm. See the how to set the oven for warming section.
13. **FAVORITES PAD:** Press to set favorite cooking.
14. **OPTIONS PAD:** Press to set 7 types of option category.
15. **PROOF PAD:** Press to select a warm environment useful for rising yeast-leavened products.
16. **SELF CLEAN PAD:** Press to select self-cleaning function. See the using the Self-Clean Oven section.
17. **OVEN LIGHT PAD:** Press to turn the oven light on or off.
18. **DISPLAY**

**A Single surface unit**  
: Right Rear, Left Rear, Left Front

**B Dual surface unit** : Right Front

**C Warming Zone** : Center Rear

**D Warming Drawer**

# THEORY OF OPERATION

## A To turn on a single surface unit (Right Rear, Left Rear, Left Front)



1. Press **ON/OFF** pad for the desired element.
2. Press ( / ) pad to choose the desired setting.

## B To turn on a dual surface unit (Right Front)



1. Press **ON/OFF** pad
2. Press the **ELEMENT SIZE** pad as needed to select the desired burner size. Default size is 9". When first selected, 12" size is ON. The light above the **ELEMENT SIZE** pad indicates which size surface unit is on.
2. Press ( / ) pad to choose the desired setting.

### Note:

- Each time a pad is pressed a beep will sound.
- The power level decreases or increases by **0.5** from **9.0** through **3.0**. (by **0.2** from **3.0** through **1.0**)
- **Lo** is the lowest power level available.
- "HS" will appear when the unit is hot to touch

## C To set the warming zone control



1. Press **ON/OFF** pad at the warming zone.
2. Press ( / ) pad to choose the desired setting.

### Note:

- Each time a pad is pressed a beep will sound.
- The controls for the warming zone allow for 5 different heat settings : **Lo~Hi**
- "HS" will appear when the unit is hot to touch.

## 1. SETTING THE CLOCK



## 2. START, CLEAN/OFF AND ON/OFF PAD

1. Touch **START** pad to start oven.
2. Touch **CLEAR/OFF** pad to cancel a program during cooking or Erase during programming.
3. Touch **ON/OFF** pad to start or cancel the surface unit.

## 3. TO TURN ON/OFF THE OVEN LIGHT

The oven light automatically turns ON when the Door is opened. The oven light may also be Manually turned ON or OFF by pressing the **OVEN LIGHT** pad

**Note:** The oven light cannot be turned on if self-clean feature is active.

## 4. TIMER ON/OFF

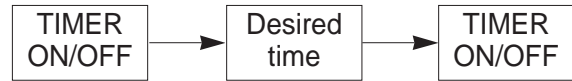

To cancel timer at any time, touch **TIMER ON/OFF** pad.

### Note:

1. If you press **TIMER ON/OFF** pad once, it allows you to make a "second" unit of timer setting.  
(for example: if you press "5" and "6", it means 56 seconds)
2. If you press **TIMER ON/OFF** pad twice, it allows you to make a "minute" unit of timer setting.  
(for example: if you press "5" and "6", it means 56 minutes)

## 5. OPTIONS PAD: 7 types of category

### 1) CONVECTION AUTO CONVERSION

1. Press **OPTIONS** pad **once**
2. Press "1" pad for **ENABLE** or "2" pad for **DISABLE**
3. Press **START** pad.

### 2) THERMOSTAT ADJUSTMENT

The oven temperature can be adjusted from -35°F (-19°C) to 35°F (19°C).

**Note:** The thermostat adjustments made with this feature will just change Bake, Convection Bake and Convection Roast temperature.

### To increase the oven temperature:

1. Press **OPTIONS** pad twice
2. Press the **desired temperature**
3. Press **START** pad.

### To decrease the oven temperature:

1. Press **OPTIONS** pad twice
2. Press the **desired temperature**
3. Press the **OPTIONS** pad once
4. Press **START** pad

### 3) LANGUAGE SELECTION (English or French)

1. Press **OPTIONS** pad 3 times
2. Press "1" pad for **ENGLISH** or "2" pad for **FRENCH**
3. Press **START** pad

### 4) PREHEATING ALARM LIGHT ON/OFF

1. Press **OPTIONS** pad 4 times
2. Press "1" pad for **ON** or "2" pad for **OFF**
3. Press **START** pad

# THEORY OF OPERATION

## 5) BEEPER VOLUME

1. Press **OPTIONS** pad **5 times**
2. Press “**1**” pad for **loud** level,  
“**2**” pad for **normal** level,  
“**3**” pad for **low** level,  
“**4**” pad for **mute** level,
3. Press **START** pad

## 6) TEMPERATURE UNIT (°F or °C)

1. Press **OPTIONS** pad **6 times**
2. Press “**1**” pad for °F  
or “**2**” pad for °C
3. Press **START** pad

## 7) SABBATH MODE

1. Press **OPTIONS** pad **7 times** and then  
press “**1**” pad to set sabbath feature enable
2. Press **START** pad
3. Set the **BAKE** (or **Timed BAKE**, **Delay  
Timed Bake**)
4. Press **START** pad
5. Press and hold the **OPTIONS** pad for 3 seconds
6. Press “**1**” pad to set sabbath “**ON**”

### To Cancel SABBATH mode

1. Press **OPTIONS** pad for 3 seconds
2. Press “**2**” pad to set sabbath mode “**OFF**”
3. Press **START** pad.

**Note:** You may change the oven temperature once baking has started. Press **BAKE**, enter the oven temperature change (170 to 550F °) and press **START** (For Jewish Holidays only). Remember that the oven control will no longer beep or display any further changes once the oven is set for the Sabbath feature.

## 6. BAKE, TIMED BAKE, DELAYED TIMED BAKE

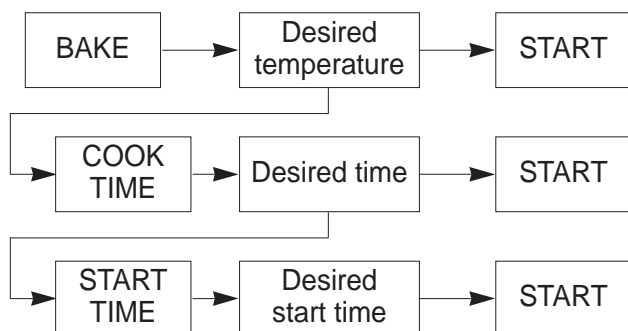

## 7. BROIL



## 8. CONVECTION BAKE



## 9. CONVECTION ROAST



## 10. FAVORITES

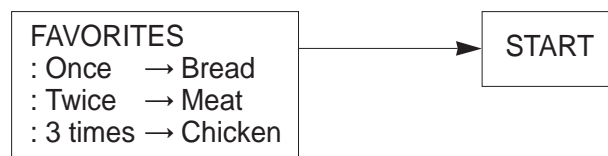

## 11. COOK & WARM



## 12. OVEN LOCKOUT

Press and hold the **START** pad for 3 seconds (to activate or reactivate LOCKOUT)

## 13. CHANGING HOUR MODE ON CLOCK (12HR, 24HR)

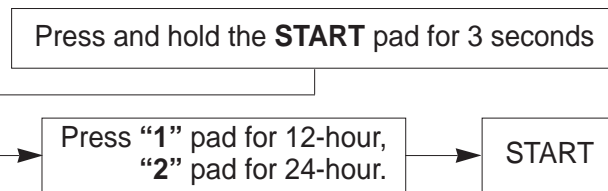

## 14. PROOF



## 15. SELF-CLEAN

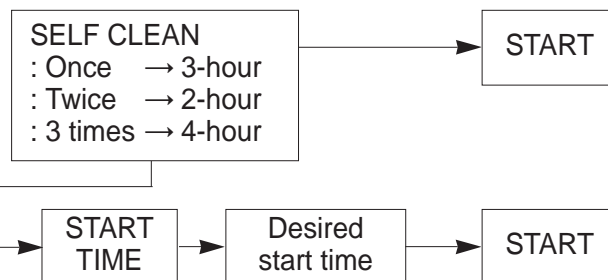

# THEORY OF OPERATION

## WARMING DRAWER

### The rack can be used in 2 ways:

- In the **upright position** to allow low profile food items to be placed both under and on top of the rack (for example, rolls or biscuits on top of the rack and a casserole dish underneath).
- In the **downward position** to allow you to place light weight food items and empty cookware (for example, rolls or pastries and dinner plates) on the rack. Set the Warming Drawer rack in either position as shown below (Fig.1).

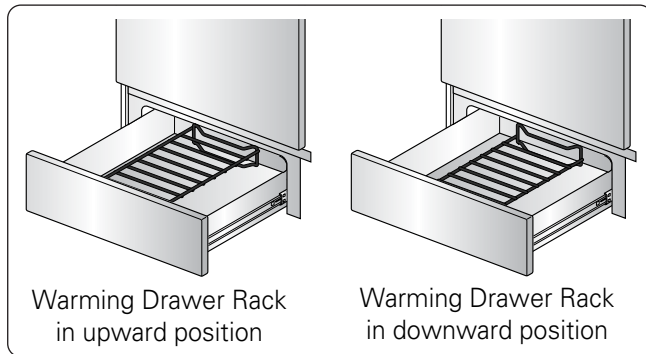

### **! CAUTION**

- **Always use Pot Holders or oven mitts when removing food from the Warming Drawer.**
  - You can be burned as cookware and plates will be hot.

### To Operate the Warming Drawer

The purpose of the Warming Drawer is to keep hot cooked foods at serving temperature. Always start with hot food. It is not recommended to heat cold food in the Warming Drawer.

All food placed in the Warming Drawer should be covered with a lid or aluminum foil to maintain quality. Do not use plastic wrap to cover food. Plastic may melt onto the drawer and be very difficult to clean. Use only utensils and cookware recommended for oven use in the Warming Drawer.

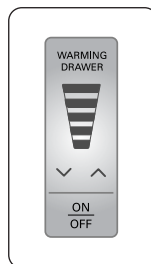

Warming Drawer Control

### To set the warming drawer control

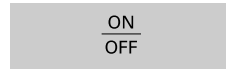

1. Press the **ON/OFF** pad at the **WARMING DRAWER** position. The indicator light will flash.

(If no further pads are pressed within 25 seconds, the display will clear.)



2. Press (∧) once to turn on the power level for high(5 level) or (∨) for Low(1 level).



3. Use the (∨)/(∧) pad to choose the desired power setting. (Adjustable at any time while the Drawer is ON.)

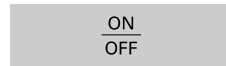

4. When the food is ready for removal, press the **ON/OFF** pad once to turn off.

Note: The Warming Drawer will shut off automatically after 3 hours.

# COMPONENT ACCESS

This section instructs you on how to service each component inside the range. The components and their locations are shown below.

## COMPONENT LOCATIONS

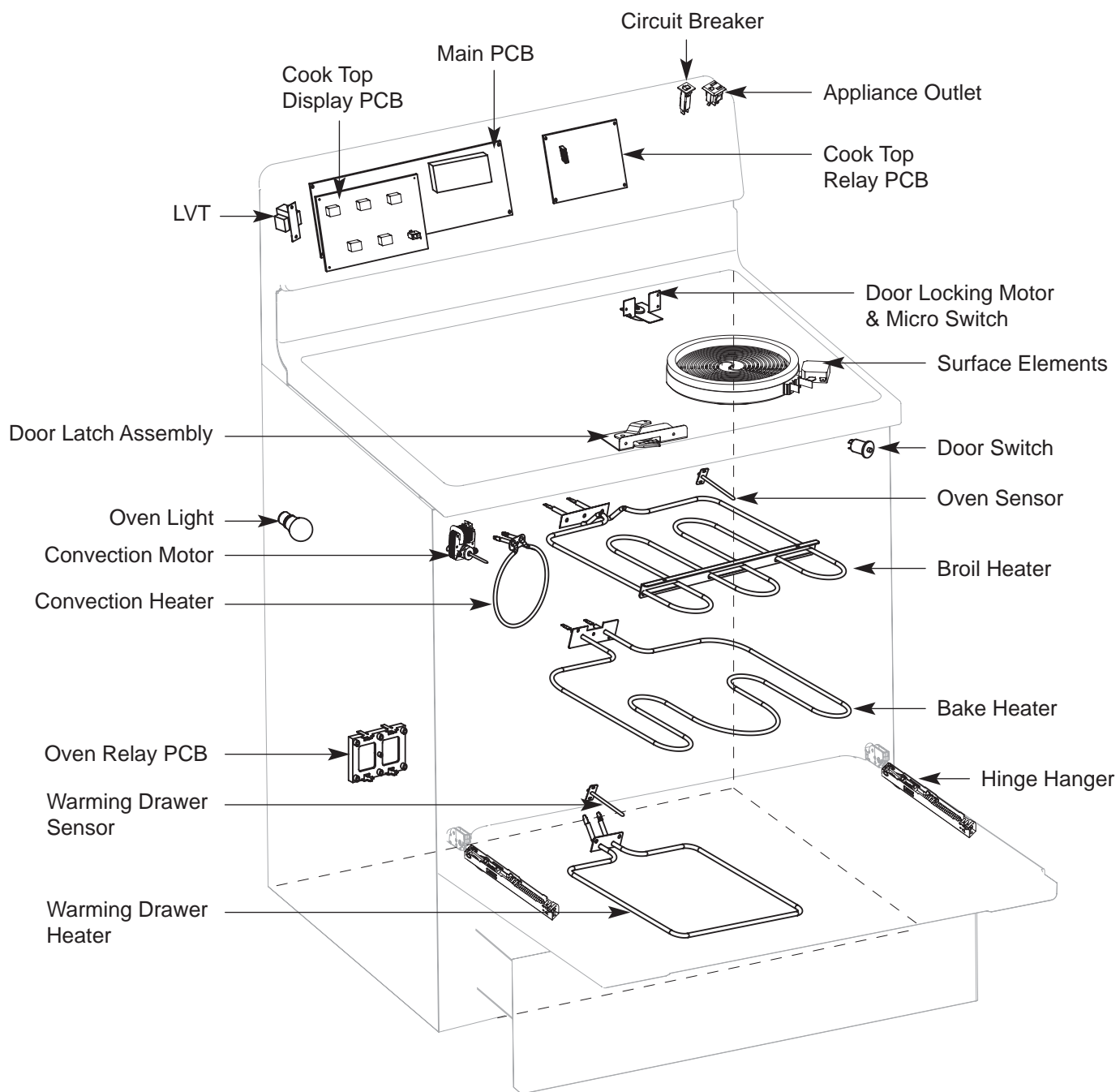

# COMPONENT ACCESS

## REMOVING THE BACK, CONTROL COVER AND KEY MEMBRANE, SUPPORT ASSEMBLY

### ⚠ WARNING

- **DISCONNECT** power supply cord from the outlet before servicing.
- **Replace** all panels and parts before operating.
- **RECONNECT** all grounding devices.
  - Failure to do so can result in severe personal injury, death or electrical shock.

### ⚠ CAUTION

- **Be careful** when you work on the electric range handling the sheet metal part.
  - Sharp edge may be present and you can cut yourself.

1. Turn off the electrical supply going to the range.
2. Pull the range away from the wall so that you can access the rear panel.
3. Remove the 3 screws from the rear control cover and remove the cover.
4. Remove the 17 screws from the rear back cover and remove the cover.

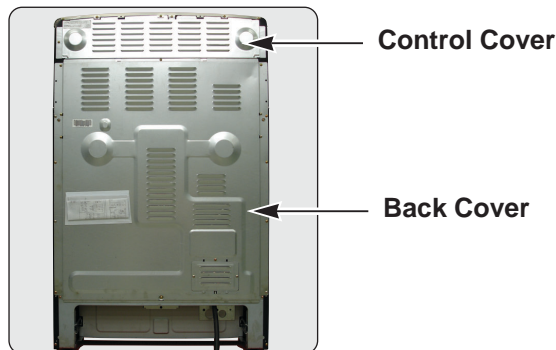

5. Remove the 5 screws of PCB assembly and separate PCB assembly after unplugging the connectors.

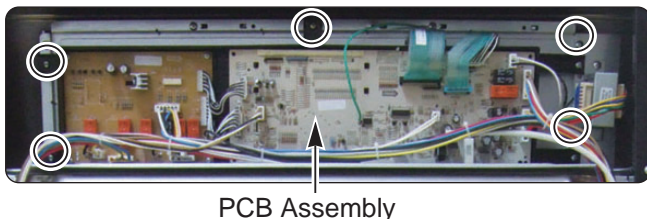

6. Remove 7 screws of KEY Membrane assembly and separate PCB assembly.



7. Remove the 4 screws of the controller sub assembly from the supporters.

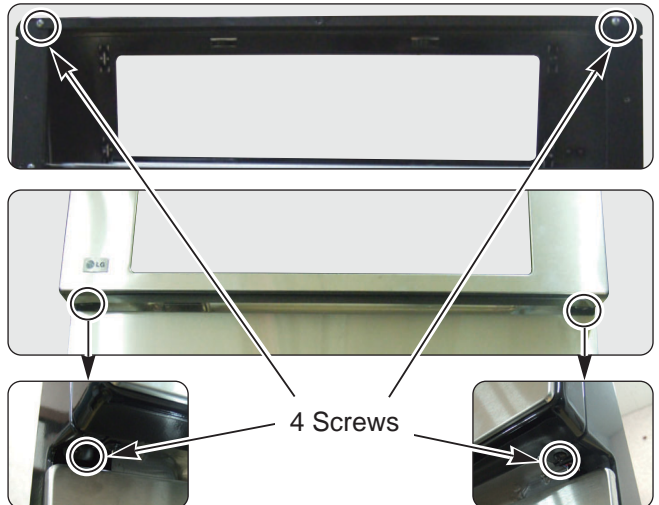

8. Pull the controller sub assembly and lift it up from the supporters.

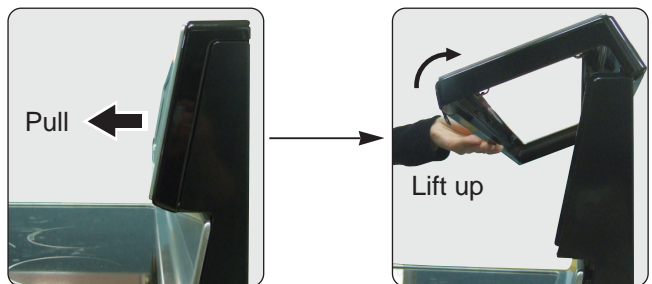

9. For servicing the KEY Membrane, the controller sub assembly should be separated in whole.





# COMPONENT ACCESS

## REMOVING THE CONTROL POWER SUPPLY AND POWER CONTROL BOARD (PCB)

### **⚠ WARNING**

- **DISCONNECT** power supply cord from the outlet before servicing.
- **Replace** all panels and parts before operating.
- **RECONNECT** all grounding devices.
  - Failure to do so can result in severe personal injury, death or electrical shock.

### **⚠ CAUTION**

- **Be careful** when you work on the electric range handling the sheet metal part.
  - Sharp edge may be present and you can cut yourself.

1. Turn off the electrical supply going to the range.
2. Pull the range away from the wall so that you can access the rear panel.
3. Remove back cover & control cover (See step 3~4 on page 3-2)

4. There is 3 PCB (power control board). When you check PCB, check the proper pcb of default mode and check main pcb.

**NOTE:** Refer to the page 5-1~5-4 for composition of control board

Cook-top Relay PCB    Main PCB

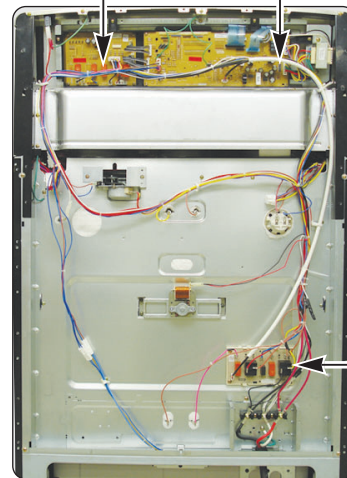

5. **To remove the control power supply:**
  - a) Disconnect 2 connectors.
  - b) Remove the two screws.

2 Connector

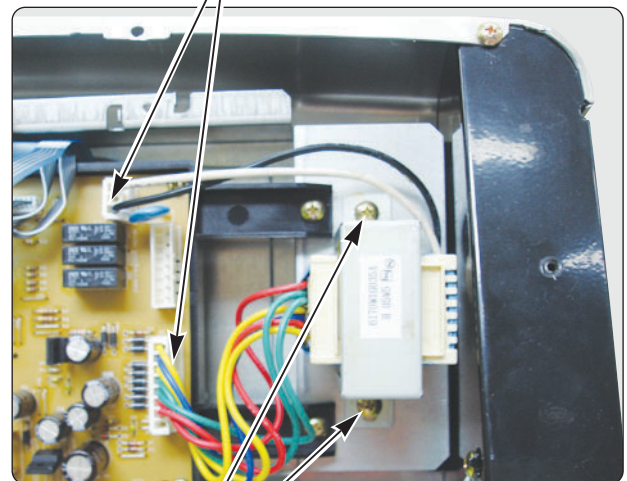

2 Screws

# COMPONENT ACCESS

## REMOVING THE SURFACE ELEMENTS AND THE CERAMIC GLASS COOKTOP

### **⚠ WARNING**

- **DISCONNECT** power supply cord from the outlet before servicing.
- **Replace** all panels and parts before operating.
- **RECONNECT** all grounding devices.
  - Failure to do so can result in severe personal injury, death or electrical shock.

### CERAMIC GLASS COOKTOP REMOVAL

#### Step. 1

Unplug the cord or disconnect power

#### Step. 2

Open oven door and remove the 3 screws located at the front of the cook-top, then close the door.

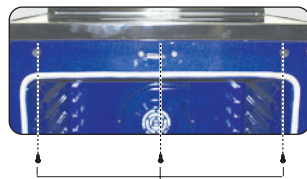

#### Step. 3

Lift up the cooktop front and Remove the ground screw securing ground wire



#### Step. 4

Slightly lift up and pull up the cook-top and then unplug the 2 connectors at the back by squeezing side tabs

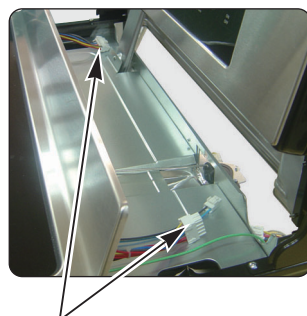

#### Step. 5

Turn over the cook-top assembly



#### Step. 6

To remove the surface elements

- Remove the wires from the element and limiter terminals.
  - Remove the element bracket screw (shown above) for the element you are servicing.
  - Carefully lift the bottom of the bracket just far enough to remove the element.
- d) Carefully lift the bottom of the bracket just far enough to remove the element.

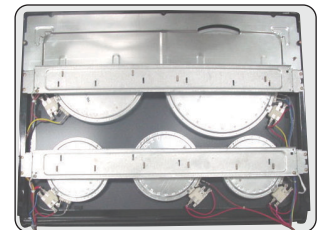

**REASSEMBLY NOTE:** When you reinstall the element make sure that the wires are inserted into the correct tap then reinstall the bracket screw to secure it to the cooktop.

# COMPONENT ACCESS

## REMOVING THE DOOR LATCH & DOOR SWITCH

### **⚠ WARNING**

- **DISCONNECT** power supply cord from the outlet before servicing.
- **Replace all panels and parts before operating.**
- **RECONNECT** all grounding devices.
  - Failure to do so can result in severe personal injury, death or electrical shock.

### **⚠ CAUTION**

- **Be careful when you work on the electric range handling the sheet metal part.**
  - Sharp edge may be present and you can cut yourself.

1. Turn off the electrical supply going to the range.
2. Open the oven door.
3. Raise the cooktop (see page 3-4 for the procedure).
4. To remove the door latch:
  - a) Remove the two screws from the door latch and remove the latch.



2 Screws

- b) Remove the door latch from the burner box and unhook the actuating rod.

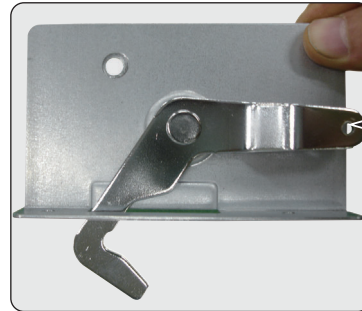

Unhook Actuating Rod

5. To remove the door switch:
  - a) If not already done, raise the cooktop (see page 3-4 for the procedure).
  - b) Remove the door switch from the range. To do this, use a ratchet extension or a small socket, and tap it out of the hole with a hammer.

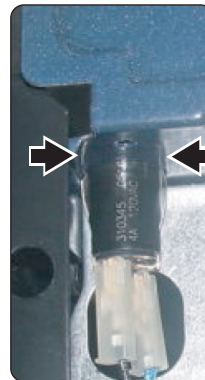

- c) Disconnect the wires from the terminals.

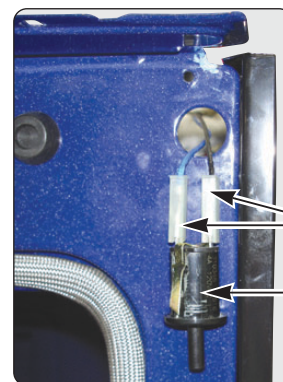

Wires

Door Switch

# COMPONENT ACCESS

## REMOVING THE BROIL ELEMENT

### **⚠ WARNING**

- **DISCONNECT** power supply cord from the outlet before servicing.
- **Replace all panels and parts before operating.**
- **RECONNECT** all grounding devices.
  - Failure to do so can result in severe personal injury, death or electrical shock.

### **⚠ CAUTION**

- **Be careful when you work on the electric range handling the sheet metal part.**
  - Sharp edge may be present and you can cut yourself.

- b) Pull the element forward so that you can access the terminals and disconnect the wires.

2 Terminals

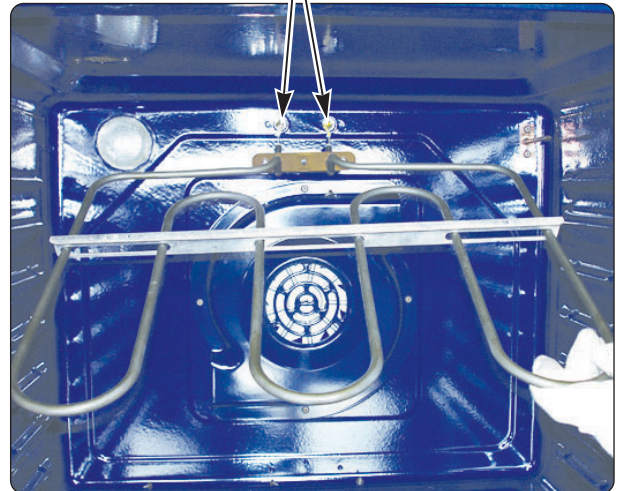

1. Turn off the electrical supply going to the range.
2. Open the oven door and remove the racks from inside the oven.
3. **To remove the broil element:**
  - a) Remove the 4 screws from the front and rear brackets.

2 Upper bracket Screws

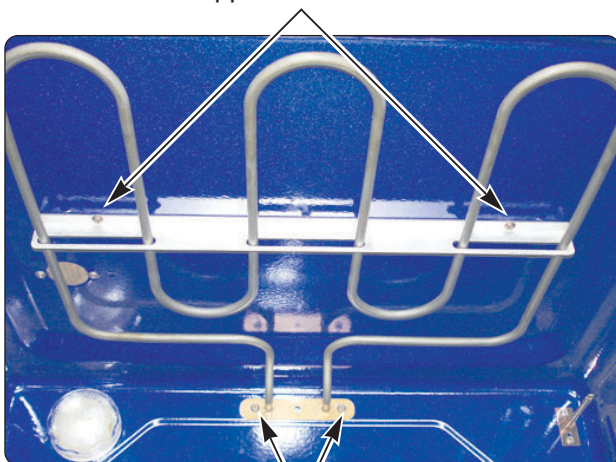

2 Rear bracket Screws

# COMPONENT ACCESS

## REMOVING THE HIDDEN BAKE ELEMENT

1. Unplug range of disconnect power.
2. Pull the range out of its mounting location so that you can access the rear of the unit.
3. Remove the rear panel from the unit.  
(See step 3 on page 3-2 for procedure)

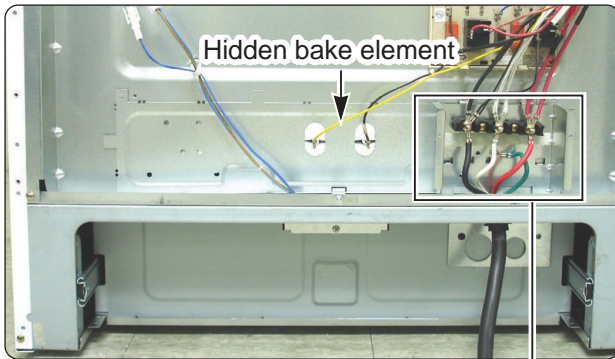

4. Remove the 2 screws of power cord assembly box and 1 ground screw.
5. Set the box aside

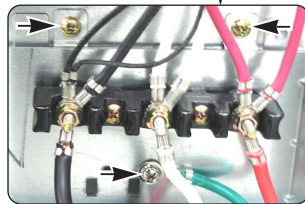

6. Cut the 9 points of flange and remove the bake heater cover.

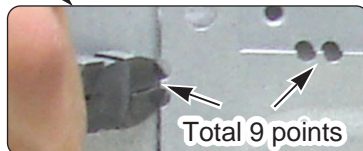
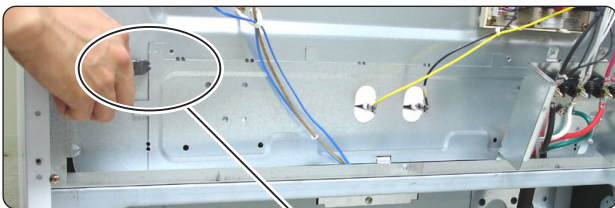

7. Bend the insulation glass fiber up.

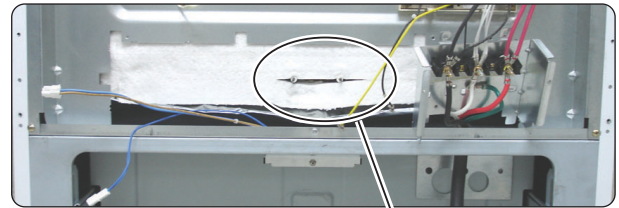

8. Remove two screws and bend up two flanges

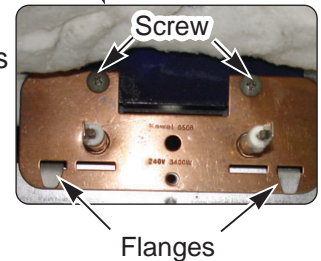

9. Carefully pull the hidden bake element and its mounting bracket out of the range.

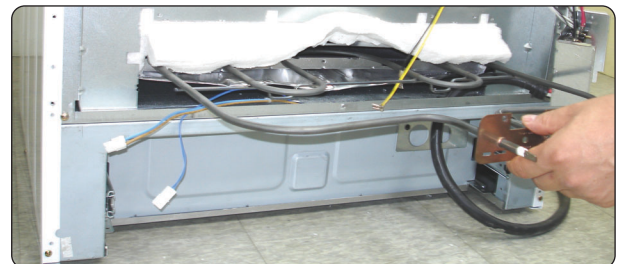

# COMPONENT ACCESS

## REMOVING THE CONVECTION ELEMENT, FAN BLADE AND FAN MOTOR

1. Disconnect power and remove oven racks.
2. Pull the range out of its mounting location so that you can access the rear of the unit.
3. Remove the rear panel from the unit.  
(See step 3~4 on page 3-2 for procedure)
4. Disconnect the wire connection.

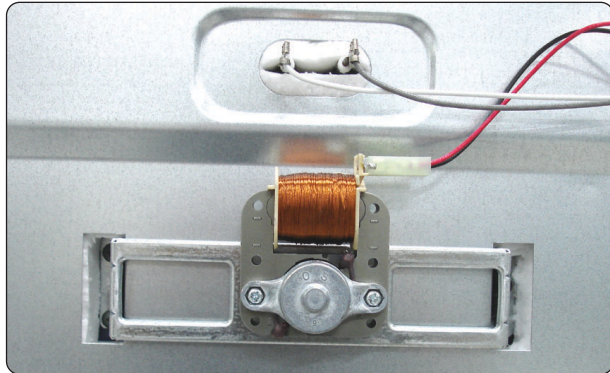

5. Remove the four Fan cover screws and set the fan cover aside.



6. Remove the two convection element screws and pull the element forward.

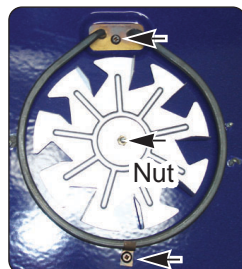

7. To remove Fan blade, remove Nut by screwing clockwise. Fan blade can be replaced from inside oven.

### CAUTION

- **Be careful not to bend the fan blade**  
- Failure to do so can result in vibration, noise, and poor performance of convection when operating.

8. To remove Fan motor assembly, disconnect wire connection and remove the three bracket screws
9. Pull the fan motor assembly forward.

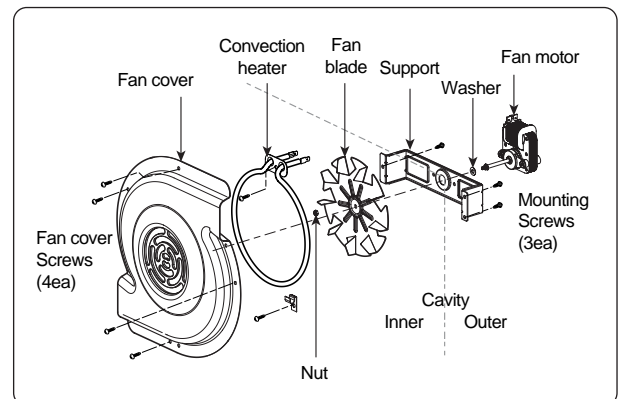
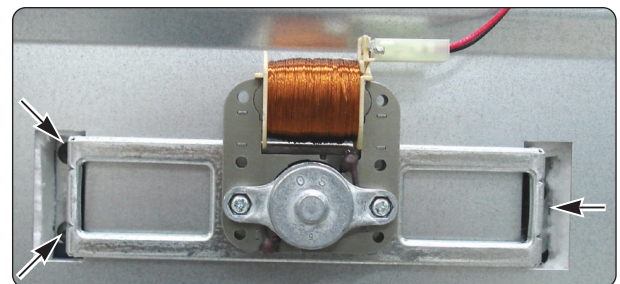

# COMPONENT ACCESS

## REMOVING THE OVEN LIGHT & SOCKET ASSEMBLY

### ⚠ WARNING

- **DISCONNECT** power supply cord from the outlet before servicing.
- **Replace all panels and parts before operating.**
- **RECONNECT** all grounding devices.
  - Failure to do so can result in severe personal injury, death or electrical shock.

### ⚠ CAUTION

- **Be careful when you work on the electric range handling the sheet metal part.**
  - Sharp edge may be present and you can cut yourself.

#### To replace:

1. Unplug range or disconnect power.
2. Turn the glass bulb cover in the back of the oven counterclockwise to remove.
3. Turn bulb counterclockwise to remove from socket.
4. Replace bulb and bulb cover by turning clockwise.

Glass cover & Bulb

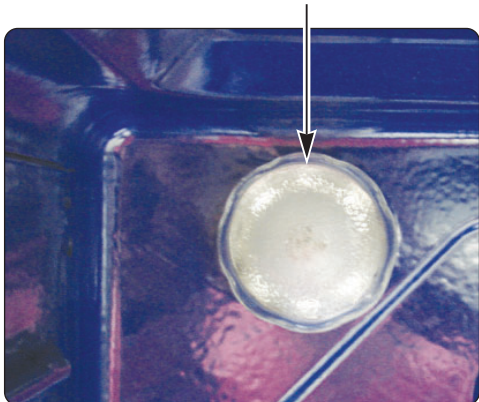

### ⚠ CAUTION

- **Be careful not to scratch or chip the oven liner paint when you remove the oven light socket in the next step.**

5. Use a screwdriver and bend the clips on the oven light socket away from the edges of the liner hole, and pull the socket out of the liner.

NOTE: If it is too difficult to remove the socket from the front of the oven, you will have to push the socket out from the back of the unit.

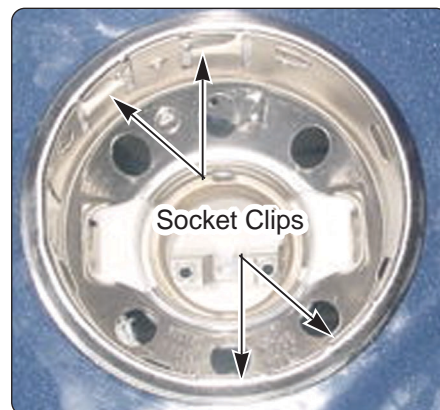

5. Disconnect the wires from the socket terminals.

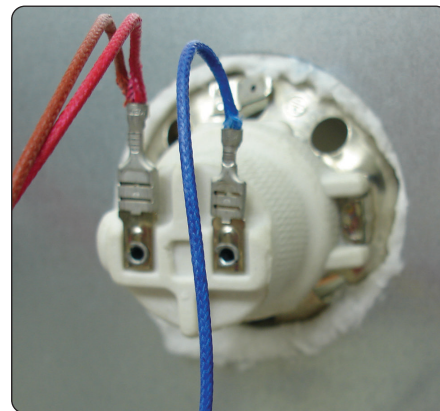

<Viewed From Rear Panel>

# COMPONENT ACCESS

## REMOVING THE LATCH DRIVE ASSEMBLY

### ⚠ WARNING

- **DISCONNECT** power supply cord from the outlet before servicing.
- **Replace all panels and parts before operating.**
- **RECONNECT** all grounding devices.
  - Failure to do so can result in severe personal injury, death or electrical shock.

### ⚠ CAUTION

- **Be careful when you work on the electric range handling the sheet metal part.**
  - Sharp edge may be present and you can cut yourself.

1. Turn off the electrical supply going to the range.
2. Pull the range away from the wall so that you can access the rear panel.
3. Remove the back cover & control cover (see step 3~4 on page 3-2).
4. Disconnect the wires from the latch drive motor and switch.
5. Remove the two mounting screws from the latch drive.

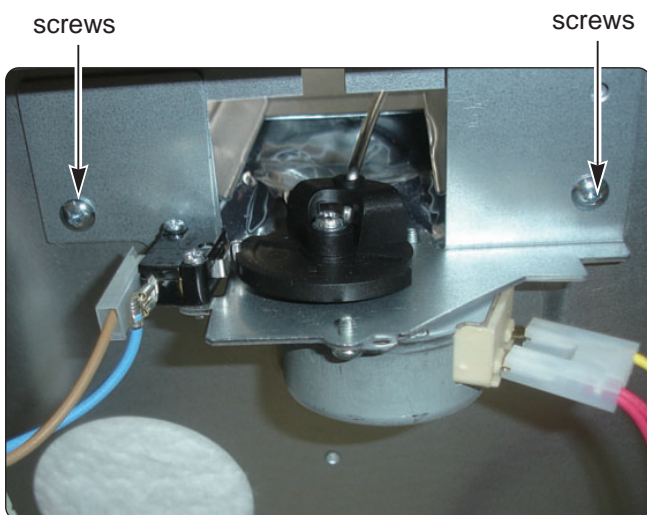

6. Unhook the Latch rod from the cam.

### DOOR LOCKING MECHANISM

The door lock assembly is located at the back side of range.

The structural elements are as below.

1. When the oven control is programmed and started for the Self clean and Lock out mode, PCB (Power control board) chip operates the motor.

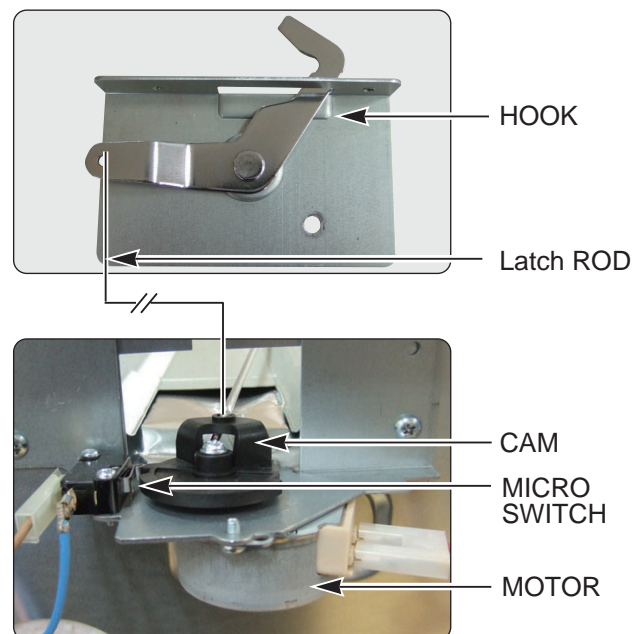

2. The cam moves the door hook connected to latch rod from unlocked position to locked position (from locked Position to unlocked position)
3. The cam activates the micro switch that causes the motor to stop.
4. The locked status remains until the range temperature drops to approximately 500F after end of the self clean or lock out feature is reactivated. The motor operates to unlock door at that time.



# COMPONENT ACCESS

## REMOVING THE OVEN TEMPERATURE SENSORS

### **⚠ WARNING**

- **DISCONNECT** power supply cord from the outlet before servicing.
- Replace all panels and parts before operating.
- **RECONNECT** all grounding devices.
  - Failure to do so can result in severe personal injury, death or electrical shock.

### **⚠ CAUTION**

- Be careful when you work on the electric range handling the sheet metal part.
  - Sharp edge may be present and you can cut yourself.

1. Turn off the electrical supply going to the range.
2. Open the oven door and remove the racks from the oven.
3. Pull the range away from the wall so that you can access the rear panel.
4. Remove the 16 screws from the rear panel and remove the panel (see step 3 on page 3-2).

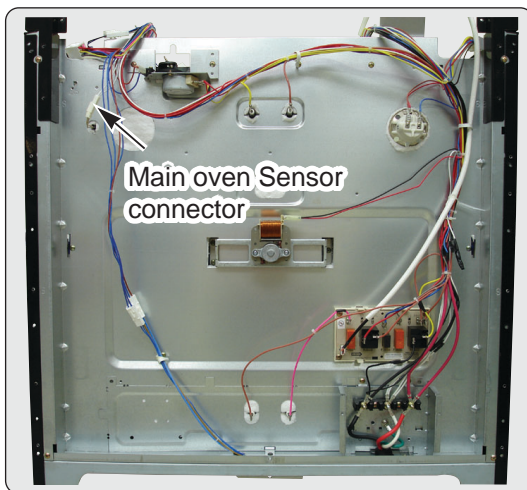

5. To remove an oven temperature sensor, disconnect the connector from the main harness and remove the two mounting screws in oven cavity.

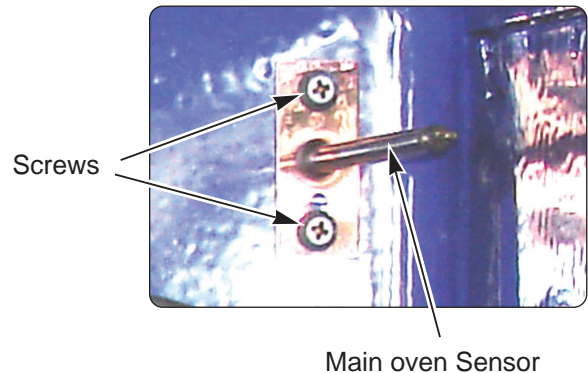

# COMPONENT ACCESS

## REMOVING THE WARMING DRAWER ELEMENT & TEMPERATURE SENSOR

### **⚠ WARNING**

- **DISCONNECT** power supply cord from the outlet before servicing.
- **Replace all panels and parts before operating.**
- **RECONNECT** all grounding devices.
  - Failure to do so can result in severe personal injury, death or electrical shock.

### **⚠ CAUTION**

- **Be careful when you work on the electric range handling the sheet metal part.**
  - Sharp edge may be present and you can cut yourself.

#### To Remove Warming Drawer:

### **⚠ CAUTION**

- **Turn power OFF** before removing the Warming Drawer.

1. Open the drawer to the fully opened position.
2. Remove the 2 screws (right and left side). (refer to below picture)

3. Locate glide lever on each side of drawer, push down on the left glide lever and pull up on the right glide lever.

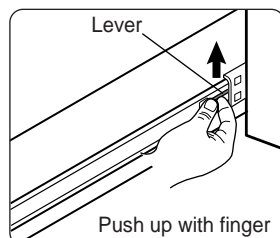
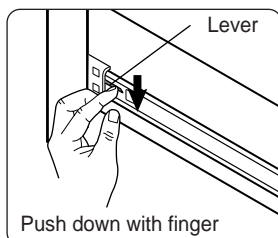
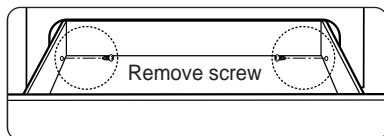

4. Pull the warming drawer away from the range.

#### To remove the warming drawer element:

1. Remove the two bottom bracket screws

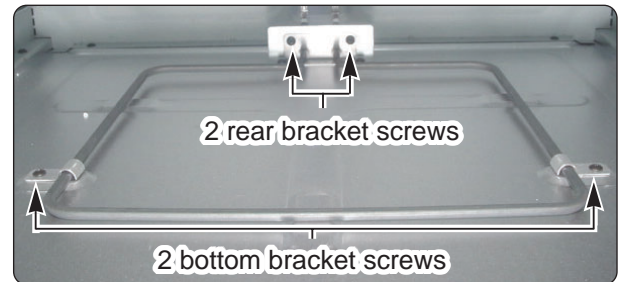

2. Remove the two rear bracket screws, and disconnect the wires from the terminals.

#### To remove the warming drawer temperature sensor:

1. Unplug the cord or disconnect power.
2. Pull the range away from the wall so that you can access the back cover.
3. Remove the back cover.
4. Remove the sensor cover screw and remove sensor cover.

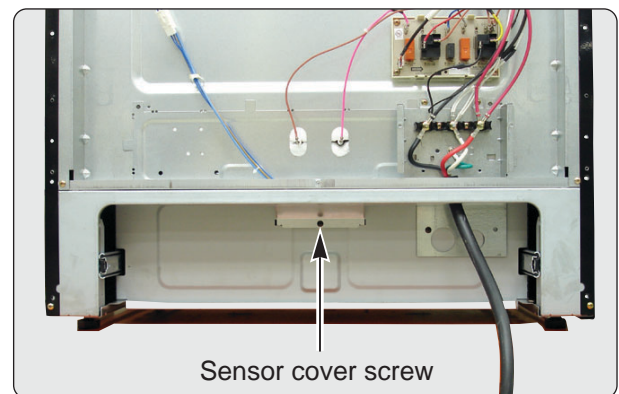

5. Remove the rear bracket screws (2ea).

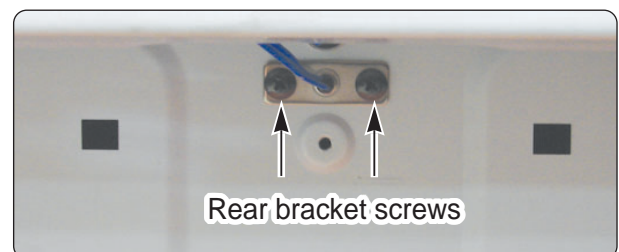

6. Pull the sensor forward and unplug the connectors.

# COMPONENT ACCESS

## REMOVING & REPLACING THE LIFT-OFF OVEN DOOR

### **CAUTION**

- Be careful when removing and lifting the door.
- DO NOT lift the door by the handle.
  - Failure to do so can result in personal injury as the door is very heavy.

### To remove the door:

#### Step. 1

Fully open the door.

#### Step. 2

Pull the hinge locks down toward (Fig.1) the door frame, to the unlocked position.

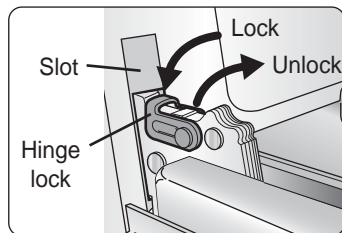

<Fig.1>

#### Step. 3

Firmly grasp both sides of the door at the top.

#### Step. 4

Close door to the door removal position, which is approximately 5 degrees. (refer to the Fig.2)

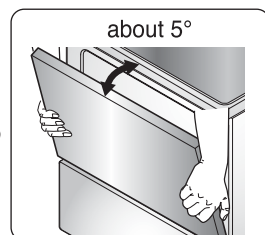

<Fig.2>

#### Step. 5

Lift door up and out until the hinge arm is clear of the slot.

### To replace the door:

#### Step. 1

Firmly grasp both sides of the door at the top.

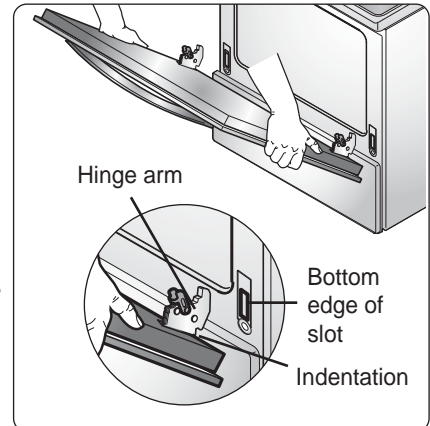

#### Step. 2

With the door at the same angle as the removal position, seat the indentation of the hinge arm into the bottom edge of the hinge slot. The notch in the hinge arm must be fully seated into the bottom of the slot.

#### Step. 3

Fully open the door. If the door will not fully open, the indentation is not seated correctly in the bottom edge of the slot.

#### Step. 4

Push the hinge locks up against the front frame of the oven cavity to the locked position.

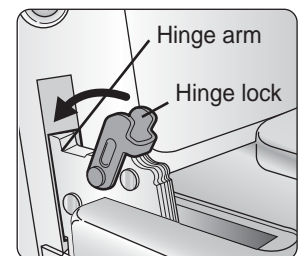

#### Step. 5

Close the oven door.

# COMPONENT ACCESS

## REMOVING THE OVEN DOOR HANDLE & GLASS

### **⚠ WARNING**

- **DISCONNECT** power supply cord from the outlet before servicing.
- Replace all panels and parts before operating.
- **RECONNECT** all grounding devices.
  - Failure to do so can result in severe personal injury, death or electrical shock.

### **⚠ CAUTION**

- Be careful when you work on the electric range handling the sheet metal part.
  - Sharp edge may be present and you can cut yourself.

1. Remove the oven door from the range (see page 3-13 for the procedure).
2. Place the oven door on a padded work surface with the front glass facing down.
3. Remove the 4 top door screws.



4. Remove the three bottom screws from the door liner.

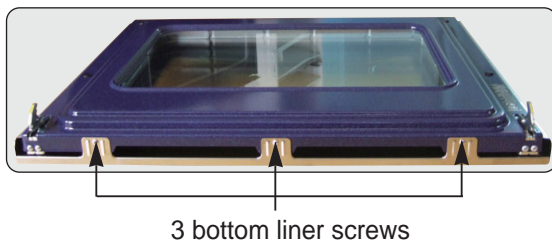

5. Lift the liner assembly off the front glass and set it aside.
6. To remove the door handle & trim (for stainless model)
  - a) Remove the 4 door handle screws and lift the door handle off door trim and slide up the door handle.

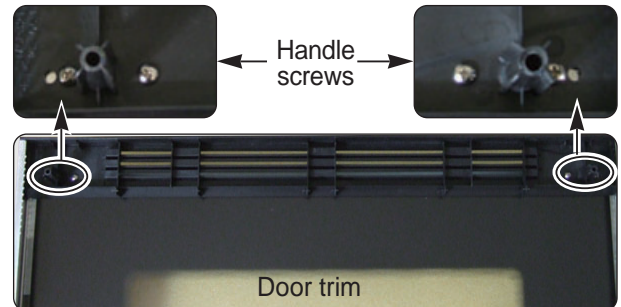

# COMPONENT ACCESS

## 7. To remove a hinge hanger assembly:

- Remove the 2 top liner screws  
(See step 3 on page 3-14)
- Place the door liner assembly on a padded work surface with the hinge hangers over the edge.
- Remove the two bottom screws.
- Lift the hinge hanger out of the door liner slot.



- Lift the inner oven door glass and bracket assembly out of the door liner.



REASSEMBLY NOTE: When you reinstall the insulation around the oven door glass, make sure that the insulation is not visible in the glass after the door is reassembled.

## 8. To remove the oven door glass assembly:

- Remove both hinge hangers (see step 8).
- Remove the 6 screws.
- Lift the insulation cover off the door liner.

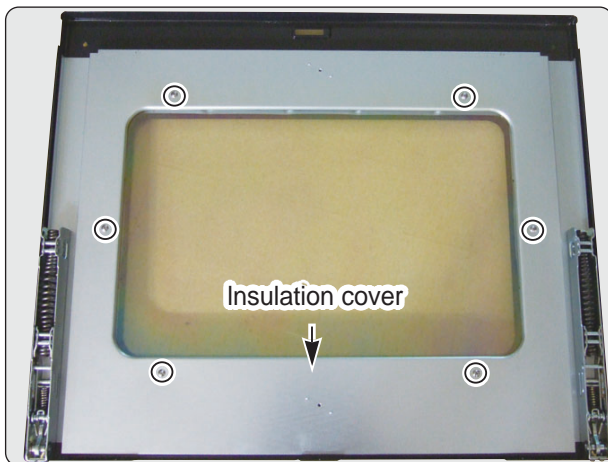

# COMPONENT ACCESS

## REMOVING THE OVEN DOOR GASKET

### **⚠ WARNING**

- **DISCONNECT** power supply cord from the outlet before servicing.
- **Replace all panels and parts before operating.**
- **RECONNECT** all grounding devices.
  - Failure to do so can result in severe personal injury, death or electrical shock.

### **⚠ CAUTION**

- **Be careful when you work on the electric range handling the sheet metal part.**
  - Sharp edge may be present and you can cut yourself.

1. Open the oven door to its fully down position.
2. Pull the oven door gasket clips out of the liner holes until all of the clips are removed.

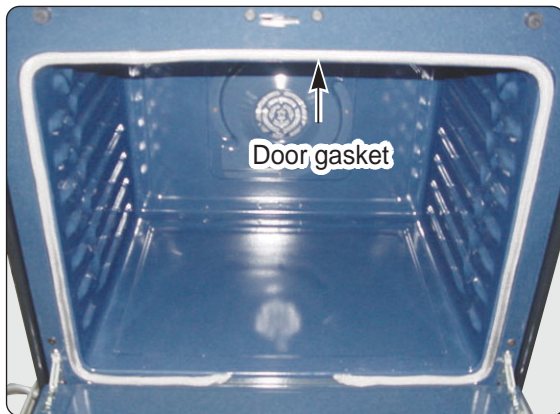

3. Pull the ends of the gasket out of the liner holes.

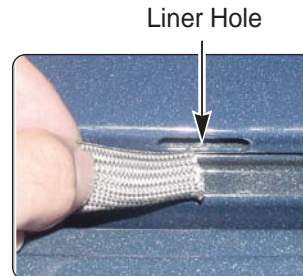

**REASSEMBLY NOTE:** When you install the new gasket, make sure that all of the clips are seated in their liner holes, and that the ends of the gasket are pushed fully into their holes. Use the pointed end of a pencil to push the gasket ends into the holes.

# COMPONENT ACCESS

## REMOVING A SIDE PANEL

### **⚠ WARNING**

- **DISCONNECT** power supply cord from the outlet before servicing.
- **Replace all panels and parts before operating.**
- **RECONNECT** all grounding devices.
  - Failure to do so can result in severe personal injury, death or electrical shock.

### **⚠ CAUTION**

- **Be careful when you work on the electric range handling the sheet metal part.**
  - Sharp edge may be present and you can cut yourself.

1. Turn off the electrical supply going to the range.
2. Remove the oven door from the range (see page 3-13 for the procedure).
3. Pull the range away from the wall so you can access the back of the unit.
4. Remove the 16 screws from the rear panel and remove the panel (see step 3~4 on page 3-2).
5. Raise the cooktop (see page 3-4 for the procedure). **NOTE:** Position the side of the cooktop so that it does not rest on the side panel that you are removing.
6. Remove the two screws from the top rear of the side panel.



7. Remove the two screws from the left or right side panel.

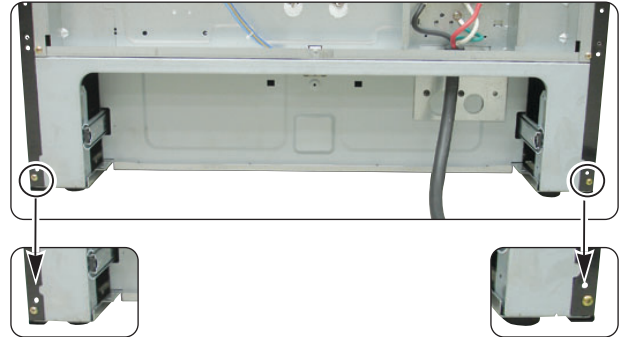

8. Pull the back of the side panel out from the range approximately 10°.

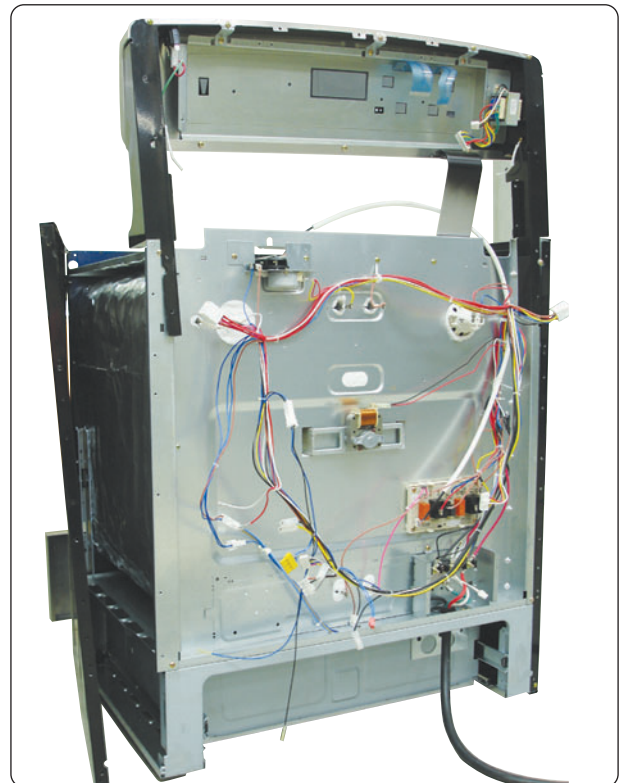

9. Push forward and remove the side panel.

# COMPONENT TEST

Before testing any of components, perform the following checks:

**NOTE:**

1. The most common cause for control failure is corrosion on connectors.  
Therefore, disconnecting and reconnecting wires will be necessary throughout test procedures
2. ALL units in the first few days of use should be checked for mis-wiring or loose connections

1. All/tests/checks should be made with a VOM or DVM having a sensitivity of 20,000 ohms per-volt DC, or greater.
2. Check all connections before replacing components, looking for broken or loose wires, Failed terminals, or wires not pressed into connectors far enough.
3. Resistance checks must be made with power cord unplugged from outlet, and with wiring harness or connectors disconnected.



**⚠ WARNING**

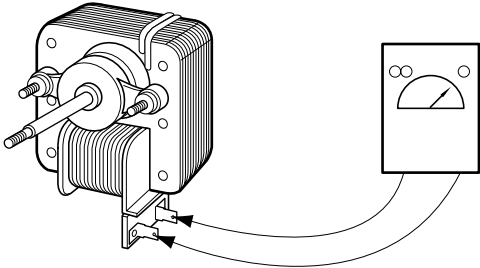

- Disconnect power supply cord from the outlet before servicing
- Replace all panels and parts before operating
- Reconnect all grounding devices after servicing
- Failure to do so can result in death or electrical shock

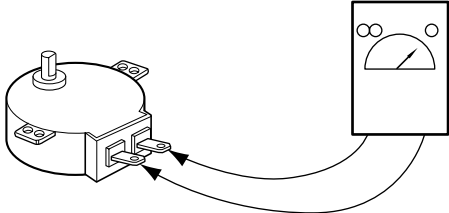
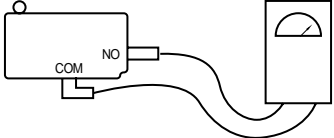

**NOTE:** Below  $\Omega$  value were tested at room temperature (77F/25°C)

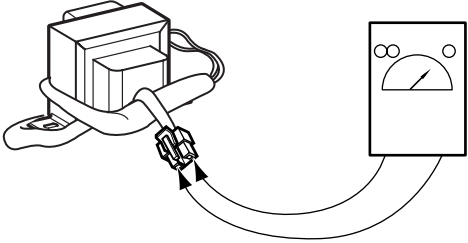
Components	Test procedures	Results
<p>Convection Motor</p>	<ol style="list-style-type: none"> <li>1. Refer to page 3-8 for the servicing procedure</li> <li>2. Measure the resistance (Multiple meter scale: R x 1)</li> </ol> 	<p>Normal: Approximately 33.5 <math>\Omega</math> <math>\pm</math> 10% If not replace</p> <p>Abnormal: Infinite (open) below 5<math>\Omega</math> (shorted)</p>

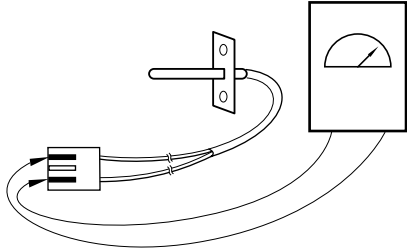
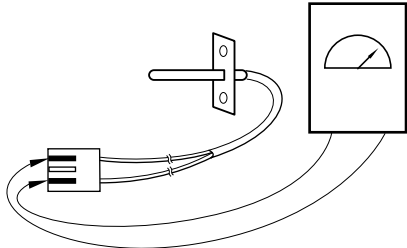
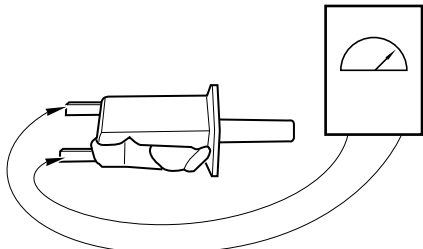

Components	Test procedures	Results	
Door locking Motor	1. Refer to page 3-10 for the servicing procedure 2. Measure the resistance (Multiple meter scale: R x 1000)  	Normal: Approximately $2.6\text{ k}\Omega \pm 10\%$ If not replace Abnormal: Infinite(open) below $5\Omega$ (shorted)	
Micro Switch (normally open type)	1. Refer to page 3-10 for the servicing procedure 2. Measure the resistance (Multiple meter scale: R x 1000)  	Door latch open	Door latch Locked
		 Continuity	 Infinite
NOTE: After checking for the continuity of switch, make sure that they are connected correctly			
LVT	1. Refer to page 3-3 for the servicing procedure 2. Measure the resistance (Multiple meter scale: R x 1000)  	Normal: Approximately $27\ \Omega \pm 10\%$ If not replace	

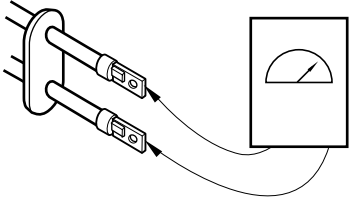
Components	Test procedures	Results	
Oven Sensor	1. Refer to page 3-11 for the servicing procedure 2. Measure the resistance after cooling down (Multiple meter scale: R x 1000) 	Normal: Approximately $1.09 \text{ k}\Omega \pm 10\%$ If not replace  <b>NOTE:</b> $\Omega$ Value was tested at room temperature (77F/25°C)	
<p style="text-align: center;">NOTE: Oven sensor is so sensitive to temperature Do test after cooling down sufficiently</p>			
Warming Drawer Sensor	1. Refer to page 3-12 for the servicing procedure 2. Measure the resistance after cooling down (Multiple meter scale: R x 1000) 	Normal: Approximately $4.6 \text{ k}\Omega \pm 10\%$ If not replace  <b>NOTE:</b> $\Omega$ Value was tested at room temperature (77F/25°C)	
<p style="text-align: center;">NOTE: Oven sensor is so sensitive to temperature Do test after cooling down sufficiently</p>			
Door switch	1. Refer to page 3-5 for the servicing procedure 2. Measure the resistance after cooling down (Multiple meter scale: R x 1000) 	Door open	Door closed
		 Continuity	 Infinite

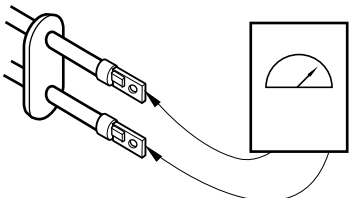
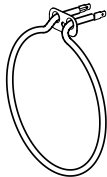
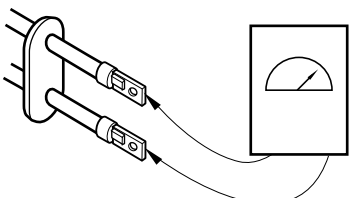
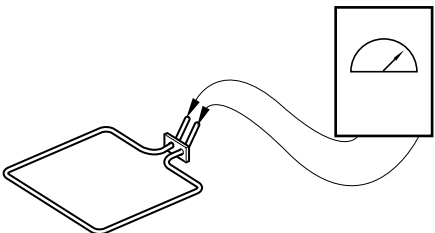
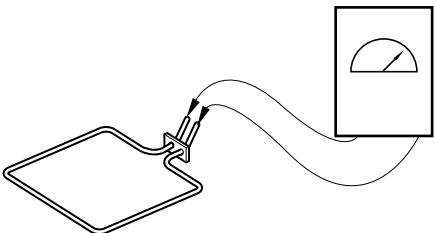
Components	Test procedures	Results
<p data-bbox="147 342 289 370">Broil heater</p> 	<ol data-bbox="480 342 1040 449" style="list-style-type: none"> <li>1. Refer to page 3-6 for the servicing procedure</li> <li>2. Measure the resistance after cooling down (Multiple meter scale: R x1)</li> </ol> 	<p data-bbox="1141 342 1386 434">Normal: Approximately 14 <math>\Omega</math> <math>\pm</math> 10% If not replace</p> <div data-bbox="1141 485 1474 655" style="background-color: #e0e0e0; padding: 5px;"> <p><b>NOTE:</b> <math>\Omega</math> Value was tested at room temperature (77F/25°C) Be careful the element is so sensitive to temperature.</p> </div>
<p data-bbox="147 751 295 778">Bake heater</p> 	<ol data-bbox="480 751 1040 857" style="list-style-type: none"> <li>1. Refer to page 3-7 for the servicing procedure</li> <li>2. Measure the resistance after cooling down (Multiple meter scale: R x1)</li> </ol> 	<p data-bbox="1141 751 1386 842">Normal: Approximately 17 <math>\Omega</math> <math>\pm</math> 10% If not replace</p> <div data-bbox="1141 893 1474 1064" style="background-color: #e0e0e0; padding: 5px;"> <p><b>NOTE:</b> <math>\Omega</math> Value was tested at room temperature (77F/25°C) Be careful the element is so sensitive to temperature.</p> </div>
<p data-bbox="147 1159 367 1187">Convection heater</p> 	<ol data-bbox="480 1159 1040 1266" style="list-style-type: none"> <li>1. Refer to page 3-8 for the servicing procedure</li> <li>2. Measure the resistance after cooling down (Multiple meter scale: R x1)</li> </ol> 	<p data-bbox="1141 1159 1386 1251">Normal: Approximately 17 <math>\Omega</math> <math>\pm</math> 10% If not replace</p> <div data-bbox="1141 1308 1474 1478" style="background-color: #e0e0e0; padding: 5px;"> <p><b>NOTE:</b> <math>\Omega</math> Value was tested at room temperature (77F/25°C) Be careful the element is so sensitive to temperature.</p> </div>
<p data-bbox="147 1568 435 1596">Warming Drawer heater</p> 	<ol data-bbox="480 1568 1053 1674" style="list-style-type: none"> <li>1. Refer to page 3-12 for the servicing procedure</li> <li>2. Measure the resistance after cooling down (Multiple meter scale: R x1)</li> </ol> 	<p data-bbox="1141 1568 1386 1659">Normal: Approximately 95 <math>\Omega</math> <math>\pm</math> 10% If not replace</p> <div data-bbox="1141 1723 1474 1893" style="background-color: #e0e0e0; padding: 5px;"> <p><b>NOTE:</b> <math>\Omega</math> Value was tested at room temperature (77F/25°C) Be careful the element is so sensitive to temperature.</p> </div>

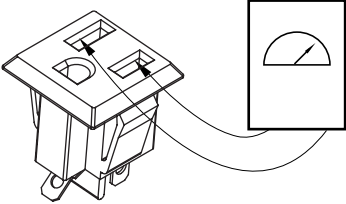
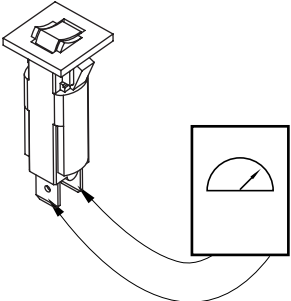
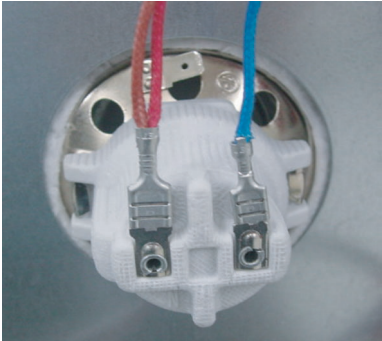
Components	Test procedures	Results
Appliance outlet	<p>1. Test for voltage</p>  <p>2. If no voltage is present at outlet, Press the switch of located on the control console</p> <p><b>NOTE:</b> The circuit breaker for the appliance outlet is rated for 15A, That may trip if the appliance plugged into it exceeds 15amps. To reset the circuit breaker, press the circuit breaker switch.</p>	Normal: Approximately 120V
Appliance outlet circuit breaker	<p>1. If no voltage is present at outlet,  1) Unplug the cord or disconnect power  2) Remove the back cover (refer to the page 3-2)  3) Test the circuit breaker resistance</p> 	Normal: Below 1 Ω. If not replace
Oven lamp	<p>1. Measure the resistance after cooling down (Multiple meter scale: R x1)</p> 	Normal: Below 5 Ω. If not replace

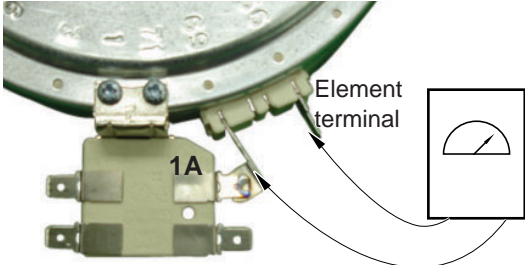
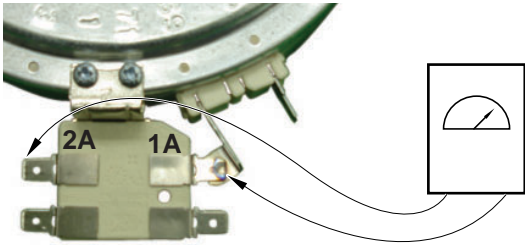
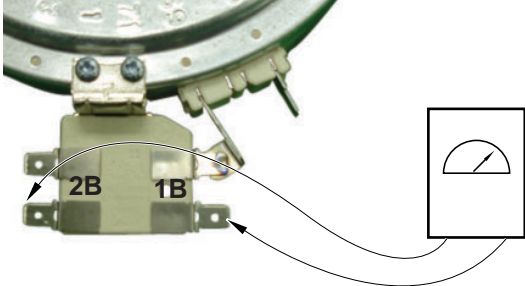
Components	Test procedures	Results
<p><b>Single surface units:</b>            Left Front (LF),            Left Rear (LR)            and            Right Rear(RR)            Element</p>	<p>1. Refer to page 3-4 for the servicing procedure</p> <p>2. Set the Multiple meter scale to the R x 1</p> <p>3. Disconnect wires from cook-top elements</p> <p>4. Touch the ohmmeter test leads to the element terminal and 1A.            The meter should indicate <math>46 \Omega \pm 10\%</math></p>  <p>5. Touch the ohmmeter test leads to limiter terminals 1A and 2A. The meter should continuity(<math>0\Omega</math>)</p>  <p>6. Touch the ohmmeter test leads to limiter terminals 1B and 2B.            With the temperature below <math>150^{\circ}\text{F}</math>, the meter should indicate an open circuit(infinite).            With the temperature above <math>150^{\circ}\text{F}</math>, the meter should indicate continuity (<math>0\Omega</math>).</p> 	<p>Normal: Approximately <math>46 \Omega</math>,            If not replace</p> <p>Normal: continuity            (below <math>0.5 \Omega</math>)            If not replace</p> <p>Below <math>150^{\circ}\text{F}</math>            → open circuit(infinite).</p> <p>Above <math>150^{\circ}\text{F}</math>            → continuity (<math>0 \Omega</math>)</p>

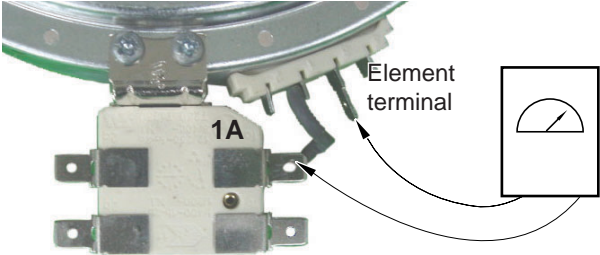
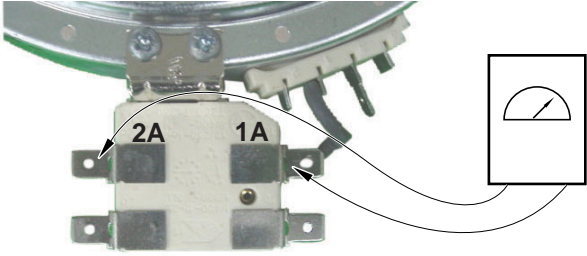
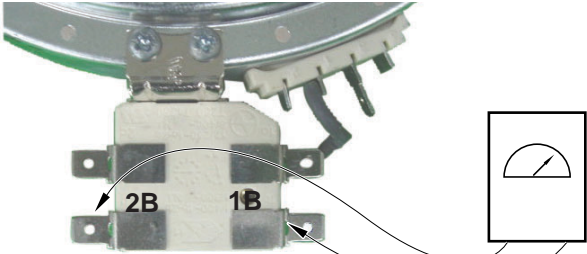
Components	Test procedures	Results
<p>Center Rear(CR) Element ;Warming Zone</p>	<p>1. Refer to page 3-4 for the servicing procedure  2. Set the Multiple meter scale to the R x 1  3. Disconnect wires from CR elements  4. Touch the ohmmeter test leads to the element terminal and 1A. The meter should indicate <math>565 \Omega \pm 10\%</math></p>  <p>5. Touch the ohmmeter test leads to limiter terminals 1A and 2A.the meter should indicate continuity (0 <math>\Omega</math>)</p>  <p>6. Touch the ohmmeter test leads to limiter terminals 1B and 2B.  With the temperature below 150°F, the meter should indicate an open circuit(infinite).  With the temperature above 150°F, the meter should indicate continuity (0 <math>\Omega</math>).</p> 	<p>Normal: Approximately 565 <math>\Omega</math>, If not replace</p> <p>Normal: continuity (below 0.5 <math>\Omega</math>) If not replace</p> <p>Below 150°F → open circuit(infinite).</p> <p>Above 150°F → continuity (0 <math>\Omega</math>)</p>

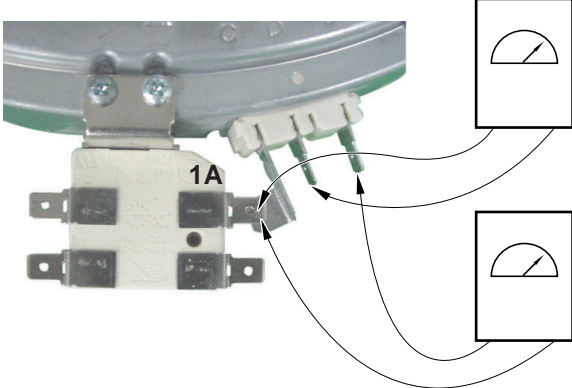
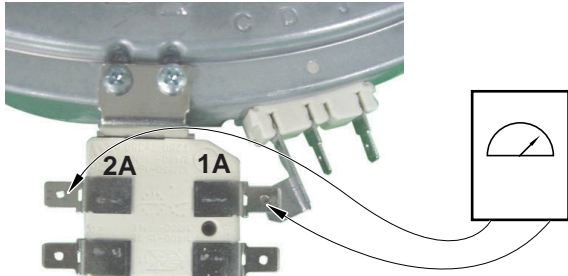
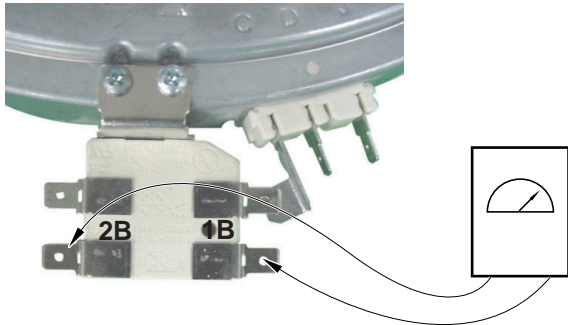
Components	Test procedures	Results
Dual surface element : Right Front(RF)	<ol style="list-style-type: none"> <li>1. Refer to page 3-4 for the servicing procedure</li> <li>2. Set the Multiple meter scale to the R x1</li> <li>3. Disconnect wires from cook-top elements</li> <li>4. Touch the ohmmeter test leads to the (E1 &amp; 1A) and (E2 &amp; 1A) the meter should indicate :           <ul style="list-style-type: none"> <li>- (E1 &amp; 1A) → 32 Ω ± 10%</li> <li>- (E1 &amp; 1A) → 55 Ω ± 10%</li> </ul>  </li> <li>5. Touch the ohmmeter test leads to limiter terminals 1A and 2A.the meter should indicate continuity (0 Ω)            </li> <li>6. Touch the ohmmeter test leads to limiter terminals 1B and 2B.           <p>With the temperature below 150°F, the meter should indicate an open circuit(infinite).</p> <p>With the temperature above 150°F, the meter should indicate continuity (0 Ω).</p>  </li> </ol>	<p>Normal: Approximately 32 Ω</p> <p>Normal: Approximately 55 Ω</p> <p>Normal: continuity (below 0.5 Ω) If not replace</p> <p>Below 150°F → open circuit(infinite).</p> <p>Above 150°F → continuity (0 Ω)</p>

# COMPOSITION OF CONTROL

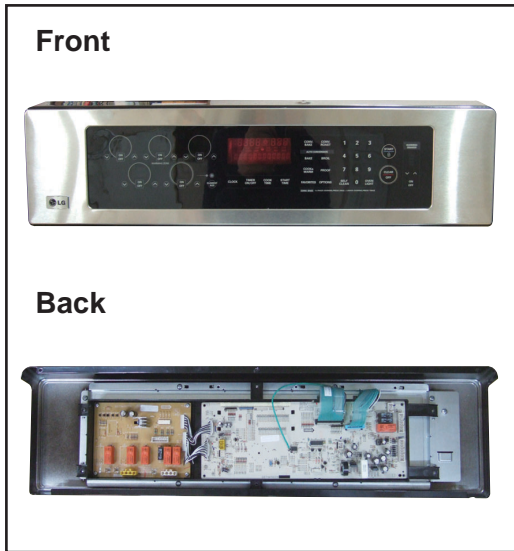

**Controller assembly**

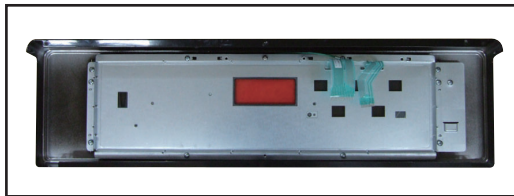

**Key pad assembly**

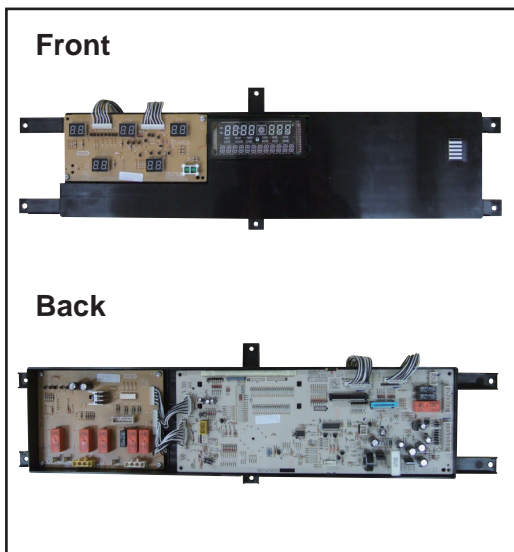

**PCB case assembly**

**Main PCB ( P/N : 6871W1N009F)**

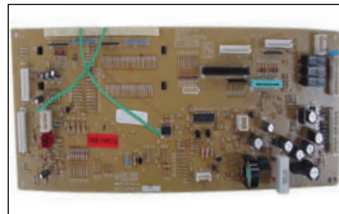

**Front**

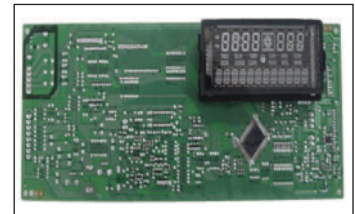

**Back**

**Cook top display PCB ( P/N : 6871W1N010E)**

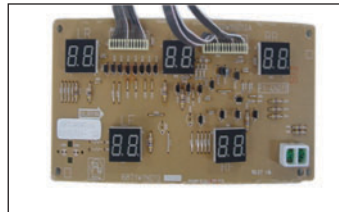

**Front**

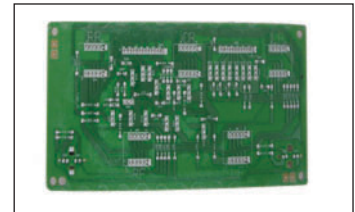

**Back**

**Cook top relay PCB ( P/N : 6871W1N011D)**

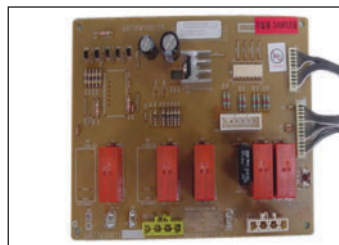

**Front**

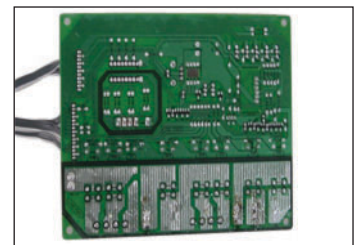

**Back**

**Oven relay PCB ( P/N : 6871W1N012A)**

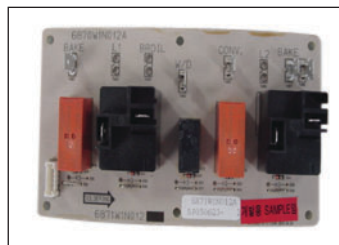

**Front**

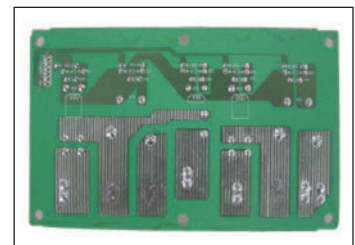

**Back**



# COMPOSITION OF CONTROL

## Main PCB

P/N :6871W1N009F

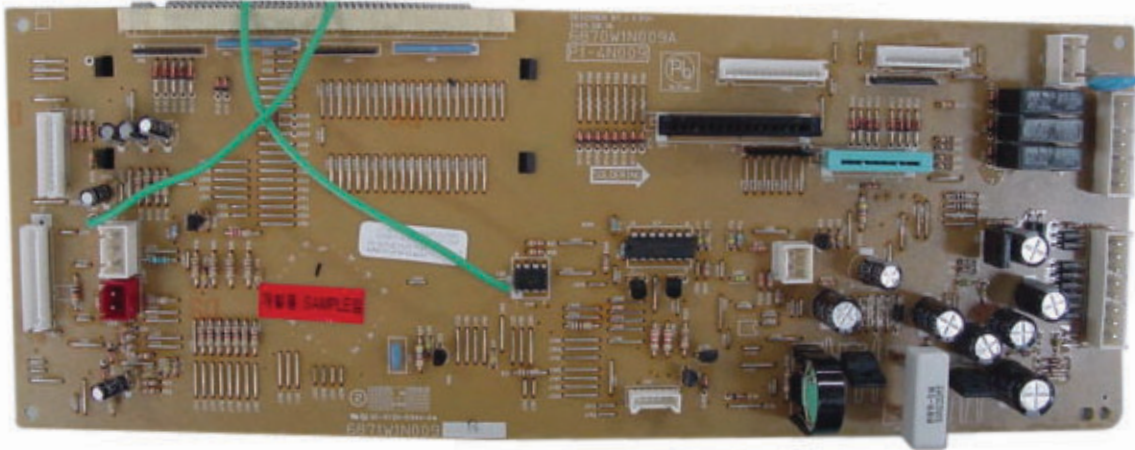

## Main function

- ▶ Supply a DC power source (GND, -5V, -12V(Vry(oven heater switching)), -30V)
- ▶ Oven heater control (DLB / Broil / Bake / Warming drawer / convection)
- ▶ Oven display control
- ▶ Warming drawer display control
- ▶ Cook top heater control (Warmer zone / RR / LR / RF / LF)
- ▶ Cook top display control
- ▶ Oven lamp / door lock motor / convection fan control
- ▶ Detecting oven temperature / warming drawer temperature
- ▶ Buzzer sound control
- ▶ Key entry
- ▶ Door open/close, Door lock/unlock detection
- ▶ Error mode detection and pop up
- ▶ Supervising hot cook top element

# COMPOSITION OF CONTROL

## Cook-top display PCB

P/N :6871W1N010E

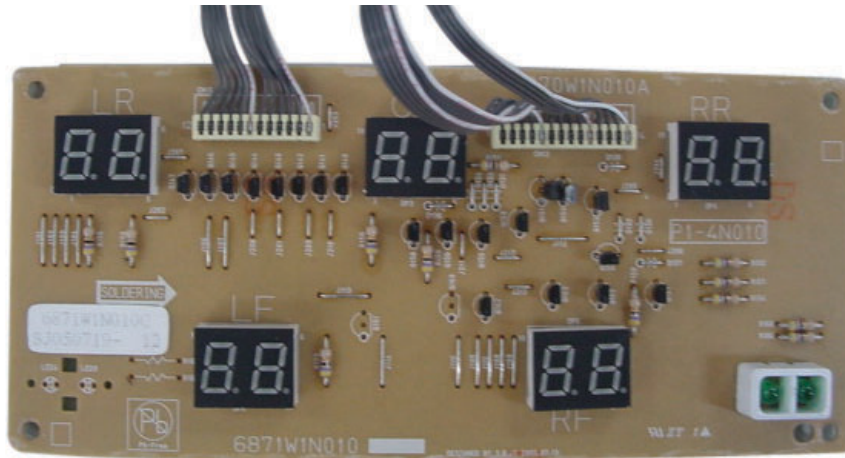

### Main function

- ▶ Single radiant surface elements -Right Rear, Left Rear, Left Front- power level indication
- ▶ Dual radiant surface elements -Right Front inner, outer- power level indication
- ▶ Dual radiant surface element size indication -Right Front inner, outer
- ▶ Single radiant surface elements -warming zone (Center Rear) - power level indication

# COMPOSITION OF CONTROL

## Cook-top relay PCB

P/N :6871W1N011D

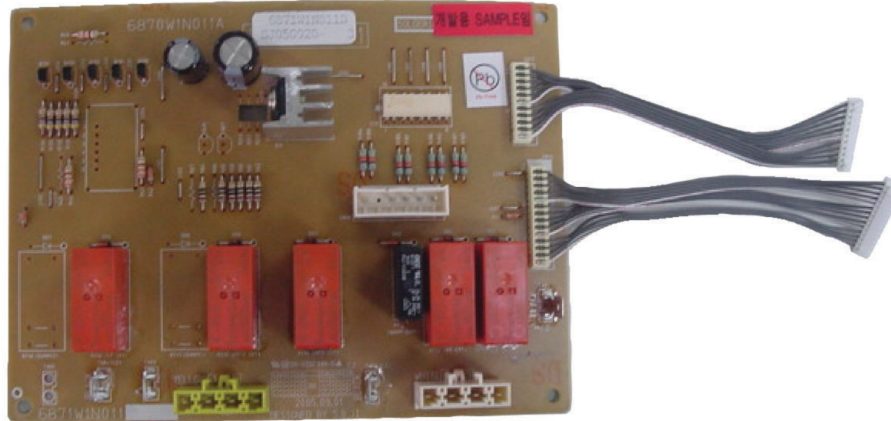

### Main function

- ▶ Supply a DC power source (GND, -12V (Vry(cooktop heater switching voltage))
- ▶ Single Radiant Surface Elements -Right Rear, Left Rear, Left Front - on/off, power level relay switching
- ▶ Dual Radiant Surface Elements -Right Front INNER, OUTER - on/off, power level relay switching
- ▶ Single Radiant Surface Elements  
- Warming Zone (Center Rear) -on/off, power level relay switching
- ▶ Supervising cook top element hot
- ▶ Warm drawer power level(5 level) indication

## Oven relay PCB

P/N :6871W1N012A

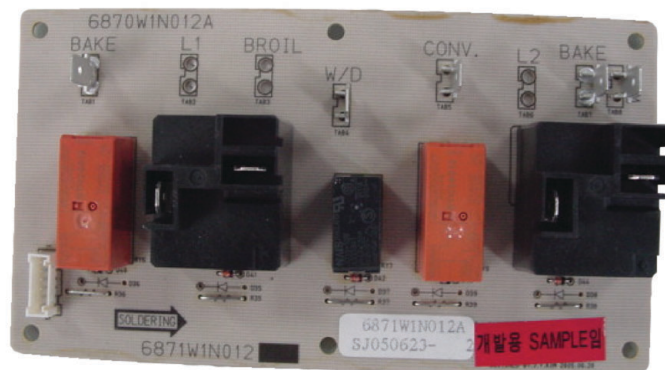

### Main function

- ▶ Oven heater on/off relay switching  
(DLB / Broil / Bake / Warming drawer / convection)

# CHECKING FLOW CHART BY FAILURE MODE

## No display (No power)

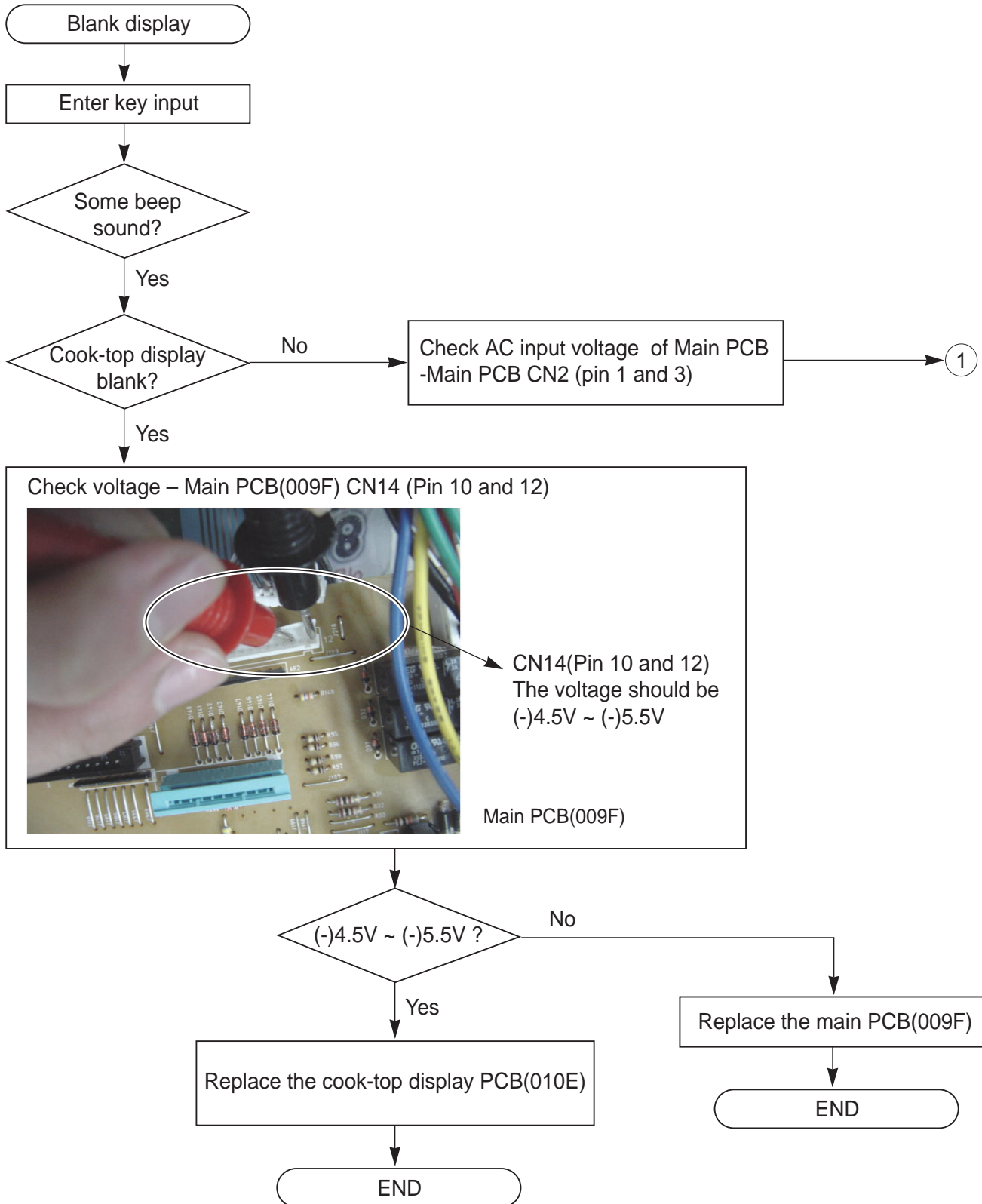

# CHECKING FLOW CHART BY FAILURE MODE

## No display (No power)

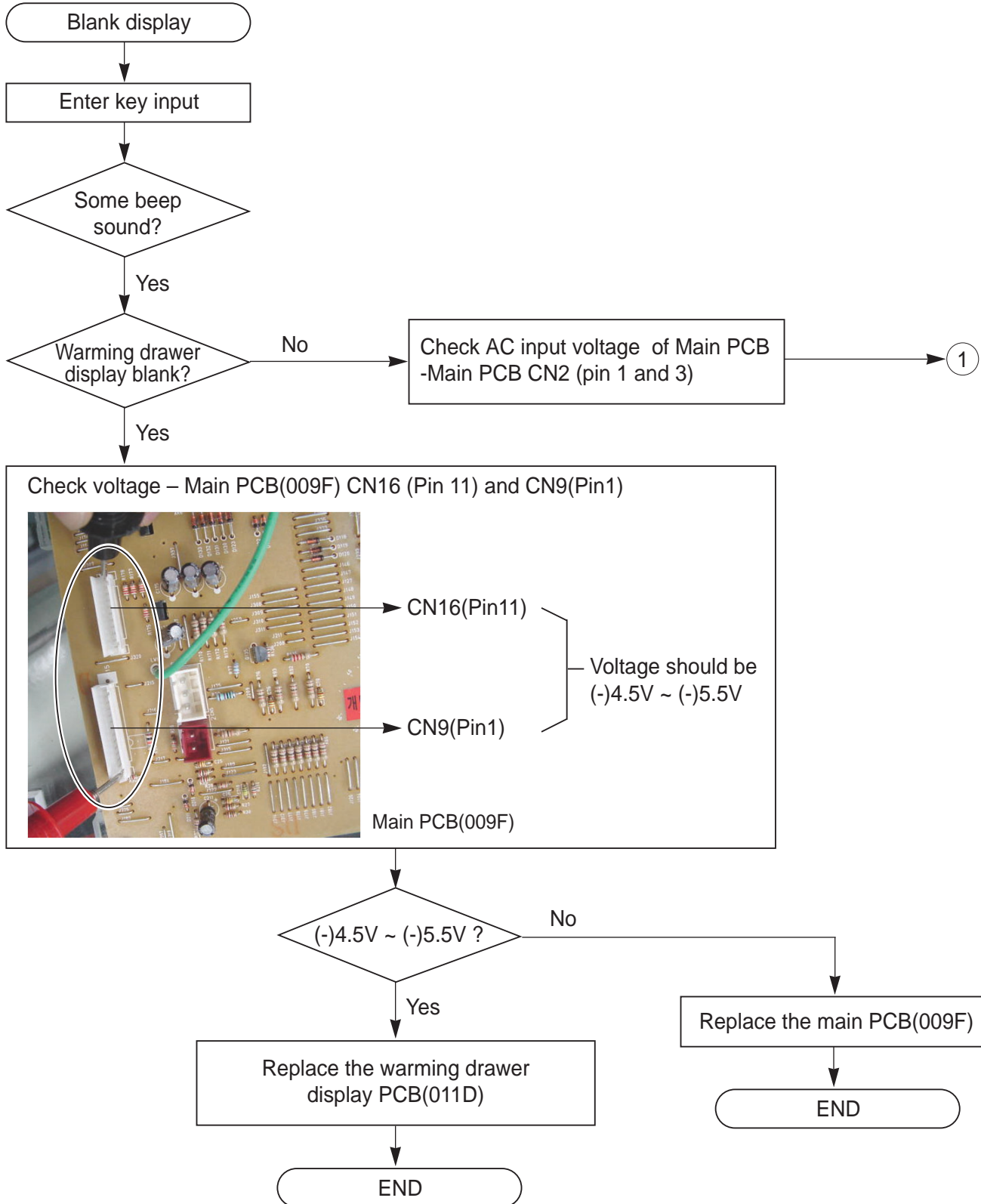

# CHECKING FLOW CHART BY FAILURE MODE

## No display (No power)

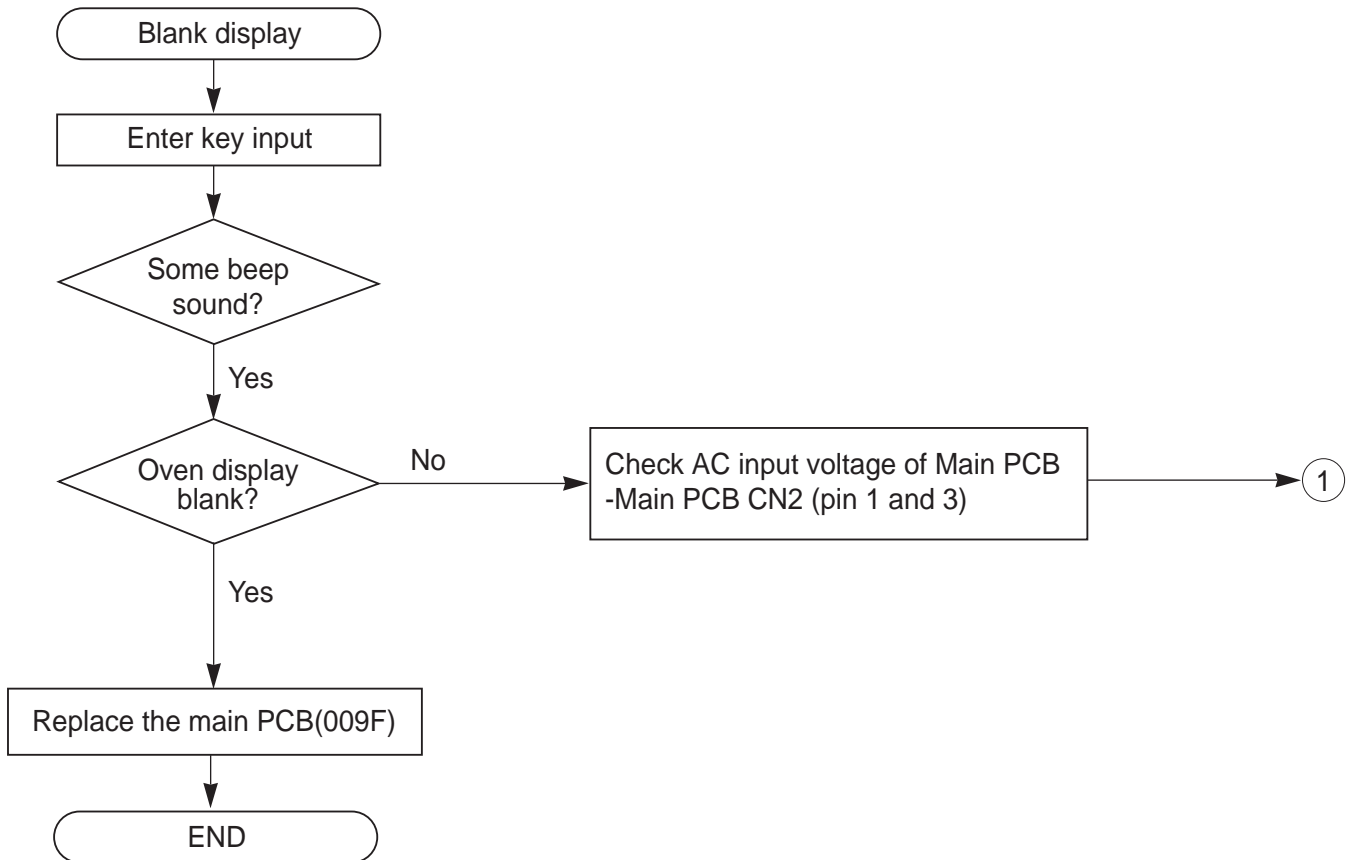

# CHECKING FLOW CHART BY FAILURE MODE

## No display (No power)

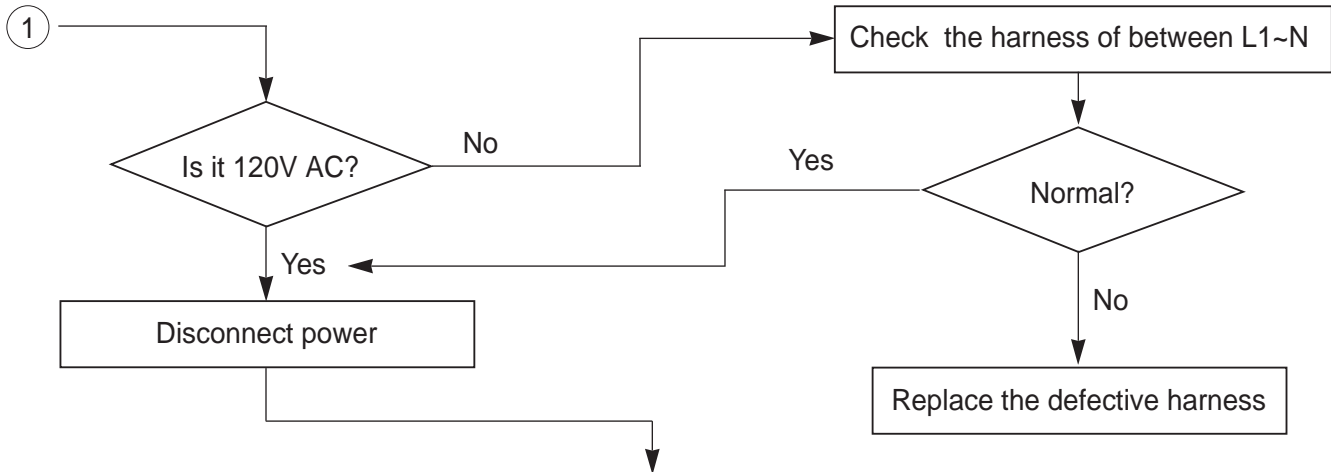

Check the power transformer (Refer to the below)

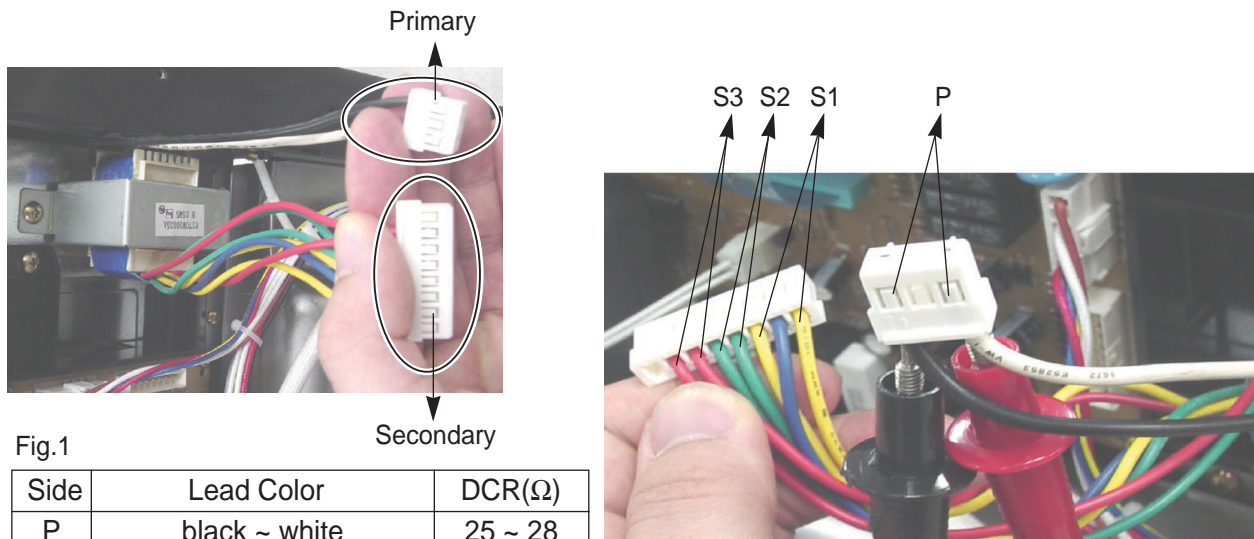
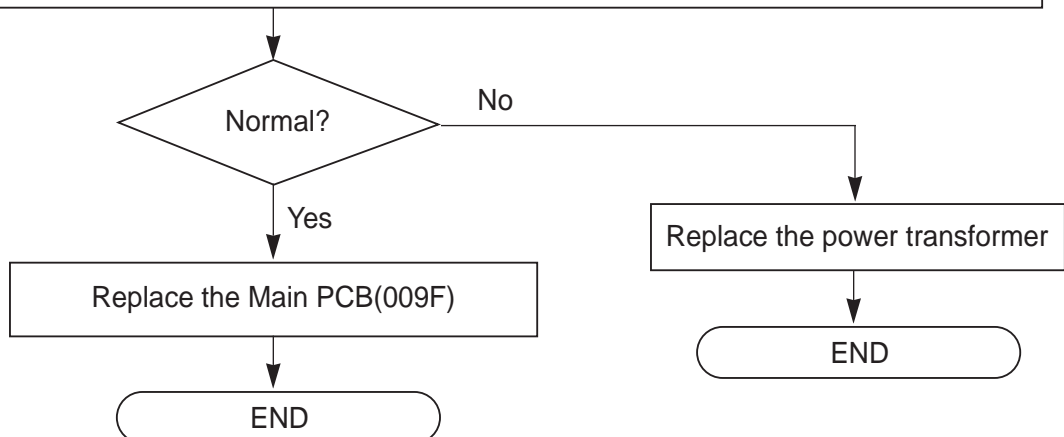

Fig.1

Side	Lead Color	DCR( $\Omega$ )
P	black ~ white	25 ~ 28
S1	yellow ~ blue ~ yellow	4.2 ~ 4.9
S2	green ~ green	1.5 ~ 1.8
S3	red ~ red	1.1 ~ 1.3

measure LVT coil resistance  
(Normal: approximately Fig.1)



# CHECKING FLOW CHART BY FAILURE MODE

## Oven does not heat

Code	Error mode	Operation	Times/sampling
F-7	No heating	If current oven temperature does not exceed 150°F and less equal than start temperature over 5 minutes on preheating, where door is closed. (except proof and cook & warm )	During cook

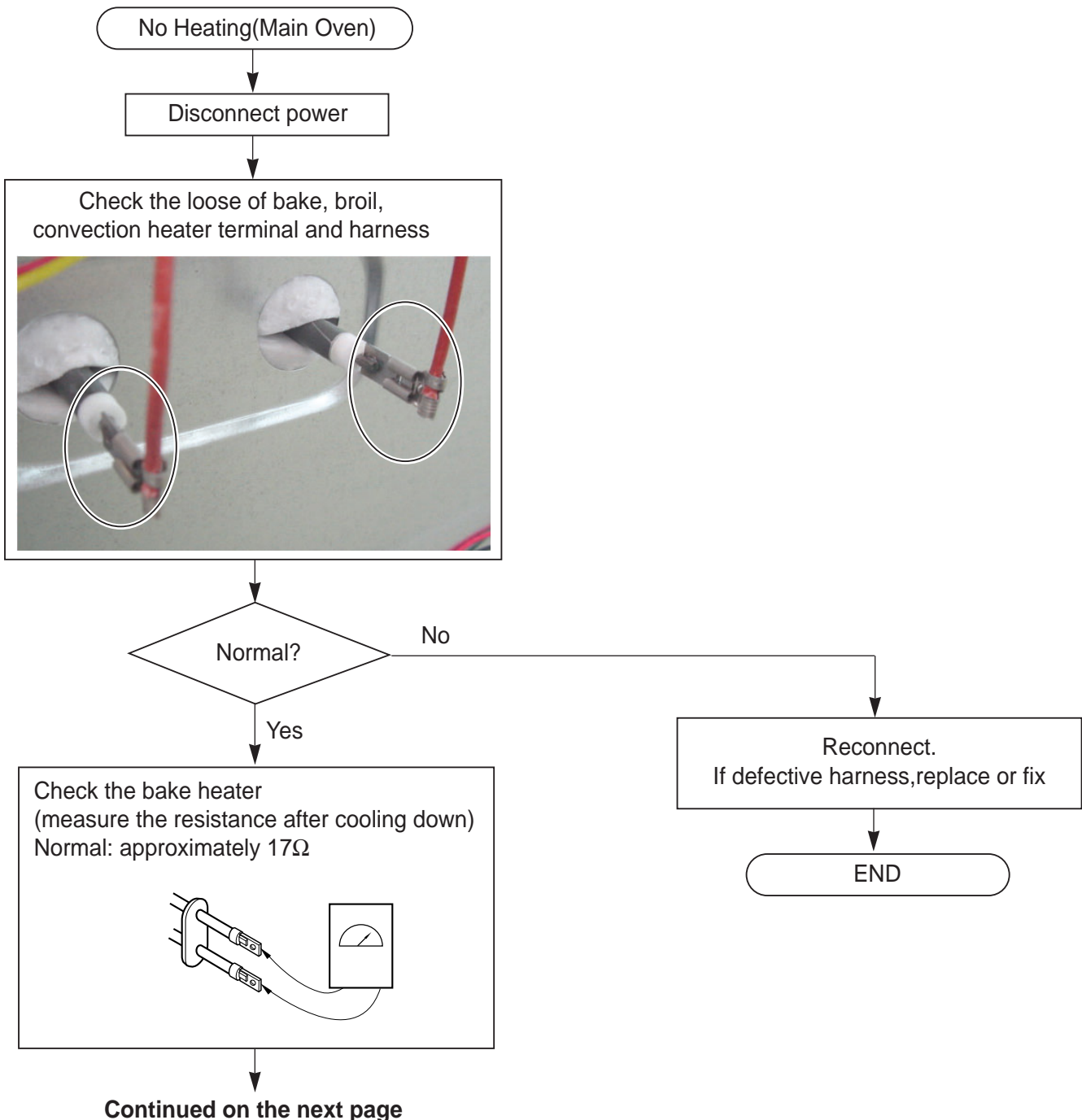



# CHECKING FLOW CHART BY FAILURE MODE

Oven does not heat

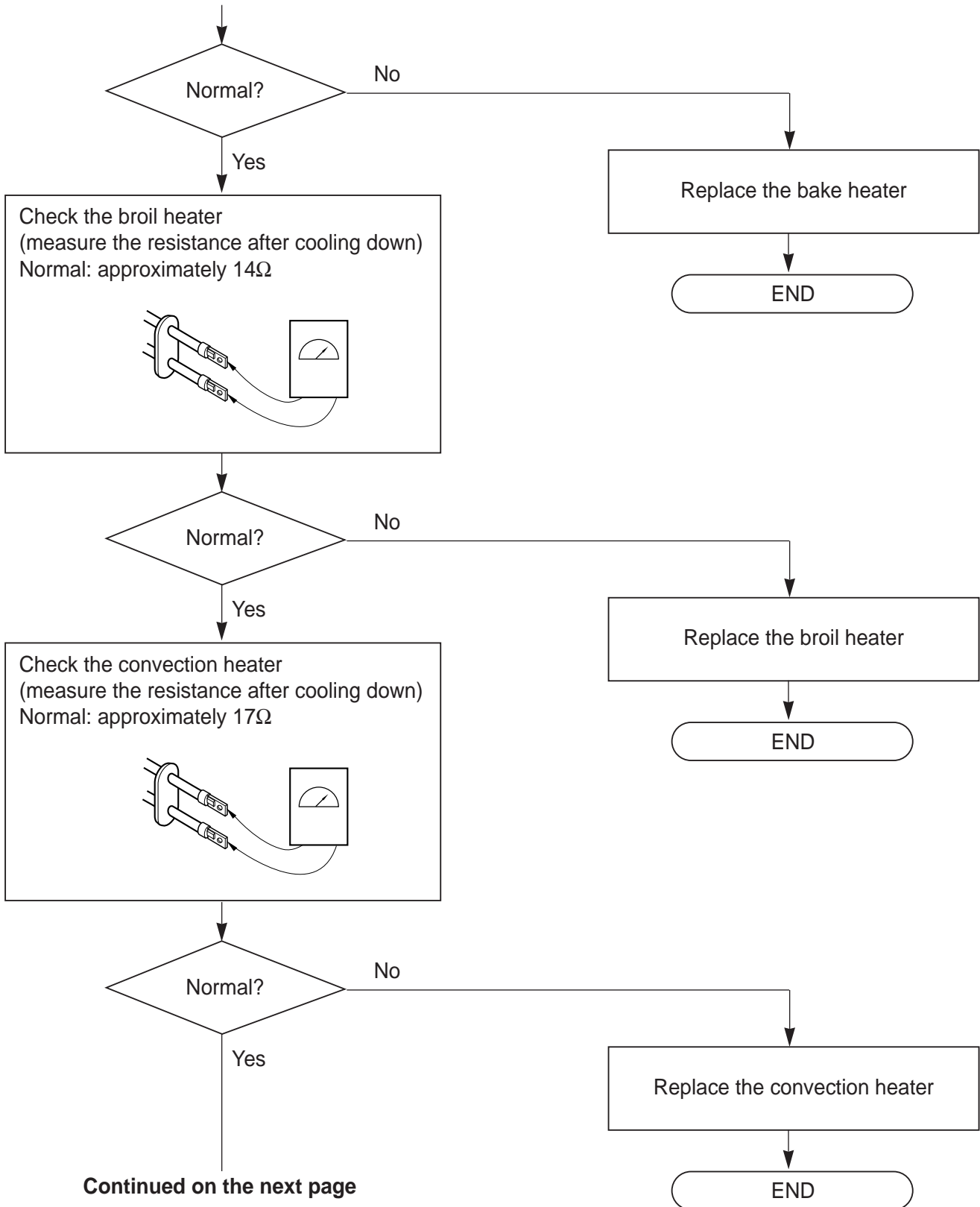

Continued on the next page

# CHECKING FLOW CHART BY FAILURE MODE

Oven does not heat

Check the loose oven sensor connector



Normal?

No

Yes

Reconnect

END

Check the oven sensor  
(measure the resistance after cooling down)  
Normal: approximately 1.09kΩ

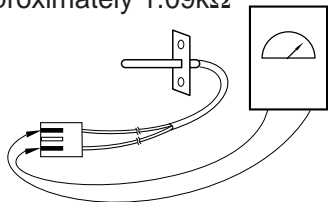

Normal?

No

Yes

Replace the oven sensor

END

Replace the oven relay PCB (012A)

Normal?

Yes

Replace the main PCB(009F)

END

For further check of main PCB  
Refer to the appendix A

# CHECKING FLOW CHART BY FAILURE MODE

## Cook-top does not heat

No heating  
(All or a part of cook-top heaters)

Disconnect power

Check the loose connector board(011D PCB)  
to cook-top heaters and harness defective or not

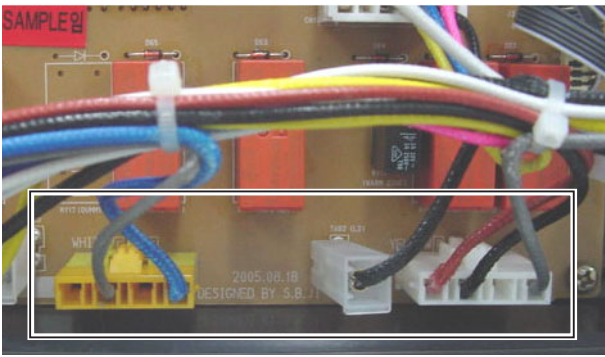

Normal?

No

Yes

Check the loose connector  
(main PCB(009F) CN9 and CN16)

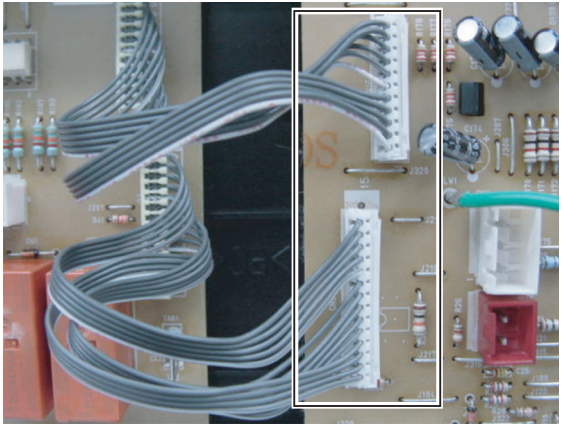

Reconnect.  
If defective harness, replace or fix

END

Continued on the next page

# CHECKING FLOW CHART BY FAILURE MODE

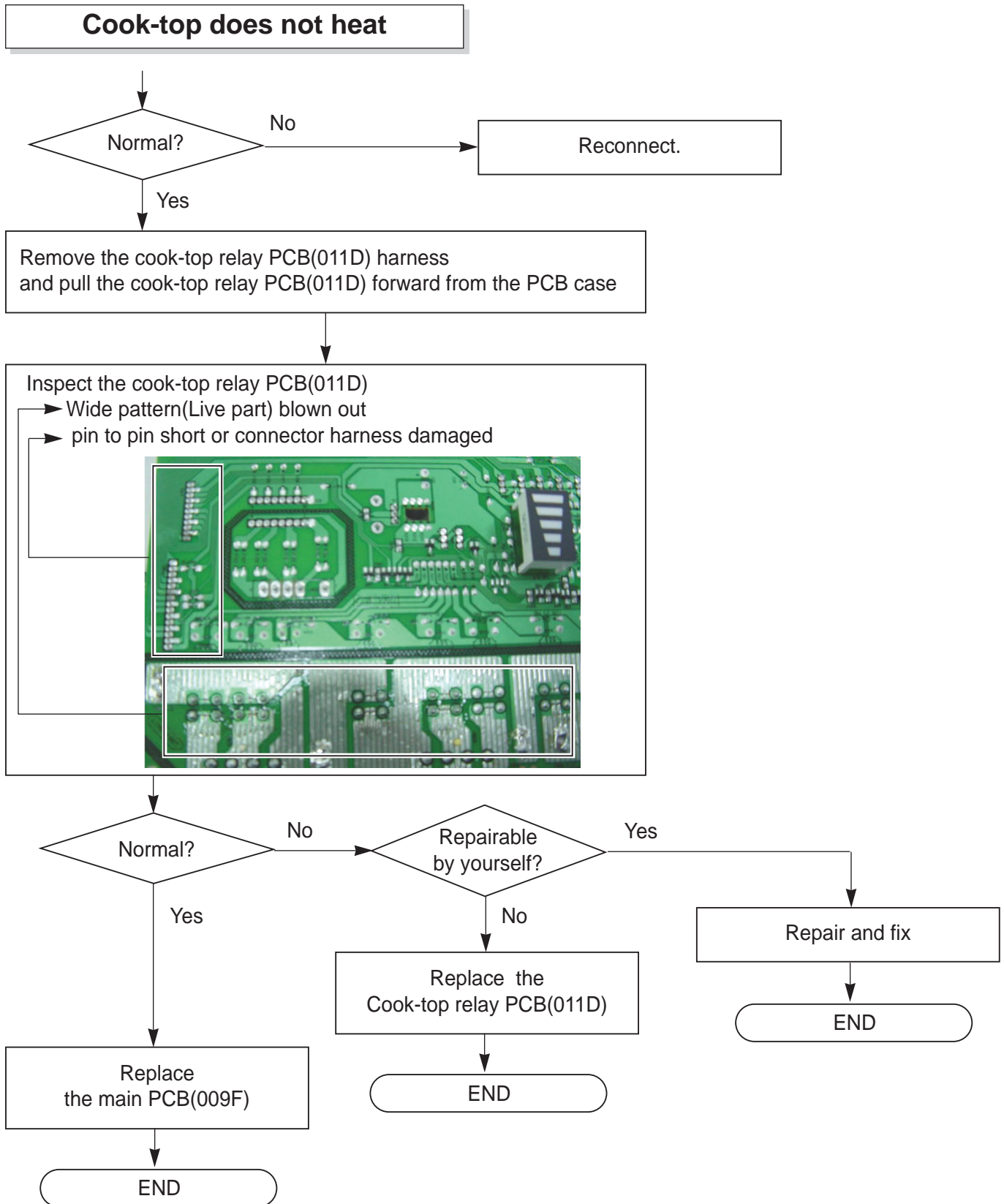

# CHECKING FLOW CHART BY FAILURE MODE

## Oven lamp does not operate

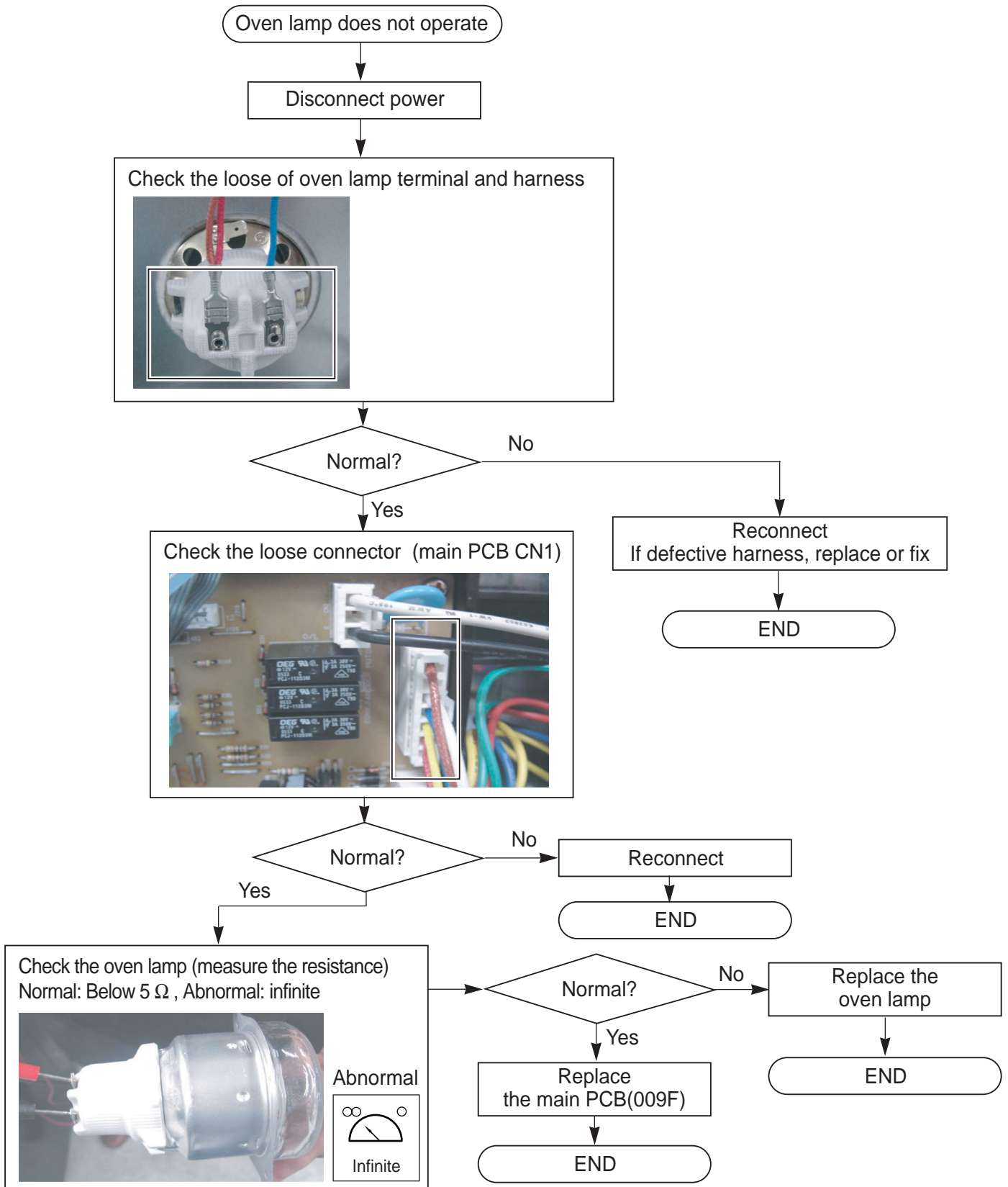

# CHECKING FLOW CHART BY FAILURE MODE

## No key input

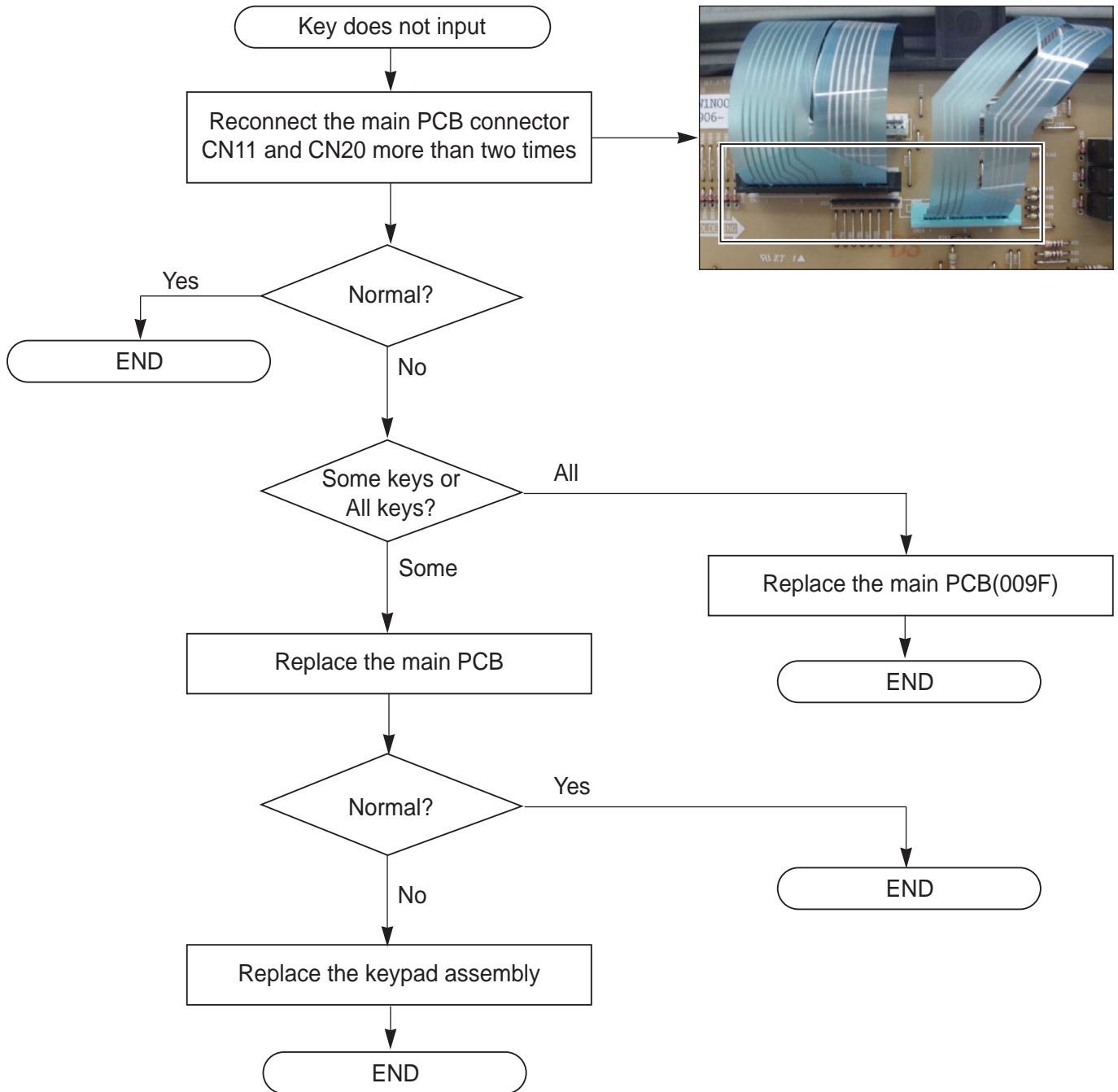

# FAILURE CODES

## WARNING

- **DISCONNECT** power supply cord from the outlet before servicing.
- **Replace all panels and parts before operating.**
- **RECONNECT** all grounding devices.
  - Failure to do so can result in severe personal injury, death or electrical shock.

## "F" (Failure) DISPLAY CODES

Before doing any action, perform the following step1~3.

**Step1.** Unplug range or disconnect power.

**Step2.** Check if connector is fully seated or not.

**Note:** All units in the first few days of use should be checked for mis-wiring or loose connections.

DISPLAY SHOWS	CAUSE	CORRECTIVE ACTION
F1	Key held down too long or shorted key	A. Perform step 1 through 2 above B. Replace keypad or keypad assembly (if F code recur, go to C after unplugging or disconnecting) C. Replace Control (PCB) assembly
F2	Door Locking system don't operate	A. Perform step 1 through 2 above B. Check wire and connections from control to latch C. If motor operate, check integrity of latch mechanism - check the micro-switch (refer to component test section) - check integrity of door locking mechanism D. If motor didn't operate, check continuity of the latch motor and electrical connections - if the wiring is bad, replace the harness - if the wiring is good, replace the door motor assembly - if F code recur, replace control
F3	Main oven Sensor opened	A. Perform step 1 through 2 above B. Open the back panel and check continuity of the sensor and Control (PCB) C. Disconnect sensor from harness
F4	Main oven Sensor shorted	D. - Measure $\Omega$ value between connector pins : Approximately 1090 $\Omega$ (at room temperature: 77F/25°C) - Measure value between sensor chassis and any connector pins : $\Omega$ value should read OPEN => if there is any problem, Replace oven sensor E. If you couldn't find any problem, Replace Control (PCB)

DISPLAY SHOWS	CAUSE	CORRECTIVE ACTION
F5	Warming drawer Sensor shorted	A. Perform step 1 through 2 above B. Open the back panel and check continuity of the sensor and Control (PCB) C. Disconnect sensor from harness D.- Measure $\Omega$ value between connector pins : Approximately 50k $\Omega$ (at room temperature 77F/25°C) - Measure value between sensor chassis and any connector pins : $\Omega$ value should read OPEN => if there is any problem, Replace warming drawer sensor
F6	Warming drawer Sensor open	E. If you couldn't find any problem, Replace Control(PCB)
F7	Main oven heating error	A. Perform step 1 through 2 above B. Open the back panel and check continuity of the sensor, heater (bake, broil) and Control(PCB) C. Check the bake and broil heater(refer to component test) D. Disconnect sensor from harness - Measure $\Omega$ value between connector pins of oven sensor - Measure $\Omega$ value between sensor chassis and any connector pins : $\Omega$ value should read OPEN => if there is any problem, Replace oven sensor E. If you couldn't find any problem, Replace Control(PCB)
F9	Oven is too hot; Bad oven sensor; Bad control (PCB)	A. Perform step 1 through 2 above B. Open the back panel and Disconnect sensor from harness - Measure $\Omega$ value between connector pins : approximately 1090 $\Omega$ (at room temperature :77F/25°C) => if there is any problem, Replace oven sensor C. Check the bake and broil relay (refer to the strip circuit section) STRIP CIRCUITS D. If there is any problem, Replace Control (PCB)

# CHECKING FLOW CHART BY F-CODE

## Key short error → F-1 error

Code	Error mode	Operation	Times/sampling
F-1	Key shorted	When some key is continuously short for $\geq 60$ seconds.	

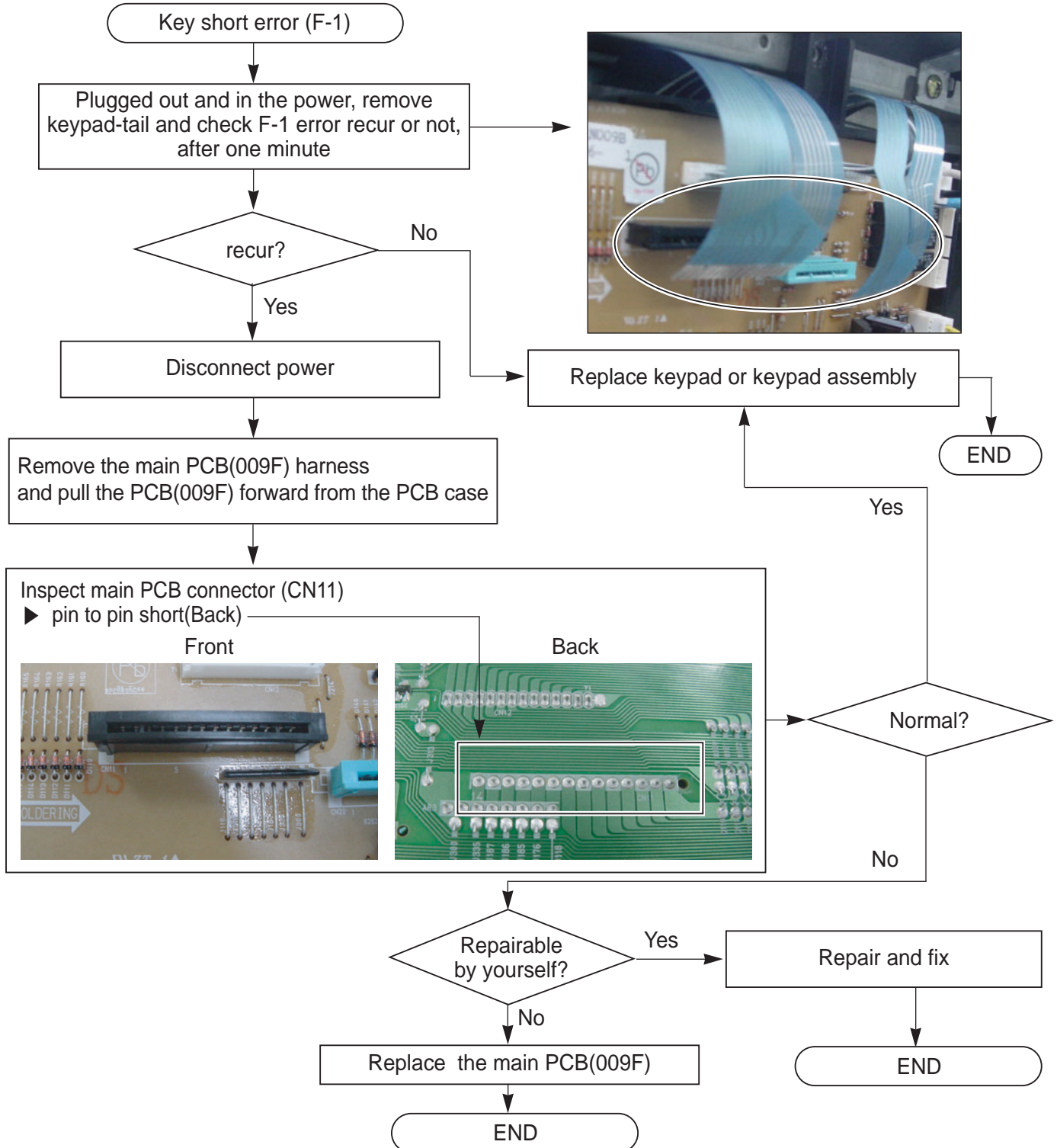



# CHECKING FLOW CHART BY F-CODE

## Door lock system error → F-2 error

Code	Error mode	Operation	Times/sampling
F-2	Door Lock Fail	In case of Door Lock Failure	

→ Just after self-clean start, the door lock motor starts to rotate. During that time if the door lock switch does not operate properly after rotating twice, then supervising circuit detects a Door Lock failure and the F-2 error code appears.

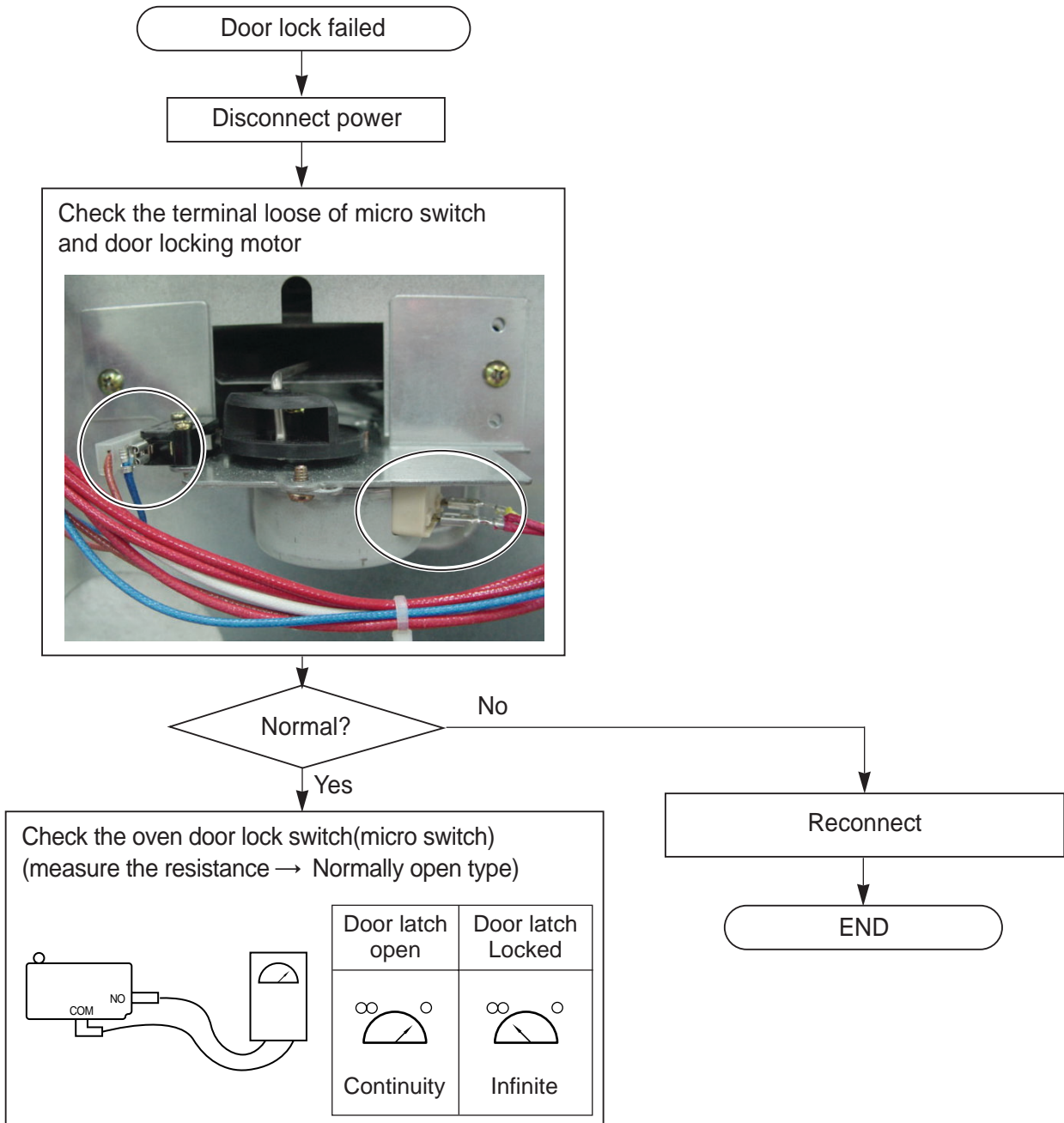

Continued on the next page

# CHECKING FLOW CHART BY F-CODE

Door lock system error → F-2 error

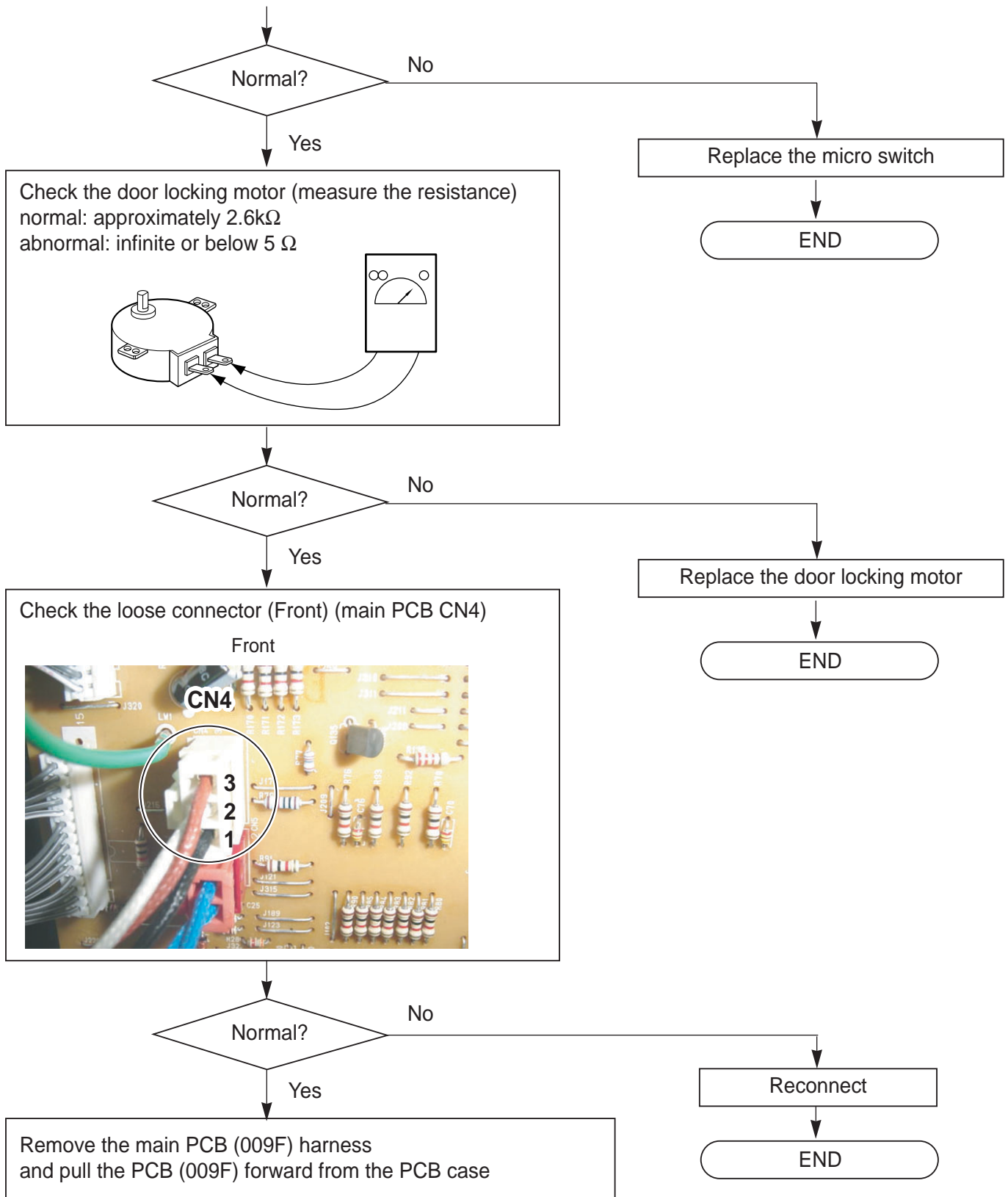

# CHECKING FLOW CHART BY F-CODE

Door lock system error → F-2 error



Inspect connector pin solder of CN4 (Back) (main PCB CN4)

Back

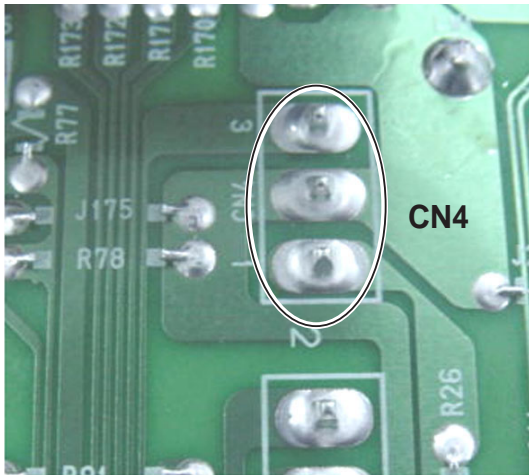

※ If pin solder is cracked, repair and re-use

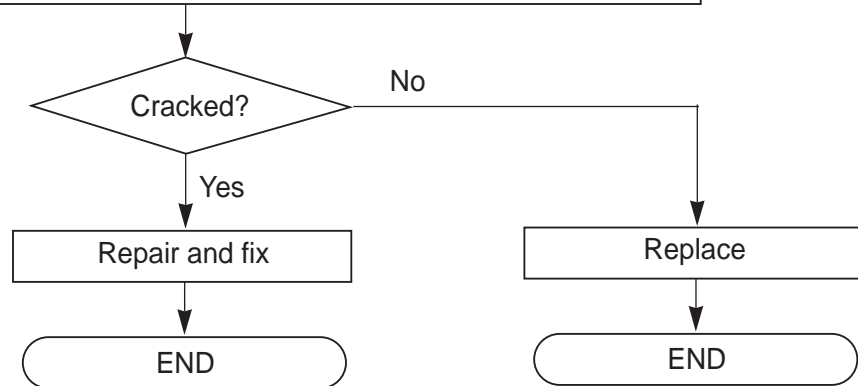

# CHECKING FLOW CHART BY F-CODE

## Main oven sensing error → F-3, F-4 error

Code	Error mode	Operation	Times/sampling
F-3	Opened Sensor	Oven Thermistor remains open for over 1 min, after cook starts	During cook
F-4	Shorted Sensor	Oven Thermistor is short for over 1 min after cook starts	During cook

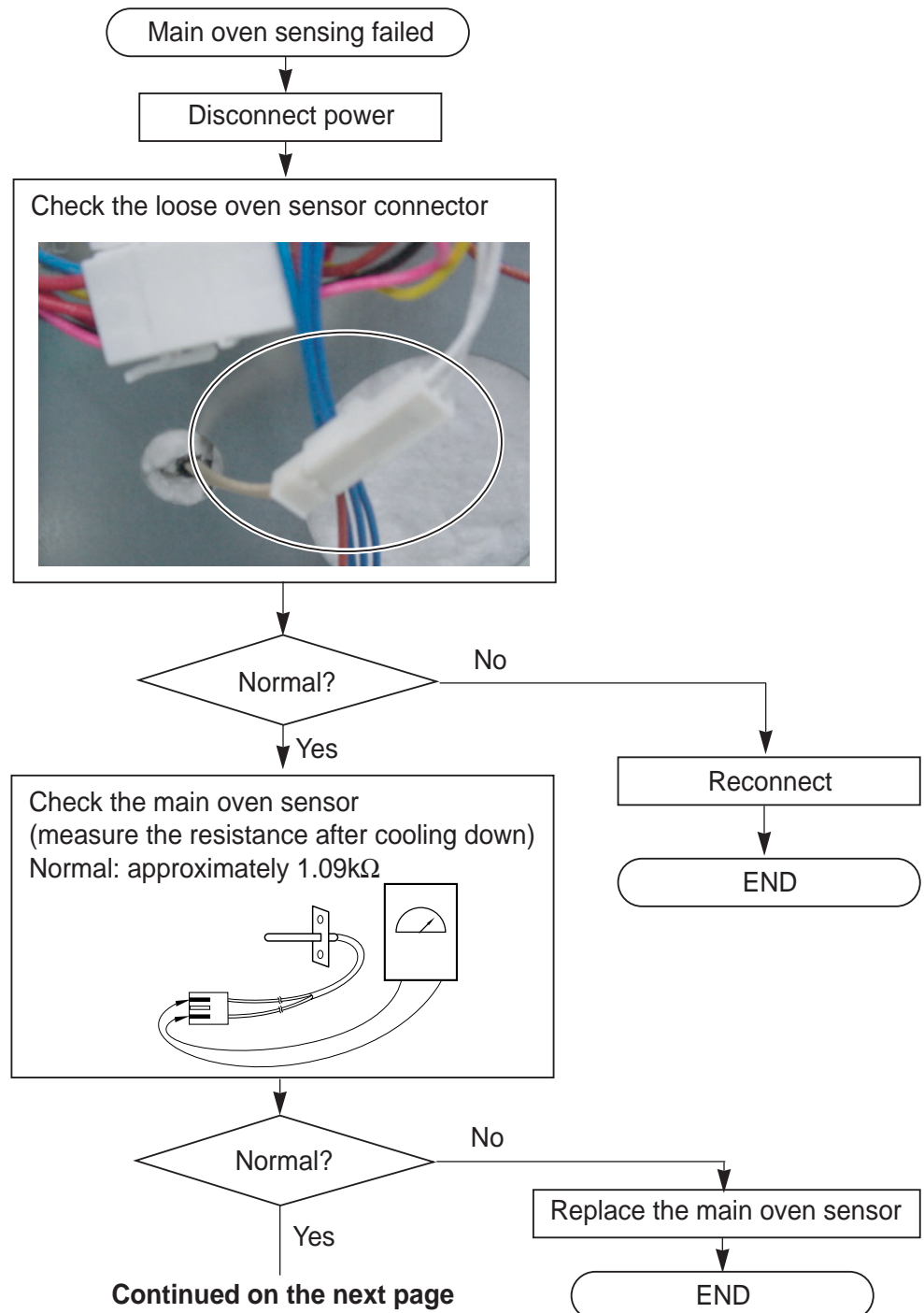

# CHECKING FLOW CHART BY F-CODE

## Main oven sensing error → F-3, F-4 error

Checking the loose connector (Front) (main PCB CN6)

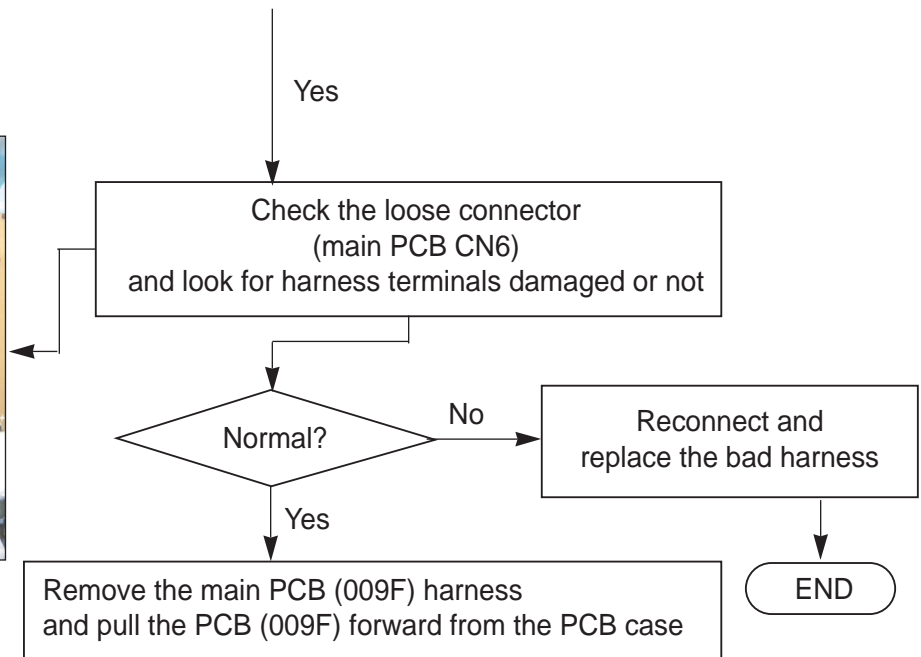
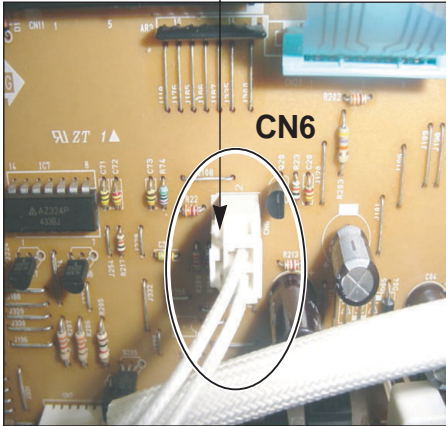

Inspect connector pin solder of CN6 (Back) (main PCB CN6)

Back

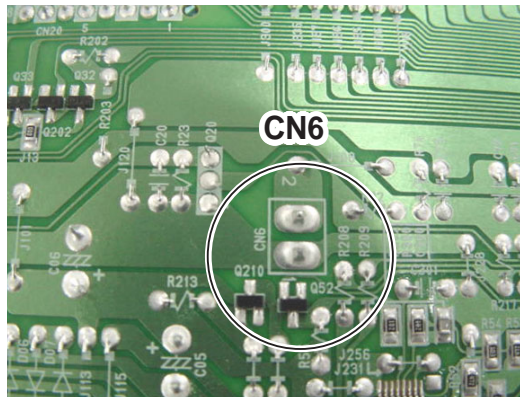

※ If pin solder is cracked, repair and re-use

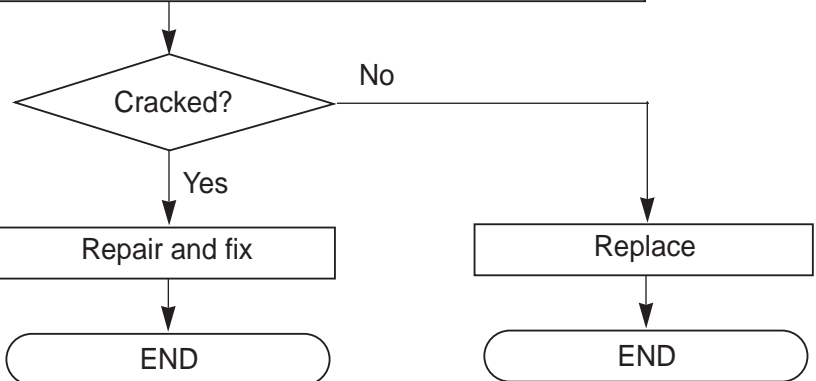

# CHECKING FLOW CHART BY F-CODE

## Warming drawer sensing error → F-5, F-6 error

Code	Error mode	Operation	Times/sampling
F-5	Shorted Sensor	Warm Drawer Thermistor short Over 1 min after warm drawer operates	During operate
F-6	Opened Sensor	Warm Drawer Thermistor open Over 1 min after warm drawer operates	During operate

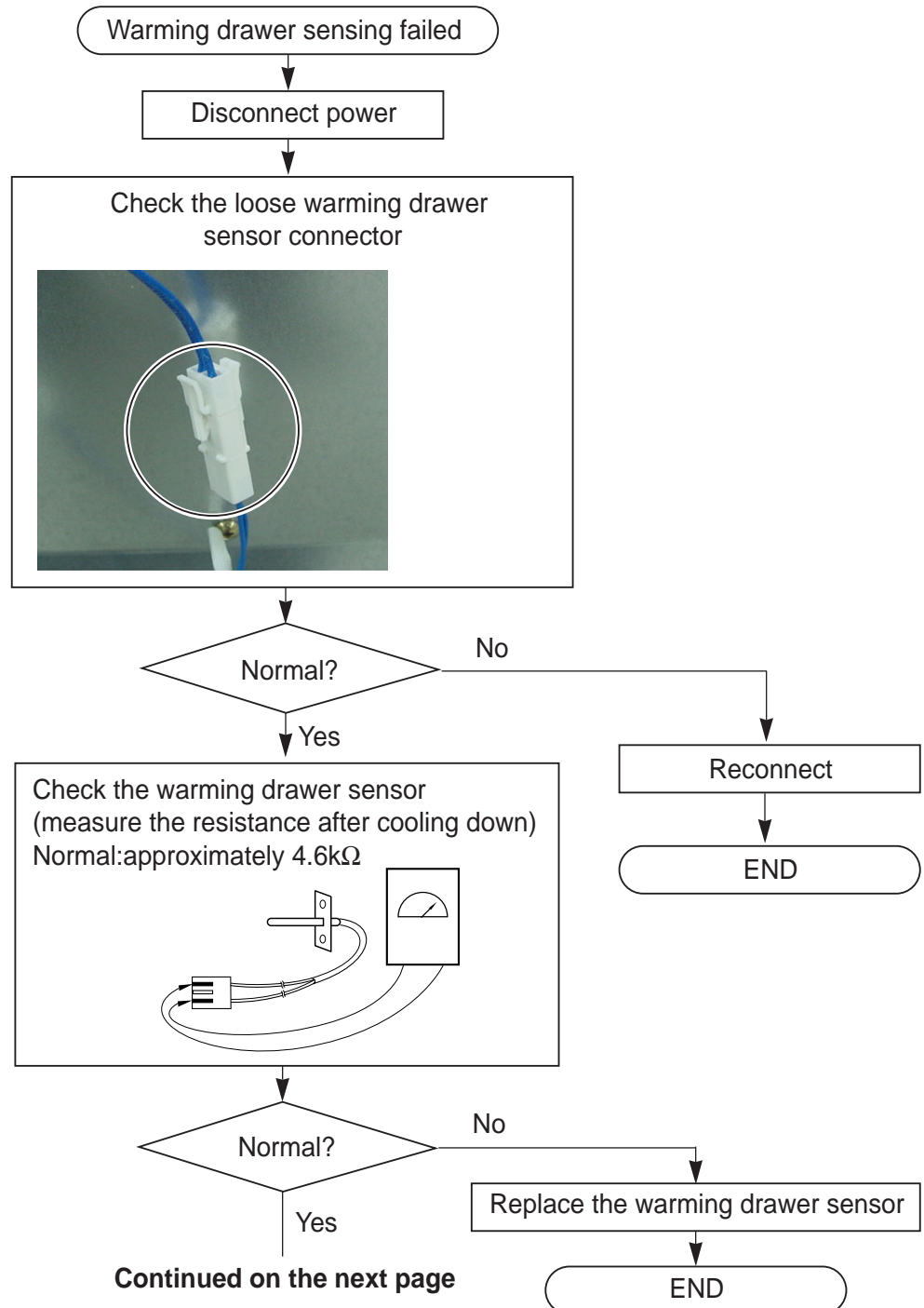

# CHECKING FLOW CHART BY F-CODE

## Warming drawer sensing error → F-5, F-6 error

Checking the loose connector  
(Front) (main PCB CN5)

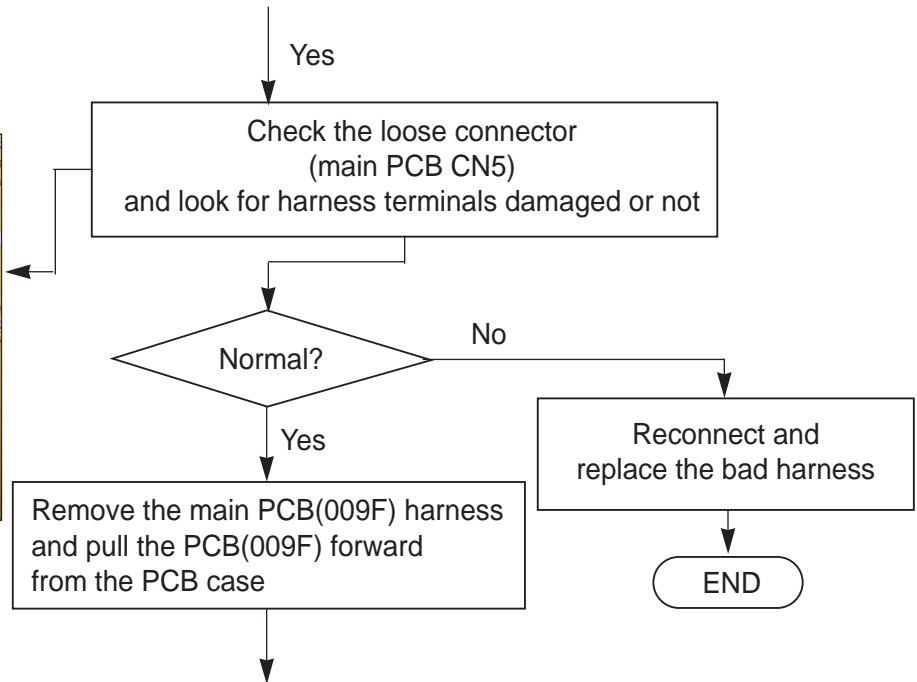
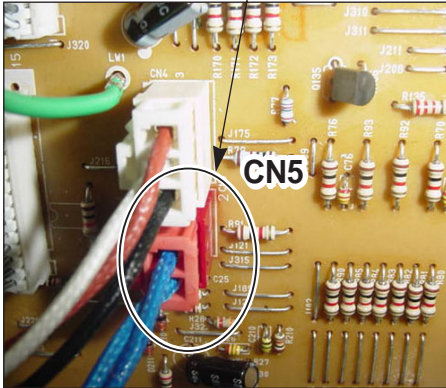

Inspect connector pin solder of CN5 (Back) (main PCB CN5)

Back

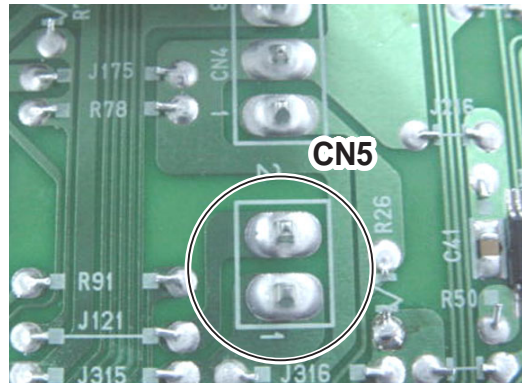

※ If pin solder is cracked,  
repair and re-use

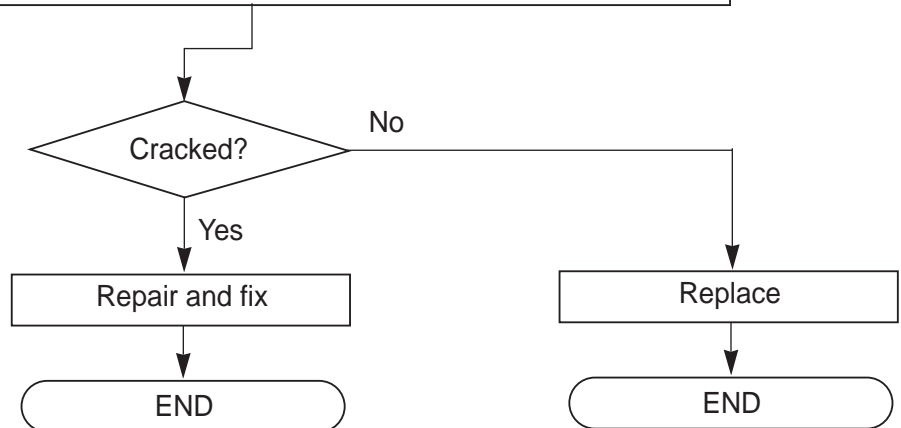

# CHECKING FLOW CHART BY F-CODE

## Oven too hot error → F-9 error

Code	Error mode	Operation	Times/sampling
F-9	Oven hot	Oven temperature is over 650°F continuously during 2 minutes on cooking.	During cook (Not self clean mode)

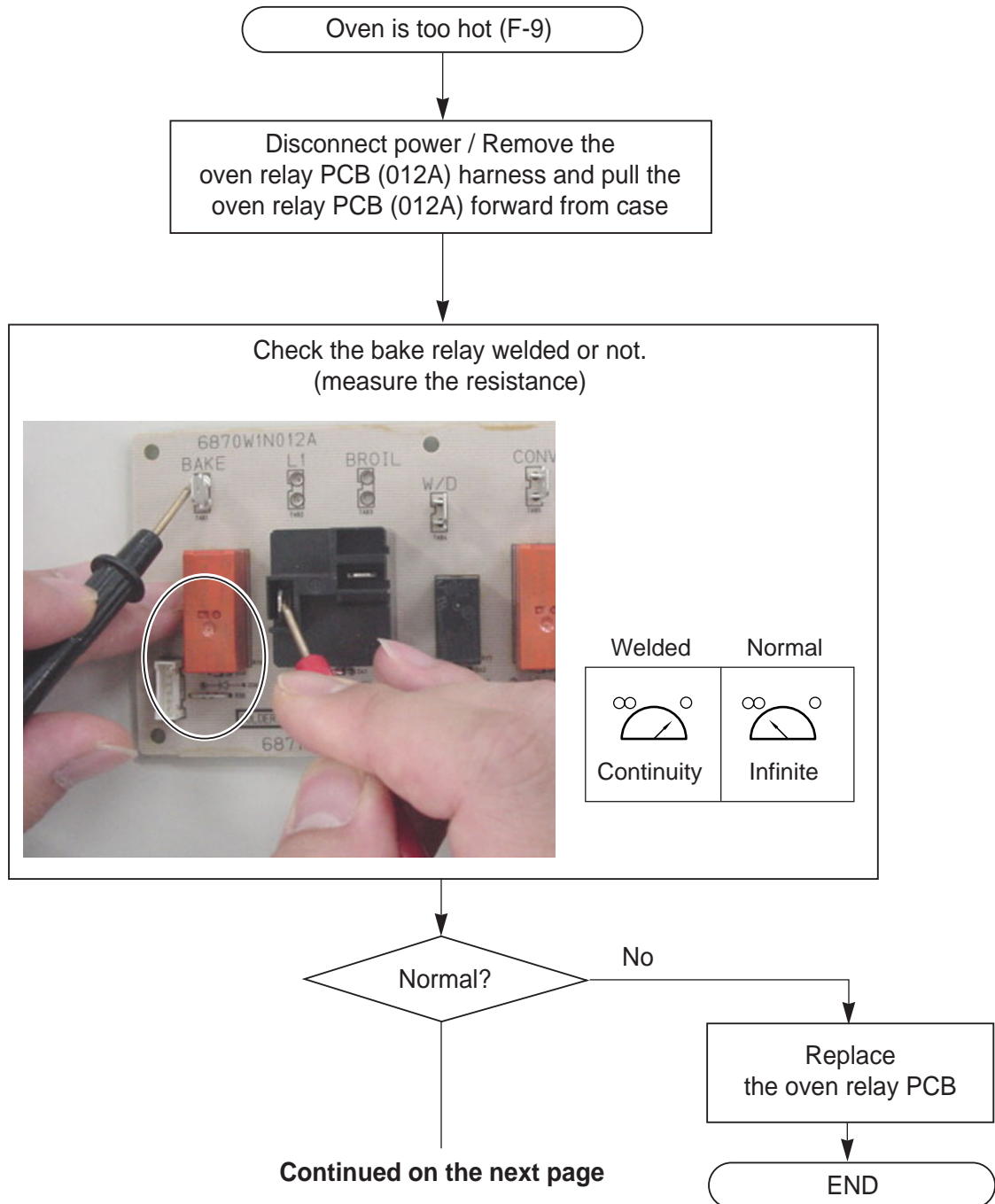



# CHECKING FLOW CHART BY F-CODE

Oven too hot error → F-9 error

Yes

Check the broil relay welded or not.  
(measure the resistance)

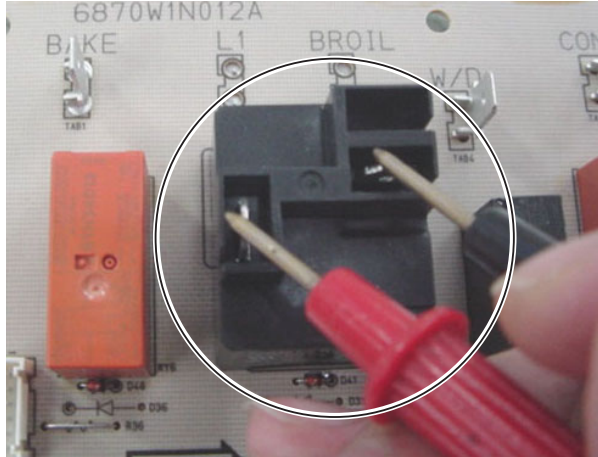

Welded

Normal

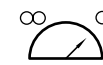

Continuity

Infinite

Normal?

No

Yes

Replace  
the oven relay PCB(012A)

Replace  
the main relay PCB(009F)

END

END

# TROUBLE SHOOTING

PROBLEMS	POSSIBLE CAUSES & FAULTS	SOLUTIONS
Oven not operating.	<ul style="list-style-type: none"> <li>• Bad power control board (PCB)</li> <li>• Power outage</li> </ul>	<ul style="list-style-type: none"> <li>• Test and/or replace PCB → Refer to the page 6-1~6-4</li> <li>• Verify power is present at unit.</li> <li>• Verify that the circuit breaker is not tripped</li> <li>• Replace household fuse capacity</li> </ul>
Oven element does not heat.	<ul style="list-style-type: none"> <li>• No line voltage</li> <li>• Loose or bad wiring.</li> <li>• Defective element.</li> <li>• Bad Power control board(PCB)</li> </ul>	<ul style="list-style-type: none"> <li>• Check circuit breaker.</li> <li>• Repair or replace wiring (see wiring diagrams).</li> <li>• Test and/or replace element.</li> <li>• Test and/or replace PCB → Refer to the page 6-5~6-7</li> </ul>
Surface element barely heats Surface element will not heat Higher than low-medium	<ul style="list-style-type: none"> <li>• Loose or bad wiring connection at element or terminal block.</li> <li>• Defective Surface units control PCB</li> <li>• Defective Surface element.</li> <li>• Low line voltage</li> </ul>	<ul style="list-style-type: none"> <li>• Verify all connections are clean and tight, replace broken wires</li> <li>• Test and/or replace cook-top PCB → Refer to the page 6-8~6-9</li> <li>• Test and/or replace element.</li> <li>• Line voltage should be minimum 240-volts. Of necessary, electrician should repair cause for low line voltage</li> </ul>
Frequent cycling of surface Element or warming zone	<ul style="list-style-type: none"> <li>• This is normal</li> </ul>	<ul style="list-style-type: none"> <li>• The element will cycle on and off to maintain the heat setting</li> </ul>
“HS” (Hot surface)Warning message does not light up	<ul style="list-style-type: none"> <li>• Defective cook-top control PCB</li> </ul>	<ul style="list-style-type: none"> <li>• Test and/or replace cook-top PCB</li> </ul>
Oven light fails to operate. (Refer to the page 6-10)	<ul style="list-style-type: none"> <li>• Failed oven lamp.</li> <li>• Circuit breaker or fuse is open</li> <li>• Loose or bad wiring</li> <li>• Defective light socket.</li> <li>• Defective door switch</li> </ul>	<ul style="list-style-type: none"> <li>• Check lamp and Replace is necessary</li> <li>• Check circuit breaker or replace fuse.</li> <li>• Repair or replace wiring</li> <li>• Check light socket for continuity.</li> <li>• Test and/or replace door switch</li> </ul>
Oven does not begin clean cycle  Oven stop for Self clean cycle	<ul style="list-style-type: none"> <li>• Bad wiring</li> <li>• Bad latch system</li> <li>• Programming error</li> <li>• Defective a point of contact with door switch</li> </ul>	<ul style="list-style-type: none"> <li>• Repair or replace wiring</li> <li>• Check door locking motor and micro switch</li> <li>• Shut off power to oven for five minutes by switching off circuit breaker. Reset circuit breaker and try oven again.</li> <li>• Test door switch and check the point of contact between door and door switch</li> </ul>

# TROUBLE SHOOTING

PROBLEMS	POSSIBLE CAUSES & FAULTS	SOLUTIONS
Electronic timer will not accept Programming.	<ul style="list-style-type: none"> <li>Failed main power control board</li> </ul>	<ul style="list-style-type: none"> <li>Replace power control board(PCB)</li> </ul>
Electronic timer will not accept Programming.	<ul style="list-style-type: none"> <li>Failed main power control board</li> </ul>	<ul style="list-style-type: none"> <li>Replace power control board(PCB)</li> </ul>
Clock and timer not working	<ul style="list-style-type: none"> <li>Power outage</li> </ul>	<ul style="list-style-type: none"> <li>Verify power is present at unit.</li> <li>Verify that the circuit breaker is not tripped</li> <li>Replace household fuse, but do not fuse capacity</li> <li>Refer to Owner's manual instructions</li> </ul>
Oven does not bake (Selection is set for to BAKE or TIMED BAKE)	<ul style="list-style-type: none"> <li>Loose or bad wiring</li> <li>Defective BAKE element</li> <li>Defective electronic clock</li> <li>Door switch sensing error</li> </ul>	<ul style="list-style-type: none"> <li>Verify all connections are clean and tight, replace broken wire</li> <li>Test and/or replace BAKE element.</li> <li>Replace power control board(PCB)</li> <li>Test door switch and check the point of contact between door and door switch</li> </ul>
Oven does not Broil	<ul style="list-style-type: none"> <li>Loose or bad wiring</li> <li>Defective BROIL element</li> <li>Defective Power Control Board</li> </ul>	<ul style="list-style-type: none"> <li>Verify all connections are clean and tight, replace broken wire</li> <li>Test and/or replace BAKE element.</li> <li>Replace power control board(PCB)</li> </ul>
Overheating or "runaway" oven	<ul style="list-style-type: none"> <li>Loose or bad wiring to latch system</li> <li>Defective Oven Sensor</li> <li>Bad Power Control Board(PCB)</li> </ul>	<ul style="list-style-type: none"> <li>Repair or replace wiring</li> <li>Test and/or replace Oven Sensor</li> <li>Test and/or replace PCB</li> </ul>
Oven door will not open or latch.	<ul style="list-style-type: none"> <li>Defective latch mechanism.</li> <li>Defective(bent)door latch lever.</li> <li>Oven is still hot. Cool-down period after self-clean cycle not complete</li> </ul>	<ul style="list-style-type: none"> <li>Replace door latch system.</li> <li>Replace latch lever</li> <li>This is normal. Wait until LOCK icon will goes out.</li> </ul>
Premature burnout of bake element	<ul style="list-style-type: none"> <li>Improper use of oven(e.g. being used to heat the home)</li> </ul>	<ul style="list-style-type: none"> <li>Use oven for baking only</li> </ul>
Oven door difficult to open	<ul style="list-style-type: none"> <li>Worn or broken broil stop roller.</li> </ul>	<ul style="list-style-type: none"> <li>Replace oven door hinge</li> </ul>

# TROUBLE SHOOTING

PROBLEMS	POSSIBLE CAUSES & FAULTS	SOLUTIONS
Oven door sagging on one side	<ul style="list-style-type: none"> <li>• Hinge loose or out of position to oven liner</li> </ul>	<ul style="list-style-type: none"> <li>• Adjust hinges or replace hinges</li> </ul>
Door does not close completely at top	<ul style="list-style-type: none"> <li>• Broken or misadjusted door spring</li> <li>• Door fits too tight at bottom.</li> </ul>	<ul style="list-style-type: none"> <li>• Adjust or replace hinges</li> <li>• Adjust hinges outward.</li> </ul>
Door glass breaks.	<ul style="list-style-type: none"> <li>• Oven racks covered with foil.</li> <li>• Glass installed backward.</li> </ul>	<ul style="list-style-type: none"> <li>• Do not cover racks with foil.</li> <li>• Install tempered glass toward the heat.</li> </ul>
Damaged oven door gasket.	<ul style="list-style-type: none"> <li>• Improper Self clean</li> </ul>	<ul style="list-style-type: none"> <li>• Do not use harsh abrasives or scouring pads. See Owner's manual instructions</li> </ul>
Oven racks fit too tight.	<ul style="list-style-type: none"> <li>• Racks were cleaned in self clean cycle</li> <li>• Tolerance buildup in oven liner.</li> </ul>	<ul style="list-style-type: none"> <li>• Apply a small amount of vegetable oil to a paper towel and wipe the edges of the oven racks with the paper towel. Do not spray with pam or other lubricant sprays.</li> <li>• Notify customer Assurance department.</li> </ul>
Oven smokes/odor first few times of usage	<ul style="list-style-type: none"> <li>• This is normal</li> </ul>	<ul style="list-style-type: none"> <li>• Minor smoking or odor is normal for the first few times of oven usage</li> <li>• Ventilate area well and perform self clean cycle</li> </ul>
Excessive smoking during a Self clean cycle	<ul style="list-style-type: none"> <li>• Excessive soil</li> </ul>	<ul style="list-style-type: none"> <li>• Press the CLEAR/OFF pad. Open the windows to rid the room of smoke. Wait until the Self Clean cycle is cancelled. Wipe up the excess soil and reset the clean</li> </ul>
Convection fan make a noise	<ul style="list-style-type: none"> <li>• A convection fan may automatically turn on and off. Low level noise is normal</li> <li>• Loose nut of convection fan</li> <li>• Deformed convection fan</li> </ul>	<ul style="list-style-type: none"> <li>• Low level noise is normal</li> <li>• Re-fasten the nut</li> <li>• Replace the convection fan.</li> </ul>
Failures Codes	<ul style="list-style-type: none"> <li>• Electronically controlled</li> </ul>	<ul style="list-style-type: none"> <li>• Refer to "Failure codes" parts (page 7-0~7-10)</li> </ul>
Oven temperature too hot or too cold	<ul style="list-style-type: none"> <li>• Oven sensor needs to be adjusted</li> </ul>	<ul style="list-style-type: none"> <li>• See "the adjusting your oven temperature" in owners manual</li> </ul>

# SCHEMATIC DIAGRAM

**⚠ WARNING**  
**POWER MUST BE DISCONNECTED BEFORE SERVICING THE APPLIANCE**

※ RADIANT COOK-TOP

Wattage	Ω
RR:1200W	approx.47Ω
LR:1200W	approx.47Ω
LF:2500W	approx.23Ω
RF(Right Front) :1700W(inner) :2700W(Dual)	approx.32Ω approx.56Ω
CR:100W	approx.570Ω

WIRE COLORS

SYMBOL	COLOR
WH	WHITE
BK	BLACK
RD	RED
YL	YELLOW
PK	PINK
BL	BLUE
BN	BROWN
GN	GREEN
GY	GRAY

**NOTE:** Schematic diagram shows door switch in the cook position with the oven door open and elements off.

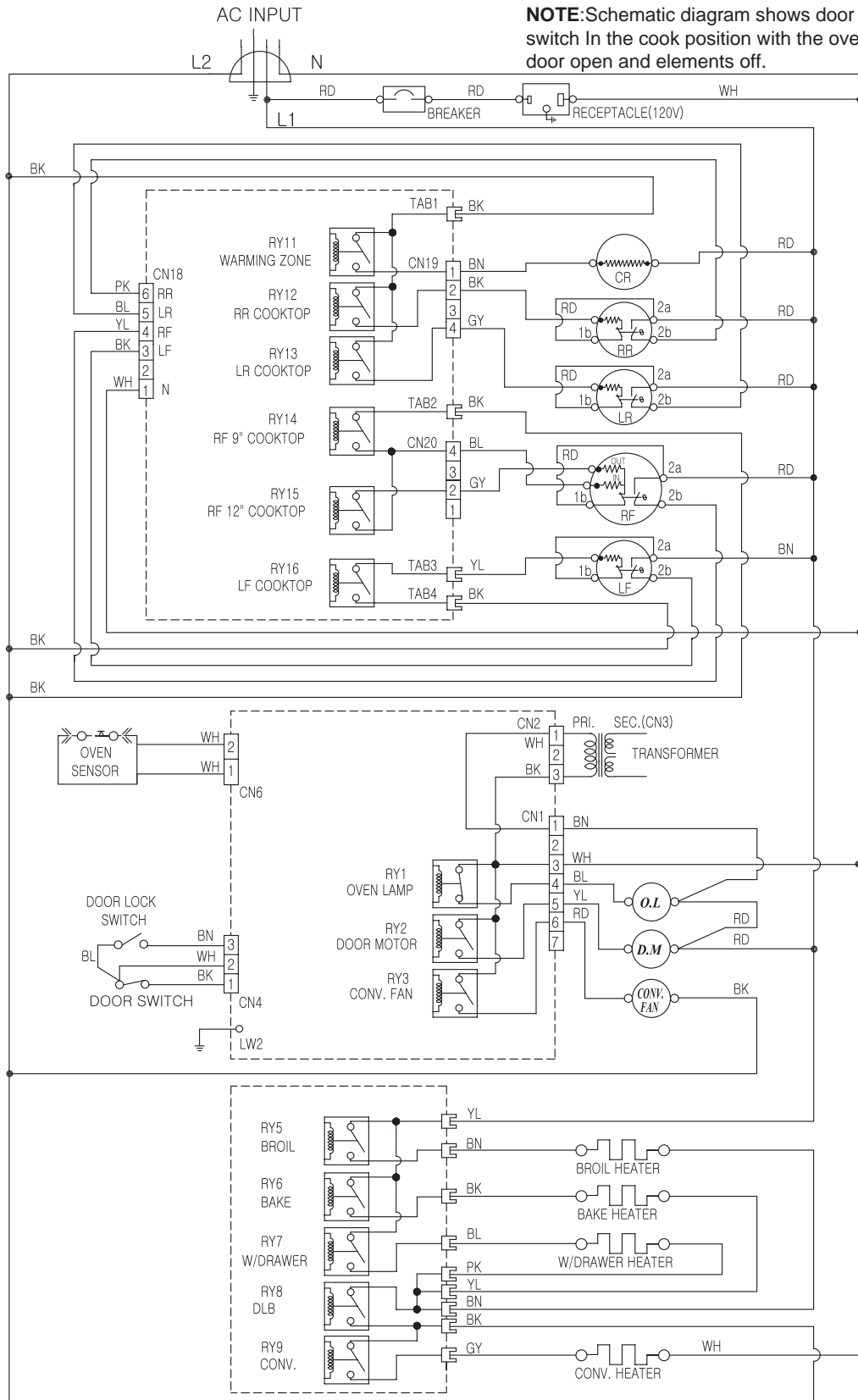

# STRIP CIRCUITS

Complete the following steps before checking electric oven circuit :

1. Check the line voltage, household fuse or circuit breaker.
2. Check for loose wiring or mis-wiring within electric range.

**NOTE:** The following individual circuits are for use in diagnosis, and are shown in the ON position.

## BAKE / COOK & WARM / PROOF

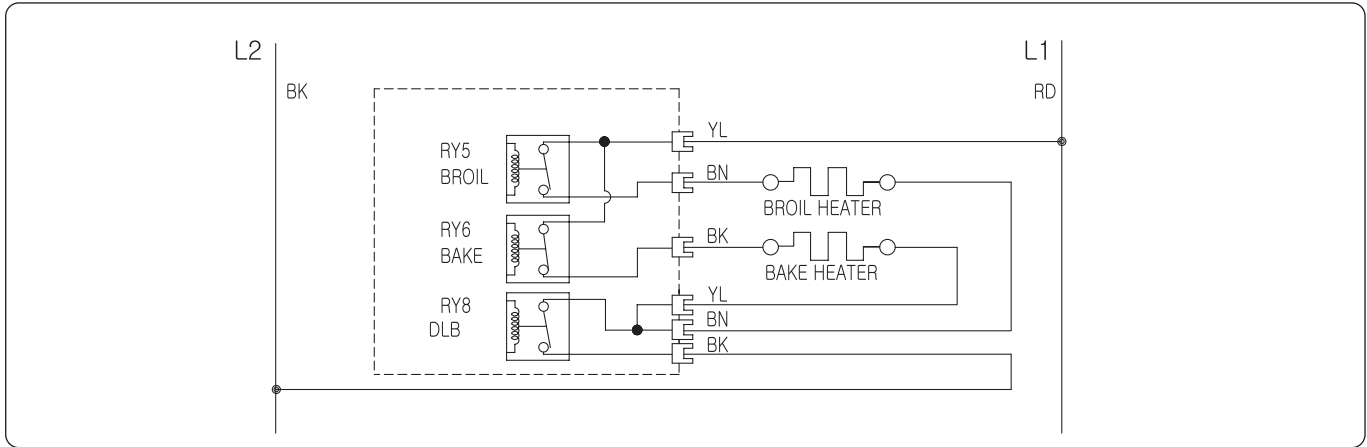

## BROIL

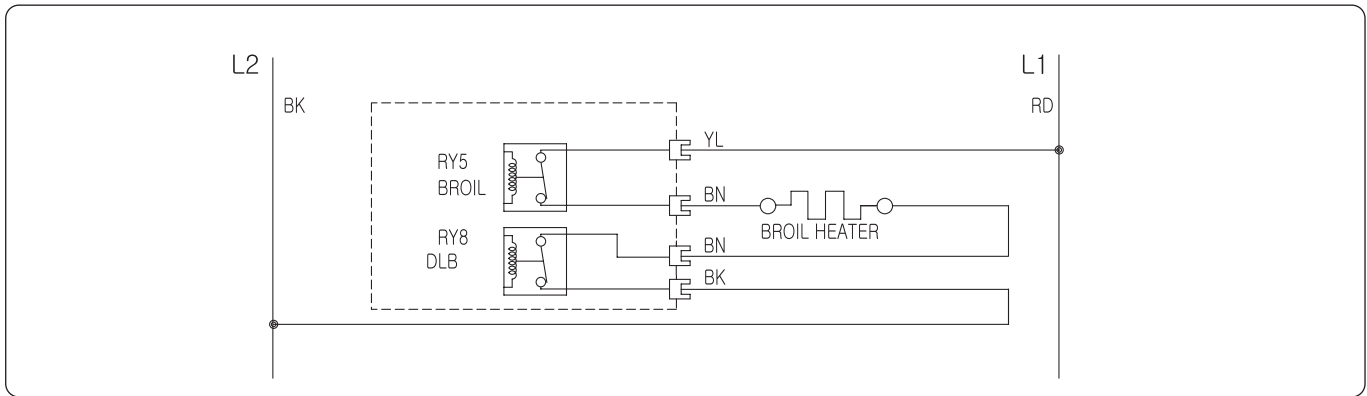

## OVEN LIGHT

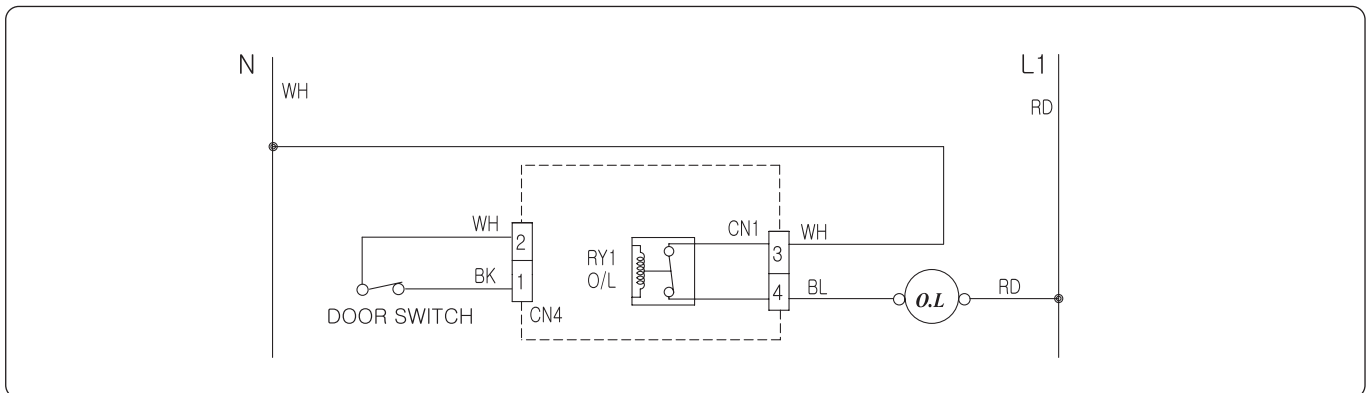

## WARMING DRAWER

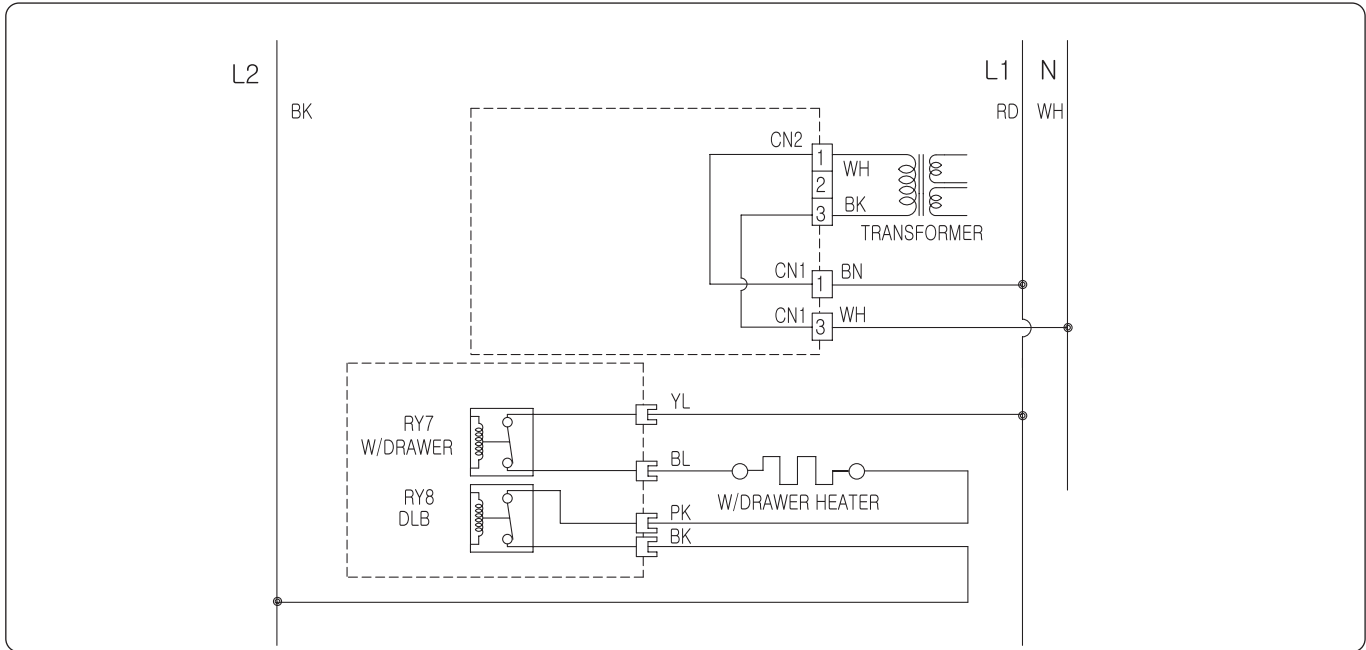

## SELF CLEANING

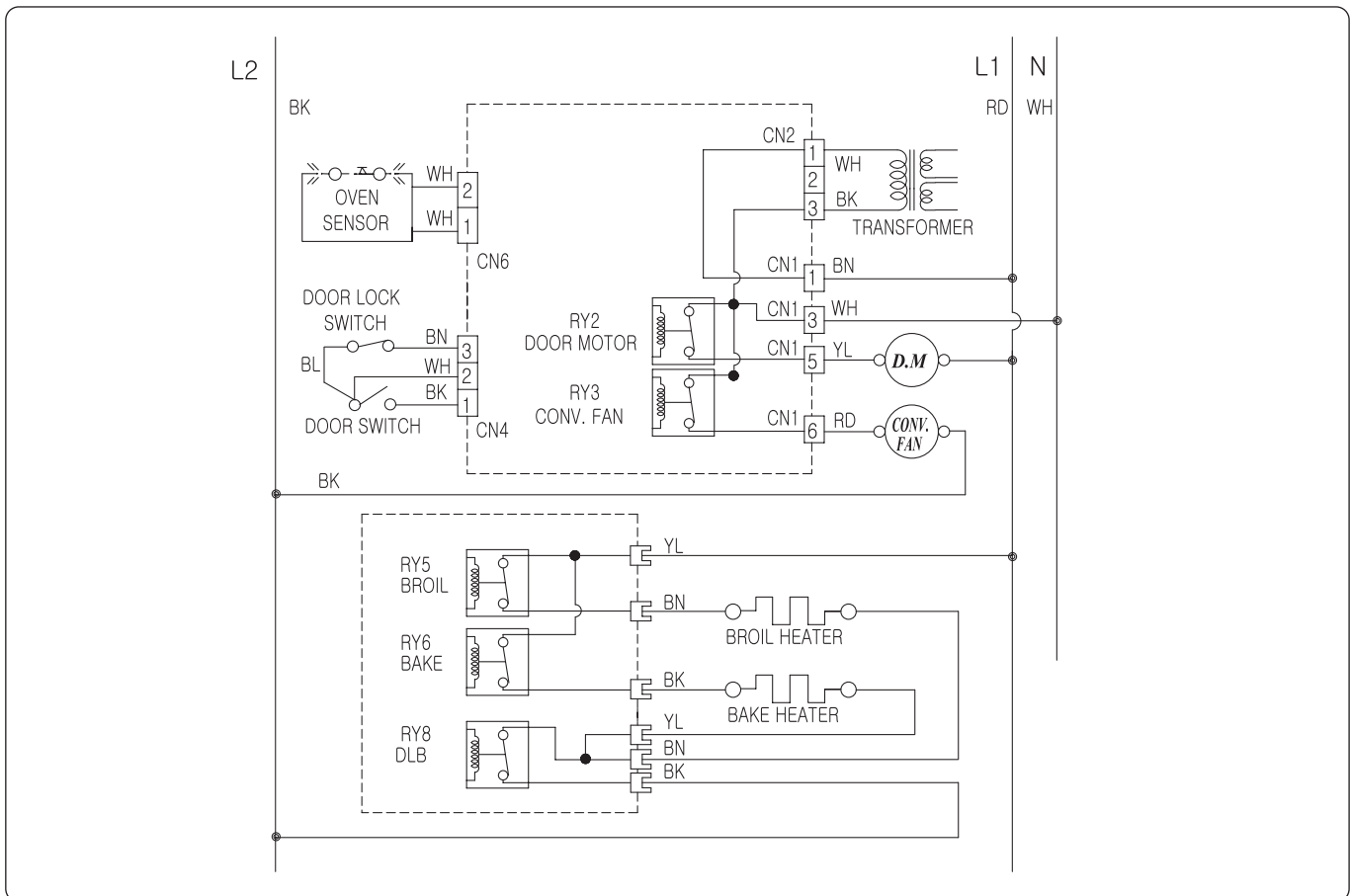

### CLOCK DISPLAY ON

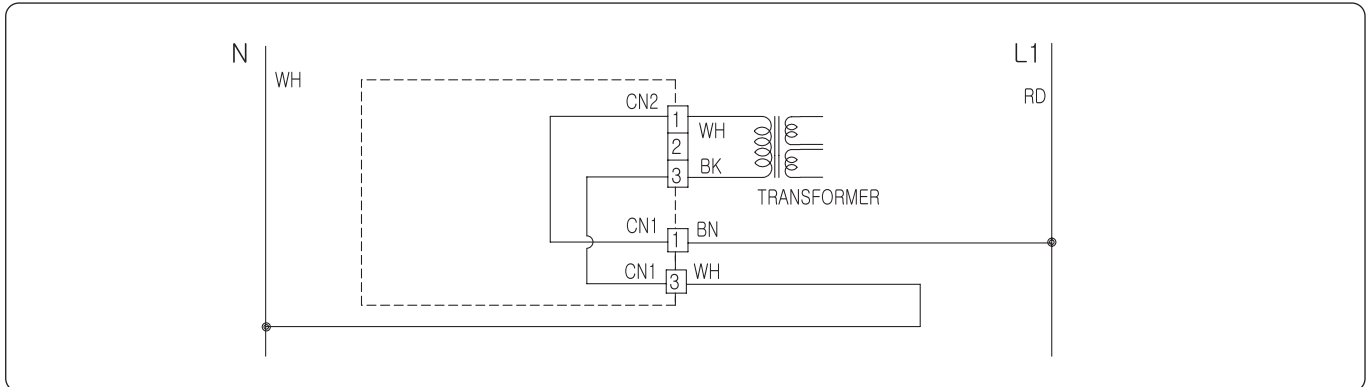

### CONV. BAKE / CONV. ROAST

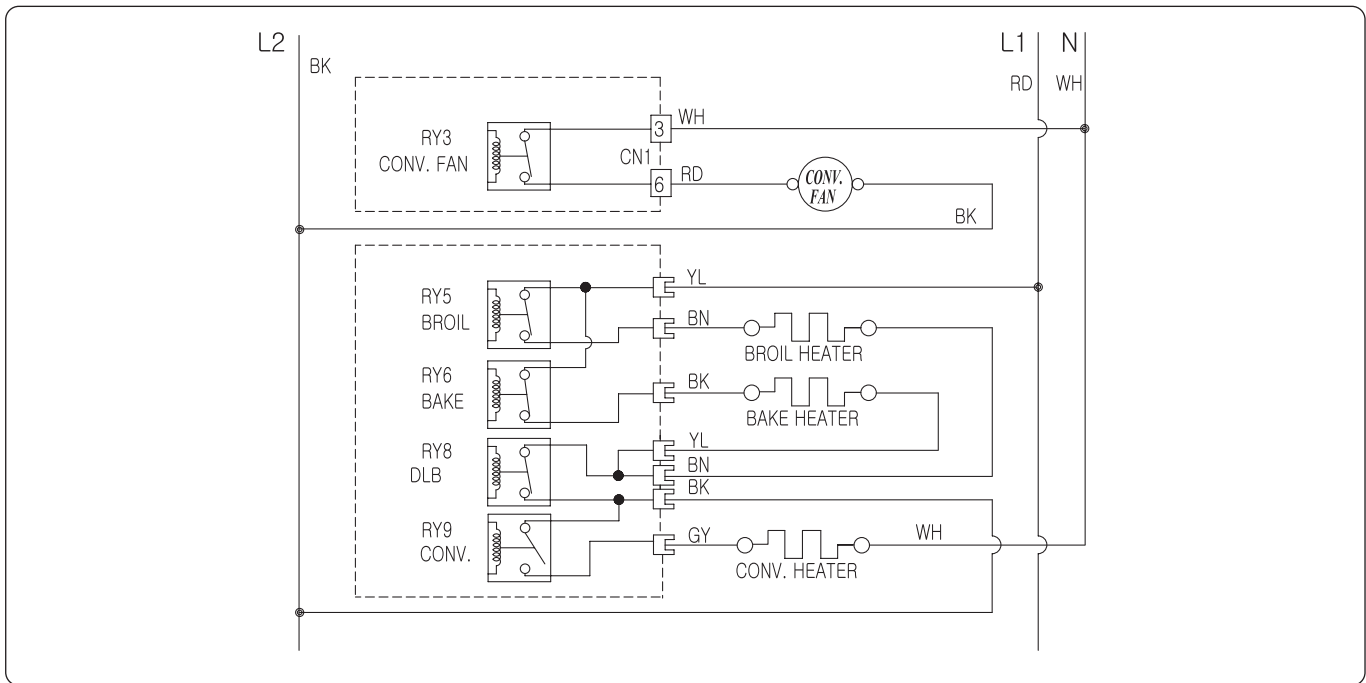

### CR (Warming Zone)

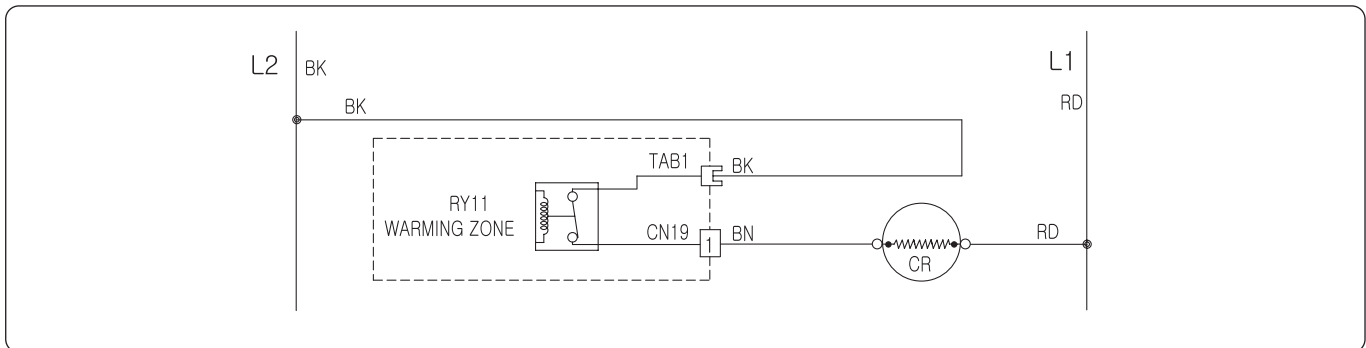



### RR Cook-top Element

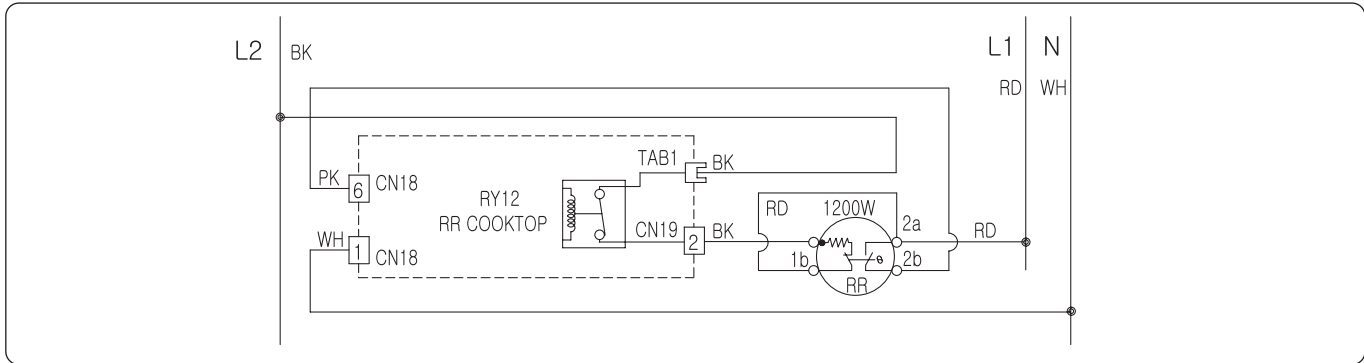

### LR Cook-top Element

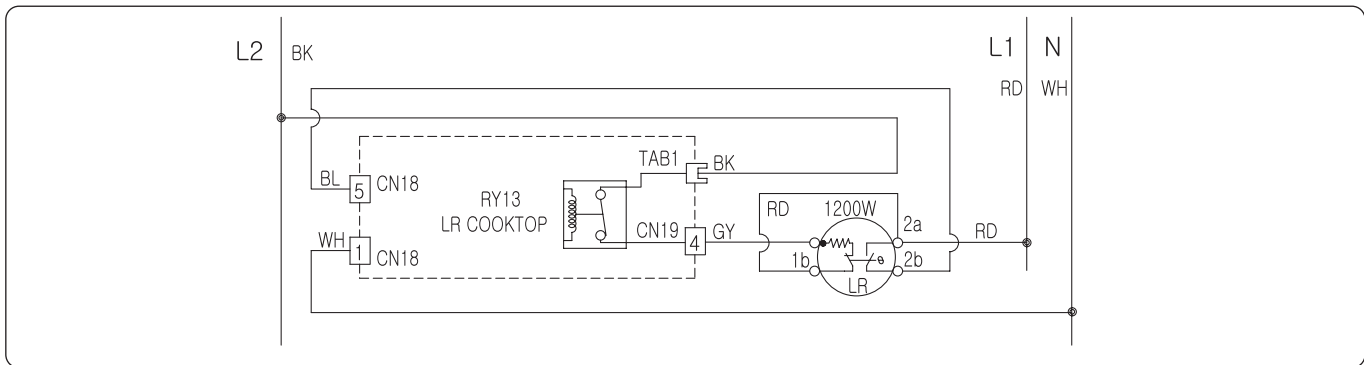

### LF Cook-top Element

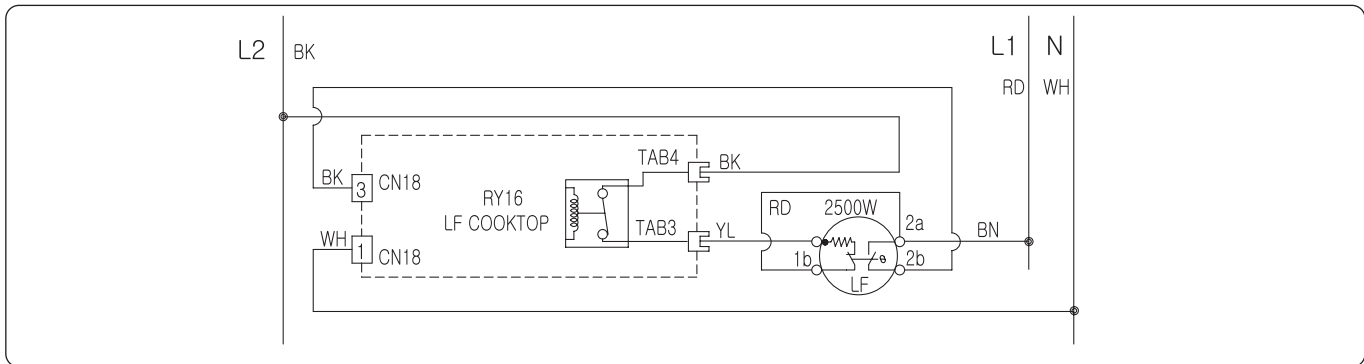

### RF Cook-top Element

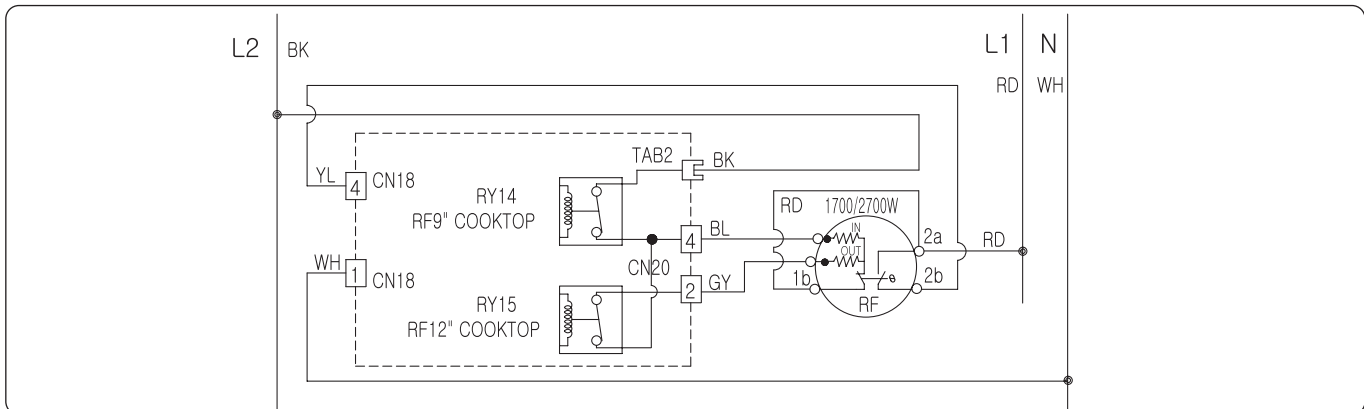

# EXPLODED VIEW

## INTRODUCTION (I)

For Model: LSC5683WW  
LSC5683WB

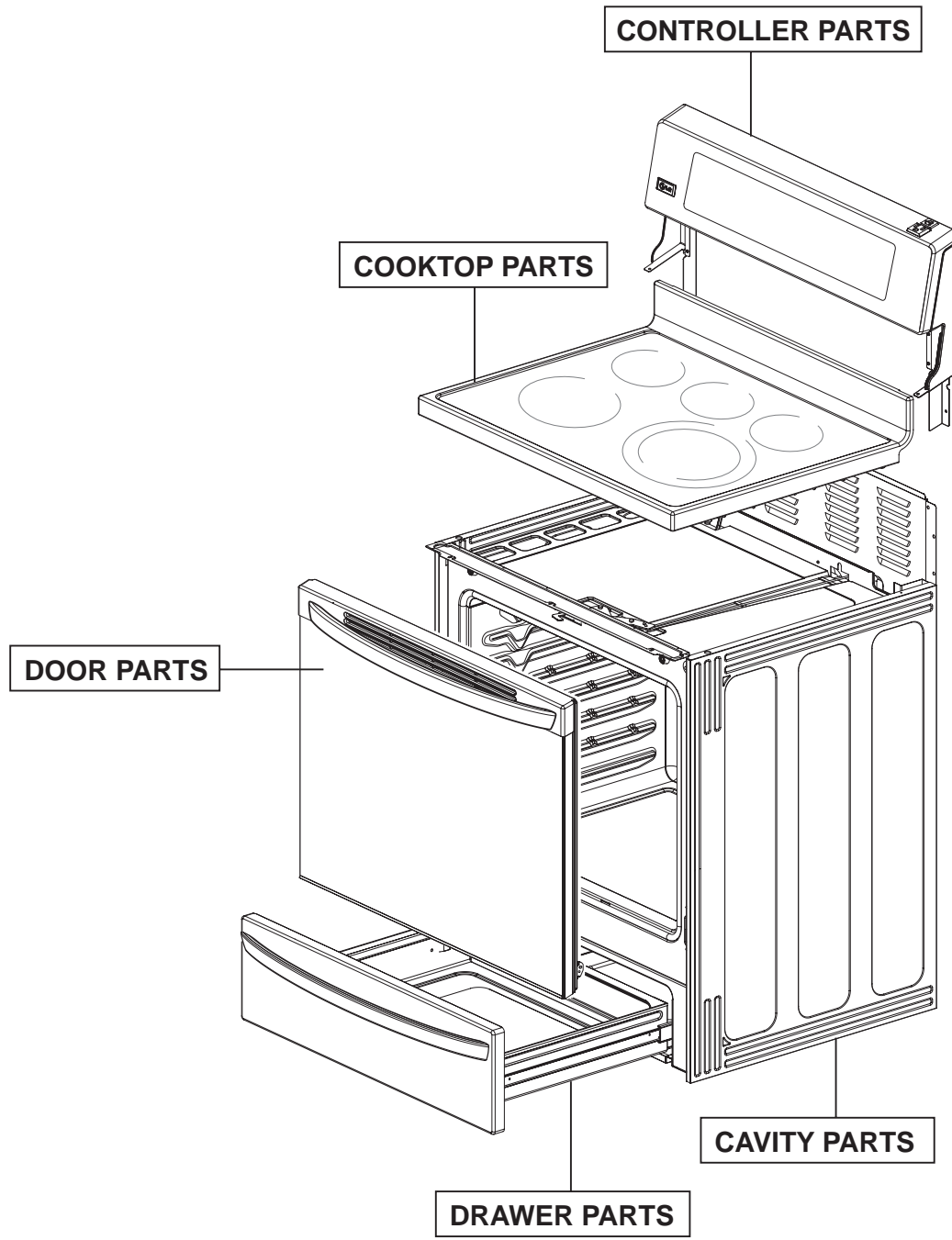

# DOOR PARTS (I)

For Model: LSC5683WW  
LSC5683WB

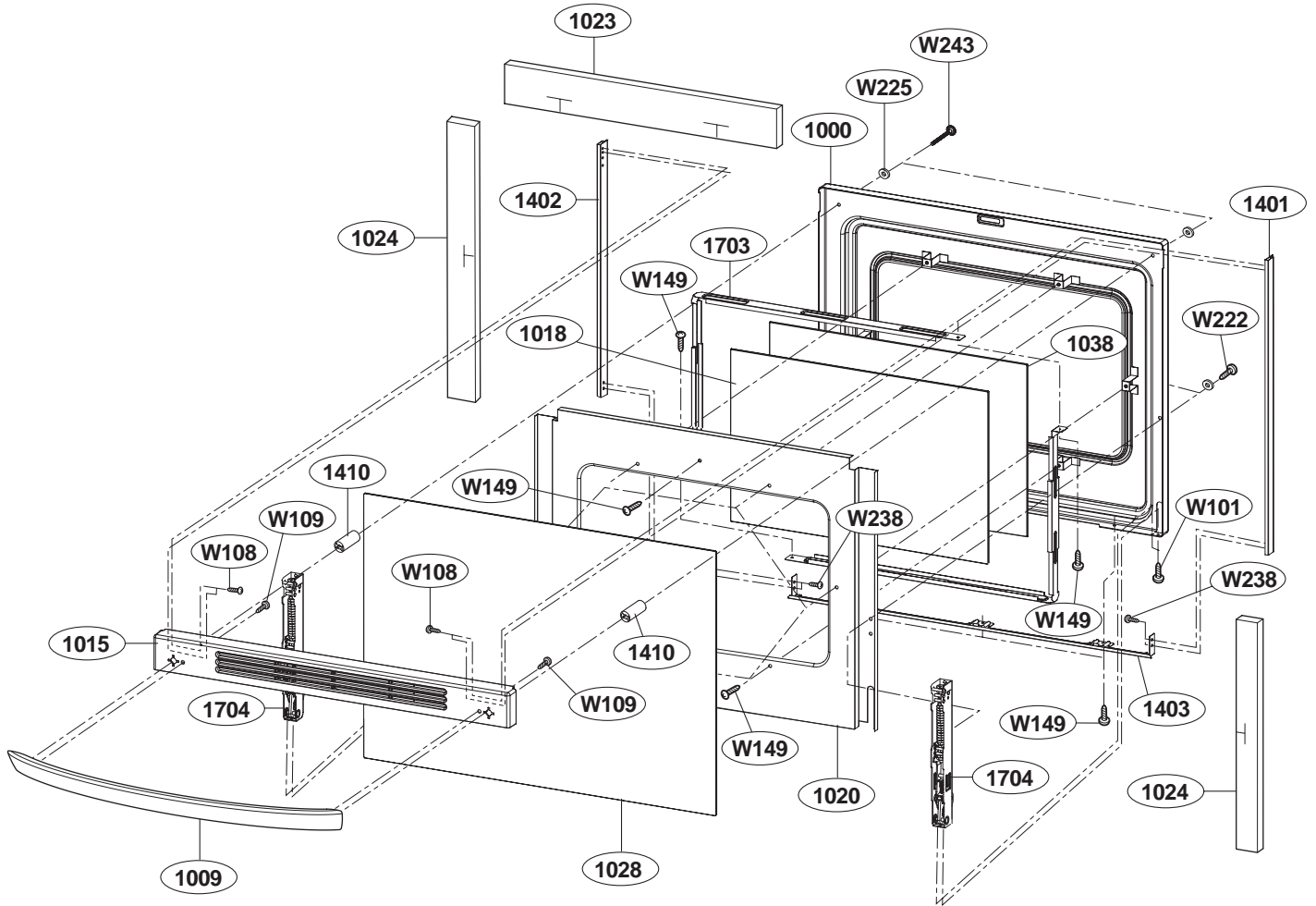

# CONTROLLER PARTS

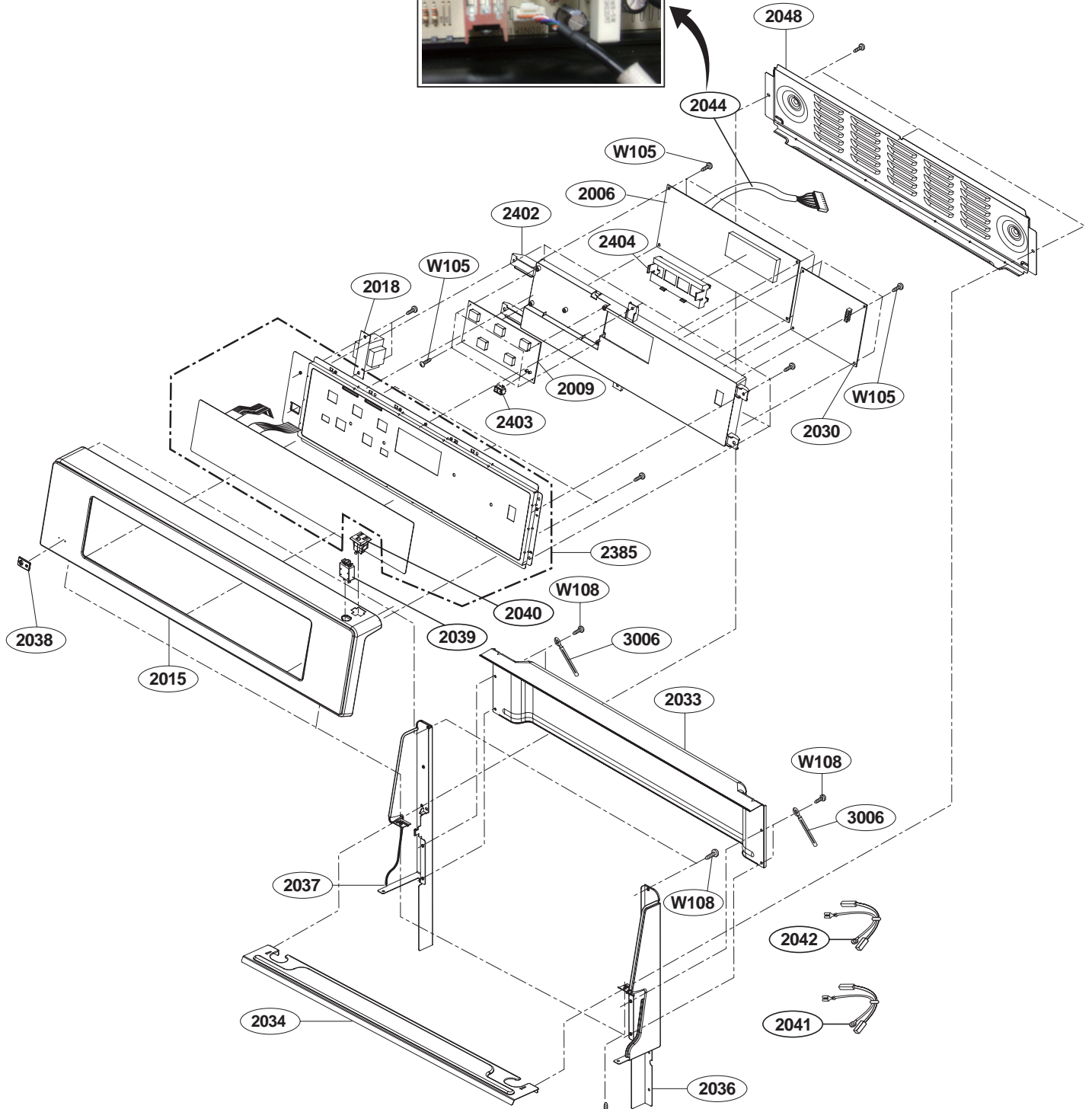
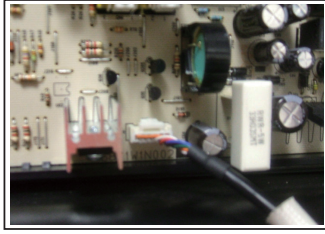

For Model  
LSC5683WB W215

For Model  
LSC5683WW W108  
LSC5683WS

# COOKTOP PARTS

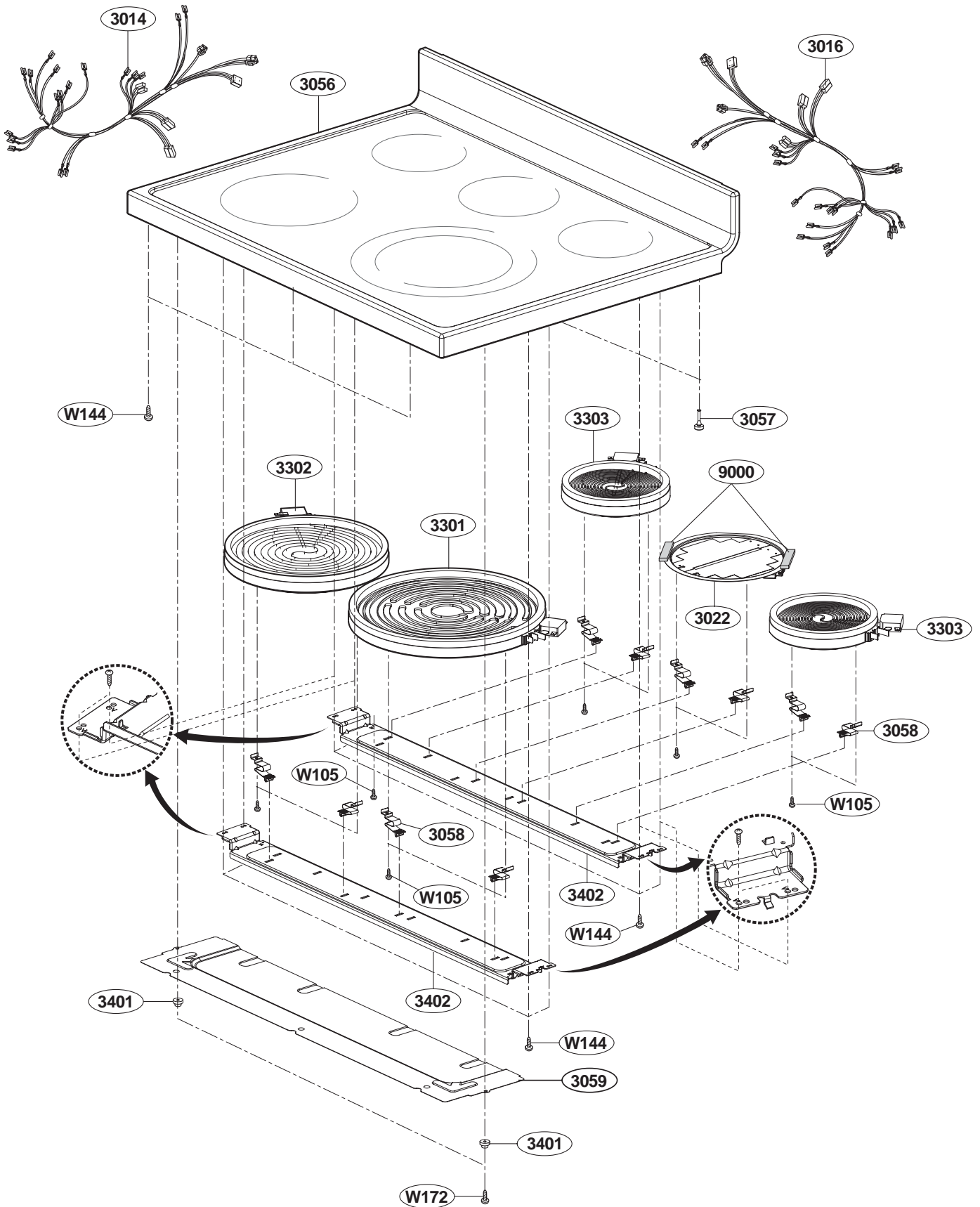

# DRAWER PARTS (I)

For Model: LSC5683WW  
LSC5683WB

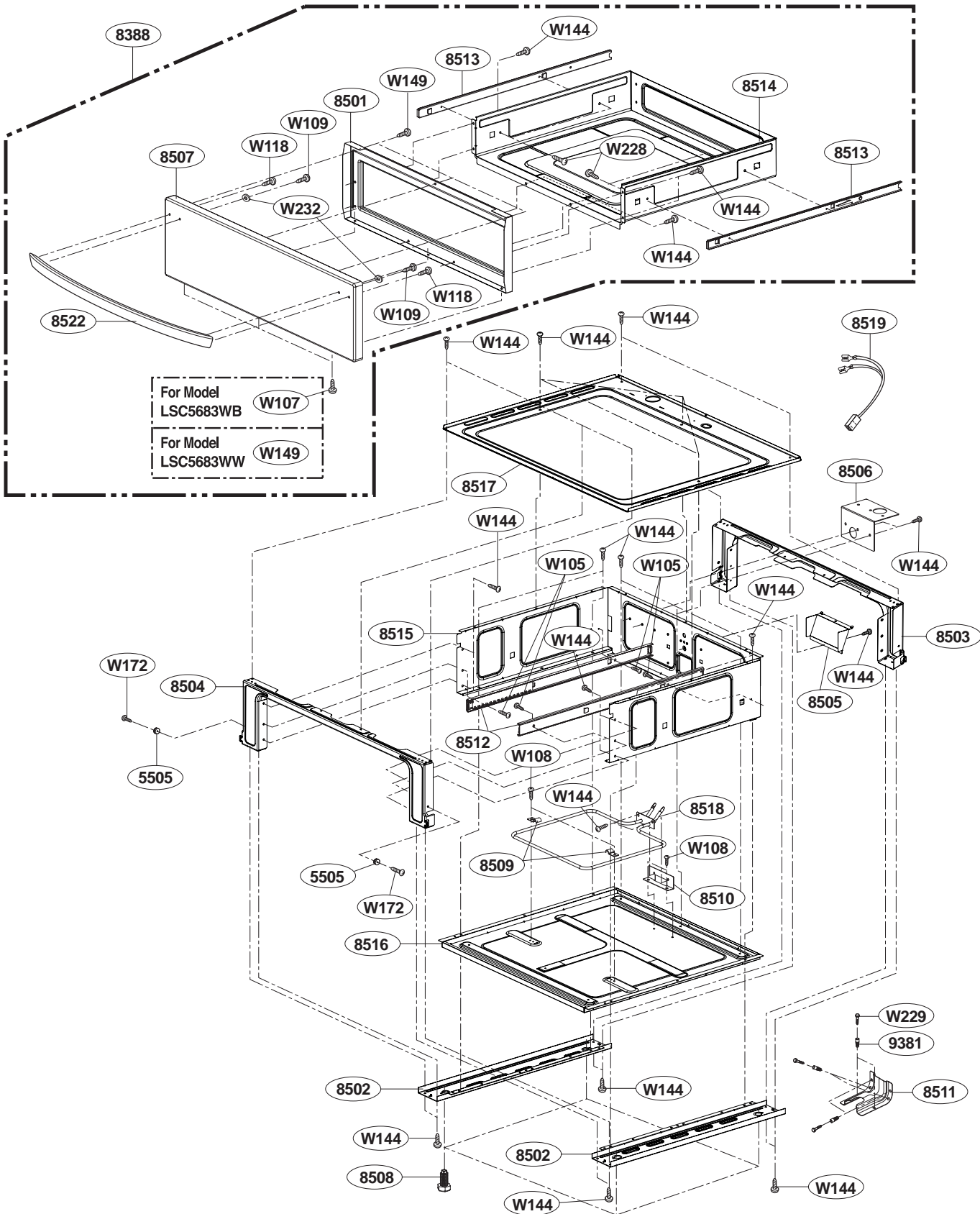

# CAVITY PARTS

