



Internal Use Only

Website <http://biz.lgservice.com>



30" ELECTRIC CONVECTION BUILT-IN OVEN **SERVICE MANUAL**

MODEL: LSWS305ST

CAUTION

BEFORE SERVICING THE UNIT, READ THE SAFETY PRECAUTIONS IN THIS MANUAL.

P/NO : MFL37118308

March, 2010
Printed in Korea

FORWARD

This LG Service Manual, “30” Electric Built-in Oven”, provides the technician with information on the operation and service of the Electric Built-in Oven. It is to be used as a training Service Manual. For specific information on the model being serviced, refer to the “Owner’s Manual” or “Tech Sheet” provided with the electric oven.

SAFETY PRECAUTIONS

- Repairs of the appliance should be carried out by a licensed technician only. Incorrect repairs may result in dangerous situations. If you need repairs, contact an LG Service Center or your dealer.
- If the power cord is defective, it must be replaced by a qualified service agent with a UL listed range cord.
- Electrical leads and cables should not be allowed to touch the oven.
- Rating plate is located on the bracket below the control panel.
- The power supply of the appliance should be turned off when it is being repaired.

WARNING

- **DISCONNECT power supply cord from the outlet before servicing.**
- **Replace all panels and parts before operating.**
- **RECONNECT all grounding devices.**
 - Failure to do so can result in severe personal injury, death or electrical shock.
- **DO NOT Touch when the oven operates.**
 - The interior parts will be very hot.

LG Electronics assumes no responsibility for any repairs made on our products by anyone other than Authorized Service Technicians.

TABLE OF CONTENTS

	(PAGE)
GENERAL	1-1 ~ 1-6
• Read all instructions before use	1-1 ~ 1-4
• Model & Serial number label and tech sheet locations	1-5
• Specifications	1-6
USING YOUR OVEN	2-1 ~ 2-5
• General information	2-1
• Control panel feature	2-2 ~ 2-5
- Setting the initial control	
- Start, clear/off	
- Oven light	
- Timer	
- Control lockout	
- Set up: 8 different category	
1) Language selection	
2) Temperature selection unit	
3) Display brightness	
4) Sound volume Loud/Normal/Mute	
5) Convection auto conversion	
6) Temperature adjustment	
7) Clock time	
8) Reset	
- Bake	
- Timed cook, Delayed timed cook	
- Broil	
- Roast	
- Convection bake	
- Crisp convection	
- Convection roast	
- Recipe bank	
- Proof/Warm	
- Healthier roast	
- My menu	
- Option	
- Self clean	
DISASSEMBLY INSTRUCTIONS	3-1 ~ 3-3
• Component Locations.....	3-1
DISASSEMBLY INSTRUCTIONS	3-2 ~ 3-3
• Replacing the control panel and related components	3-2~3-3
- Removing the Low Voltage Transformer (controller).....	3-2
- Removing the Relay PCB.....	3-3
- Removing the door lock assembly.....	3-3
- Removing the Low Voltage Transformer (halogen lamp).....	3-3
- Removing the Serge filter	3-3
DISASSEMBLY INSTRUCTIONS	3-4 ~ 3-5
• Replacing oven cavity components	3-4 ~ 3-5
- Removing the Broil element	3-4
- Removing the Convection element.....	3-4
- Removing the Blade fan	3-5
- Removing the Halogen lamp & socket assembly	3-5
• Replacing other electrical components.....	3-6 ~ 3-9

- Removing the Vent motor3-6
- Removing the Thermal limiter3-7
- Removing the Door switch 3-7
- Removing the Thermal limiter (Double Line Break)3-8
- Removing the Convection motor assembly3-8
- Removing the Hidden bake element.....3-8 ~ 3-9

DISASSEMBLY INSTRUCTIONS3-10 ~ 3-13

- Removing & Reinstalling the lift-off oven door3-10
- Removing the oven door handle & glass.....3-11 ~ 3-12
- Removing the oven door gasket.....3-13

COMPONENT TEST 4-1 ~ 4-4

- Convection motor.....4-1
- Door locking motor.....4-2
- Door locking micro switch.....4-2
- Low Voltage Transformer - Controller4-2
- Low Voltage Transformer - Halogen lamp4-2
- Oven Thermistor.....4-3
- Door switch.....4-3
- Oven lamp4-3
- Broil Element.....4-4
- Bake Element.....4-4
- Convection element4-4
- Vent motor4-4

DIAGNOSIS THROUGH SCHEMATIC 5-1

HOW TO ENTER THE TEST MODE 5-2

SAFETY CAUTION & ERROR CODE SUMMARY..... 5-3

CHECKING FLOW CHART BY FAILURE MODE..... 5-3 ~ 5-18

- Dead.....5-4 ~ 5-8
- Oven does not heat (including F-9 error)5-9 ~ 5-12
- Not operating Key (including F-3 error).....5-13
- Lock system failure (including F-10 error).....5-14 ~ 5-15
- Oven Thermistor failed (including F-1, F-2 error).....5-16
- Oven too hot (including F-6 error).....5-17
- Communication error → F-10 error.....5-18

SCHEMATIC DIAGRAM 6-1

- Strip circuits 6-2 ~ 6-5

EXPLODED VIEW 7-1 ~ 7-6

REPLACEMENT PARTS LIST 8-1 ~ 8-3

GENERAL

READ ALL INSTRUCTIONS BEFORE USE

Read and follow all instructions before using your oven to prevent the risk of fire, electric shock, injury to person, or damage when using the range. This guide don't cover all possible conditions that may occur. For further assistance contact your service agent or manufacturer.



This is the safety alert symbol. This symbol alerts you to potential hazards that can kill or hurt you and others. All safety messages will follow the safety alert symbol and either the word "WARNING" or "CAUTION". These word means :



WARNING

This symbol will alert you to hazards or unsafe practices which could cause serious bodily harm or death.



CAUTION

This symbol will alert you to hazards or unsafe practices which could cause bodily injury or property damage.



WARNING

- **NEVER use your appliance for warming or heating the room.**
- **DO NOT use water on grease fires.**
 - Turn off the oven to avoid spreading the flames. Smother the fire by closing the oven door or use dry chemical, baking soda, or foam-type extinguishers.
- **Use only dry pot holders.**
 - Moist or damp pot holders on hot surfaces may result in burns from steam. Do not let the pot holder touch hot heating elements. Do not use a towel or other bulky cloth.
- **Storage in or on appliance.**
 - Flammable materials should not be stored in an oven or near surface elements.
- **Wear proper apparel.**
 - Loose-fitting or hanging garments should never be worn while using the appliance.
- **DO NOT place aluminum foil directly on the oven bottom.**
- **Children should be kept away from the oven.**
 - Accessible parts may become hot when the broil is use.
- **DISCONNECT power supply cord from the outlet before servicing.**
- **Replace all panels and parts before operating.**
- **RECONNECT all grounding devices.**
 - Failure to do so can result in severe personal injury, death or electrical shock.
- **DO NOT Touch when the oven operates.**
 - The interior parts will be very hot.
- **ELECTRIC SHOCK HAZARD**
 - Unit must be disconnected from electrical outlet when making repairs, replacements, adjustments. Replace all panels before operating oven. Failure to do so can result in death or electrical shock.



CAUTION

- **DO NOT leave children alone.**
 - Children should not be left alone or unattended in area where appliance is in use.
 - Children should never be allowed to sit or stand on any part of the appliance.
- **DO NOT leave small children unattended near the appliance.**
 - During the self-cleaning cycle, the outside of the oven can become very hot to touch.
- **Be careful when you work on the electric oven handling the sheet metal part.**
 - Sharp edge may be present and you can cut yourself.
- **Be careful not to bend the fan blade.**
- **The door is very heavy. Be careful when removing and lifting door. Do not lift the door by the handle.**

GENERAL

READ ALL INSTRUCTIONS BEFORE USE

SAFETY PRECAUTIONS

- Be certain your appliance is properly installed and grounded by a qualified technician.
- Do not repair or replace any part of the appliance unless specifically recommended in the manual.
- All other servicing should be referred to a qualified technician.
- Always disconnect power to appliance before servicing by unplugging, removing the fuse or switching off the circuit breaker.
- **DO NOT TOUCH HEATING ELEMENTS OR INTERIOR SURFACES OF OVEN.**
Heating elements may be hot even though they are dark in color. Interior surfaces of an oven become hot enough to cause burns. During and after use, do not touch or let clothing or other flammable materials contact heating elements or interior surfaces of oven until they have had sufficient time to cool. Other surfaces of the appliance may become hot enough to cause burns. Among these surfaces are oven vent openings and surfaces near these openings, oven doors, and windows of oven doors.
- **Use Care When Opening Door.**
Let hot air or steam escape before you remove or replace food in the oven
- **Do Not Heat Unopened Food Containers.**
Build-up of pressure may cause container to burst and result in injury.

- **Keep Oven Vent Ducts Unobstructed.**

The oven vent could become hot during oven use. Never block this vent and never place plastic or heat-sensitive items on or near the vent.

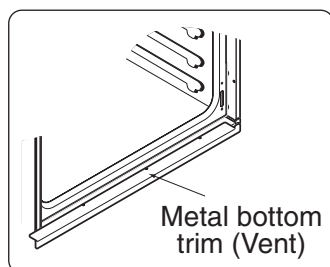

NOTE:

For proper operation vent trim must be installed.

- **Be certain all packing materials are removed from the appliance before operating.**
Keep plastics, clothes, and paper away from parts of the appliance that may become hot.
- **DO NOT force the door open.**
This can damage the automatic door locking system. Use care when opening the oven door after the self-cleaning cycle. Stand to the side of the oven when opening the door to allow hot air or steam to escape. The oven may still be VERY HOT.
- **DO NOT use a steel-wool pad.**
It will SCRATCH the surface.
- **DO NOT use harsh etching, abrasive cleaners or sharp metal scrapers to clean the oven door glass since they can scratch the surface.**
It may result in shattering of the glass.
- **Be careful when removing and lifting the door.**
- **DO NOT lift the door by the handle.**
The door is very heavy.
- **DO NOT step or sit on oven door.**
Be sure to follow proper installation instructions.

ELECTRICAL SAFETY

- **Protective Liners.** Do not use aluminum foil or any other material to line the oven bottoms. Improper installation of these liners may result in a risk of electric shock or fire.
- **Do Not** allow aluminum foil or meat probe to contact heating elements.

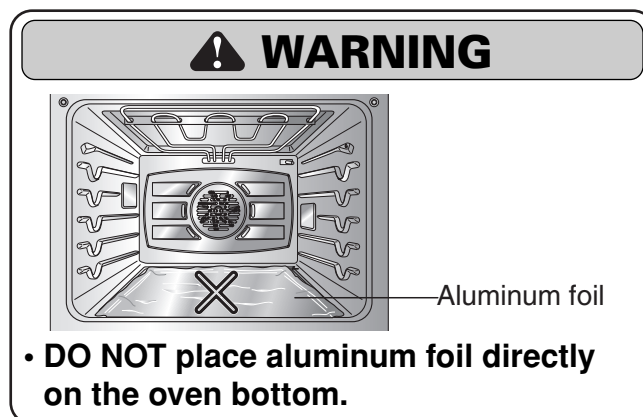

GENERAL

READ ALL INSTRUCTIONS BEFORE USE

- **Before replacing your oven light bulb, switch off the electrical power to the oven at the main fuse or circuit breaker panel.**
Failure to do so can result in severe personal injury, death, or electrical shock.
- **DO NOT line the oven walls, racks, bottom, or any other part of the oven with aluminum foil or any other material.**
Doing so will disrupt heat distribution, produce poor baking results and cause permanent damage to the oven interior (aluminum foil will melt to the interior surface of the oven.)

SAFETY DURING USE

- **Oven Racks.** Always place oven racks in desired position while oven is cool.
- **Always use pot holders or oven mitts when removing food from the oven.**
You can be burned because cookware and plates will be hot.
- **Use caution with the TIMED BAKE or DELAYED TIMED BAKE features.** Use the automatic timer when cooking cured or frozen meats and most fruits and vegetables. Foods that can easily spoil, such as milk, eggs, fish, meat or poultry, should be chilled in the refrigerator first. Even when chilled, they should not stand in the oven for more than 1 hour before cooking begins, and should be removed promptly when cooking is completed.
Eating spoiled food can result in sickness from food poisoning.
- **Should an oven fire occur, leave the oven door closed and turn the oven off. If the fire continues, throw baking soda on the fire or use a fire extinguisher.**
- **DO NOT put water or flour on the fire.**
Flour may be explosive and water can cause a grease fire to spread and cause personal injury.
- **DO NOT use the broiler pan without the grid. DO NOT cover the grid with aluminum foil.**

CHILD SAFETY

WARNING

- **Children should be kept away from the oven.**
- **Accessory parts will become hot when the broiler is in use.**

CAUTION

- **Children should not be left alone or unattended in area where appliance is in use. Children should never be allowed to sit or stand on any part of the appliance.**

CAUTION

- **DO NOT leave small children unattended near the appliance.**
During the self-cleaning cycle, the outside of the oven can become very hot to the touch.

GENERAL

READ ALL INSTRUCTIONS BEFORE USE

SAFETY WHEN CLEANING

- **Do Not Clean Door Gasket.** The door gasket is essential for a good seal. Care should be taken not to rub, damage, or move the gasket.
- **Do Not Use Oven Cleaners.** No commercial oven cleaner or oven liner protective coating of any kind should be used in or around any part of the oven.
- **Before self cleaning the oven.** Remove broiler pan, all oven racks, meat probe and any other utensils from the oven cavity.
- **Never keep pet birds in the kitchen.** The health of birds is extremely sensitive to the fumes released during an oven self-clean cycle. Fumes may be harmful or fatal to birds. Move birds to well-ventilated room.
- **Important Instruction.** In the event the self clean error code **F** is displayed, and error melody sounds, the oven is malfunctioning in the self clean mode. Switch off the electrical power to the main fuse or breaker and have serviced by a qualified technician.
- **Make sure oven lights are cool before cleaning.**
- **DO NOT block the oven vent during operation.**
This can damage the electric parts of the oven. Air must be able to move freely. The metal bottom trim (vent) should be properly assembled on the front bottom of oven before installing the oven door.

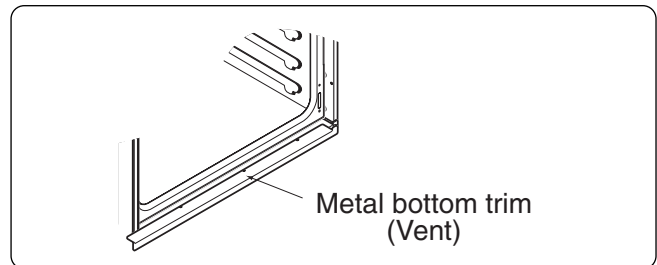

GENERAL

MODEL & SERIAL NUMBER LABEL AND TECH SHEET LOCATION

The Model/Serial Number label and Tech Sheet locations are shown below.

Model & Serial
Number Location



Tech Sheet Location

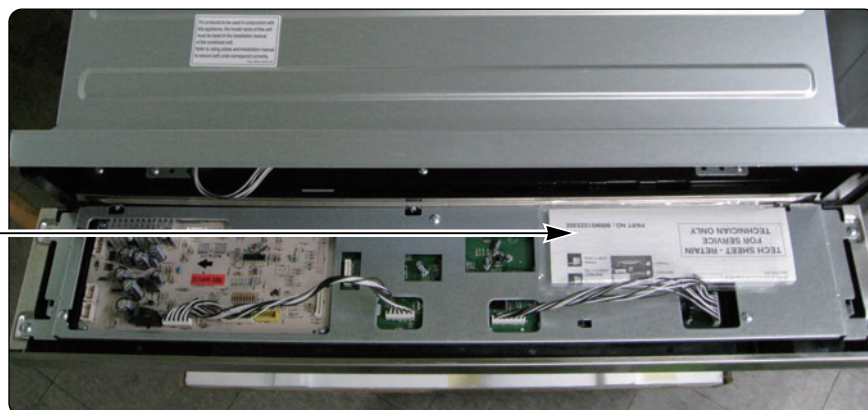

GENERAL

SPECIFICATIONS

Product Specification List				
No	Items	Specifications	Remarks	
1	Model name	LSWS305ST Built-in Single wall oven	North American market	
2	Rating power source	240 V~ 60 Hz	Single phase & 4-wires	
3	Heat source	Sheath heater & Carbon heater		
4	Max power	4.1 KW	120/208V : 3.0 KW	
5	Max input current	17.3 A		
6	Rating power consumption & Rating input current	Bake	2,500W / 10.4A	
		Broil	4,000W / 16.7A	
		Convection	2,500W /10.4A	
		Lamp	12V/10W/0.8A	Front ceiling area
		Lamp	(12V/10W/0.8A×2)	Left & right sides
		Cooling motor	120V/41W/0.34A	
		Convection motor	120V/42W/0.65A	
		Locking motor	120V/3.5W/0.03A	
7	Efficiency	Higher than 80%		
8	Control style	Touch screen, glass touch & Micom		
9	Display	White LCD	Liquid Crystal Display	
10	Power control range	170~550°F (77~288°C)	At bake mode	
11	Capacity (Overall, W×H×D)	4.7 cu.ft (622×449×474)	24 1/2×17 11/16×18 5/8	
12	Capacity (Usable)	3.2 cu.ft (601×345×436)	23 5/8×13 9/16×17 3/16	
13	Cut out size (W×H×D)	724×735×596	28 1/2×28 15/16×23 1/2	
14	Unit Dimension	755×745×619	29 3/4×29 5/16×24 3/8	
15	Net Weight	71 Kg	154 lbs	
16	Packing size	838×864×762	33×34×30	
17	Packing weight	81 Kg	187 lbs	
18	Stack height	3 levels		

USING YOUR OVEN

GENERAL INFORMATION

Rating Label

Model numbers are recorded on the rating label. Rating label is located on the lower left bottom area of the controller. It can be seen by opening the door. Before ordering parts, write down the correct model and serial number from rating label. This avoids incorrect shipments and delays. Please refer to parts reference material when ordering replacement parts.

Functional Operation

Bake Mode

Top and hidden bottom elements operate during bake. Bake can be used to cook foods which are normally baked. Oven must be preheated. Convection fan and heater operates during the Preheat cycle of Bake mode.

Broil Mode

Top element operates during broil. Broil can be used to cook foods which are normally broiled. Preheating is not required when using broil. All foods should be turned at least once except fish, which does not need to be turned.

Convection Bake / Roast Mode

Upper element, lower element, Rear element and fan operate during convection bake. Convection bake should be used for cooking casseroles and roasting meats. Oven should be preheated for best results when using convection bake. Pans do not need to be staggered. Cooks approximately 25% quicker than bake.

Cooking Guide

Refer to the owners manual for recommendations of times and temperatures. Times, rack position, and temperatures may vary depending on conditions and food type. For best results, always check food at minimum time. When roasting, choose rack position based on size of food item.

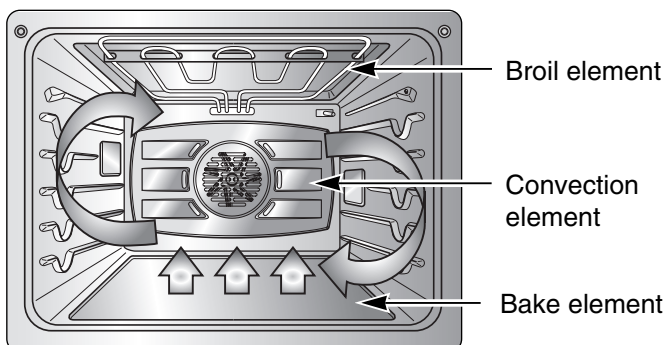

USING YOUR OVEN

CONTROL PANEL FEATURES

READ THE INSTRUCTIONS CAREFULLY BEFORE USING THE OVEN. For satisfactory use of your oven, become familiar with the various features and functions of the oven as described below.

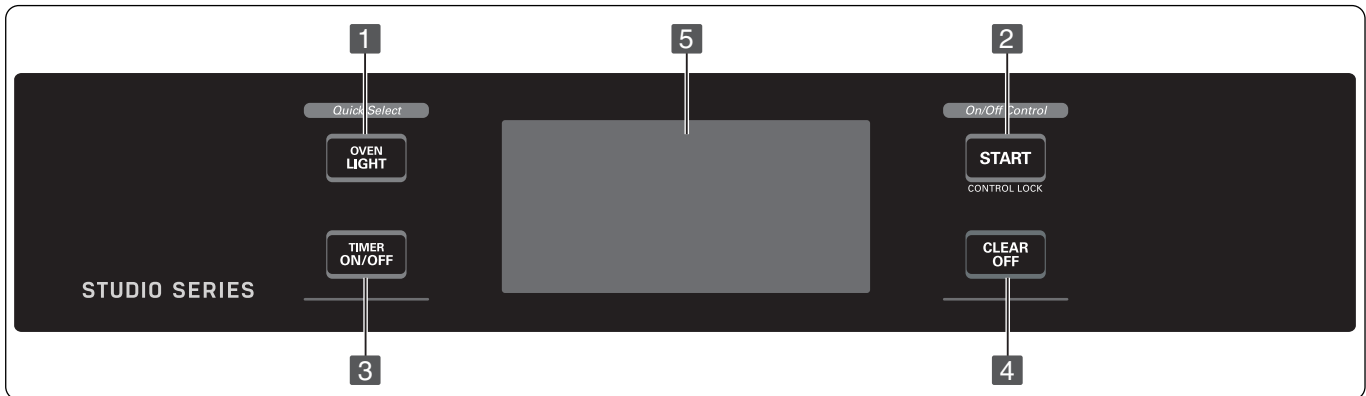

1. **OVEN LIGHT:** Use to turn the oven lights on and off.
2. **START:** Use to start all oven features. Activate the CONTROL LOCK for 4 seconds holding.
3. **TIMER ON/OFF:** Use to set or cancel the timer.
4. **CLEAR/OFF:** Use to stop cooking or cancel the setting of the oven.
5. **Touch Screen:** Show the time of day, main menu, and oven temperature; whether the oven is the bake, broil or self-cleaning mode; and the times set for the timer or automatic oven operations. The display panel will go into a "sleep" mode if no activity. Touch the display once to activate and again to make your selection.
6. **Bake:** Use to select the normal bake mode.
7. **Broil:** Use to set the variable broil mode.
8. **Roast:** Use to select the normal roast mode.
9. **Conv. Bake:** Use to select the convection bake mode.
10. **Crisp Conv.:** Use to select the crisp convection mode.
11. **Conv. Roast:** Use to select the convection roast mode.
12. **Recipe Bank:** Use to recall the recipe category of gourmet food.
13. **Proof/Warm:** Use to proof bread / Use to hold food warm.
14. **Healthier Roast:** Use to select the healthier roast mode.
15. **My Menu:** Use to save or recall the favorite 10 cook mode.
16. **Set up:** Use to change the special settings.
17. **Self Clean:** Use to select the self-cleaning cycle.

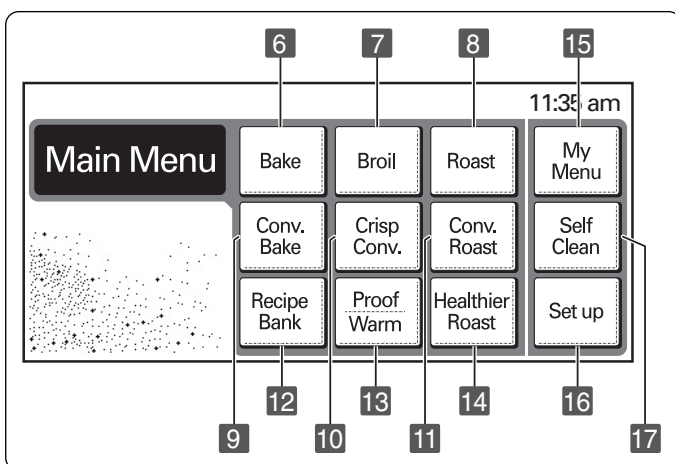

NOTE:

- Press CLEAR/OFF pad. Allow the oven to cool for one hour. Put back into operation.
- **If the function error code repeats, disconnect the power to the oven and call for service.**
- If the oven was set for a timed oven operation and a power failure occurred, the clock and all programmed functions must be reset.
- The time of day will flash and PF will appear in the display when there has been a power failure.

USING YOUR OVEN

1. SETTING THE INITIAL CONTROL

- 1) LG logo display 8 seconds. - Initial display (Power Failure or Reset)
First, Select Language, and set clock time, and then the oven can be used.
If power failure occurs, the oven will remember your language selection however you will still need to set the time of day.



- 2) Key Function, General Usage While selecting any function, an appropriate key input sequence must be followed. In case of an inappropriate input sequence the key error beeps sound. Numeric key are used while entering data (temperature and time) for cooking.

2. START, CLEAR/OFF

- 1) START key to start oven
- 2) CLEAR/OFF key to cancel a program during cooking or erase during programming.

3. OVEN LIGHT

- 1) Requirement: The Oven Light is used to turn on or off the oven light.
- 2) Key Input Process: Oven Light-ON/OFF toggle operation.
If the Oven Light is on by pressing oven light key, the light is on even if the door is closed. Oven light key can be operated while door opens.
- 3) Exception: Oven light will not operate during a self clean cycle. Once self clean is complete the oven light will not operate until oven cools down.

4. TIMER

- 1) Requirement: The timer works like an alarm clock that will continuously beep until turned off. The oven can fully operate during the use of the timer.
- Setting Limit : 11Hour : 59Min

- 2) Min and Sec Setting;

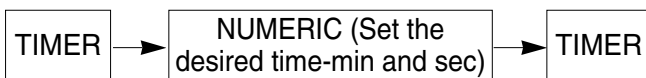

- 3) Hour and Min setting

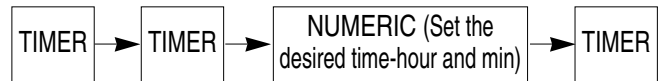

- 4) When the set time has elapsed, "Timer End" is displayed. Timer alarm melody will sound every 15 seconds until TIMER is pressed. Press timer key in order to cancel running timer or clear timer end alarm. The time less than 1 hour is displayed in min and sec on timer operation.

5. CONTROL LOCKOUT

- 1) The START key controls the Control Lock feature. The Control Lock feature automatically locks most oven controls from being turned ON. It does not disable the timer and the interior oven light. The Control Lock feature will cancel the cooking mode and will lock the oven controls at any time when you activate this feature.
- 2) Key Input Process : START (for 4 seconds)
Lock melody will sound.
- 3) To unlock the control, press START (for 4 seconds)
Unlock melody will sound.

6. SET UP (8 DIFFERENT CATEGORIES)

1) Language Selection

1. Requirement: The scroll display can be shown either in English/Spanish/French.
2. Key Input Process

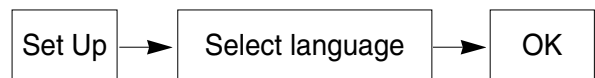

3. CLEAR to reject the change.

2) Temperature Selection unit

1. Requirement: The oven control can be programmed to display temperatures in Fahrenheit or Centigrade. The oven has been preset at the factory to display in Fahrenheit.
2. Key Input Process

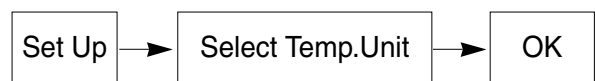

3. CLEAR to reject the change.

USING YOUR OVEN

3) Display brightness

1. Requirement: LCD Display Brightness adjustment
2. Key Input Process

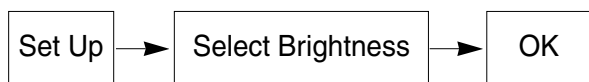

3. CLEAR to reject the change.

4) Sound Volume Loud/Normal/Mute

1. Requirement: When want to reduce or increase the volume.
2. Key Input Process

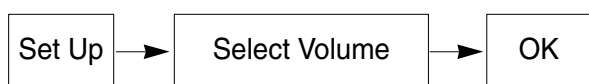

3. CLEAR to reject the change.
4. Exception : Error Alarm, Preheat Alarm, Timer End Alarm – If Mute, Normal Beep Sounds.

5) Convection Auto Conversion

1. Requirement: When using convection, Auto conversion will automatically convert an entered regular baking temperatures to convection baking temperatures.
2. Key Input Process

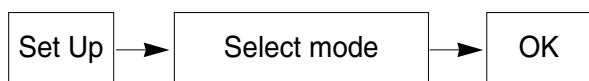

3. CLEAR to reject the change.

6) Temperature Adjustment

1. To change the oven temperature during use follow the steps below.

Fahrenheit : (-)35 ~ (+)35

Centigrade : (-)19 ~ (+)19

2. Key Input Process



3. CLEAR to reject the change.

* **Note:** This adjustment is available for Bake, Roast, Convection Bake, Roast, Crisp Conv. Healthier Roast. Temperature Adjustment can be confirmed by measuring real Oven Cavity Temperature.

7) Clock Time

1. Requirement: The clock key is used to set the clock in idle mode. The clock can be set to 12 or 24 hour format. am and pm can be set in 12 hours. When the oven is initially plugged in, or when the power supply to the oven is interrupted, the clock time is saved in ROM.

2. Key Input Process

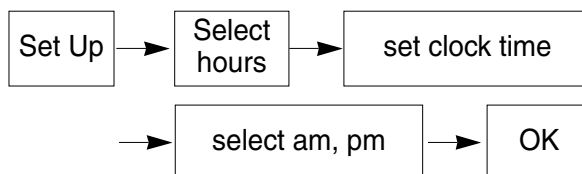

3. CLEAR to cancel the clock setting.

8) Reset

1. Requirement: Setting Value will be default value.
2. Key Input Process

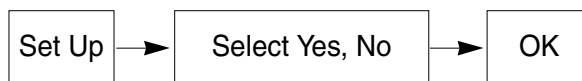

3. CLEAR to reject the change.

7. BAKE



8. TIMED COOK, DELAYED TIMED COOK

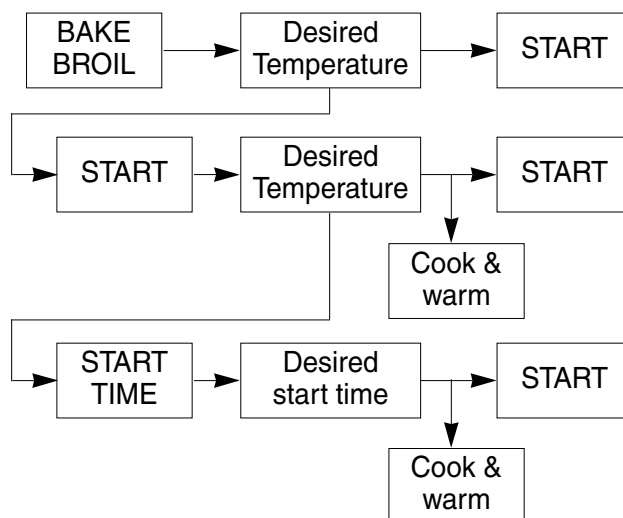

USING YOUR OVEN

9. BROIL

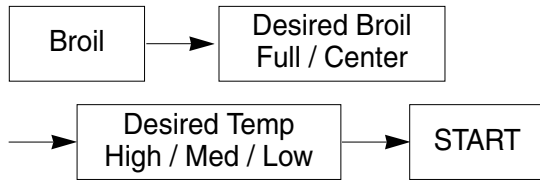

10. ROAST

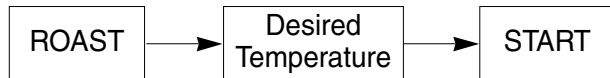

11. CONVECTION BAKE

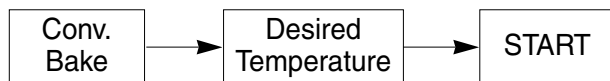

12. CRISP CONVECTION

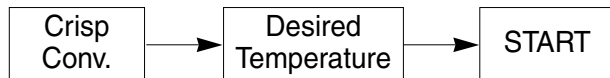

13. CONVECTION ROAST

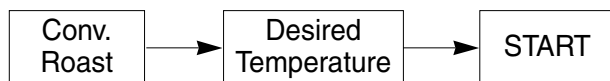

14. RECIPE BANK

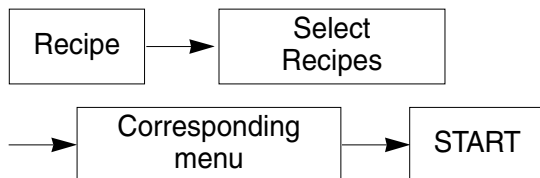

15. PROOF/WARM

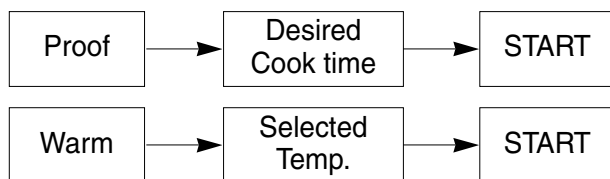

16. HEALTHIER ROAST

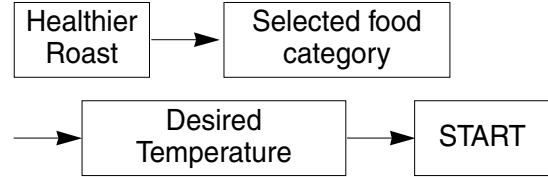

* Note: The meat probe must be used in this feature.
(refer to the HEALTHIER ROASTING CHART.)

17. My MENU

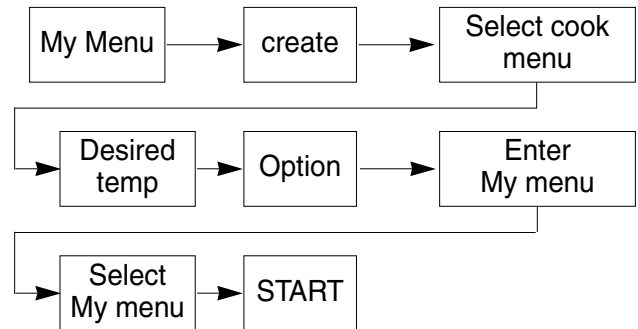

18. OPTION



19. SELF CLEAN

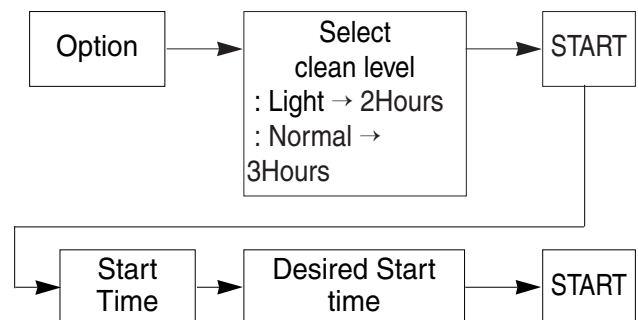

DISASSEMBLY INSTRUCTIONS

This section instructs you on how to service each component inside the oven. The components and their locations are shown below.

COMPONENT LOCATIONS

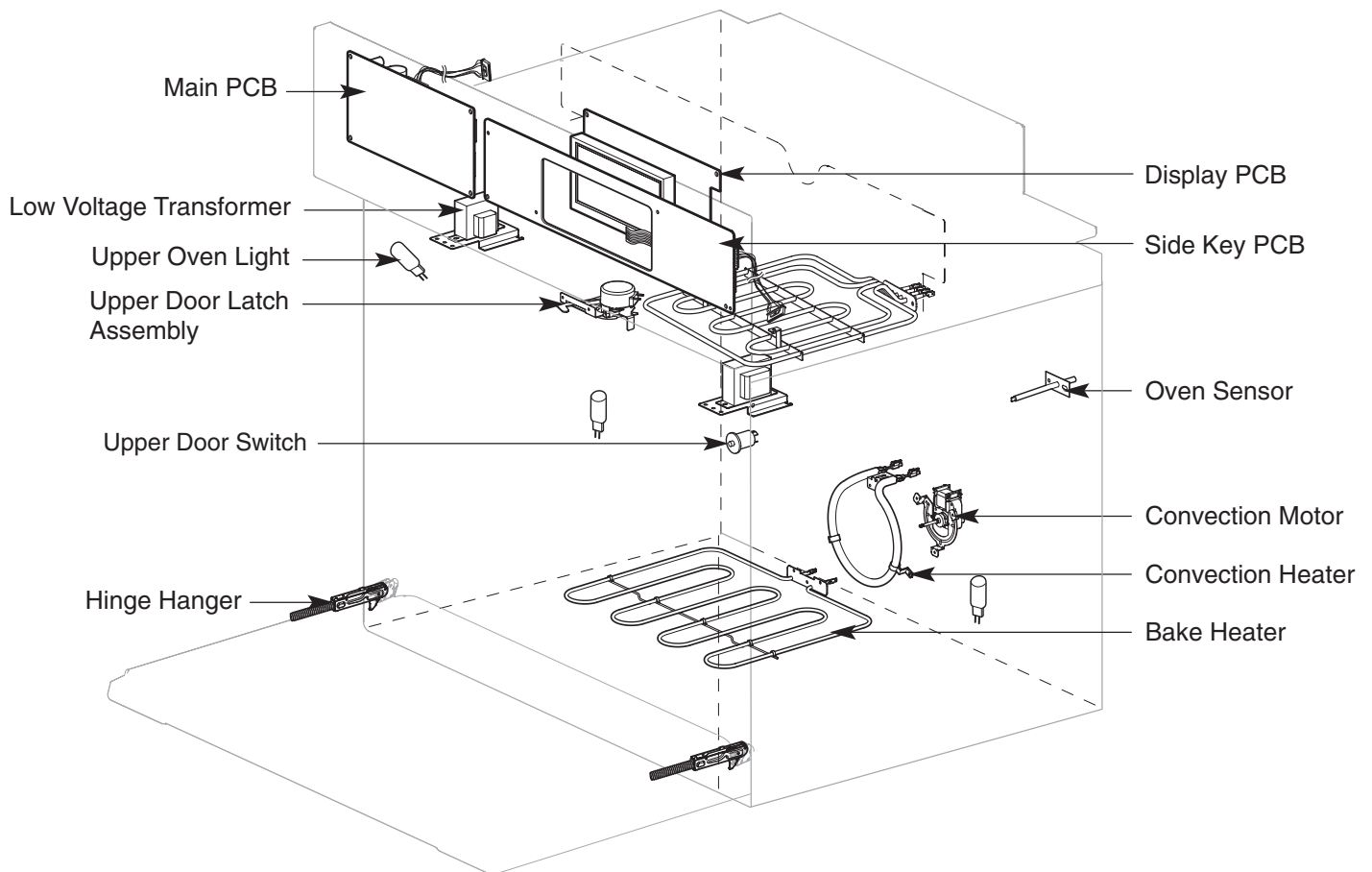

DISASSEMBLY INSTRUCTIONS

REPLACING THE CONTROL PANEL AND RELATED COMPONENTS

⚠ WARNING

• ELECTRIC SHOCK HAZARD

- Unit must be disconnected from electrical outlet when making repairs, replacements, adjustments. Replace all panels before operating oven. Failure to do so can result in death or electrical shock.

⚠ CAUTION

- Be careful when you work on the electric oven handling the sheet metal part.

1. Turn off the electrical supply going to the oven.
2. Open the door assembly.
3. Remove the 3 screws from below the control panel.



4. Close the door assembly.
5. Lift the control panel off from the guide hooks and top trim. Tilt the control panel down. Hinge panel into slots on main body and let control panel rest.

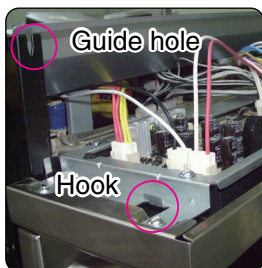

6. Disconnect the 8EA connector from PCB assembly (CN01, CN02, CN03, CN04, CN08, CN11) and separate control panel carefully.

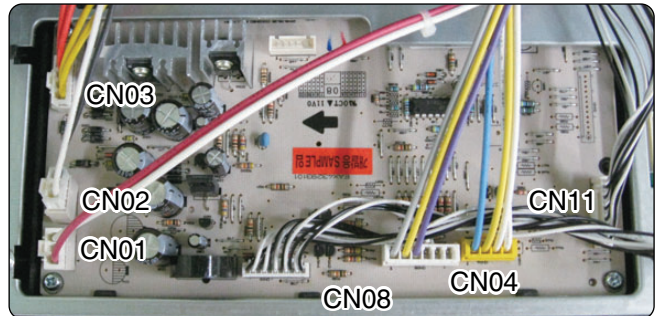

7. You can see the interior of electric parts chamber.

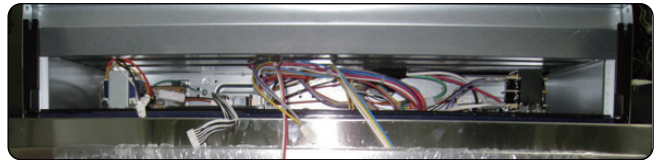

8. To remove the following components follow the sequence below.
Controller LVT, Relay PCB, Door lock motor, Halogen lamp LVT, Surge filter can be serviced without removing the oven.

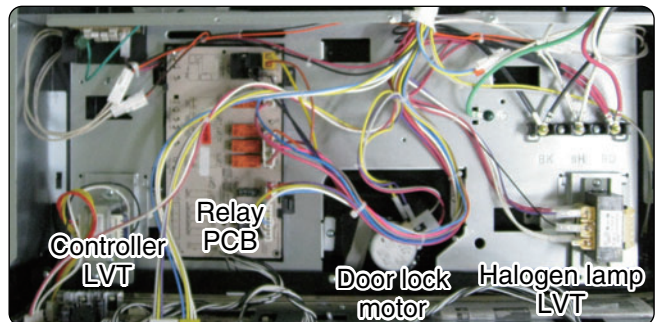

- 1) To remove the PCB Low voltage transformer. Remove the 1 screw.

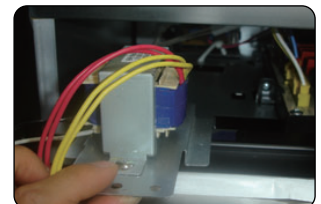
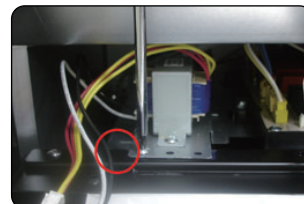

DISASSEMBLY INSTRUCTIONS

- 2) **To remove the Relay PCB**, Remove 1 screw and slide relay PCB out.
Disconnect the 7EA connector from PCB assembly(CN01, CN02, WH, WH, VI, YL, RY19) and separate Relay PCB assembly.

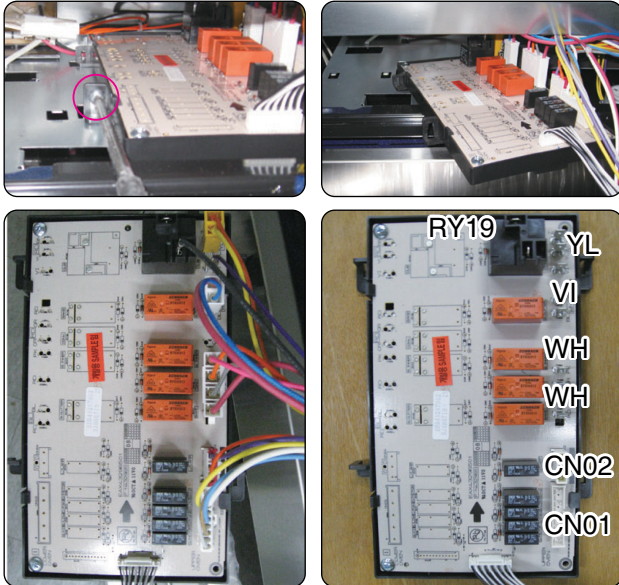

- 3) **To remove the Door lock assembly**, Open the door, and remove the 2 screws located on the front grill. Remove the 2 connectors.

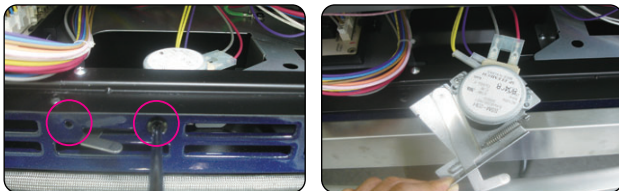

DOOR LOCKING MECHANISM

The door lock assembly is located on top of the oven. The structural elements are as below.

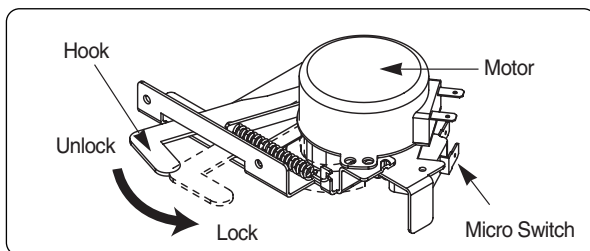

The door lock is controlled by the PCB and is activated when the oven is put into a self clean cycle. The oven will remain locked after a self clean until the temperature fall below 500°F/260°C. If there is a failure of this motor the following steps can be followed to unlock the door manually.

TO UNLOCK THE OVEN DOOR MANUALLY

In case of need, the oven door could be unlocked manually for the service. Follow the steps below.

Unlocking status

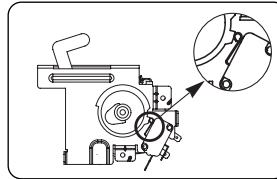

Locking status

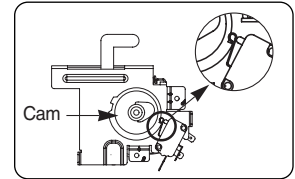

1. Disconnect oven from the power source.
2. Using a L shaped object (close hanger) insert it into the gap between the door and the control panel. Grasp the hook on the motor and pull towards the left. Be careful not to damage the oven.
3. While holding the door latch in the Unlocked position you can now open the door.

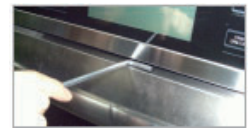

Unlocking tool Door Hook

- Note:** Refer to the service manual for proper replacement of the door lock motor.



- 4) **To remove the Halogen lamp**, remove the 1screw.
Disconnect the 5 connections.

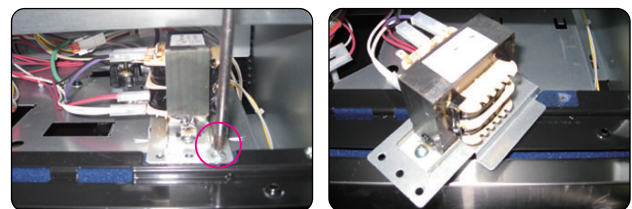

- 5) **To remove the Surge filter**, remove the controller LVT and then remove the 1screws located back plate.
Disconnect the 2 connections.

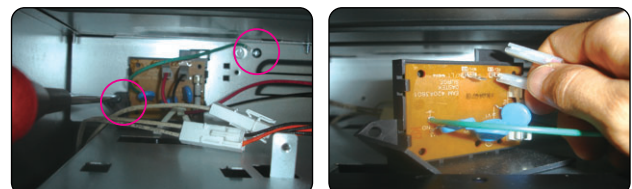

DISASSEMBLY INSTRUCTIONS

REPLACING OVEN CAVITY COMPONENTS

WARNING

• **ELECTRIC SHOCK HAZARD**

- Unit must be disconnected from electrical outlet when making repairs, replacements, adjustments. Replace all panels before operating oven. Failure to do so can result in death or electrical shock.

CAUTION

- **Be careful when you work on the electric oven handling the sheet metal part.**

1. Turn off the electrical supply going to the oven.
2. Remove the door assembly.
3. To remove the following components follow the sequence below.
Broil element, Convection element, Fan blade, Oven thermistor, Halogen lamp can be serviced without removing the oven.

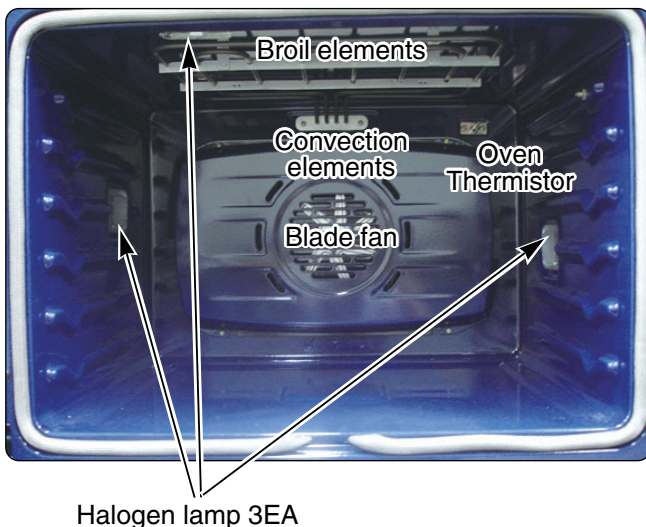

1) To remove the broil element:

- a. Remove the 4 screws from the front and rear brackets.

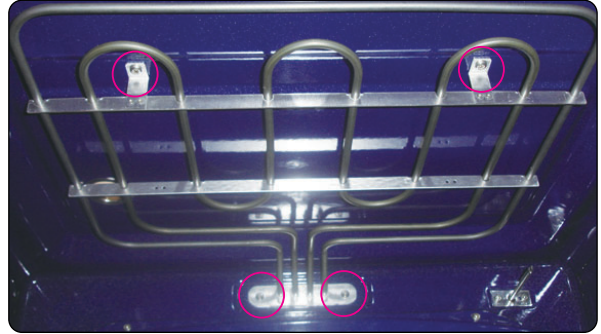

- b. Pull the element forward so that you can access the terminals and disconnect the wires.



2) To remove the convection element:

- a. Remove the 4 screws on the convection fan cover.

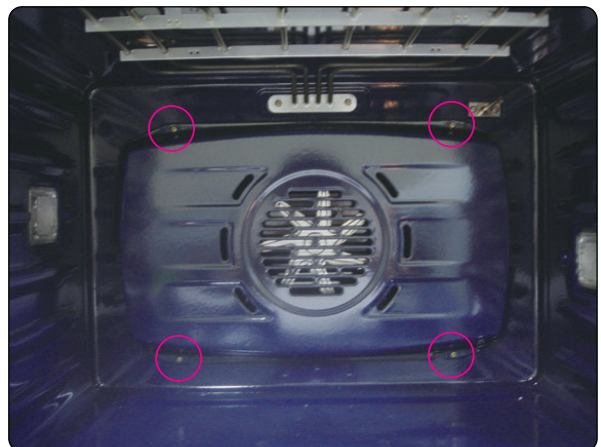

DISASSEMBLY INSTRUCTIONS

- b. Remove the 4 convection element screws.
(The convection element is fragile. Care should be taken to avoid any risk of injury)

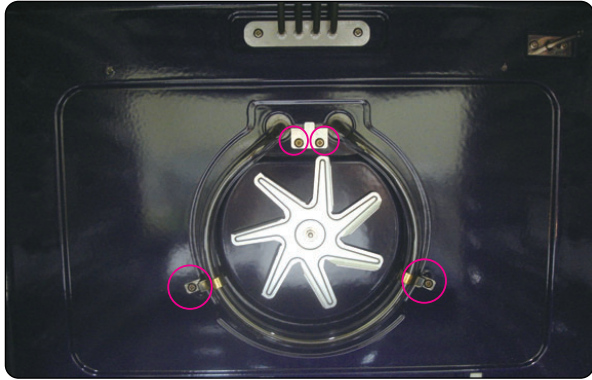

- c. Pull the element forward so that you can access the terminals and disconnect the wires.

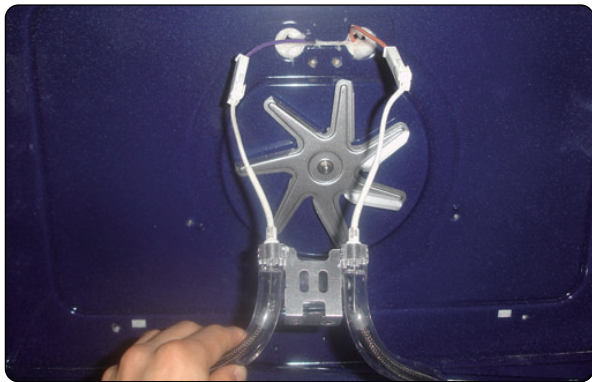

⚠ CAUTION

Be careful not to bend the fan blade.

3) To remove Blade fan(Convection fan)

- a. Remove nut by screwing clockwise.
(be careful fan blade is bent easily)
b. Fan blade can be replaced from inside oven.

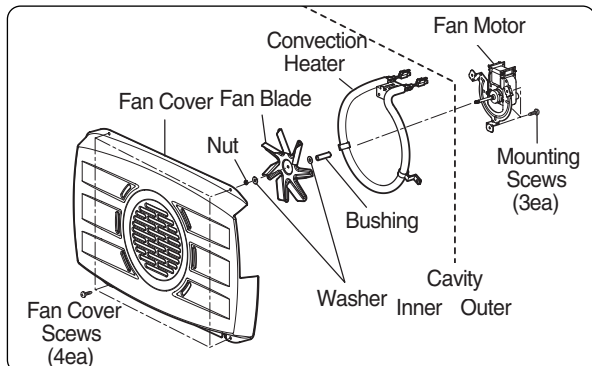

4) To remove the halogen lamp & socket assembly

- a. There are three halogen lamp & socket assembly in the oven cavity.

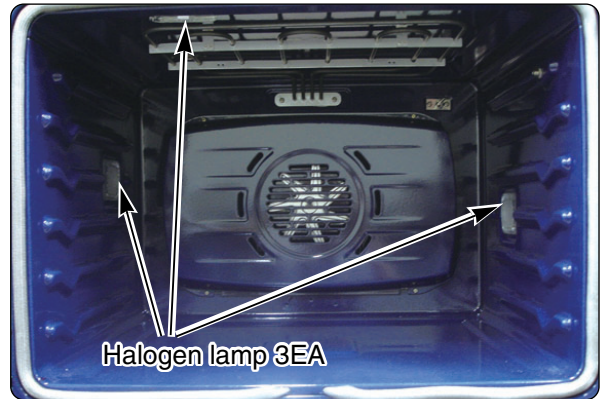

- b. Insert a flat blade screwdriver into the guide hole and pull off.

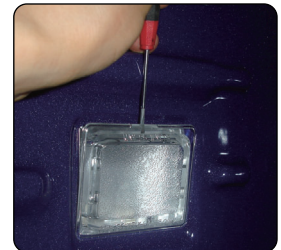

- c. Replace the halogen lamp, then reinstall the glass cover.



* Note :The above instructions can be used for replacing any of the halogen bulbs in either oven.

5) To remove oven temperature sensors,

- Remove the 2 screws from the temperature sensor bracket.
Pull the temperature sensor forward and remove the connector.

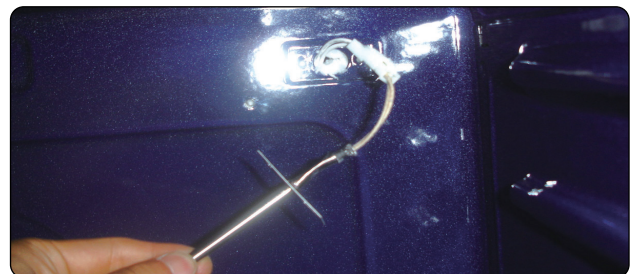
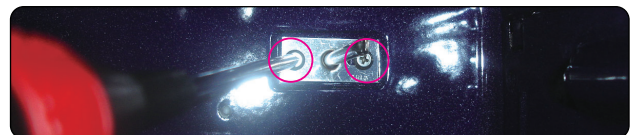

DISASSEMBLY INSTRUCTIONS

REPLACING OTHER ELECTRICAL COMPONENTS

WARNING

• **ELECTRIC SHOCK HAZARD**

- Unit must be disconnected from electrical outlet when making repairs, replacements, adjustments. Replace all panels before operating oven. Failure to do so can result in death or electrical shock.

CAUTION

- **Be careful when you work on the electric oven handling the sheet metal part.**

1. Turn off the electrical supply going to the oven.
2. Pull the oven away from the wall cabinet so that you can access upper panel.
3. Remove the upper panel, there are 3 total pieces (13 screws).

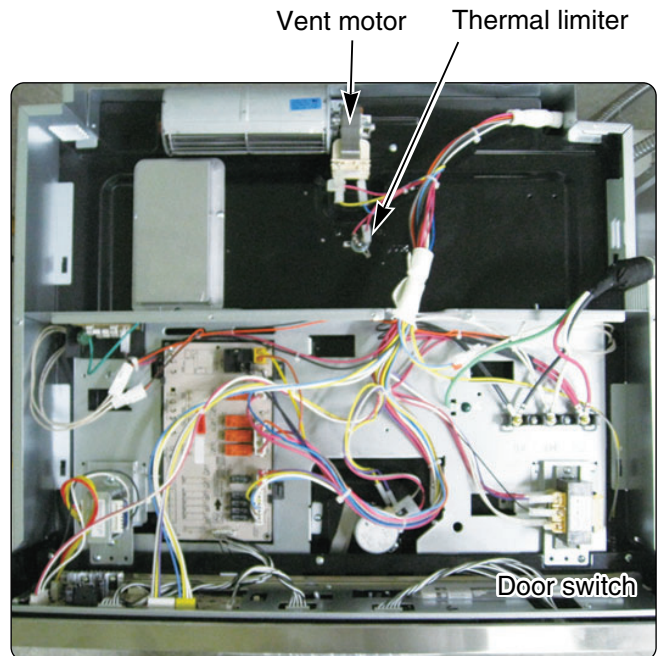
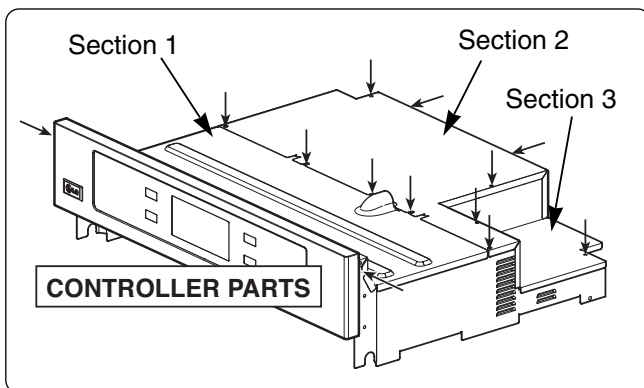

4. Vent motor, Thermal Limiter, and Door switch can be serviced here.

- 1) **To remove the vent motor**, remove the 2 screws and disconnect connector.

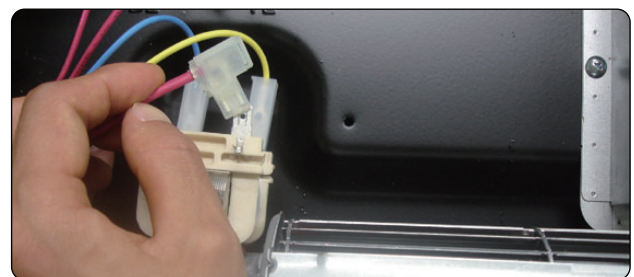
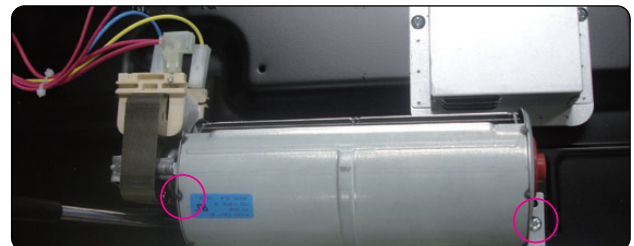

DISASSEMBLY INSTRUCTIONS

COOLING FAN (BLOWER)

- Self Clean Mode: The cooling fan can operate at 2 different speeds based on temperature. If the temp is above 482°F/250°C the fan will operate on high. If temp is below 482°F/250°C the fan will operate on low.
- Normal Cooking Mode: If the oven temperature reaches 212°F/100°C, the cooling fan will operate at low speed at a time.

- 2) **To remove thermal disk**, remove the 1 screw and remove the 2 wires.

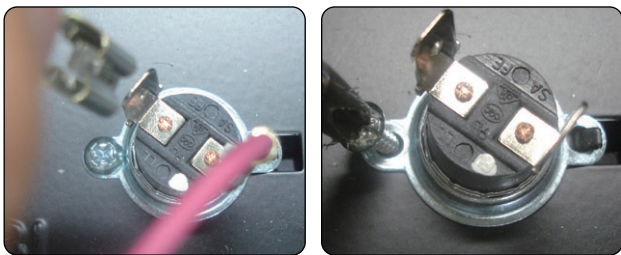

THERMAL LIMITER

- **To shut down the control power transformer**
The upper thermostat is located in front of the cooling fan. It opens at 356°F/180°C and closes when the oven temperature cools below 14°F/-10°C.
The lower thermostat is located next to the broil element. It opens at 356°F/180°C and closes when the oven temperature cools below 14°F/-10°C.

- 3) **To remove door switch**, Remove the 1 screw from the top right panel.

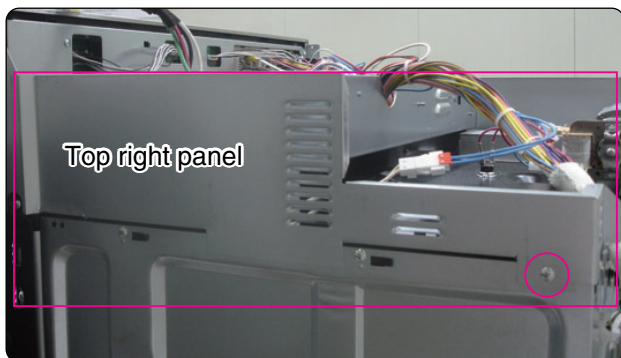

- 4) Squeeze tabs on switch and slide through the front.
Disconnect the wires from terminals.

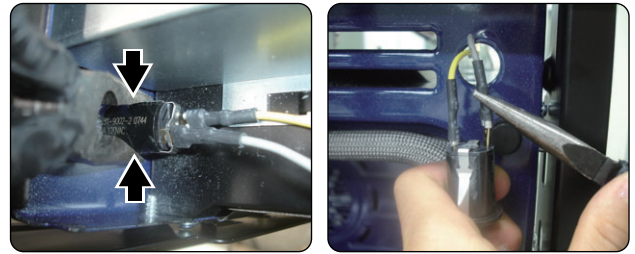

6. To remove the Thermal limiter, Convection motor, and Bake Element from the oven, Follow the steps as follows.
Remove the rear cover.

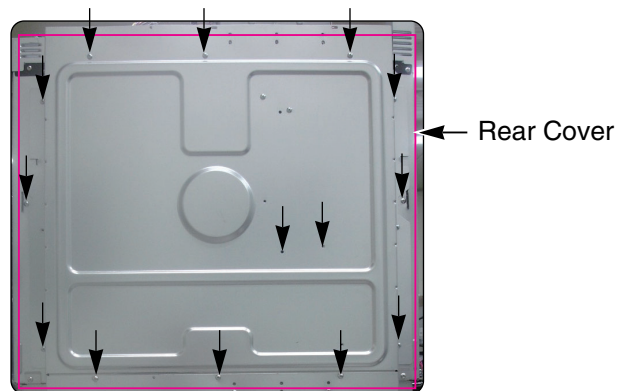

Thermal Limiter (Double Line Break) Convection motor

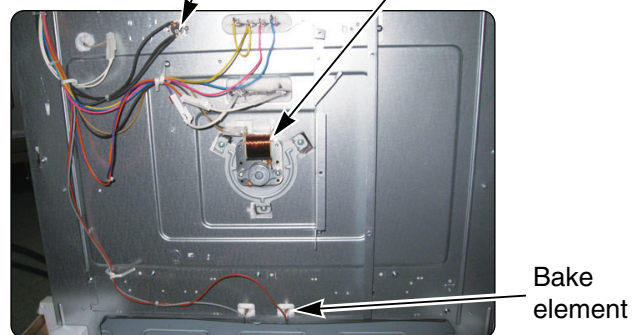

DISASSEMBLY INSTRUCTIONS

- 1) To Remove Thermal Limiter (Double Line Break), remove the screw and 2 wire leads.

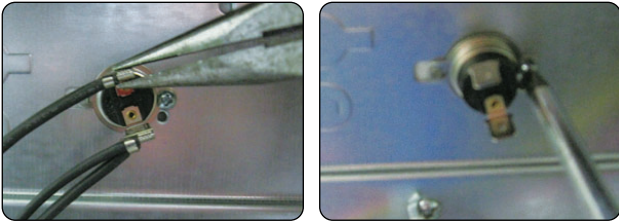

THERMAL LIMITER

• To shut down the heaters

The thermostat is located at the back of the oven next to the broil element and wired in series with the Double Line Break relay. The oven thermostat opens at 356°F/180°C. (Reclose Temp. : -31°F/-35°C)

- 2) To remove convection motor assembly

Before removing the convection fan motor, first follow the steps for removing Convection Heater.

- a. Disconnect the 2 wire leads and remove the 3 screws from the motor bracket

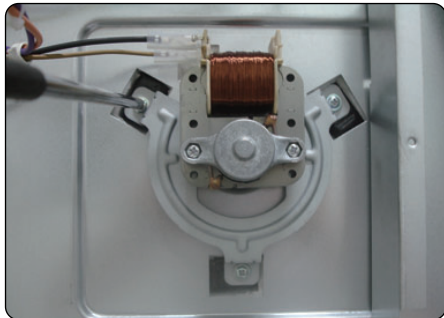

- b. Separate parts of cavity inner between cavity outer properly.
(refer to the page3-5 About cavity inner disassembly method)

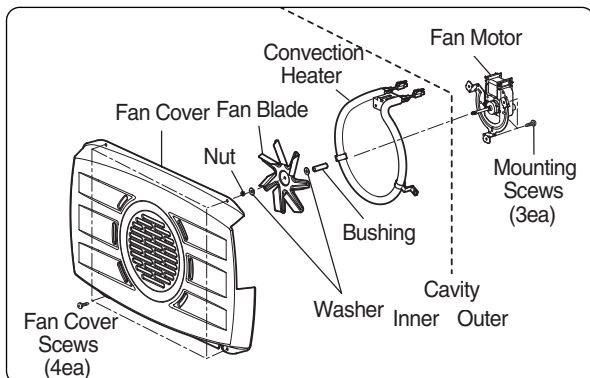

- 3) To remove the hidden bake element

- a. Remove the Barrier bracket.

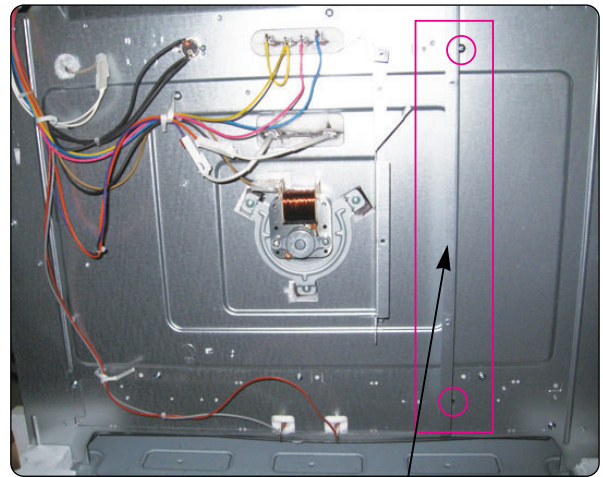

Barrier bracket

- b. Disconnect the 2 wire leads, remove the Bake element cover.

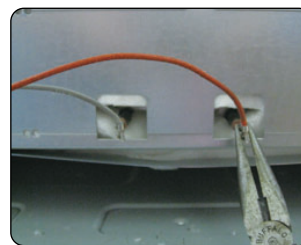

Bake element cover

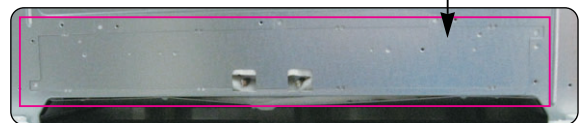

- c. Cut the 8 points of flange and remove the Bake element cover.

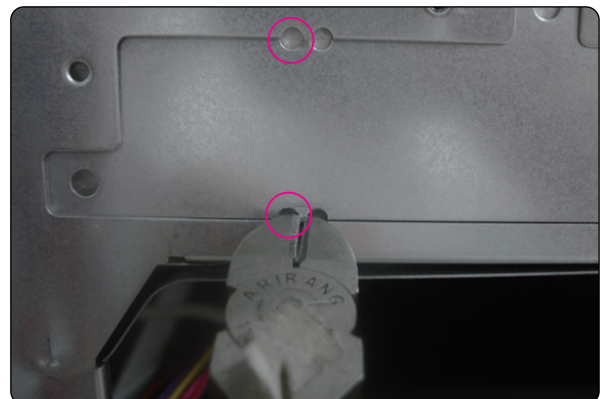

DISASSEMBLY INSTRUCTIONS

- d. Bend the insulator up and remove the 1 screw.

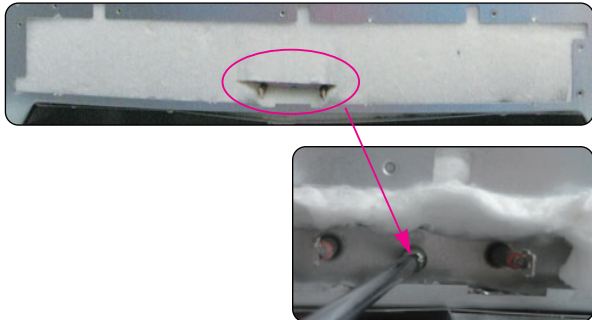

- e. Carefully pull the hidden bake element out of the oven.



- f. When replacing the Bake Element cover use the 5 screws provided.

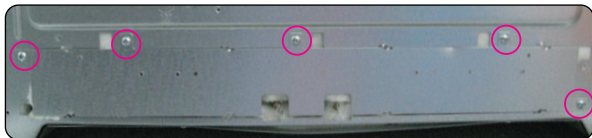

DISASSEMBLY INSTRUCTIONS

REMOVING & REINSTALLING THE LIFT-OFF OVEN DOOR

CAUTION

The door is very heavy. Be careful when removing and lifting the door. Do not lift the door by the handle.

To remove the door:

1. Fully open the door.

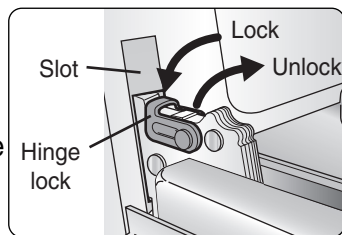

<Fig.1>

2. Pull the hinge locks down toward (Fig.1) the door frame, to the unlocked position.

3. Firmly grasp both sides of the door at the top.

4. Close door to the door removal position, which is approximately 5 degrees. (refer to the Fig.2)

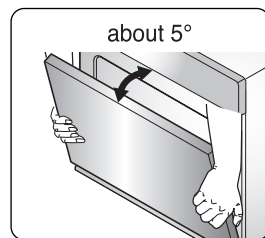

<Fig.2>

5. Lift door up and out until the hinge arm is clear of the slot.

To replace the door:

1. Firmly grasp both sides of the door at the top.

2. With the door at the same angle as the removal position, seat the indentation of the hinge arm into the bottom edge of the hinge slot. The notch in the hinge arm must be fully seated into the bottom of the slot.

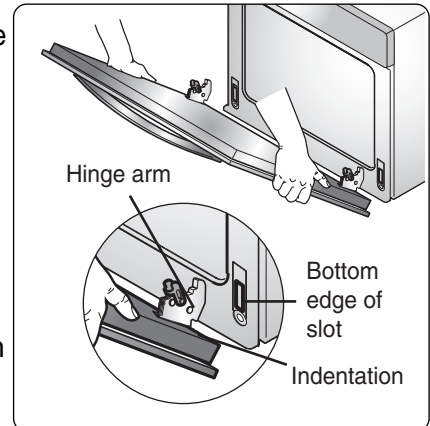

3. Fully open the door. If the door will not fully open, the indentation is not seated correctly in the bottom edge of the slot.

4. Push the hinge locks up against the front frame of the oven cavity to the locked position.

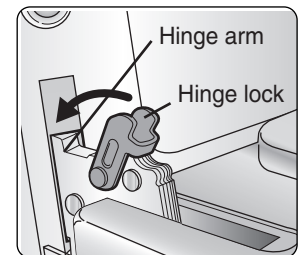

5. Close the oven door.

DISASSEMBLY INSTRUCTIONS

REMOVING THE OVEN DOOR HANDLE & GLASS

CAUTION

- Be careful when you work on the electric oven handling the sheet metal part.

1. Remove the oven door from the oven. (see page 3-11)
2. Place the oven door on a padded work surface with the front glass facing down.
3. Remove the 4 top door screws.

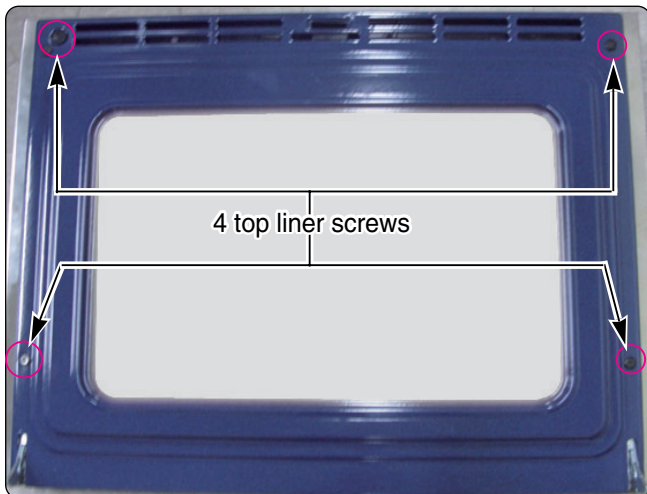

4. Remove the three bottom screw from the door liner.



5. Lift the inner assembly off the front glass and set it aside

6. To remove the door handle & trim.
 - a. Remove 2 screws for handle and replace.
 - b. Slide Door trim up and off.

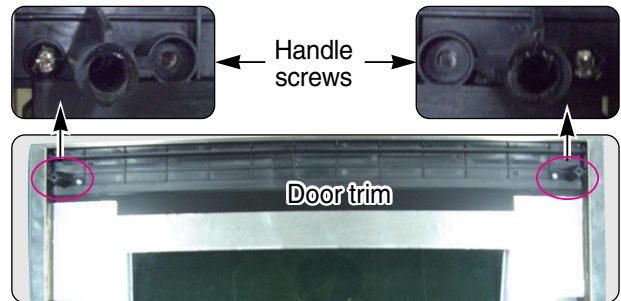

7. To remove the hinge assembly :

- 1) Remove the 2 lower liner screws (see step 3)
- 2) Place the door liner assembly on a padded work surface with the hinge over the edge.
- 3) Remove the two hinge hanger screws.

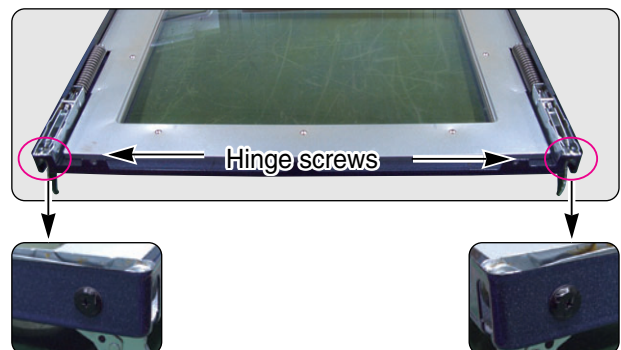

- 4) Remove the 8 screws.

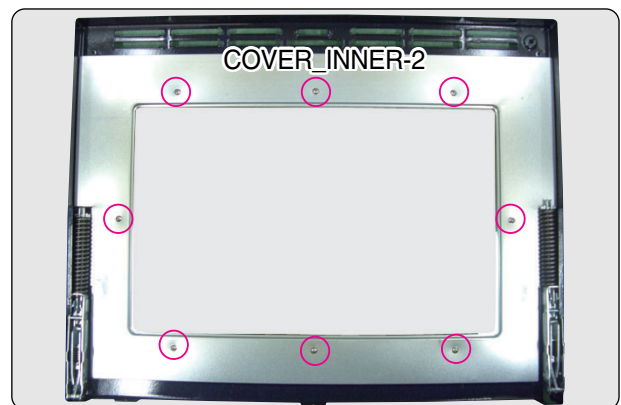

DISASSEMBLY INSTRUCTIONS

- 5) Lift the COVER_INNER-2 off the door liner.
- 6) Lift the hinge out of the door liner slot.

To remove the oven door glass assembly:

- 7) Lift the COVER_INNER-1 off the door liner.



- 8) Lift the inner oven door glass and bracket assembly out of the door liner.



DISASSEMBLY INSTRUCTIONS

REMOVING THE OVEN DOOR GASKET

1. Remove oven door
2. Pull the oven door gasket clips out of the liner holes until all of the clips are removed.

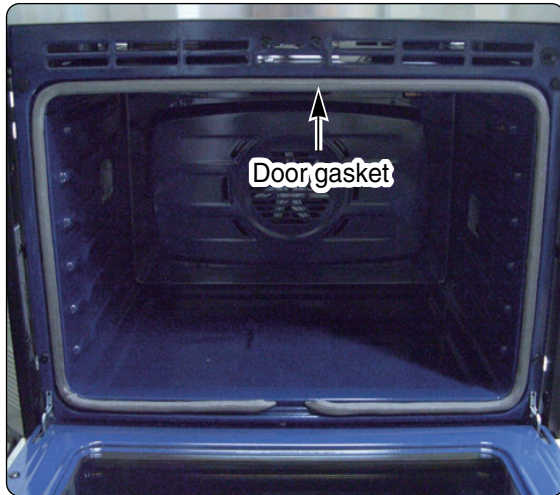

3. Pull the ends of the gasket out of the liner holes.

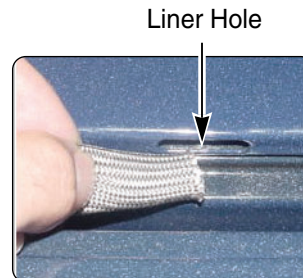

REASSEMBLY NOTE: When reinstalling the new gasket, make sure that all of the clips are seated in their liner holes, and that the ends of the gasket are pushed fully into their holes. Use the pointed end of a pencil to push the gasket ends into the holes.

COMPONENT TEST

Before testing any components, perform the following checks:

NOTE:

1. The most common cause for control failure is corrosion on connectors.
Therefore, disconnecting and reconnecting wires will be necessary throughout test procedures
2. If this is a new product check all connections before replacing parts.



1. All test and checks should be made using a VOM or DVM having a range of at least 20,00 ohms or greater.
2. Be sure to check all connections before replacing components. Look for broken or loose wire, failed terminals or wires not fully seated into the connectors.
3. Resistance checks must be made with power disabled form oven, and with wiring harness or connectors disconnected.

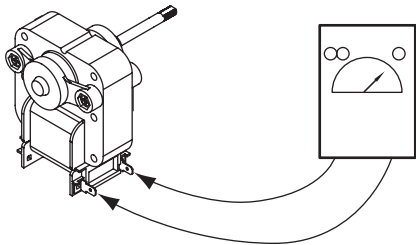

⚠ WARNING

- Disconnect power supply before servicing
- Replace all panels and parts before operating
- Reconnect all grounding devices after servicing
- Failure to do so can result in death or electrical shock

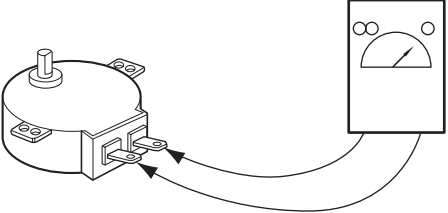
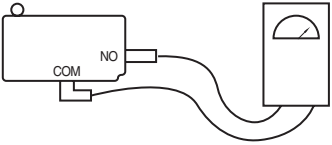
NOTE: Below Ω value were tested at room temperature (77F/25°C)

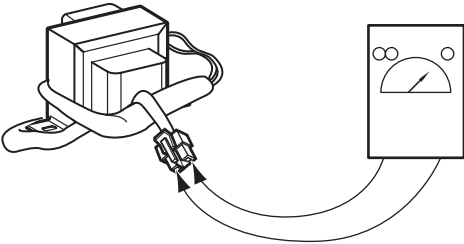
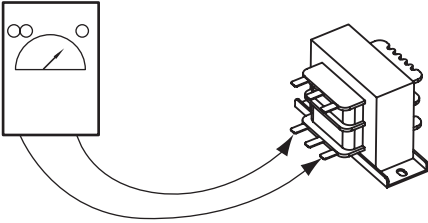
Components	Test procedures	Results
<p>Convection Motor</p>	<ol style="list-style-type: none"> 1. Refer to page 3-8 for Disassembly 2. Measure the resistance (Multiple meter scale: R x 1) 	<p>Normal: Approximately 17 Ω Replace if: Infinite (opened) below 5 Ω (shorted)</p>

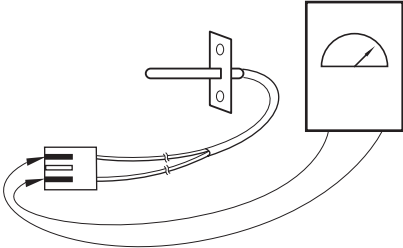
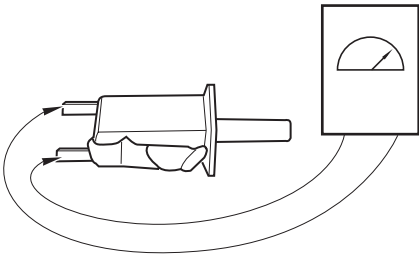
Components	Test procedures	Results	
Door locking Motor	1. Refer to page 3-10 for disassembly 2. Measure the resistance (Multiple meter scale: R x 1000) 	Normal: Approximately 2550 Ω Replace if: Infinite (opened) below 5 Ω (shorted)	
Door locking micro switch (normally close type)	1. Refer to page 3-10 for disassembly 2. Measure the resistance (Multiple meter scale: R x 1000) 	Door latch open	Door latch Locked
	<p>NOTE: After checking for the continuity of switch, make sure to reconnect leads properly.</p>	 Continuity	 Infinite
Low Voltage Transformer - Controller	1. Refer to page 3-2 for disassembly 2. Measure the resistance (Multiple meter scale: R x 1) 	Normal: Approximately 26 Ω ± 10% Replace if: Infinite or below 1Ω	
Low Voltage Transformer - Halogen lamp	1. Refer to page 3-2 for disassembly 2. Measure the resistance (Multiple meter scale: R x 1) 	Normal: Approximately 9.8 Ω ± 10% Replace if: Infinite or below 1Ω	

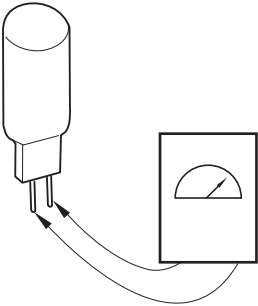
Components	Test procedures	Results	
Oven Thermistor	1. Refer to page 3-5 for disassembly 2. Measure the resistance after cool down (Multiple meter scale: R x 1000) 	Normal: Approximately 1090 Ω Replace if: Infinite (opened) below 10 Ω (shorted) NOTE: Ω Value should be tested at room temperature (77F/25°C)	
NOTE: After checking for the continuity of switch, make sure to reconnect leads properly.			
Door switch	1. Refer to page 3-7 for disassembly 2. Measure the resistance after cooling down (Multiple meter scale: R x 1) 	Door open	Door closed
		 Continuity	 Infinite
Oven lamp	1. Refer to page 3-5 for disassembly 2. Measure the resistance after cool down (Multiple meter scale: R x 1) 	Normal: Below 5 Ω . Replace if: Infinite	

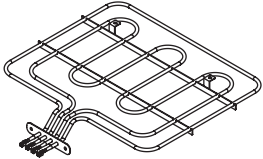
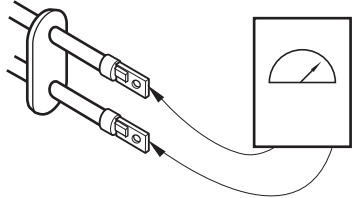
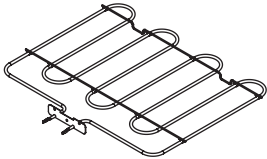
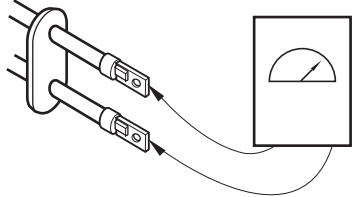
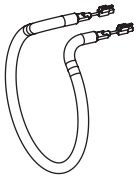
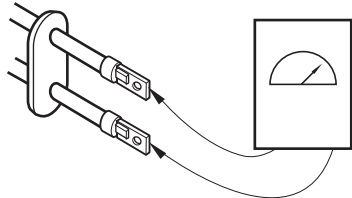
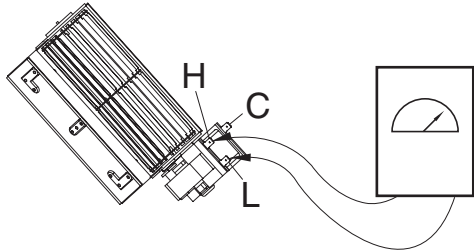
Components	Test procedures	Results
<p>Broil Element</p> 	<p>1. Refer to page 3-4 for disassembly 2. Measure the resistance after cool down (Multiple meter scale : R x 1)</p> 	<p>Normal: Approximately Inner: 22.5 Ω Outer: 36.9 Ω Replace if: Infinite (opened)</p> <p>NOTE: Outer Broil element use Outer yellow and Blue terminals to check resistance. Inner Broil element use inner yellow and pink terminals to check resistance.</p> <p>NOTE: Ω Value should be tested at room temperature (77F/25°C)</p>
<p>Bake Element</p> 	<p>1. Refer to page 3-8 for disassembly 2. Measure the resistance after cool down (Multiple meter scale : R x 1)</p> 	<p>Normal: Approximately 22.5 Ω Replace if: Infinite (opened)</p> <p>NOTE: Ω Value should be tested at room temperature (77F/25°C)</p>
<p>Convection element</p> 	<p>1. Refer to page 3-4 for disassembly 2. Measure the resistance after cool down (Multiple meter scale : R x 1)</p> 	<p>Normal: Approximately 32.5 Ω Replace if: Infinite (opened)</p> <p>NOTE: Ω Value should be tested at room temperature (77F/25°C)</p>
<p>Vent motor</p>	<p>1. Refer to page 3-6 for disassembly 2. Measure the resistance after cool down (Multiple meter scale : R x 1)</p> 	<p>Normal: Approximately H ~ C: 16 Ω L ~ C: 20 Ω Replace if: Infinite (opened) below 5 Ω (shorted)</p> <p>NOTE: Ω Value should be tested at room temperature (77F/25°C)</p>

DIAGNOSIS THROUGH SCHEMATIC

Apply schematic from Tech sheet.

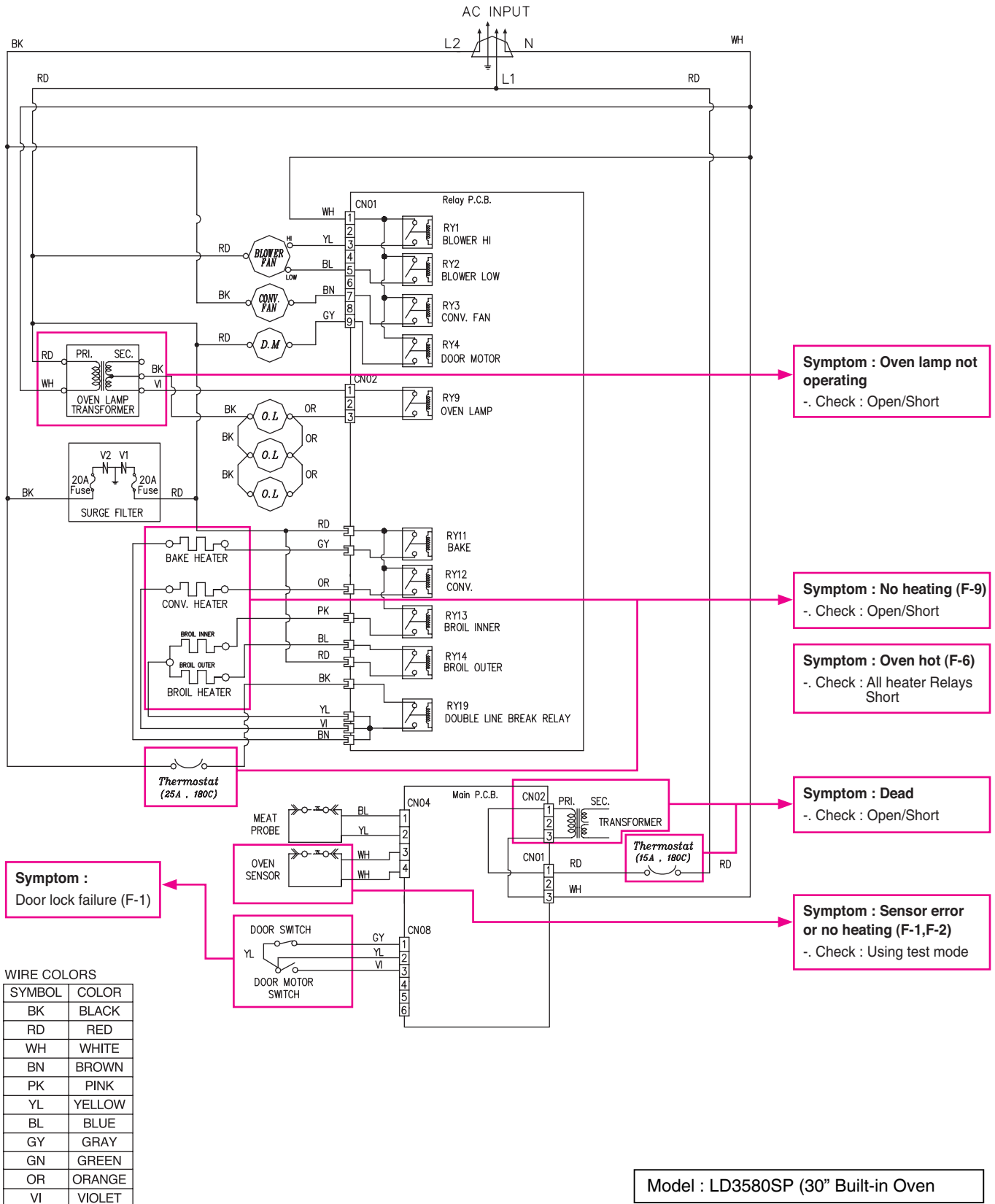

WIRE COLORS

SYMBOL	COLOR
BK	BLACK
RD	RED
WH	WHITE
BN	BROWN
PK	PINK
YL	YELLOW
BL	BLUE
GY	GRAY
GN	GREEN
OR	ORANGE
VI	VIOLET

Model : LD3580SP (30" Built-in Oven)

HOW TO ENTER THE TEST MODE

How to enter the Test mode

NOTE : Before entering Test Mode make sure to record the customers settings, such as items in MY MENU and SET UP. When the Test Mode is activated it can erase items the customer has added or changed in these menus.

To enter the test mode,

- 1) Remove power from the oven.
- 2) Return power to the oven

Note: do not set the time of day

- 3) Then press Start, Timer on /off, Oven light, and Start again.

Note: Follow the sequence above by pressing each key individually.

If you push **START - TIMER - LIGHT - START** button in order, you can enter the test mode.

It's possible to enter the test mode after power is on.

And any keys should not be pushed, even though LG Logo is disappeared on the screen.

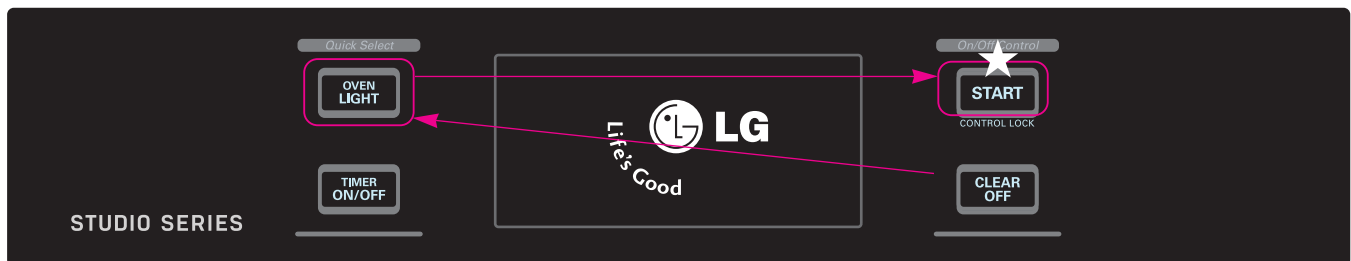

How to enter the Test Mode in the Main Mode

1. If you push **Set Up Menu -START - HiddenKey(3) - START** button in order, you can enter the test mode again.

- 1) Select Set up from main menu.

- 2) Press start, then the 3 hidden keys from top to bottom, then press start again.

Note: Follow the sequence above by pressing each key individually.

2. How to cancel the Test Mode : Push Clear/Off Key under the Test Mode.

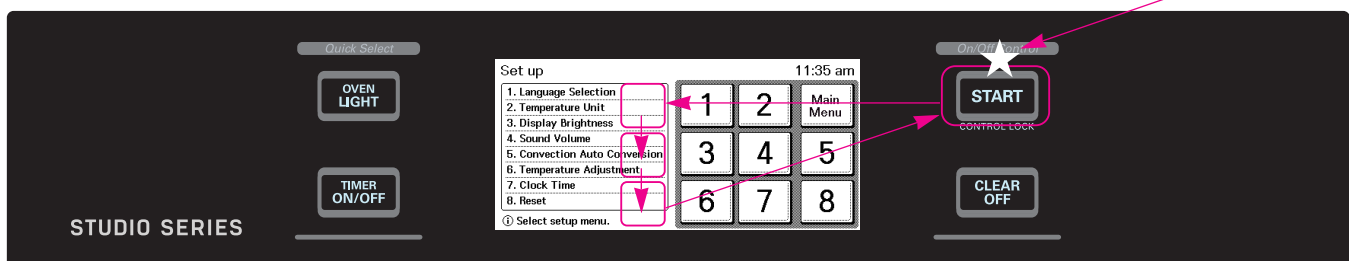
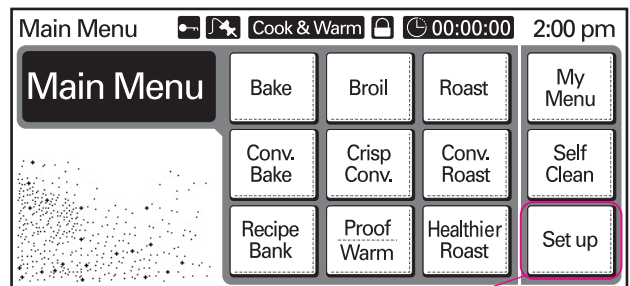

SAFETY CAUTION & ERROR CODE SUMMARY

1.1 Safety Caution

- Normal State is power OFF, unless described differently as power ON.

1.2 Error Code Summary

Code	Description	Operation
F-1	Opened Sensor	Oven Thermistor remain open for over 1 min, after cook starts
F-2	Shorted Sensor	Oven Thermistor is shorted for over 1 min after cook starts
F-3	Touch Sensor Key Error	When touch sensor key has some error for ≥ 60 second.
F-6	Oven hot	Oven temperature is over 650°F / 343°C continuously during 2 minutes on cooking.
F-8	Temp Probe	Temp Probe Thermistor is shorted for over 1 min after cook starts
F-9	No heating	If oven temperature in the oven does not exceed 150°F / 66°C in less than 5 minutes.
F-10	Door Lock Fail	Oven in case of Door Lock Failure
F-11	Comm Error	Communication error between user interface and main PCB for over 10 seconds.
F-12	EEPROM Error	EEPROM Error for My Menu.

CHECKING FLOW CHART BY FAILURE MODE

Dead

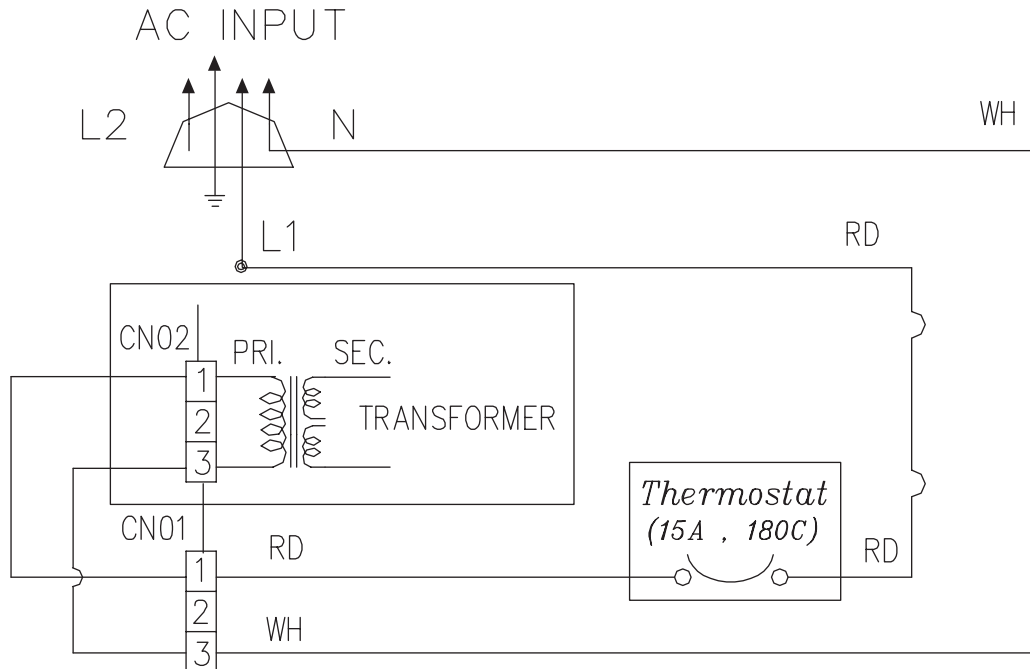

Symptom	Check Point
1. Dead 2. No Display	1. Check for power to wall oven 2. Check the thermostat. 3. Check the Transformer. 4. Check the System and Display

CHECKING FLOW CHART BY FAILURE MODE

Dead

No display

Power off

Check for loose connector's.
or disconnect CN01, CN02, CN03
between system(CN10) and display(CN10)

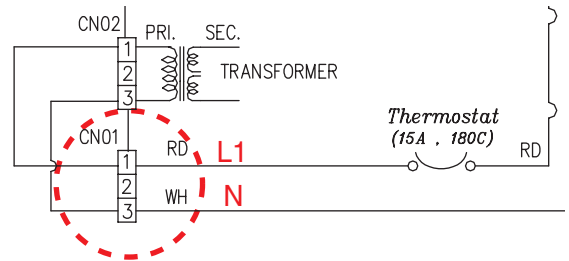
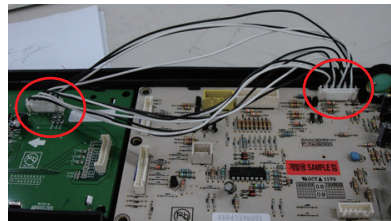
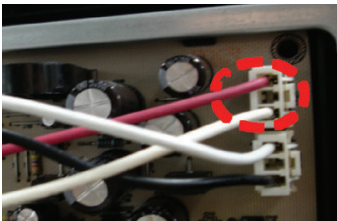

Connector is ok?

No

Fix the connection

END

Yes

Power On

Check AC input voltage of oven System PCB
- CN01 (pin 1 and 3) Should have 120VAC.

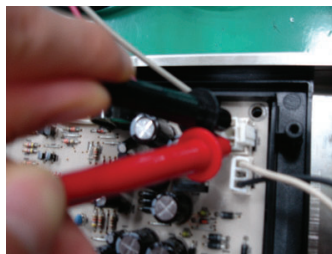

1

CHECKING FLOW CHART BY FAILURE MODE

Dead

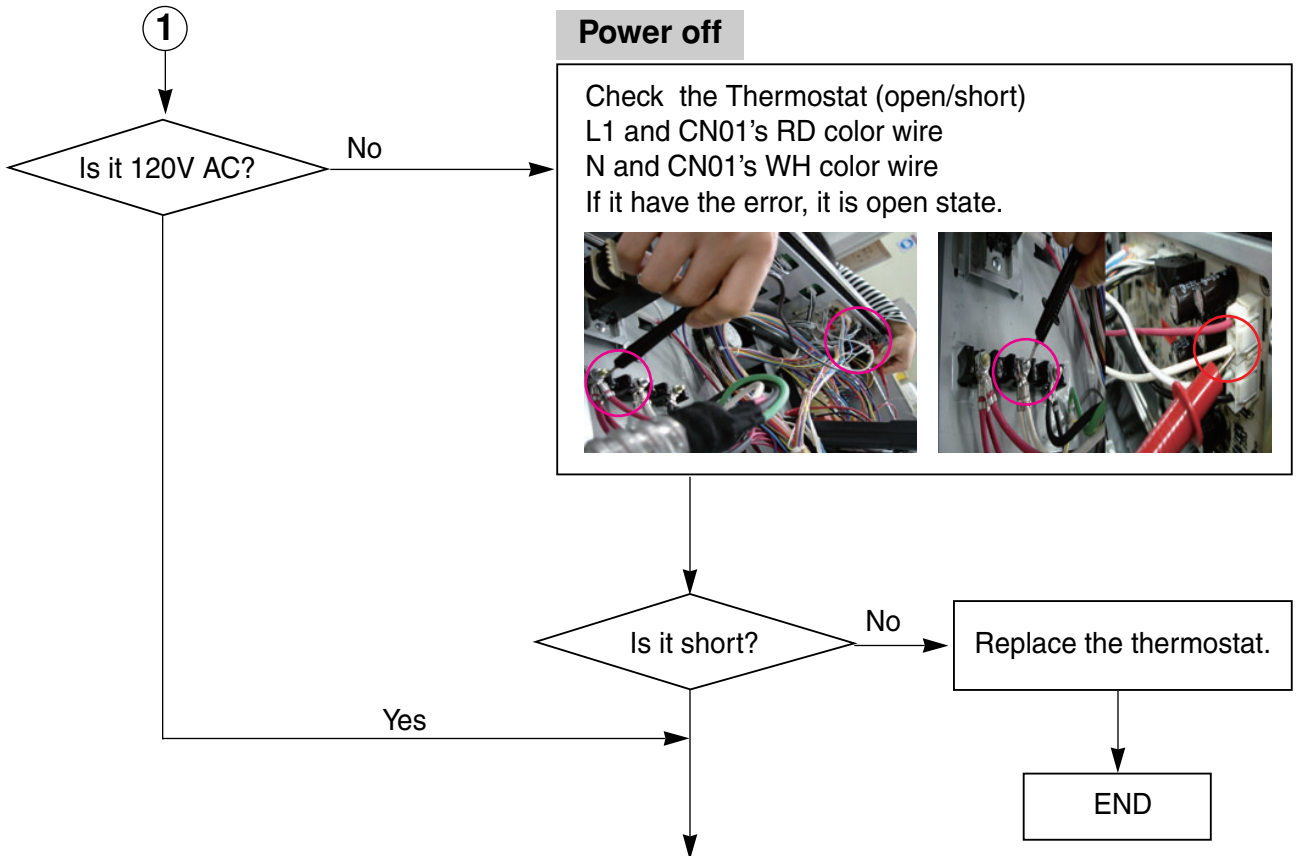

Check the power transformer(Refer to the below)

Primary

Secondary1

Secondary2

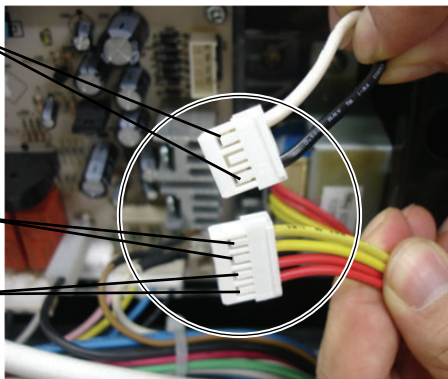

Side	Lead color	Coil resistance
Primary 1	Black ~ white	approximately Under100[Ω]
Secondary 1	yellow ~ yellow	approximately Under 50 [Ω]
Secondary 2	red ~ red	approximately Under 50 [Ω]

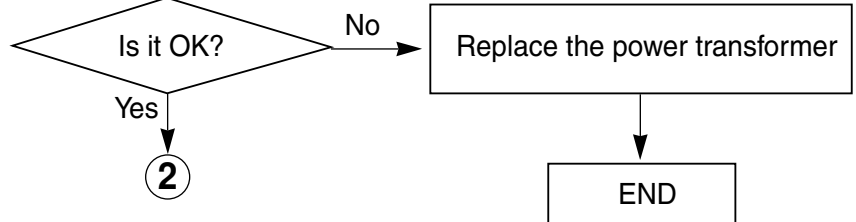

CHECKING FLOW CHART BY FAILURE MODE

Dead

2

Power On

Check the System's Vcc –
CN10's pin11(Vcc) and pin9 (GND)

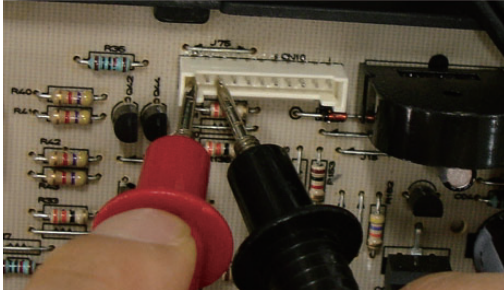

The voltage should
be 4.5 VDC ~ 5.8 VDC.

Is the voltage OK?

No

Replace the system PCB

END

Check the Display's Vcc–CN10's pin11(Vcc) and pin9 (GND) or C228 or C19
Don't remove the harness



The voltage should be 4.5 VDC ~ 5.8 VDC

3

CHECKING FLOW CHART BY FAILURE MODE

Dead

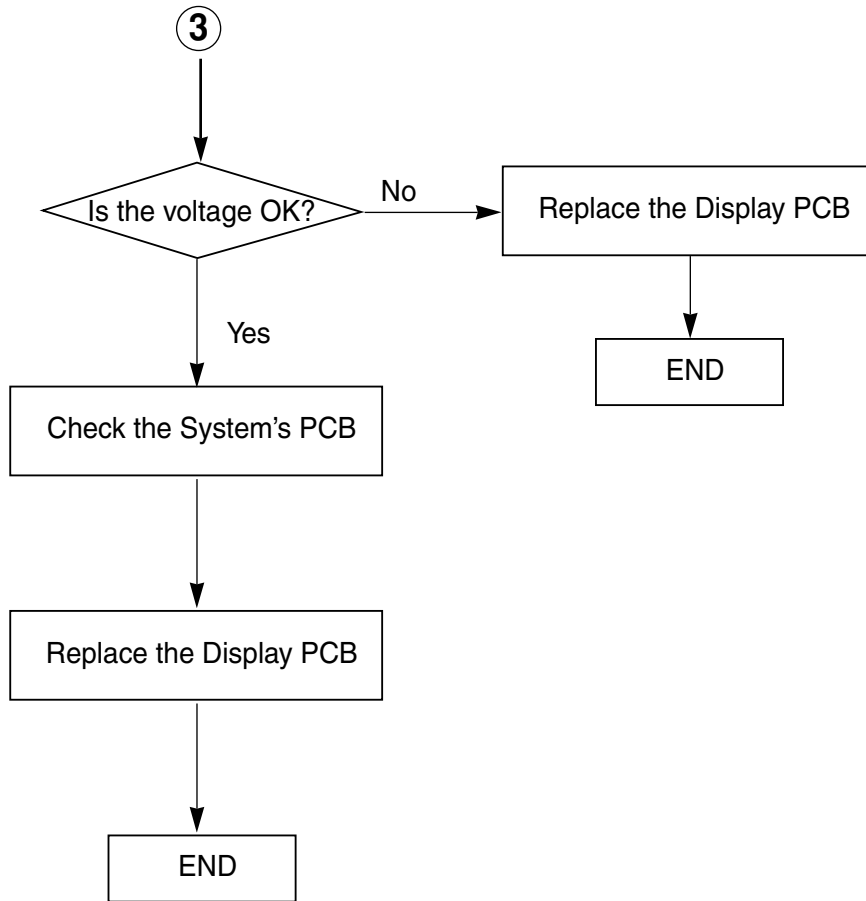

CHECKING FLOW CHART BY FAILURE MODE

Oven does not heat (including F-9 error)

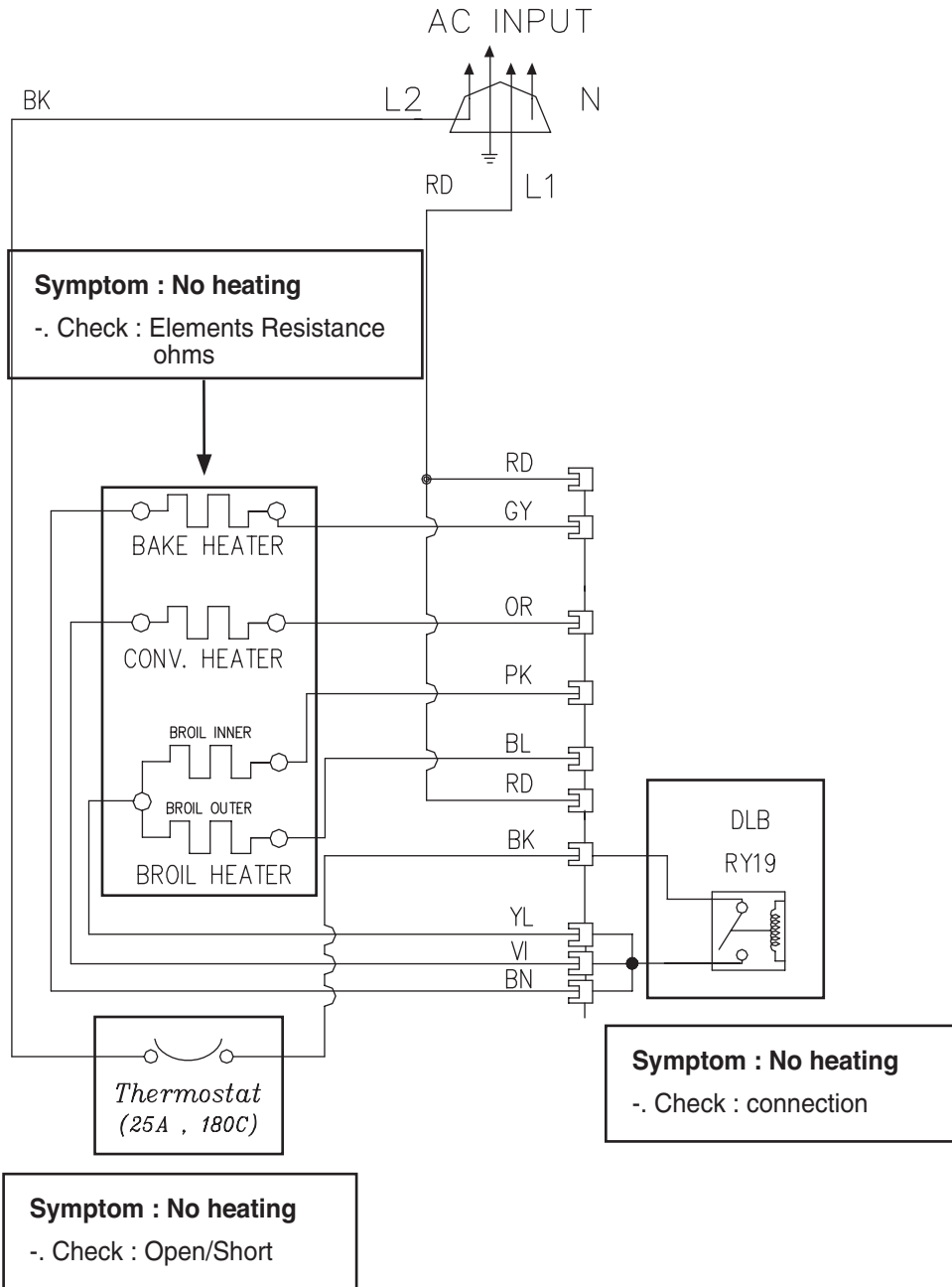

Symptom	Check Point
No heating	<ol style="list-style-type: none"> 1. Check Electric wiring and PCB's connection. 2. Check the thermostat. 3. Check the heater's resistor. 4. Check the sensor.

CHECKING FLOW CHART BY FAILURE MODE

Oven does not heat (including F-9 error)

No heating(including F-9 error)

Disconnect power

Check the electric wire connection DLB and and harness of Relay and each heater's connection. And system PCB and Relay PCB(CN11) Loose connection and disconnection

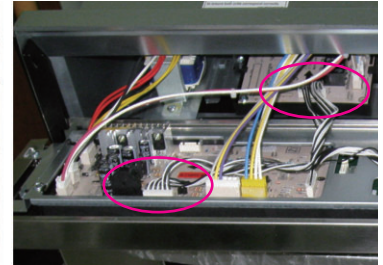
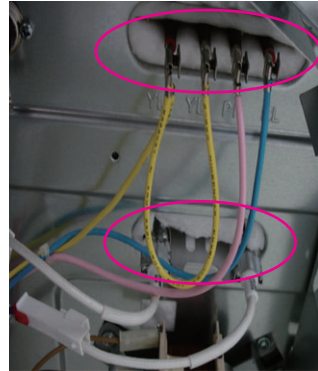

Is connection OK?

No

Fix the connection

END

Yes

Check the thermostat open/short between DLB Relay's L2 and L2 (BK wire) If it have the error, it is open state.

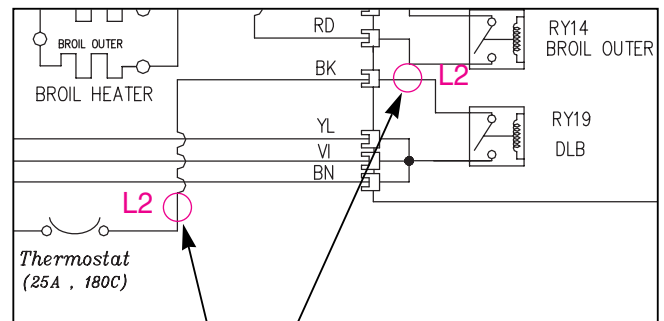
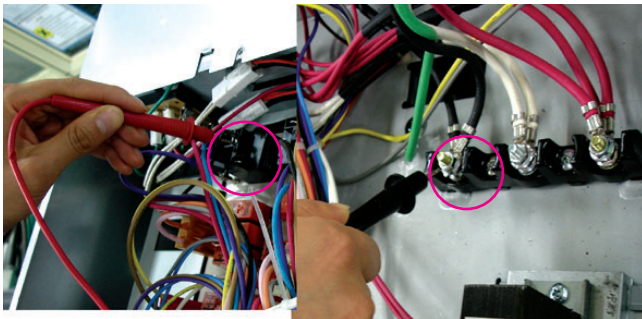

Thermostat (25A , 180C)

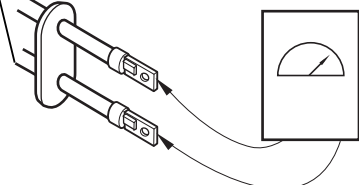

Is it short?

No

Replace the thermostat.

END

1

CHECKING FLOW CHART BY FAILURE MODE

Oven does not heat (including F-9 error)

①

Measure the Resistor of each heater Between the DLB Relay's L2 and each heater Relay's Harness point of Figure 1 (①, ②, ③, ④ and ⑤) (measure the resistance after cooling down)
Normal:

Resistor	Min	Max
Bake	22.0	35.0
Convection	25.0	42.0
Inner broil	22.0	35.0
Outer broil	35.0	46.0

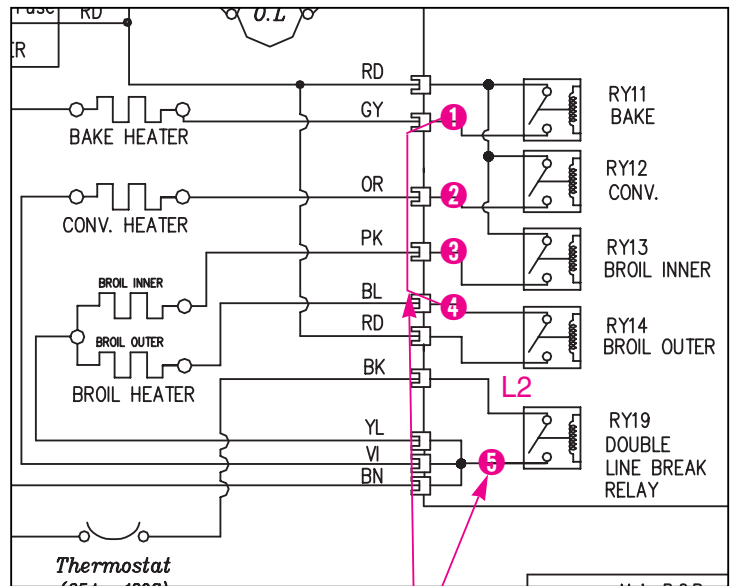
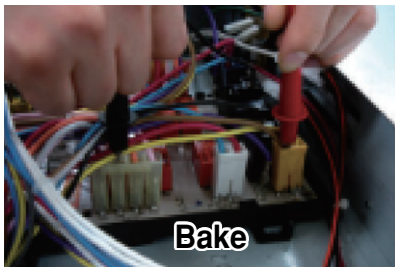
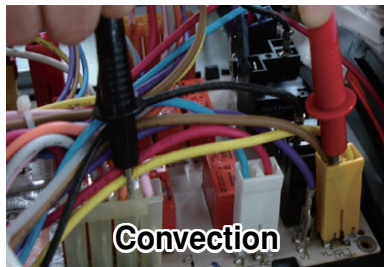

Figure 1



Bake



Convection

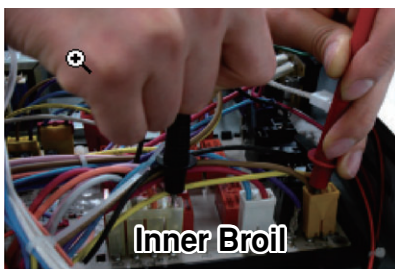

Inner Broil



Out Broil

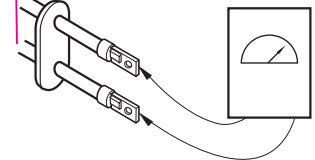

If it is not correct,
Measure heater resistance directly.

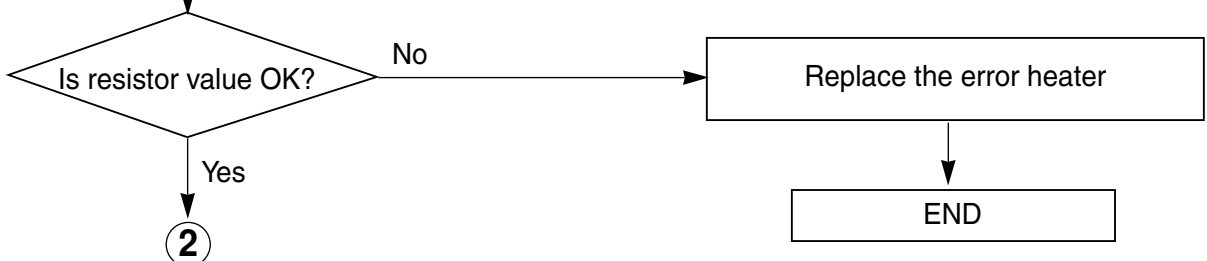

CHECKING FLOW CHART BY FAILURE MODE

Oven does not heat (including F-9 error)

②

Power On

Check the thermistor using the test mode 4. **Diagnosis**
Oven sensor.
After value the sensor value are 70°F ~ 90°F (at 24°C)

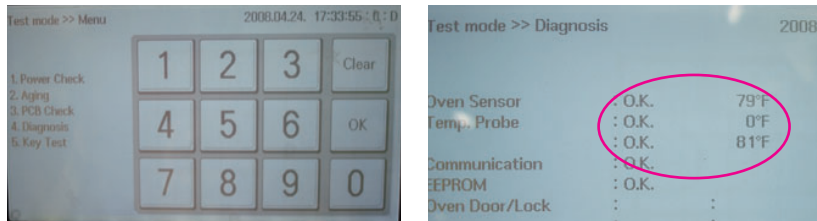

Is the value OK?

No

Yes

Power Off

Check the thermistor's resistor
CN04 pin3, 4
Normal: approximately 1.09 kΩ

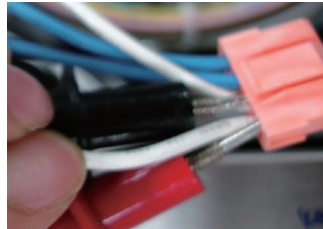

Is the value OK?

No

Yes

Replace the Sensor

END

Replace the Relay PCB

OK?

No

Yes

Replace the System PCB

END

CHECKING FLOW CHART BY FAILURE MODE

Not operating Key (including F-3 error)

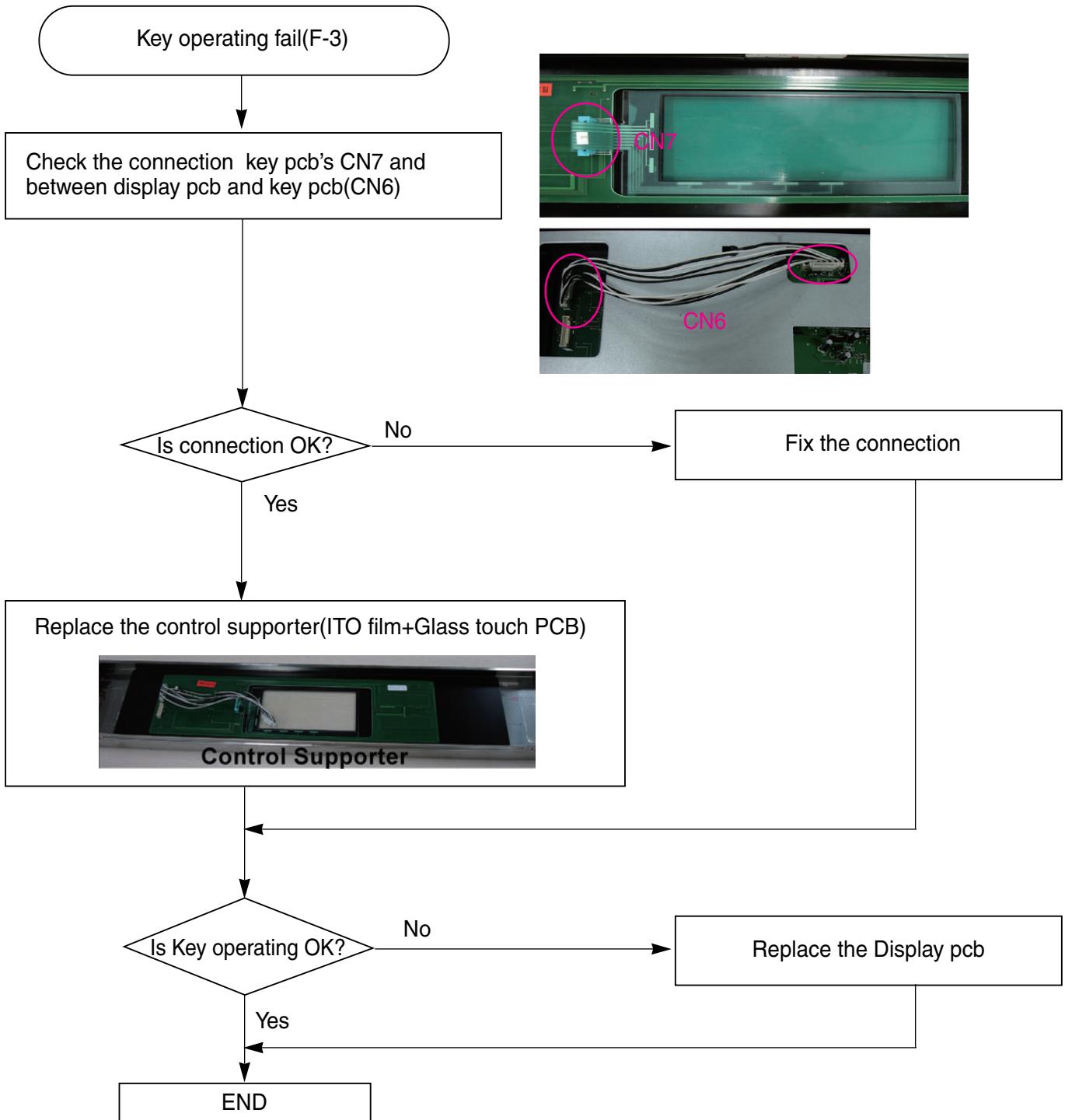

CHECKING FLOW CHART BY FAILURE MODE

lock system failure(including F-10 error)

Just after self-clean start,the door lock motor starts to rotate. During that time if the door lock switch does not operate properly after rotating twice, then supervising circuit detects a Door Lock failure and the F-10 error code appears.

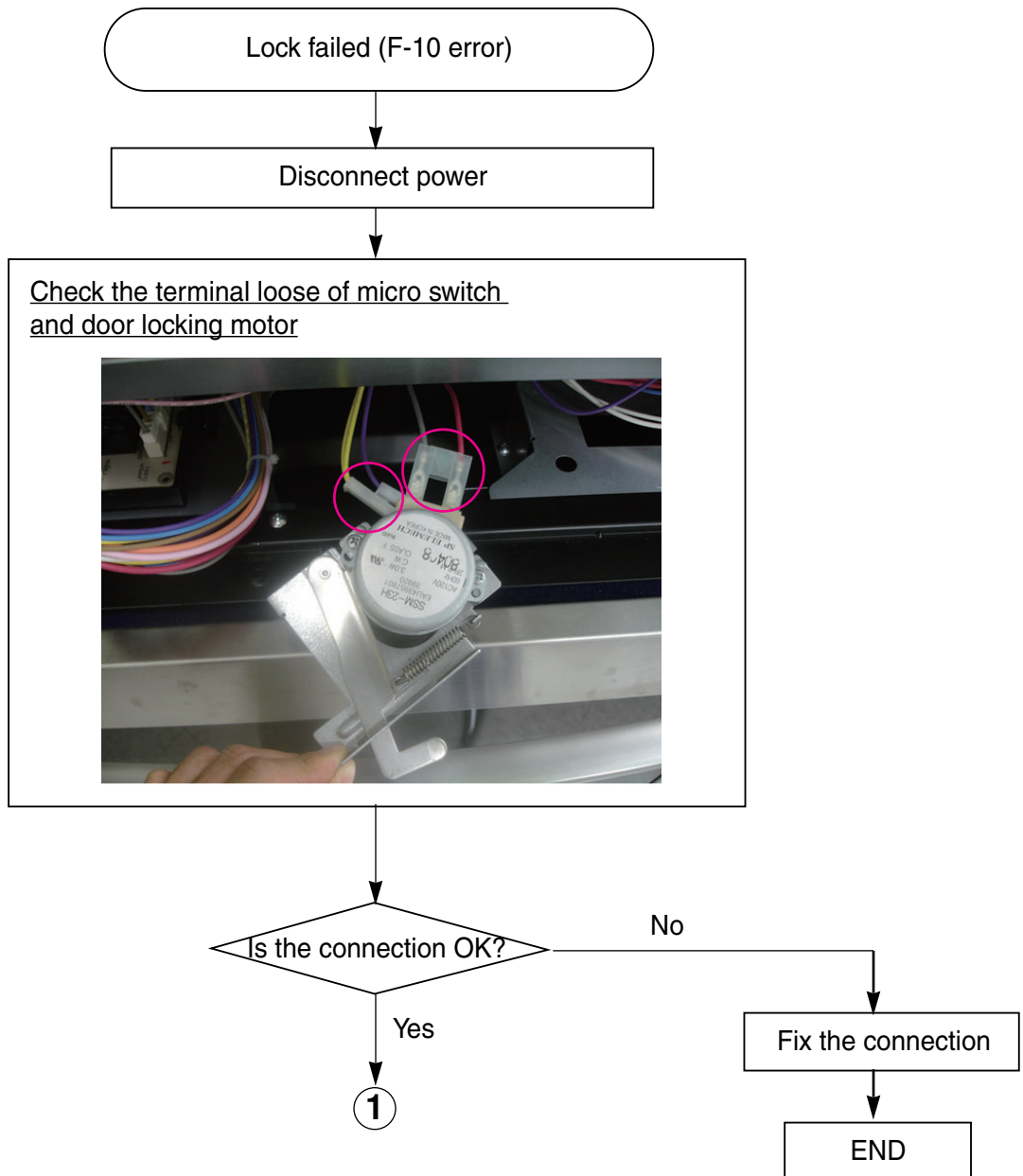

CHECKING FLOW CHART BY FAILURE MODE

lock system failure(including F-10 error)

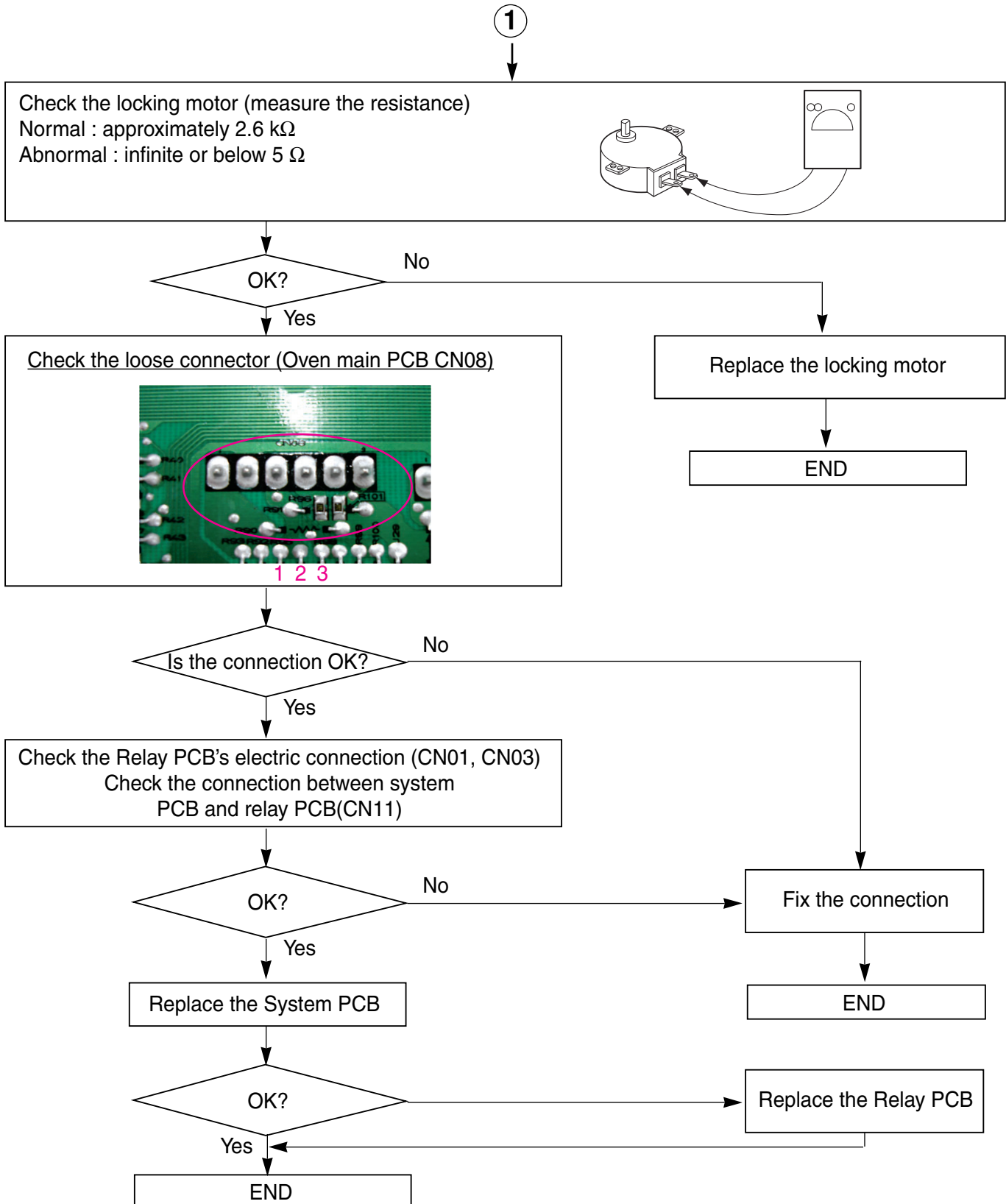

CHECKING FLOW CHART BY FAILURE MODE

Oven Thermistor failed(including F-1, F-2 error)

oven sensing failed
(including sensor error)

Check the thermistor using the test mode 4. **Diagnosis**
Oven sensor.
After value the sensor value are 70°F~90°F(at 24°C)

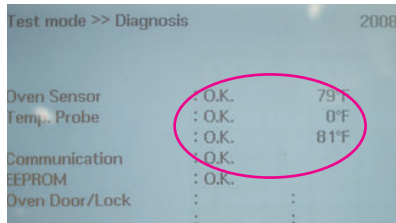
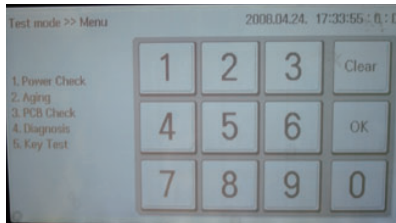

Is the value OK?

No

Yes

Power Off

Check the thermistor's resistor
CN04 pin3, 4
Normal: approximately 1.09 kΩ

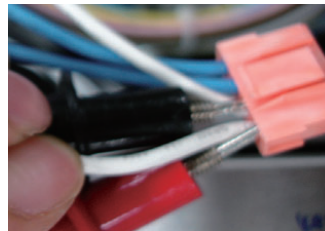

Is the value OK?

No

Yes

Replace the Sensor

Replace the system PCB

END

CHECKING FLOW CHART BY FAILURE MODE

Oven too hot (including F-6 error)

Oven is too hot(F-6 error)

Disconnect power

Remove the relay PCB harness
and pull the relay PCB forward from case

Check the L1(TAB1, 18/TAB6, 20) and all the heater relay welded or not.
(AND measure the resistance)

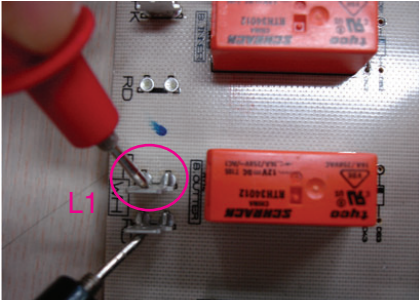

Welded	Normal
Continuity	Infinite

Normal?

No

Yes

Replace the system PCB

Replace the relay PCB

END

CHECKING FLOW CHART BY FAILURE MODE

Communication error → F-10 error

F-10 error (communication error)

Check the PCB's test mode
Check the 4. **Diagnosis**
Communication check
Ok or NG.

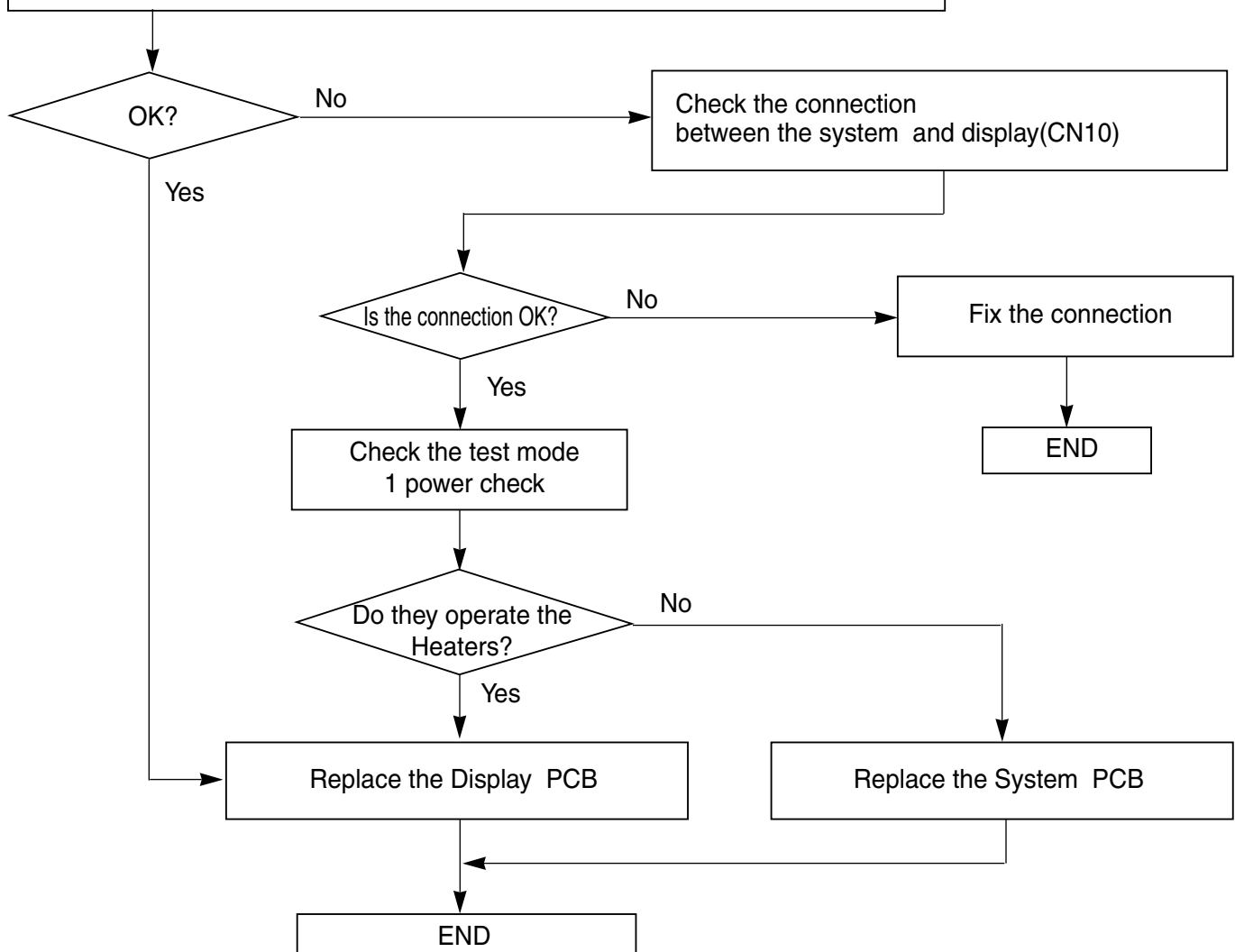
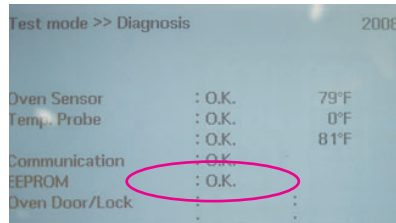
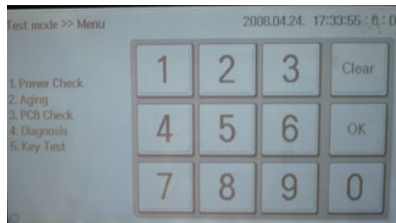

SCHEMATIC DIAGRAM

⚠ WARNING

POWER MUST BE DISCONNECTED BEFORE SERVICING THE APPLIANCE. FAILURE TO DO SO CAN RESULT IN DEATH OR ELECTRICAL SHOCK.

NOTE:

Schematic diagram shows oven door closed and unlocked. All elements are set to "OFF".

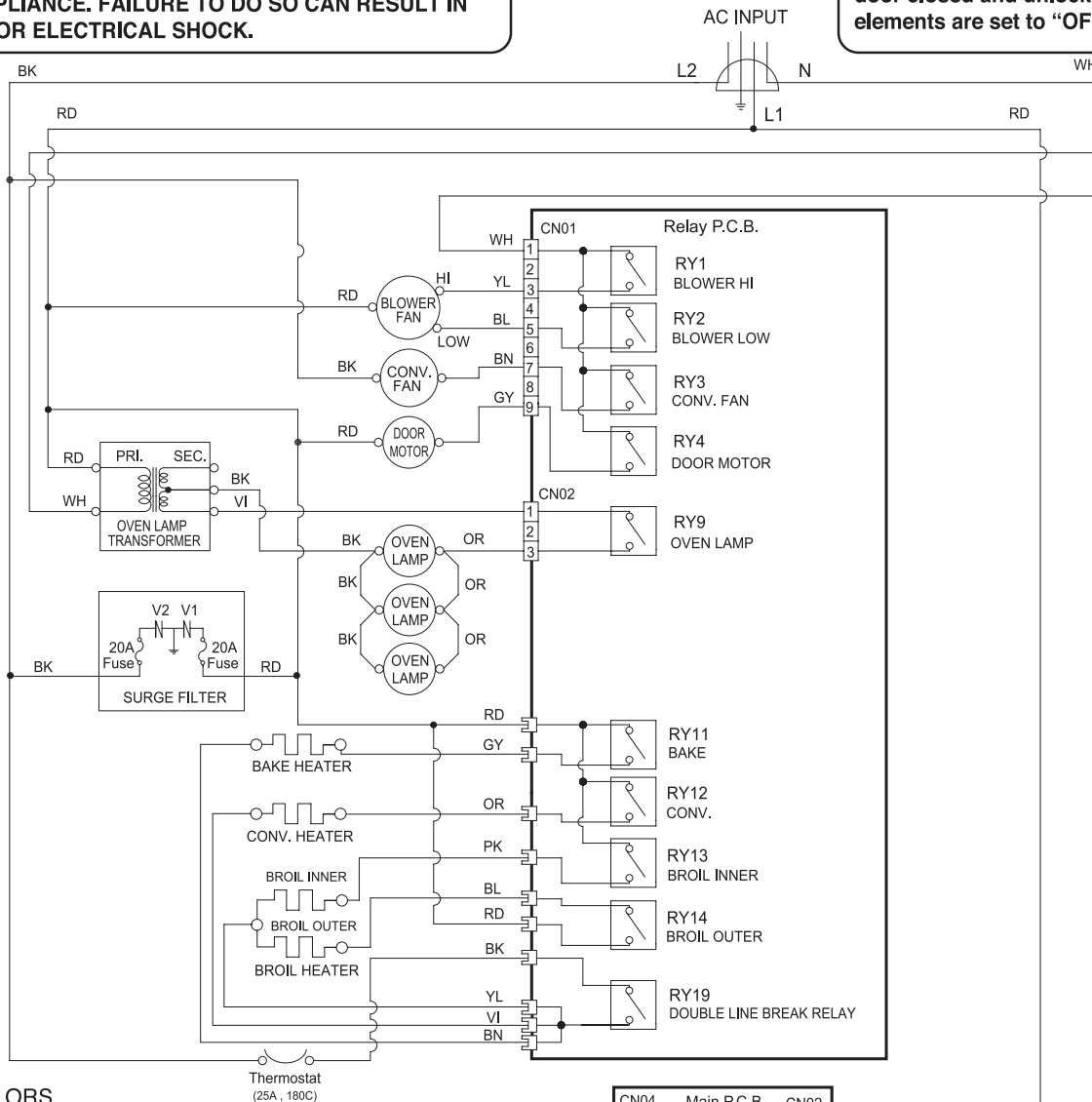

WIRE COLORS

SYMBOL	COLOR
BK	BLACK
RD	RED
WH	WHITE
BN	BROWN
PK	PINK
YL	YELLOW
BL	BLUE
GY	GRAY
GN	GREEN
OR	ORANGE
VI	VIOLET

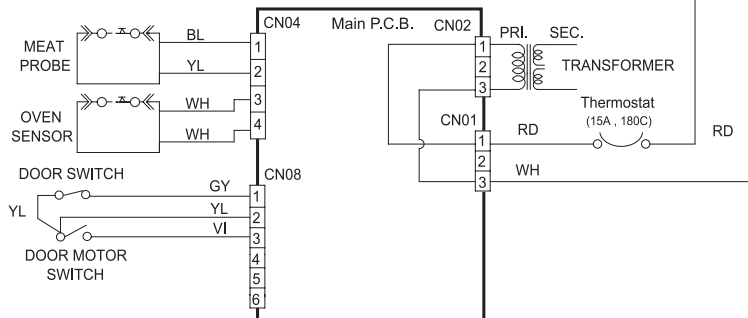

STRIP CIRCUITS

Complete the following steps before checking electric oven circuit :

1. Check the line voltage, household fuse or circuit breaker.
2. Check for loose wiring or mis-wiring within electric range.

NOTE: The following individual circuits are for use in diagnosis, and are shown in the ON position.

Full Broil mode

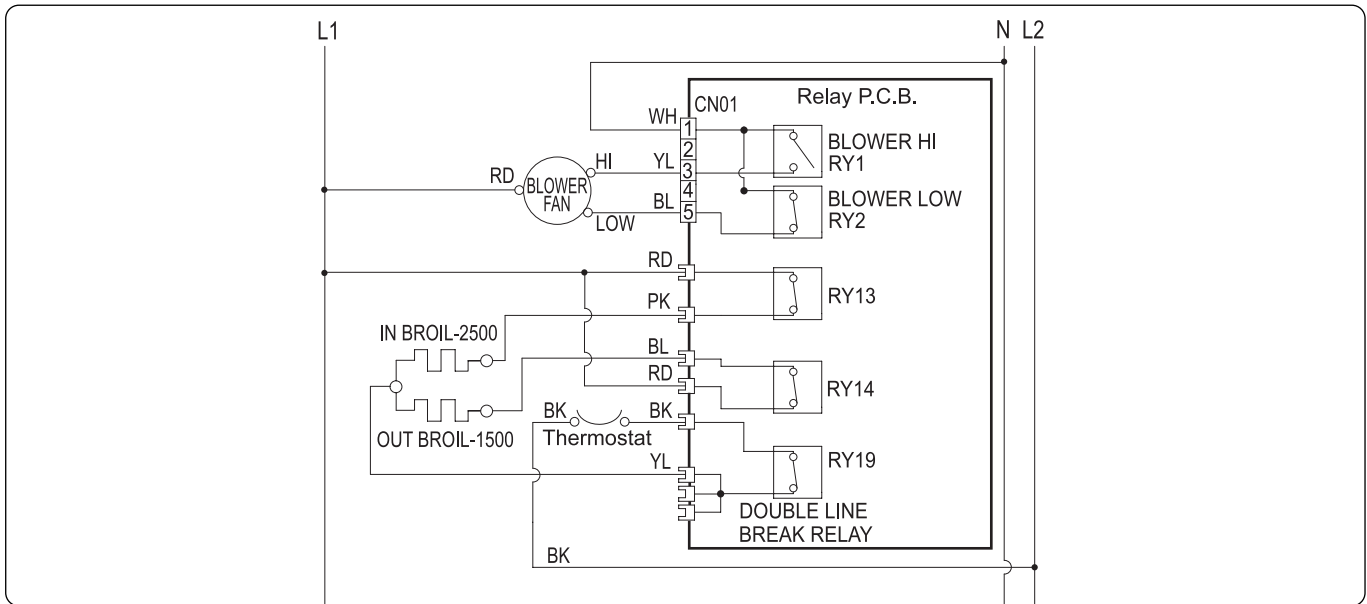

Center Broil mode

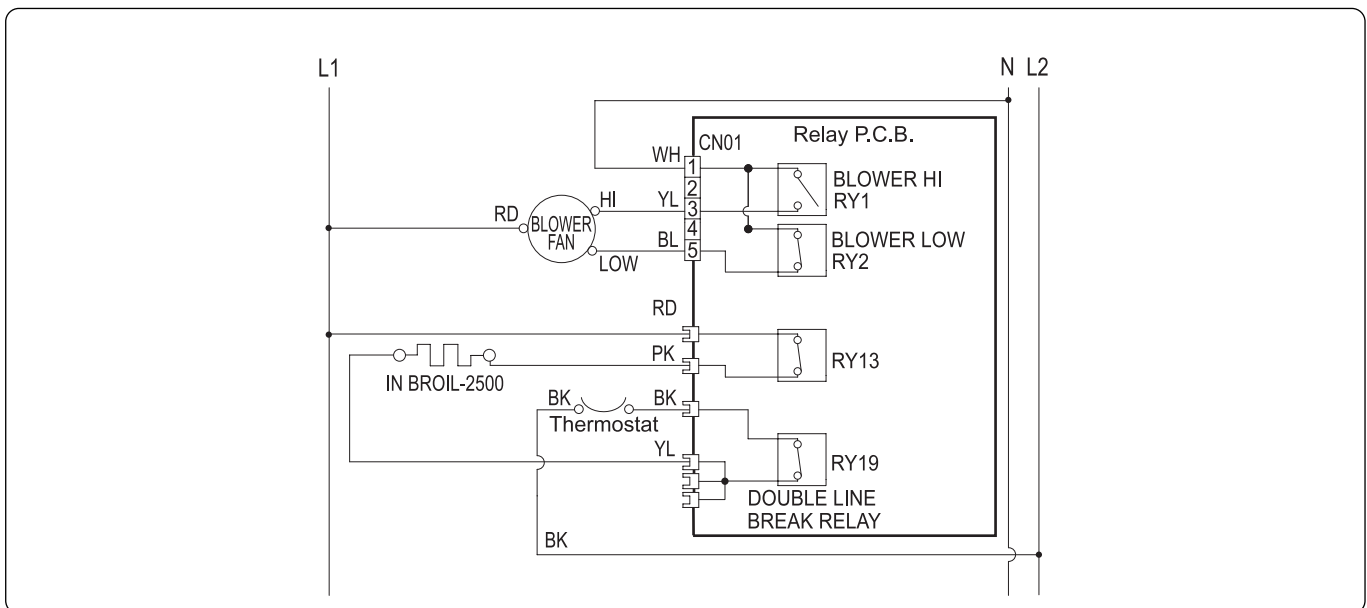

Crisp Convection mode

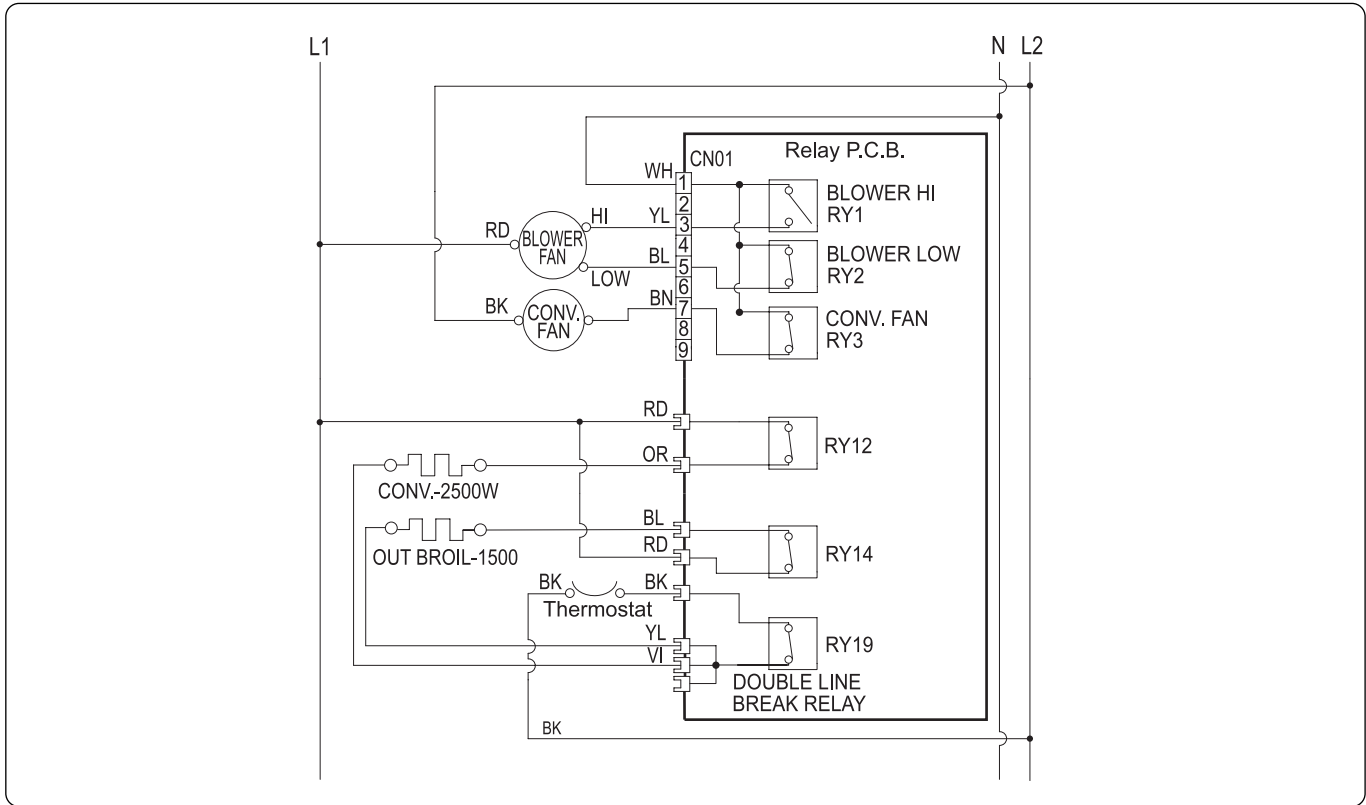

Conv. Bake & Conv. Roast mode

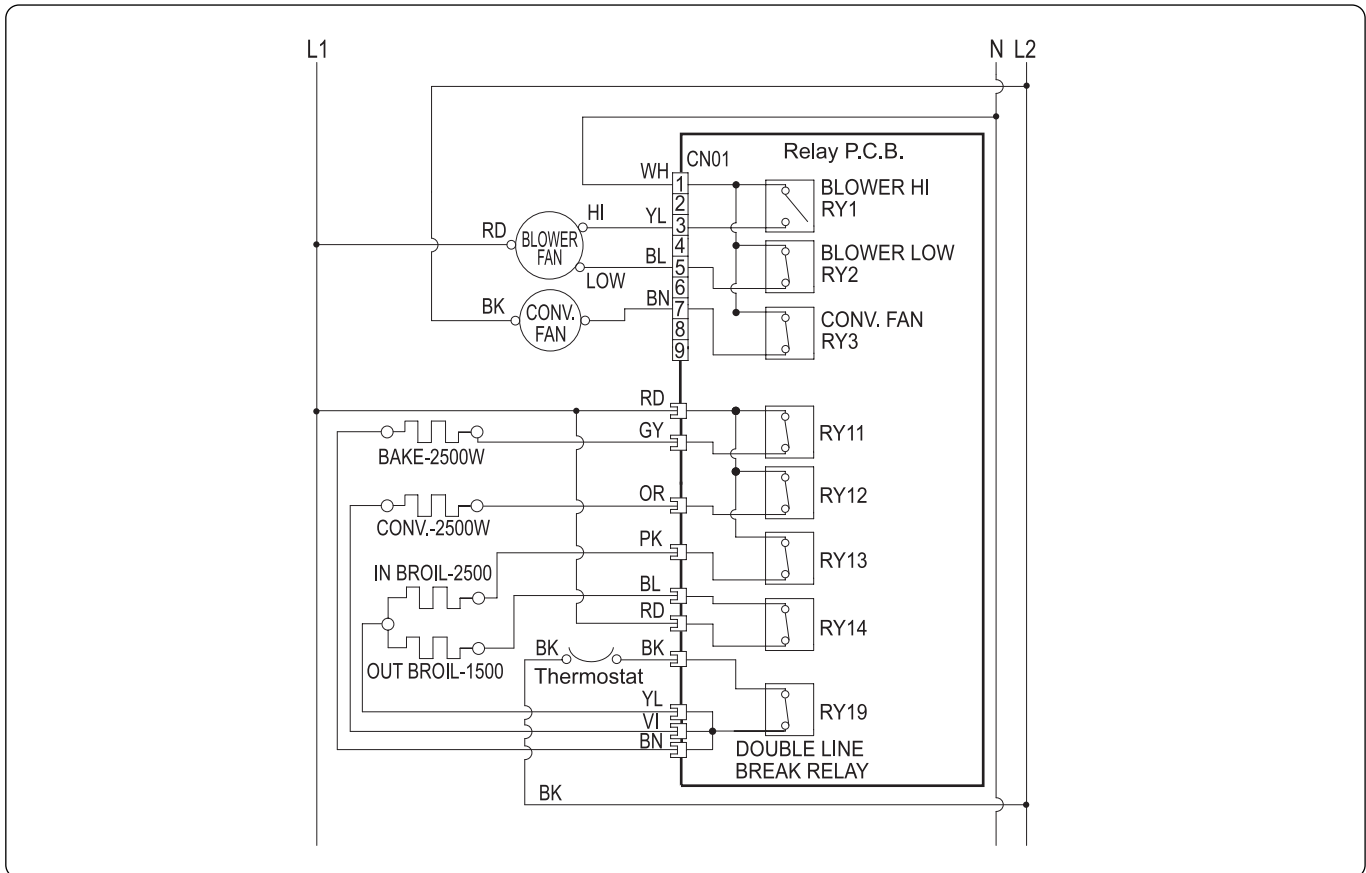

Note: In case of Bake mode, the convection fan will operate only for preheating.

Bake & Roast mode

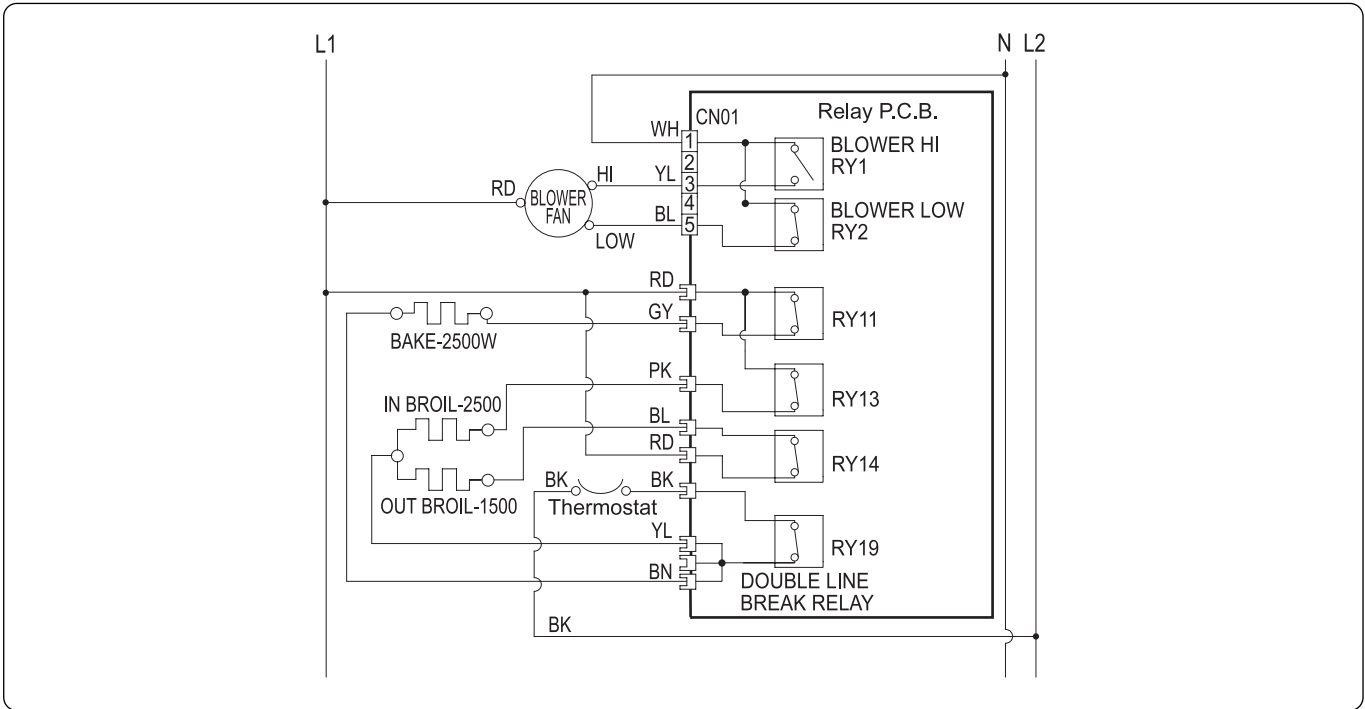

Self Clean mode

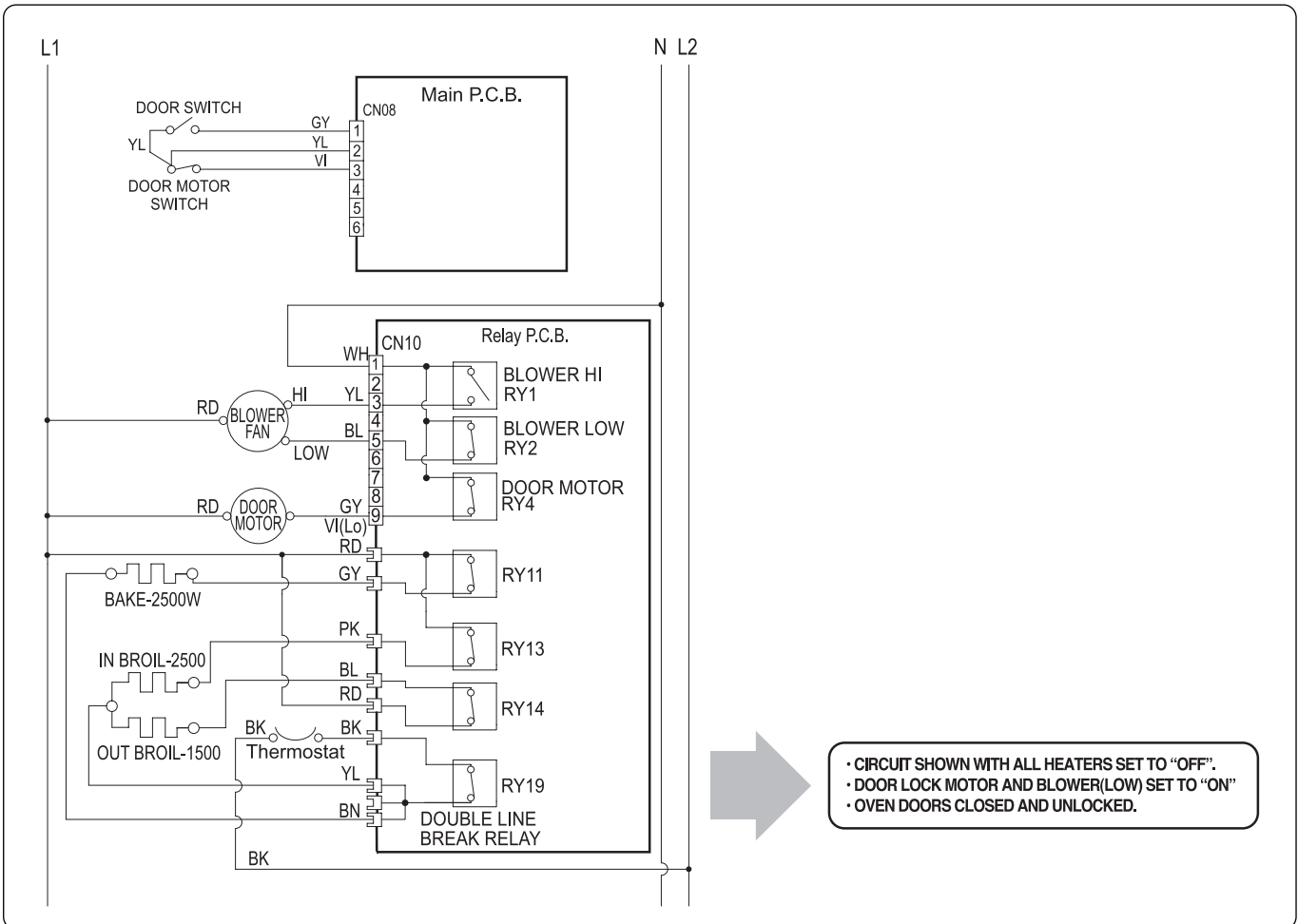

Warm & Proof mode

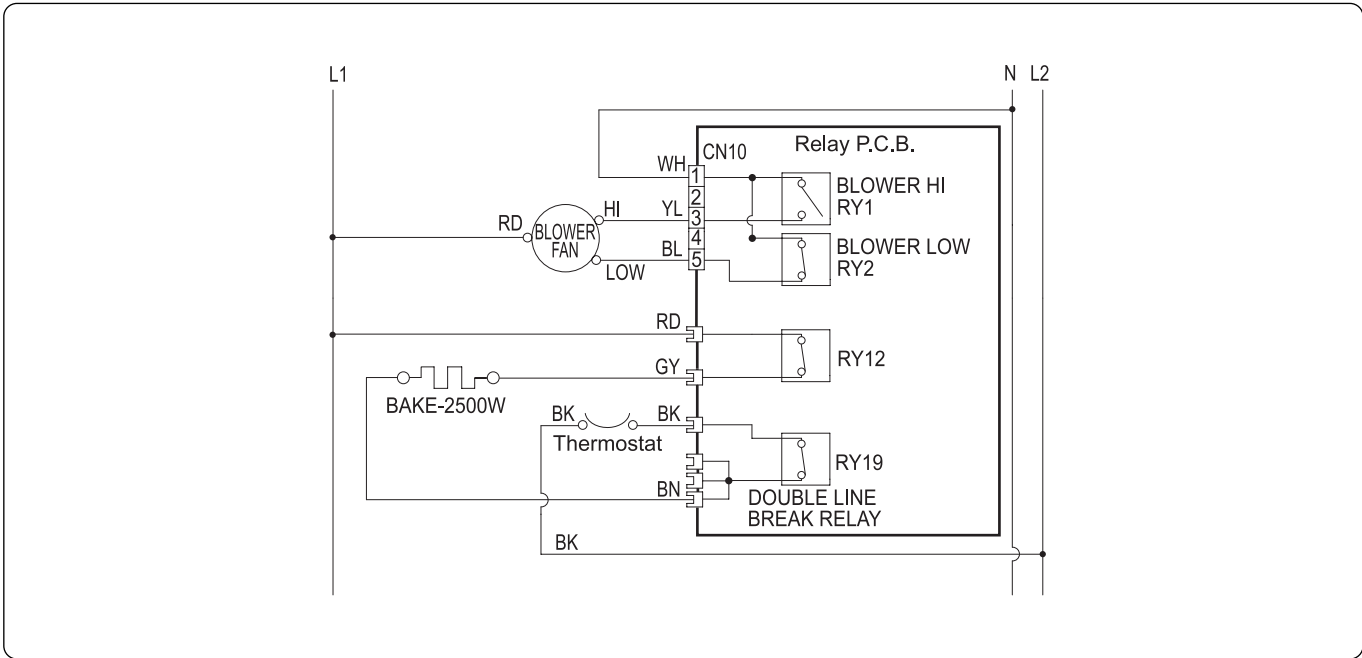

EXPLODED VIEW

INTRODUCTION

MODEL: LSWS305ST

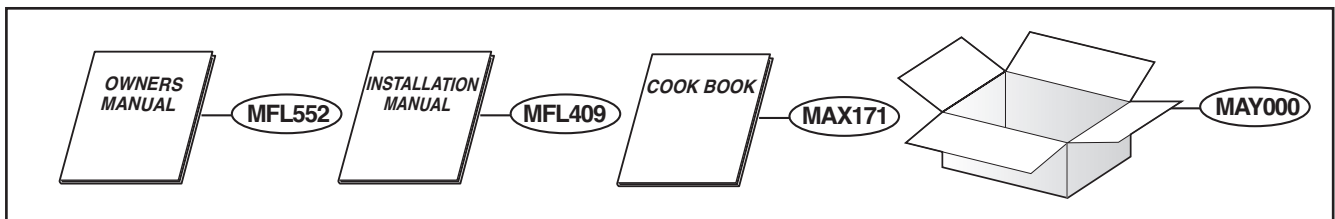
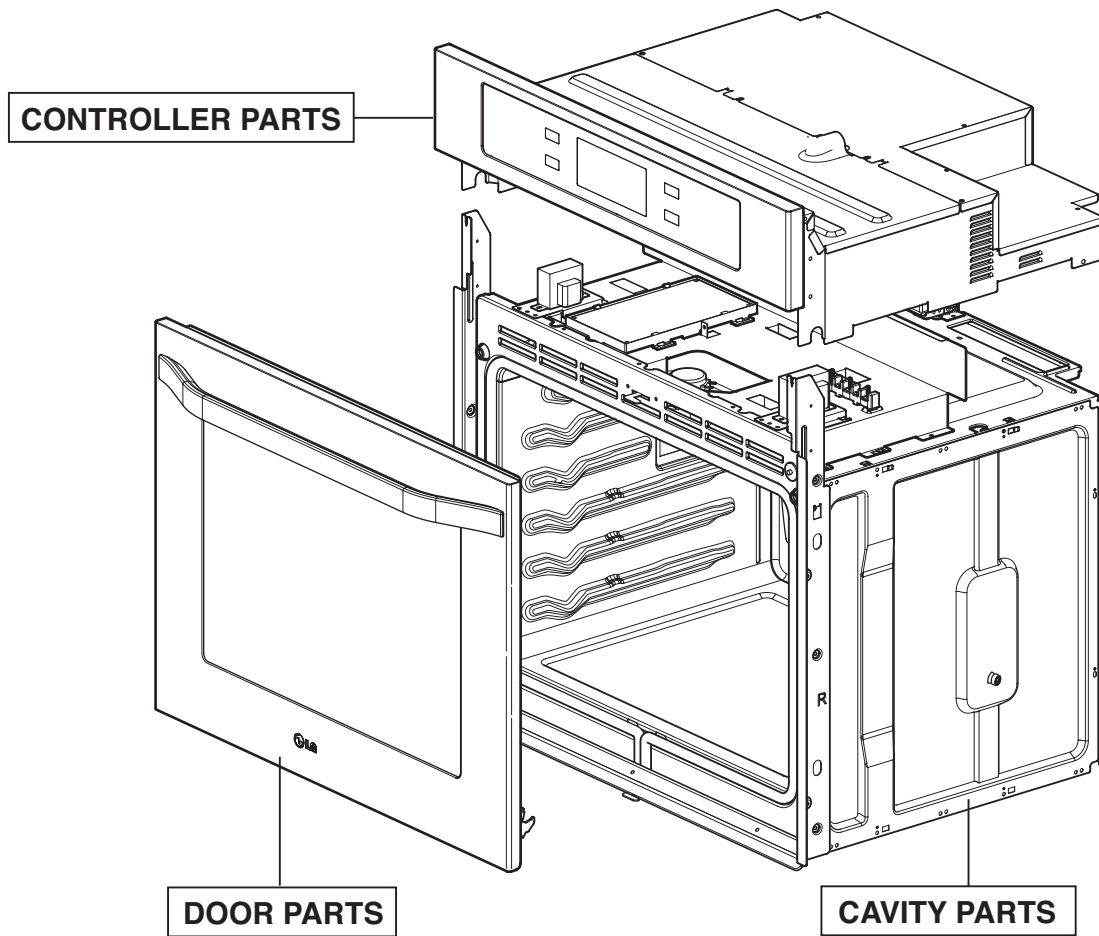

DOOR PARTS

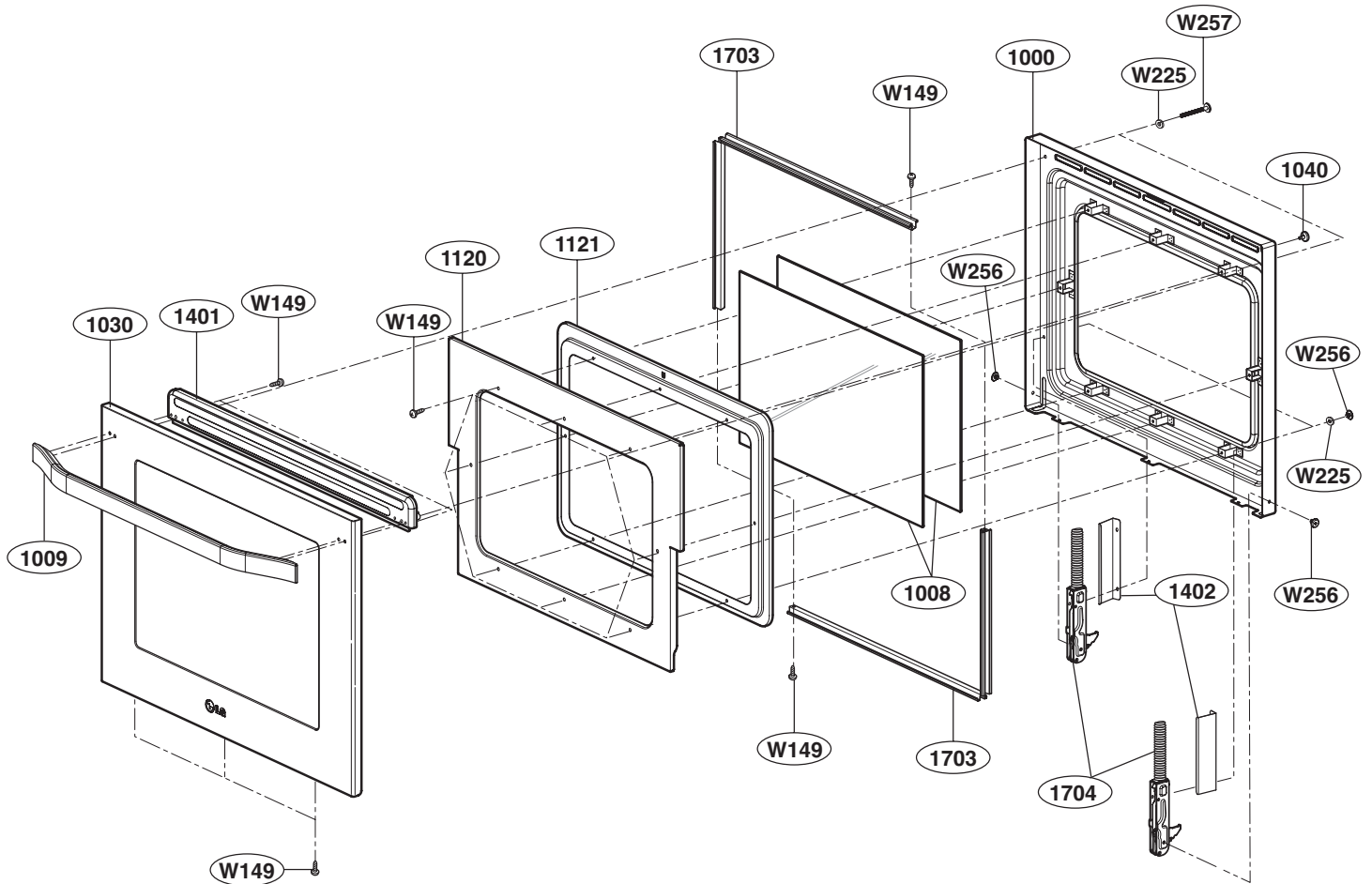

CONTROLLER PARTS

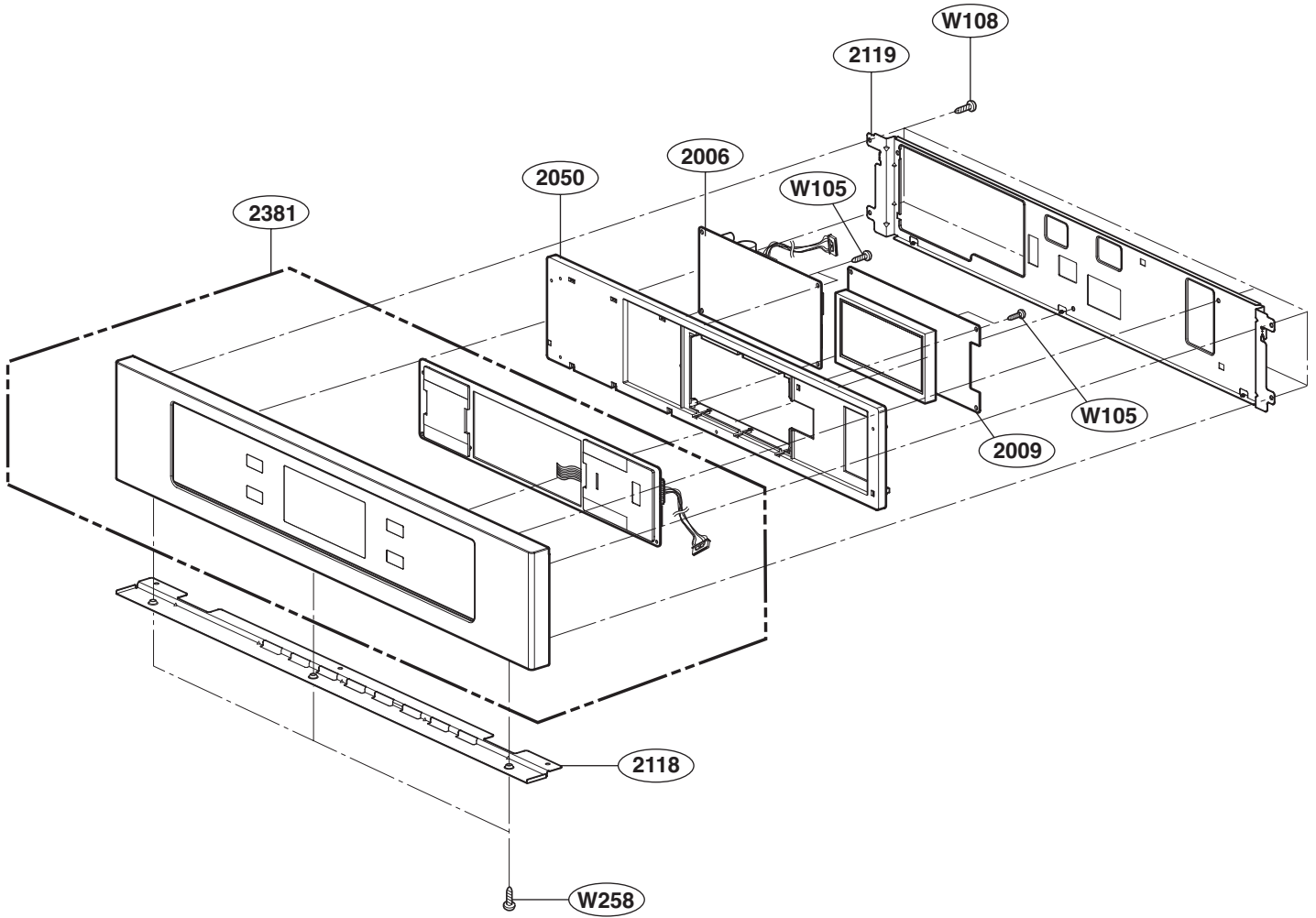

ASSEMBLY

