

This Owner's Manual is provided and hosted by [Appliance Factory Parts](#).

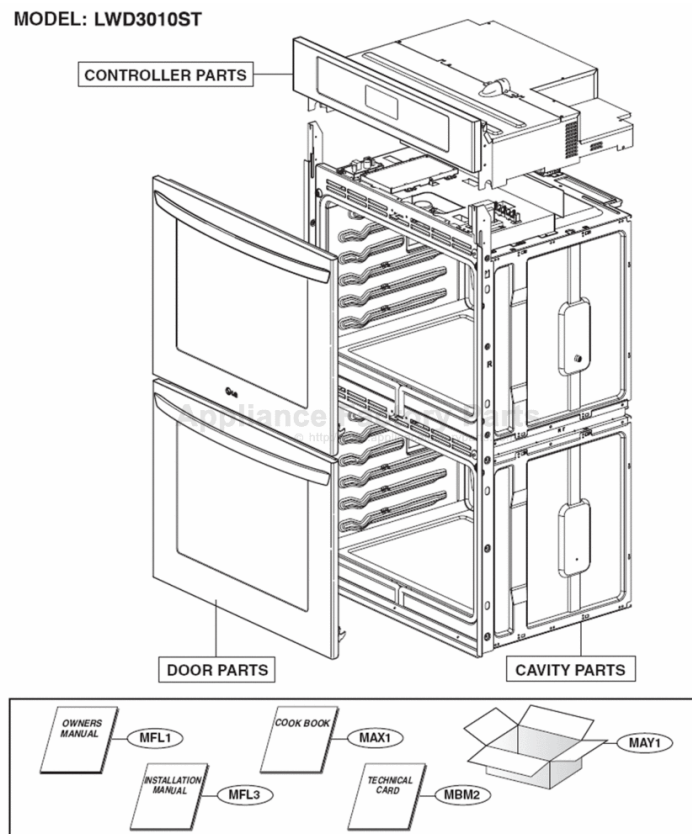

# LG LWD3010ST Owner's Manual

[Shop genuine replacement parts for LG LWD3010ST](#)



[Find Your LG Oven Parts - Select From 10 Models](#)

----- Manual continues below -----



ENGLISH

ESPAÑOL

Français

# INSTALLATION MANUAL ELECTRIC CONVECTION BUILT-IN OVEN

Please read these instructions thoroughly before installing and operating the oven.

LWS3081ST	LSWD305ST
LWD3081ST	LWS3010ST
LSWS305ST	LWD3010ST

P/No.: MFL51224801

[www.lge.com](http://www.lge.com)

**1 BEFORE YOU BEGIN**

Remove all tape and packing materials before using the oven. Dispose all plastic bags after unpacking the oven. Never allow children to play with packing materials.

**IMPORTANT SAFETY INSTRUCTIONS**

Read and follow all instructions before using your oven to prevent the risk of fire, electric shock, injury to person, or damage when using the oven. This guide does not cover all possible conditions that may occur. For further assistance contact your service agent or manufacturer.



This is the safety alert symbol. This symbol alerts you to potential hazards that can kill or hurt you and others. All safety messages will follow the safety alert symbol and either the word "WARNING" or "CAUTION". These words mean :

**WARNING**

This symbol will alert you to hazards or unsafe practices which could cause serious bodily harm or death.

**CAUTION**

This symbol will alert you to hazards or unsafe practices which could cause bodily injury or property damage.

**WARNING**

- **The information in this manual should be followed exactly.**
- A fire or electrical shock may result causing property damage, personal injury or death.
- **DO NOT put any weight on the oven door. Never allow anyone to climb, sit, stand or hang on the oven door.**
- The oven could be tipped and injury might result from food or the oven itself.
- **The electrical power must be shut off while the electrical connections are being made.**
- Failure to do so can result in severe personal injury, death or electrical shock.
- **New branch-circuit installations (1996 NEC), mobile homes, recreational vehicles, or installations where local codes prohibit grounding through the neutral conductor require 4-wire branch-circuit connection.**
- **Improper connection of aluminum house wiring to copper leads can result in an electrical hazard or fire. Use only connectors designed for joining copper to aluminum and follow the manufacturer's recommended procedure closely.**
- **Mounting screws must be used.**
- Failure to do so can result in the oven falling out of the cabinet causing serious injury.

**CAUTION**

- **Make sure the cabinets and wall coverings around the oven can withstand the temperature (up to 194°F[90°C]) generated by the oven.**
- Discoloration, delamination or melting may occur.
- **DO NOT remove spacers on the side walls of the built-in oven.**
- These spacers center the oven in the space provided. The oven must be centered to prevent excess heat buildup that may result in heat damage or fire.
- **DO NOT block the oven air exhaust located at the bottom of the oven.**
- Blocking the exhaust may cause cabinet damage and product malfunction.

**IMPORTANT NOTE**

This installation must be completed by a qualified installer or technician.

- Please read the entire Installation Instructions prior to installation.
- Remove all packing materials from the oven compartments before connecting the electrical supply to the oven.
- Installer: please retain these instructions for local inspector’s reference, then leave them with the consumer.
- Consumer: please read and keep these instructions for future reference and be sure to read the entire OWNER’S MANUAL prior to use.

**WARNING**

• **The information in this manual should be followed exactly.**

- A fire or electrical shock may result causing property damage, personal injury or death.

**IMPORTANT NOTE**

Proper installation is the responsibility of the installer and product failure due to improper installation is NOT covered under warranty.

**WARNING**

• **DO NOT put any weight on the oven door. Never allow anyone to climb, sit, stand or hang on the oven door.**

- The oven could tip and injury might result from food or the oven itself.

**WARNING**

• **The electrical power must be shut off while the electrical connections are being made.**

- Failure to do so can result in severe personal injury, death or electrical shock.

**IMPORTANT NOTE**

Observe all governing codes and ordinances. This appliance must be properly grounded.

**PREPARE TO INSTALL THE OVEN**



Phillips Screwdriver

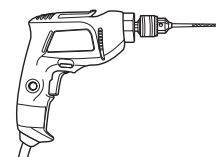

Drill

**PREPARE TO INSTALL THE OVEN**

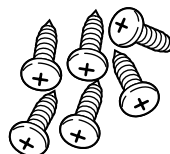

6 Screws For Bottom Trim  
(3 needed for installation and 3 extra’s)

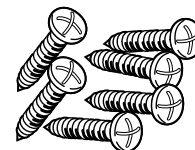

6 Wood Screws For Mounting  
(4 needed for installation and 2 extra’s)



30" (76.2 cm)  
Metal Bottom Trim

**MATERIALS NEEDED**

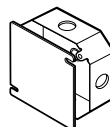

Junction Box



Wire Nuts

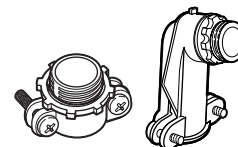

3/4" Conduit Connector



36" (91 cm)  
of String

## 1 INSTALLATION DRAWINGS (FOR 30" SINGLE BUILT-IN OVEN)

The first step of your installation should be to measure your current cutout dimensions and compare them to the cutout dimensions shown below. You may find little or no cabinet work will be necessary.

### IMPORTANT NOTE

- The cabinet base platform must be able to support 190lbs (86Kg). If the cabinet does not have a solid bottom, two braces or runners must be installed level with the bottom of the cutout to support the weight of the oven. Make sure the base is level and front of cabinet is square. If the cabinet base is not level, the oven glides will tend to slide out when opening the door.
- If marks, blemishes or the cutout opening are visible above the installed oven, it may be necessary to add wood shims under the runners and front trim until the marks or opening are covered.
- If the cabinet does not have a front frame and the sides are less than 3/4" (1.9 cm) thick, shim both sides equally to establish the cutout width.
- The junction box must be flush with the rear wall of the cabinet as shown below.
- Allow at least 23" clearance for door depth when it is open.

### Product dimensions

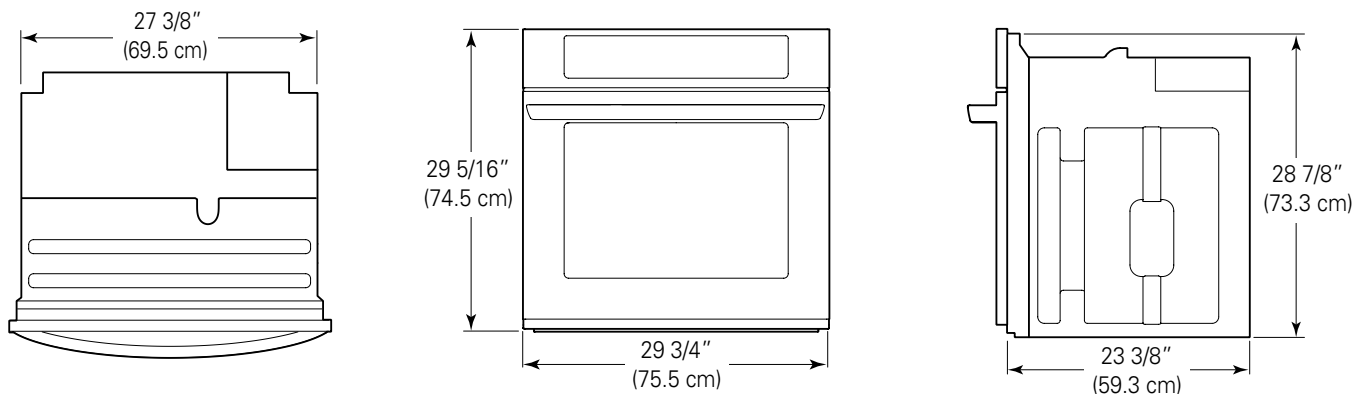

### Cutout dimensions

Cabinet Width	30" (762 mm)
Recommended Minimum Cutout location from floor	31" (787.4 m)
Cutout Depth	23 1/2" Min. (596.9 mm)
Cutout Width	28 1/2" Min. (723.9 mm) 28 5/8" Max. (727 mm)
Cutout Height	28 15/16" Min. (735 mm) 29" Max. (736.6 mm)

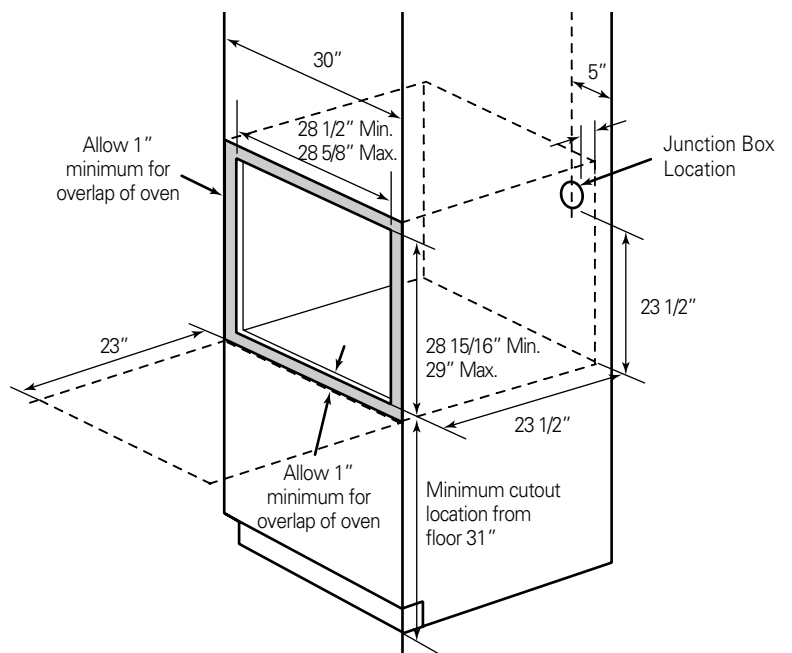

**2 INSTALLATION DRAWINGS (FOR 30" DOUBLE BUILT- IN OVEN)**

The first step of your installation should be to measure your current cutout dimensions and compare them to the cutout dimensions shown below. You may find little or no cabinet work will be necessary.

**IMPORTANT NOTE**

- The cabinet base platform must be able to support 325lbs (147Kg). If the cabinet does not have a solid bottom, two braces or runners must be installed level with the bottom of the cutout to support the weight of the oven. Make sure the base is level and front of cabinet is square. If the cabinet base is not level, the oven glides will tend to slide out when opening the door.
- If marks, blemishes or the cutout opening are visible above the installed oven, it may be necessary to add wood shims under the runners and front trim until the marks or opening are covered.
- If the cabinet does not have a front frame and the sides are less than 3/4" (1.9 cm) thick, shim both sides equally to establish the cutout width.
- The junction box must be flush with the rear wall of the cabinet as shown below.
- Allow at least 23" clearance for door depth when it is open.

**Product dimensions**

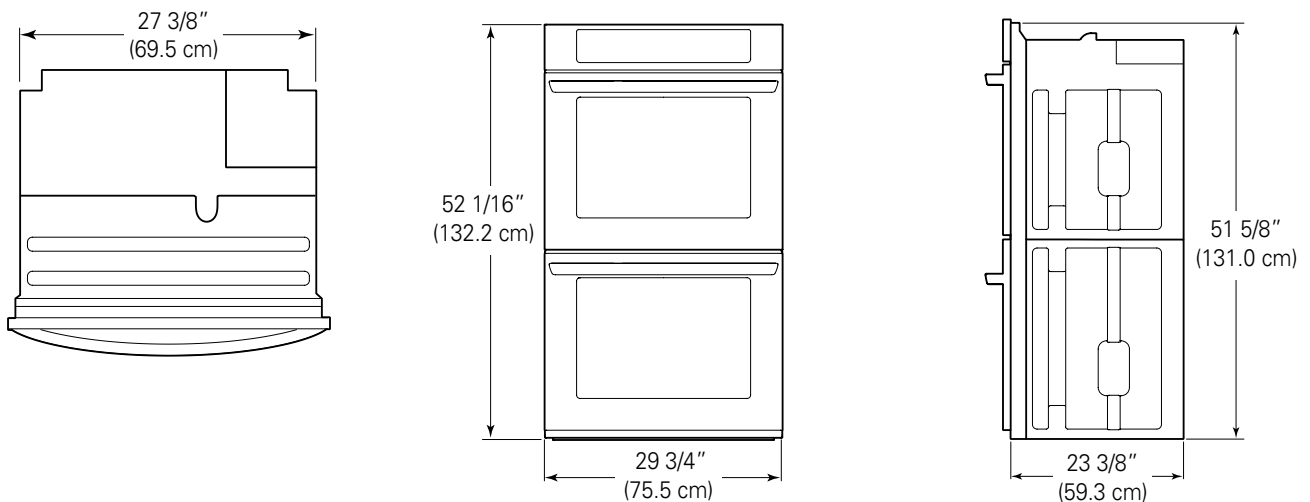

**Cutout dimensions**

Cabinet Width	30" (762 mm)
Recommended Minimum Cutout location from floor	12" (304.8 mm)
Cutout Depth	23 1/2" Min. (596.9 mm)
Cutout Width	28 1/2" Min. (723.9 mm) 28 5/8" Max. (727 mm)
Cutout Height	51 13/16" Min. (1316 mm) 51 15/16" Max. (1319.2 mm)

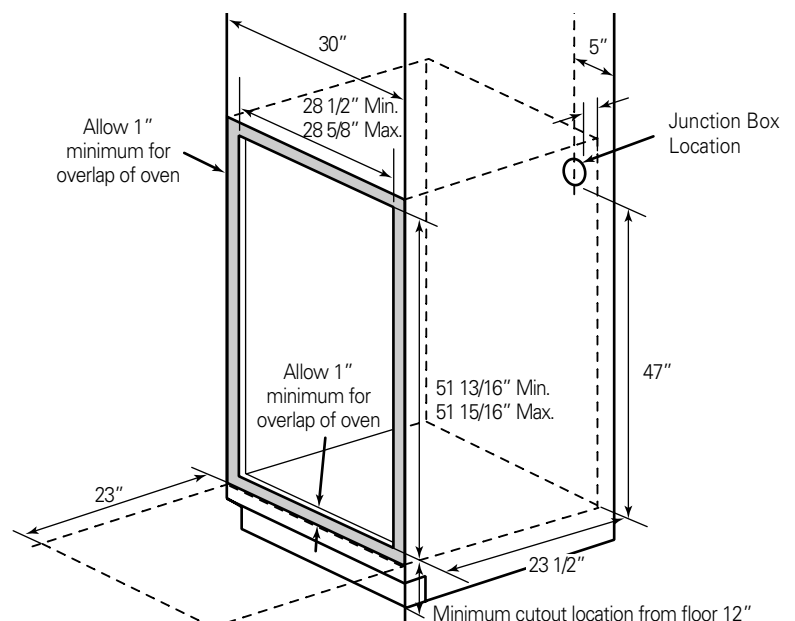

**3 INSTALLATION DRAWINGS (FOR 30" SINGLE BUILT- IN OVEN UNDERCOUNTER)**

The first step of your installation should be to measure your current cutout dimensions and compare them to the cutout dimensions shown below. You may find little or no cabinet work will be necessary.

**IMPORTANT NOTE**

- The cabinet base platform must be able to support 190lbs (86Kg). If the cabinet does not have a solid bottom, two braces or runners must be installed level with the bottom of the cutout to support the weight of the oven. Make sure the base is level and front of cabinet is square. If the cabinet base is not level, the oven glides will tend to slide out when opening the door.
- If marks, blemishes or the cutout opening are visible above the installed oven, it may be necessary to add wood shims under the runners and front trim until the marks or opening are covered.
- If the cabinet does not have a front frame and the sides are less than 3/4" (1.9 cm) thick, shim both sides equally to establish the cutout width.
- The junction box must be flush with the rear wall of the cabinet as shown below.
- This oven is only approved to be installed under the specific models as labeled on this unit.

**Product dimensions**

Dimensions are same as the single built-in oven on page 4.

**Cutout dimensions**

Gas or electric cooktops may be installed over this oven.  
See cooktop installation instructions for cutout size.  
See label on top of oven for approved cooktop models.

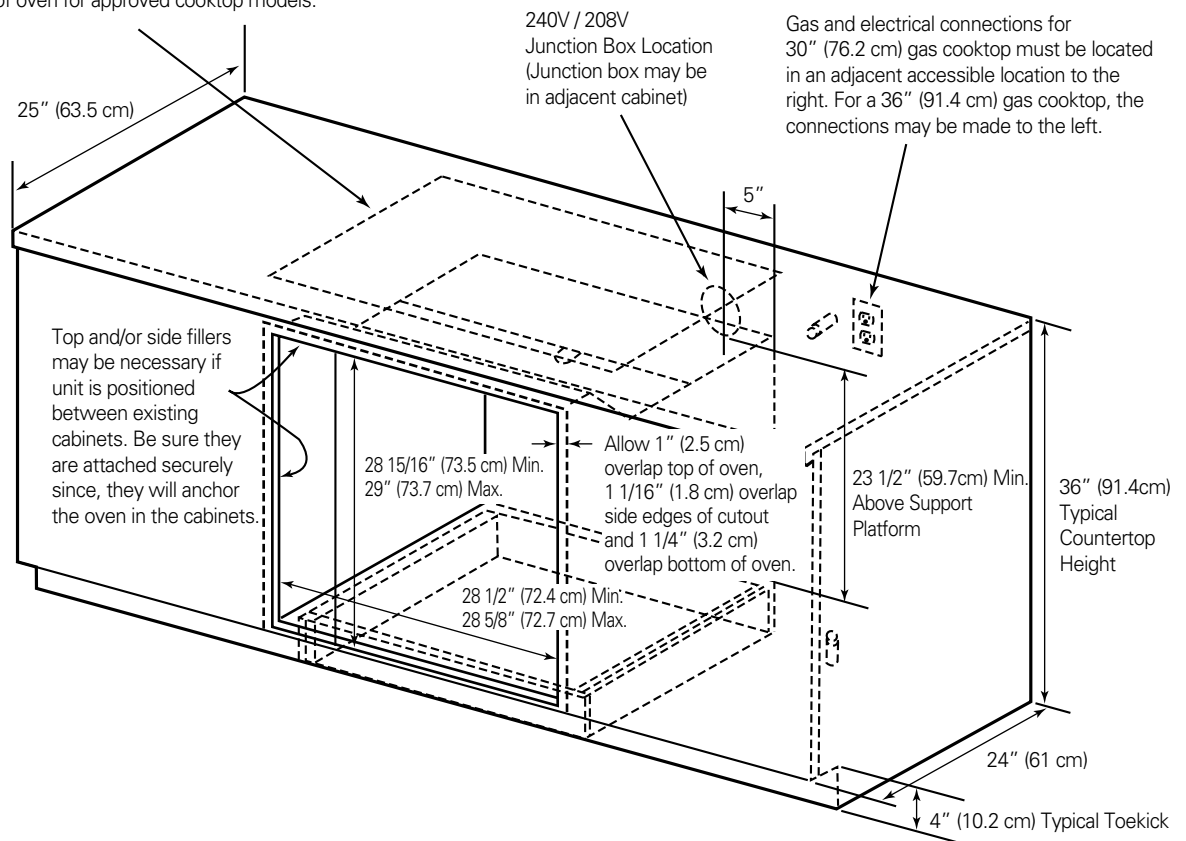

#### 4 PREPARATION FOR MOVING THE OVEN

The second step of your installation should be to remove any packing material from the oven before you install the oven.

1. Remove all tape from around the oven.
2. Open the oven door and remove packaging materials and oven racks inside the oven.
3. Door removal is not a requirement for installation of the oven, but is an added convenience.  
To remove the door, follow the steps below.

##### Step. 1

Fully open the door.

##### Step. 2

Pull the hinge locks down toward (Fig.1) the door frame, to the unlocked position.

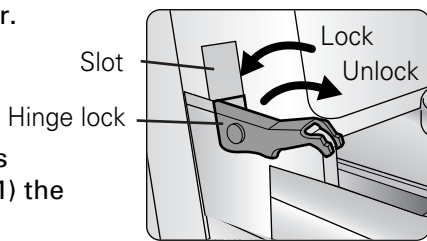

<Fig.1>

##### Step. 3

Firmly grasp both sides of the door at the top.

##### Step. 4

Close door to the door removal position, which is approximately 5 degrees. (refer to the Fig.2)

##### Step. 5

Lift door up and out until the hinge arm is clear of the slot.

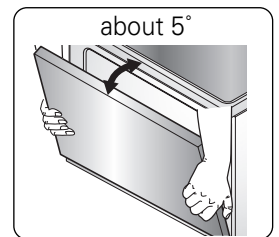

<Fig.2>

4. Place the oven on a table or platform even with the cutout opening. (table or platform must support **190lbs [86Kg] for a single built-in oven, 325lbs [147Kg] for a double built-in oven.**)
5. Remove the metal bottom trim from the oven. It will be installed at the end of the installation process. The trim is wrapped separately and taped to the top of the unit.

#### CAUTION

- **Make sure the cabinets and wall coverings around the oven can withstand the temperature (up to 194°F[90°C]) generated by the oven.**
- Discoloration, delamination or melting may occur.

#### CAUTION

- **DO NOT remove spacers on the side walls of the built-in oven.**
- These spacers center the oven in the space provided. The oven must be centered to prevent excess heat buildup that may result in heat damage or fire.

#### IMPORTANT NOTE

- Do not lift the door by the handle.
- The oven door is very heavy. Be sure you have a firm grip before lifting the oven door off the hinges. Use caution when lifting. It is recommended that two people lift and position the oven into the cabinet opening. Failure to follow this instruction can result in back or other injury. Wear gloves to protect hands from any sharp edges.
- Do not lay the oven door on its handle. This may cause dents or scratches.

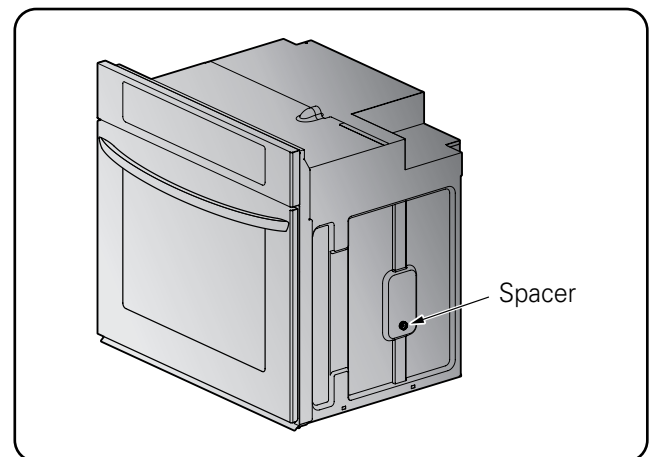

**1 ELECTRICAL CONNECTION REQUIREMENTS**

The third step of your installation should be to follow electrical connection requirements below. Dedicated circuit protection must be prepared as recommended in electrical connection requirements and the oven should be grounded properly.

**IMPORTANT NOTE**

- Be sure your wall oven is installed and grounded properly by a qualified installer or service technician.
- This wall oven must be electrically grounded in accordance with local codes or, in their absence, with the National Electrical Code ANSI/NFPA No.70- latest edition\* in United States, or with CSA Standard C22.1-1982 and C22.2 No.01982 (or latest edition)\*\*, Canadian Electrical Code, Part1, and all local codes and ordinances.
  - This wall oven must be supplied with the proper voltage and frequency, and connected to an individual, properly grounded branch circuit, protected by a circuit breaker or fuse. To know the circuit breaker or fuse required by this model, see the rating plate to find the wattage consumption and refer to table below to get the circuit breaker or fuse amperage.

Appliance Rating Watts 240V	Protection Circuit recommended	Appliance Rating Watts 208V	Protection Circuit recommended
less than 4800W	20A	less than 4100W	20A
4800W - 7200W	30A	4100W - 6200W	30A
7200W - 9600W	40A	6200W - 8300W	40A
9600 and +	50A	8300 and +	50A

- A double wall oven can consume up to 7,800W at 240VAC.  
A 40Amp circuit breaker with wire gauge #8 AWG must be used.
- A single wall oven can consume up to 4,100W at 240VAC.  
A 30Amp circuit breaker with wire gauge at least #10 AWG must be used.

**IMPORTANT NOTE**

- Do Not ground to a gas pipe.
- Do Not have a fuse in the neutral or grounding circuit.
- A U.L.-listed conduit connector must be provided at the junction box.

**⚠ WARNING**

- **New branch-circuit installations (1996 NEC), mobile homes, recreational vehicles, or installations where local codes prohibit grounding through the neutral conductor require 4-wire branch-circuit connection.**

**⚠ WARNING**

- **Improper connection of aluminum house wiring to copper leads can result in an electrical hazard or fire. Use only connectors designed for joining copper to aluminum and follow the manufacturer’s recommended procedure closely.**

**2 ELECTRICAL CONNECTION**

The fourth step of your installation should be to prepare the electrical connection as follows:

1. Turn off the circuit breaker or remove fuses to the oven branch circuit.
2. With the oven positioned directly in front of the cabinet opening, connect the flexible conduit to the electrical junction box as shown below. Position the conduit in such a manner that it will lie on top of the oven in a natural loop when the oven is installed.

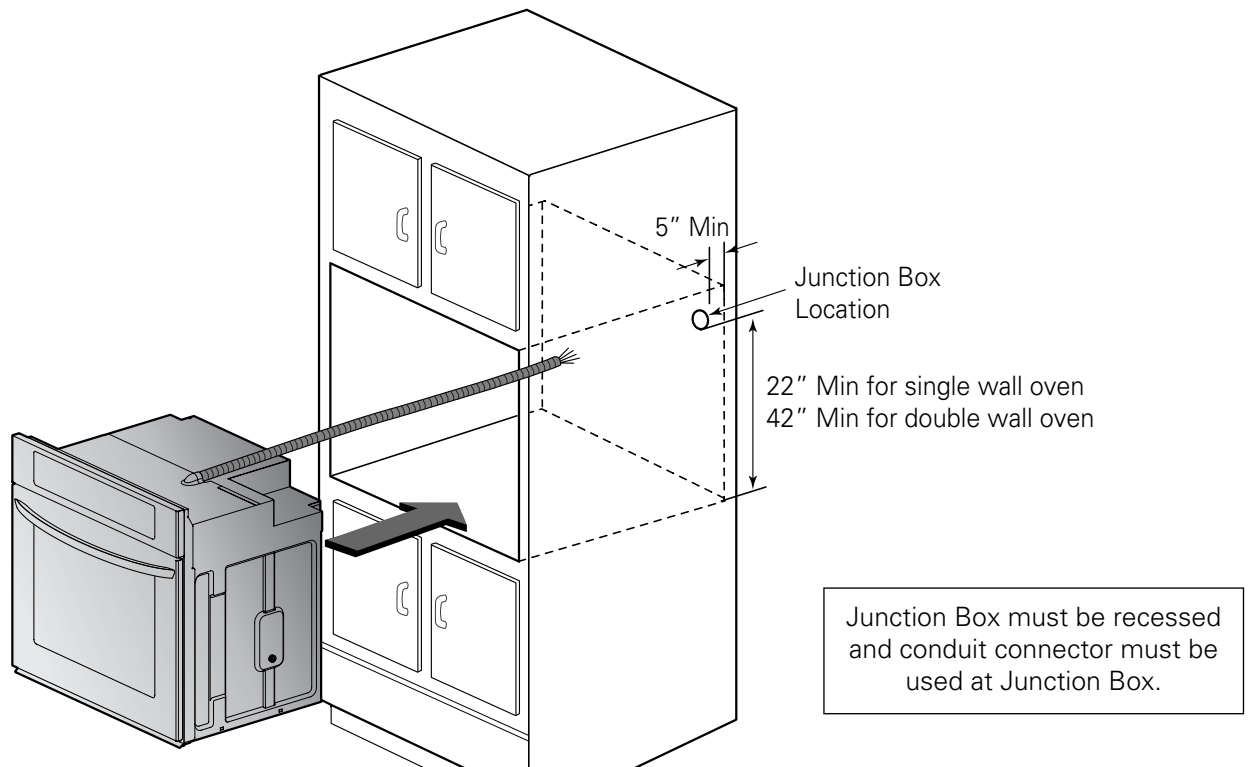

3. If local codes permit connection of the frame grounding conductor to the neutral(white) wire, follow the instruction of 3-wire circuit connection on page 10.  
If used in mobile homes or new construction, or recreational vehicle, or local codes do not permit connection of the frame grounding conductor to the neutral(white) wire, follow the instruction of 4-wire circuit connection on page 10.

**IMPORTANT NOTE**

- The wall ovens must be hard wired (direct wired) into an approved junction box. A plug and receptacle is not permitted on these products.
- DO NOT shorten the flexible conduit. The conduit connector must be securely attached to the junction box and the flexible conduit must be securely attached to the conduit connector. If the flexible conduit will not fit within the connector, do not install the oven until a connector of the proper size is obtained.

**NOTE TO ELECTRICIAN**

The power leads supplied with the appliance are UL, CSA recognized for connection to larger gauge household wiring. The insulation of these leads is rated at temperatures much higher than the temperature rating of household wiring. The current carrying capacity of the conductor is governed by the wire gauge and the temperature rating of the insulation around the wire.

## IMPORTANT NOTE

- You will need to purchase an appropriate conduit connector to complete the connection of the conduit to the junction box.

### 3-wire circuit connection

To connect to a three-wire circuit, follow these steps:

1. Connect the oven ground (green) wire and neutral (white) wire to the branch circuit neutral (white or gray in color) wire, using a wire nut.
2. Connect the oven red wire to the branch circuit red (L2) wire in accordance with local codes, using a wire nut.
3. Connect the oven black wire to the branch circuit black (L1) wire in accordance with local codes, using a wire nut. If the residence red, black or white wires are aluminum conductors, see WARNING on page 8.
4. Install the junction box cover.

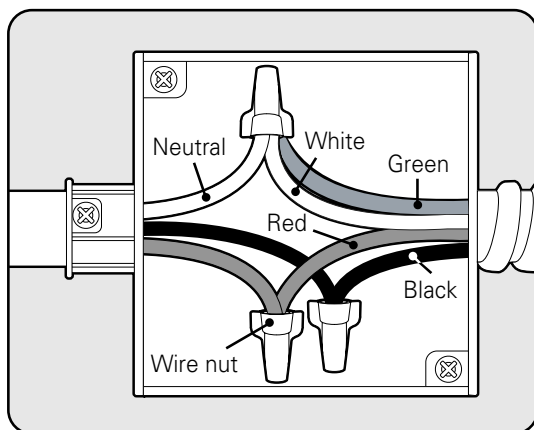

Junction Box

### 4-wire circuit connection

To connect to a four-wire circuit, follow these steps:

1. Separate the oven ground and white wires if necessary.
2. Connect the oven ground (green) wire to the branch circuit ground (green) wire in accordance with local codes, using a wire nut. If the residence red, black or white wires are aluminum conductors, see WARNING on page 8.
3. Connect the oven white wire to the branch circuit neutral (white or gray in color) wire in accordance with local codes, using a wire nut.
4. Connect the oven red wire to the branch circuit red (L2) wire in accordance with local codes, using a wire nut.
5. Connect the oven black wire to the branch circuit black (L1) wire in accordance with local codes, using a wire nut. If the residence red, black or white wires are aluminum conductors, see WARNING on page 8.
6. Install the junction box cover.

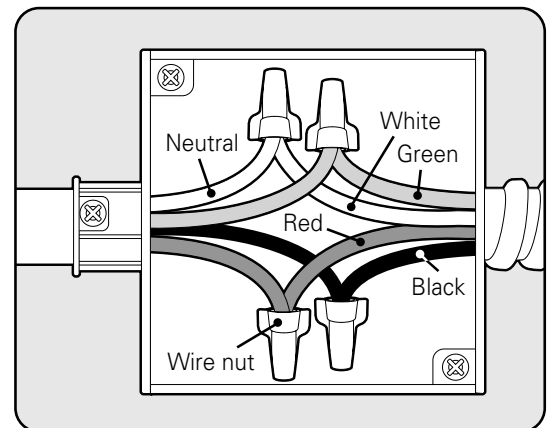

Junction Box

**1 CABINET INSTALLATION**

The fifth step of your installation should be to install the oven into the cabinet as follows:

1. Sliding the oven into the opening.
  - a. Loop (do not tie) a 36" (91cm) string around the conduit before the oven is slid into place. This will keep the conduit from falling behind the oven.
  - b. Lift oven into cabinet cutout using the oven opening as a grip. Carefully push against the oven front frame. Do not push against outside edges.
  - c. As you slide the oven back, pull the string so that the conduit will lie on the top of the oven in a natural loop.
  - d. When you are sure the conduit is out of the way, slide the oven 3/4 way back into the opening. Remove the string by pulling on one end of the loop.

**CAUTION**

- **DO NOT block the oven air exhaust located at the bottom of the oven.**
- Blocking the exhaust may cause cabinet damage and product malfunction.

**WARNING**

- **Mounting screws must be used.**
- Failure to do so can result in the oven falling out of the cabinet causing serious injury.

2. Securing the oven.
  - a. Using the mounting holes on the oven side trim as a guide, drill pilot holes for screws provided (For securing the double wall oven, use a minimum of 4 screws, one on each side in both the upper and lower ovens. For securing the single wall oven, use a minimum of 2 screws, one on each side.)
  - b. Secure the oven to cabinet with screws provided. If the cabinet is particle board, you must use 3/4" particle board screws. These may be purchased at any hardware store.
3. Installing the metal bottom trim.
  - a. Place the metal bottom trim centered over the pre drilled mounting holes on the lower base.
  - b. Using 3 screws provided, secure the bottom trim to the bottom edge of the cabinet.
4. Reinstalling the oven door.

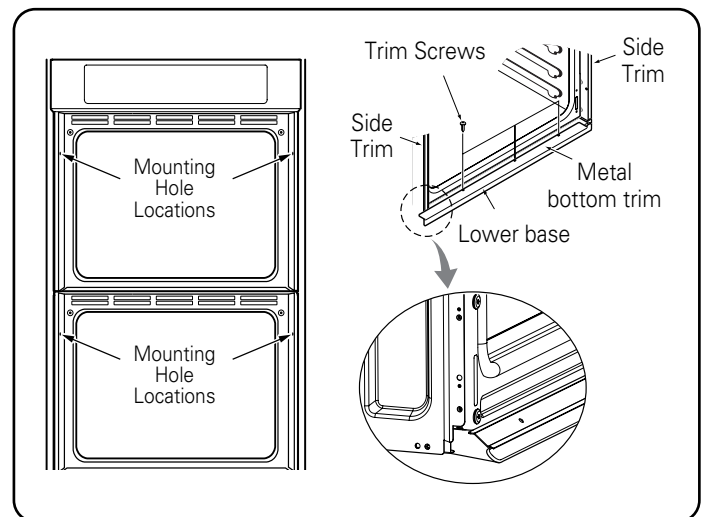
**Step. 1**

Firmly grasp both sides of the door at the top.

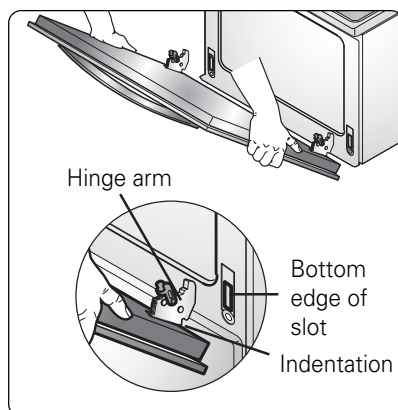
**Step. 2**

With the door at the same angle as the removal position, seat the indentation of the hinge arm into the bottom edge of the hinge slot. The notch in the hinge arm must be fully seated into the bottom of the slot.

**Step. 3**

Fully open the door. If the door will not fully open, the indentation is not seated correctly in the bottom edge of the slot.

**Step. 4**

Push the hinge locks up against the front frame of the oven cavity to the locked position.

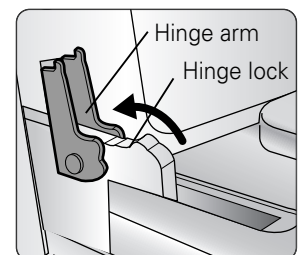
**Step. 5**

Close the oven door.

**1 CHECKING OPERATION**

Each of the functions has been factory checked before shipping. However, it is suggested that you verify the operation of the oven once more. Refer to the Owner's Manual. Follow the instructions for the basic check.

1. Turn on power supply. The initial signal sound will be heard and LG logo should be appear in the display.
2. Check the operation of the broil mode. When the oven is set to broil, the upper element in the oven should become red. After few minutes, partially open the oven door. You should feel heat from the oven. Press the "CLEAR/OFF" pad.
3. Check the operation of the bake mode. After setting the oven to 350°F/177°C for baking, the temperature of the oven in the display should increase. Press the "CLEAR/OFF" pad.
4. Check the operation of the convection bake mode. After setting the oven to 350°F/177°C for convection baking, the fan inside the oven should come on with the door closed. Press the "CLEAR/OFF" pad.
5. Turn on and off the oven light to check the lights are normal condition.
6. Check the operation of the furnace convection mode. After setting the oven to 350°F/177°C for the furnace convection mode, the back element should light up and the fan inside the oven should come on with door closed.

**IMPORTANT NOTE**

- A small amount of smoke and odor may be noticed during the initial break-in period.
- If your oven does not operate properly or an "F", followed by a number, appears in the display, see your Owner's Manual for troubleshooting list. The list includes common occurrences that are not the result of defective workmanship or materials in this product. If the problem occurs continuously, contact your dealer.
- Refer to the warranty in your Owner's Manual for our tool-free service number and address.



**LG Customer Information Center**

1-800-243-0000 USA, Consumer User  
1-888-865-3026 USA, Commercial User  
1-888-542-2623 CANADA

**Register your product Online!**

[www.lg.com](http://www.lg.com)