

This Owner's Manual is provided and hosted by [Appliance Factory Parts](#).



LG FTK130SS Owner's Manual

[Shop genuine replacement parts for LG FTK130SS](#)



[Find Your LG Microwave Parts - Select From 955 Models](#)

----- Manual continues below -----

FTK-127/130 Built-In Trim Kit Installation Instructions

For use with the following microwave oven ACM2160A and UMC5200AA

Proper installation is the installer's responsibility!
Write the model & serial numbers on the owner's manual.
The model number label is located on the oven front.

UL Listed-For use over electric heat source models (Wall Ovens)

- 27" : AOES2730, AOCS2740, MEW5527DD, MEW6527DD
- 30" : AOES3030, AOCS3040, MEW5530DD, MEW6530DD, AEW3530DD, AEW4530DD, JJW8130DD, JJW9130DD

 **WARNING**

To avoid risk of electrical shock, personal injury, or death, disconnect power to wall outlet before beginning installation.

Parts, Tools, and Materials

The following parts are supplied with the oven:

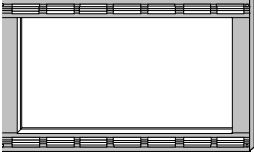

Trim Frame (1)

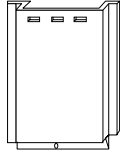

Side Duct (1)

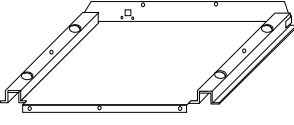

Bottom Duct (1)

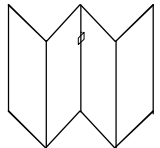

Template (1)

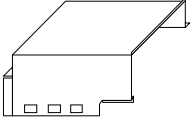

Upper Duct (1)

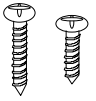

1" Screws (4 required, 2 extra)
1/2" Screws (11 required, 2 extra)

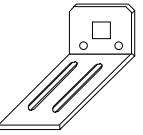

Bottom Bracket (1)



Anti-Tip Bracket (1)

Tools required to perform installation:

- Phillips Screwdriver
- Saw (Electric or Hand)
- Drill with 1/16" and 7/64" drill bits (Electric or Hand)
- Tape Measure
- Pencil
- Framing Square
- Level

Shipping Weight

- Approximate shipping weight is 16 lbs.

Cutout Dimensions

Dimensions	27"	30"
Height	16 3/4"	16 3/4"
Width	25 1/2"	25 1/2"
Depth (min.)	23 3/4"	23 3/4"

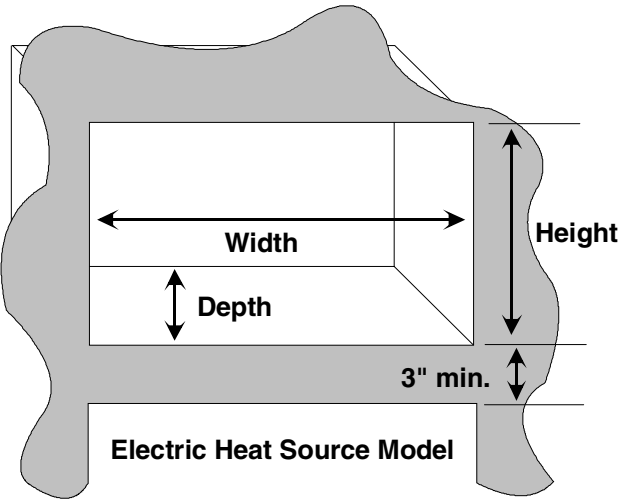

 **WARNING**

To avoid risk of electrical shock, personal injury, or death:

- Before drilling into the wall, note where electrical outlets are and where electrical wire might be concealed behind the wall. **YOU COULD GET AN ELECTRICAL SHOCK** if you contact electrical wire with the drill bit.
- Locate and disconnect the power to any electrical circuits that could be affected by installing this oven. **IF YOU DO NOT DISCONNECT THE POWER, YOU COULD GET AN ELECTRICAL SHOCK.**

 **CAUTION**

To avoid personal injury, wear gloves when handling the metal parts. Parts are sharp and can cause cuts and abrasions.

FTK-127/130 Built-In Trim Kit Installation Instructions

For use with the following microwave oven ACM2160A and UMC5200AA

Electrical rating of this oven:

- 120 VAC @ 60 Hz
- 13 A / 1100 W
- You need a **DEDICATED** 120 VAC, 60 Hz, 20 A, fused electrical supply (located in the cabinet with the microwave as close as possible to the microwave) serving only the microwave.
- Check with a qualified electrician if you are not sure whether the oven is properly grounded or if you do not completely understand the grounding instructions.
- Do not use a fuse in the neutral or grounding circuit.

WARNING

Improper grounding could result in electric shock or other personal injury.

- Save these instructions for the local electrical inspector's use.
- If there is an electrical short circuit, grounding reduces the risk of electrical shock by providing an escape wire for the electric current. This appliance is equipped with a cord having a grounding wire with a grounding plug.
- Place the plug into a properly installed and grounded outlet.
- **Amana does not recommend use of an extension cord.**
- Keep the power cord dry and do not pinch or crush it.
- Do not, under any circumstances, remove the power supply cord grounding prong!
- This appliance **MUST** be grounded!

Properly polarized and grounding outlet.

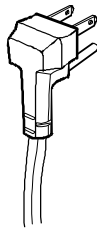

Three-prong (Grounding plug)

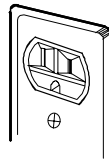

WARNING

If you do not use the microwave oven as instructed, you could be exposed to excessive microwave energy.

Do not expose yourself to excessive microwave energy!

- DO NOT try to operate the microwave oven with the door open.
- DO NOT tamper with or defeat the safety interlocks.
- DO NOT place objects between the microwave oven front face and the door.
- DO NOT allow soil or cleaner residue to build up on the flat surfaces around the microwave oven door.
- DO NOT operate the microwave oven if it is damaged.
- The microwave oven door must close properly to operate safely.
- DO NOT USE THE MICROWAVE OVEN:
- If the door is bent.
- If the hinges or latches are broken or loose.
- If the door seals, sealing surfaces or glass is broken.
- DO NOT ATTEMPT TO ADJUST OR REPAIR THE OVEN YOURSELF!
 - It should be adjusted and repaired by a qualified technician who can check for microwave leakage after repairing the oven.

WARNING

If you do not mount the oven as instructed, you risk personal injury and/or property damage.

CAUTION

Before you begin installing the oven, PLACE A PIECE OF THE CARTON OR OTHER HEAVY MATERIAL (a blanket) over the countertop or cooktop to protect it. **Do not use a plastic cover.** Failure to protect these surfaces could result in property damage.

FTK-127/130 Built-In Trim Kit Installation Instructions

For use with the following microwave oven ACM2160A and UMC5200AA

Installation of Bottom Bracket

1. Disconnect power from microwave oven before proceeding with installation.
2. Remove any loose items from inside the microwave oven.

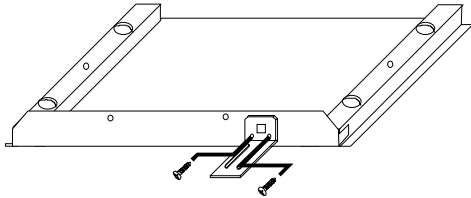

3. Fasten bottom bracket to bottom duct using 1/2" screws (supplied).
4. Turn microwave upside down and place on a protected surface.

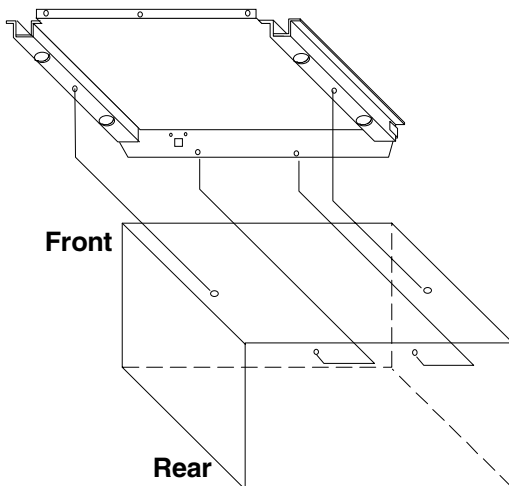

5. Attach bottom duct to bottom of microwave using 1/2" screws (supplied).
6. Turn microwave oven and bracket right side up, placing it on a protected surface.

Installation of Vented Ductwork

1. Remove screw located on left side of microwave below vent louvers.
2. Secure side duct to upper duct, by inserting metal tabs on upper duct into slots on side duct and bending tabs upward as indicated in the following illustration.

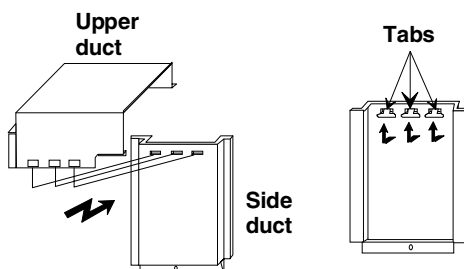

3. Remove any oil or dirt on the surface of the microwave oven where ductwork will be secured.
4. Peel off the protected backing on the double sided tape.
5. Place the existing screw through the ductwork and start securing the screw **DO NOT TIGHTEN**. Slowly push the ductwork towards the microwave keeping proper alignment of the ductwork. Press down firmly to secure the ductwork and tighten the screw securely.

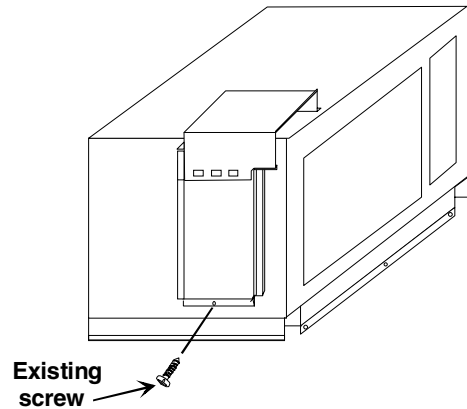

Preparing for Anti-Tip Bracket

1. Fold or cut the edges from the template along the guide lines.
2. Place the template along the front edge of the cutout floor, centering the template from side to side.
3. Mark the hole positions of the anti-tip bracket.
4. Remove the template and drill two holes for anti-tip bracket. Use a drill bit no larger than 7/64" to make holes.

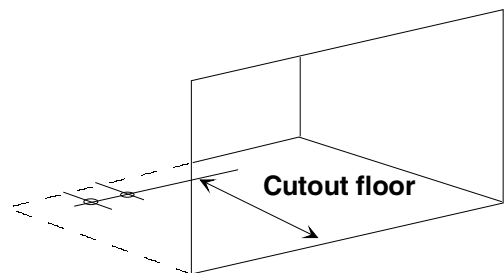

5. Place anti-tip bracket onto the cutout floor and secure using 1/2" screws.

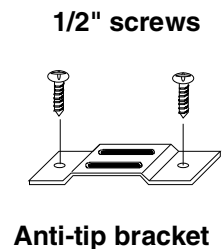

FTK-127/130 Built-In Trim Kit Installation Instructions

For use with the following microwave oven ACM2160A and UMC5200AA

Installing Unit in Cutout

1. Slide microwave oven into cutout verifying alignment of unit is correct.
2. Slide unit out to plug the power cord into the outlet.
3. Slide unit into cutout centering the microwave oven in the cutout opening. Verify anti-tip bracket is engaged.

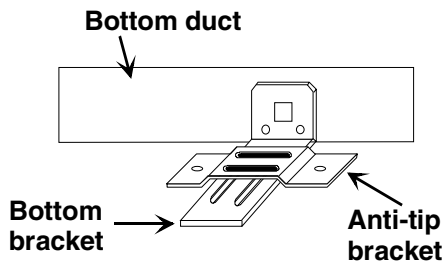

4. Ensure the microwave oven is accurately centered after verifying the anti-tip bracket is engaged.
5. Using a $\frac{7}{64}$ " drill bit drill pilot holes through the positioning flange into wood or metal framing and secure with $\frac{1}{2}$ " screws in the bottom duct.

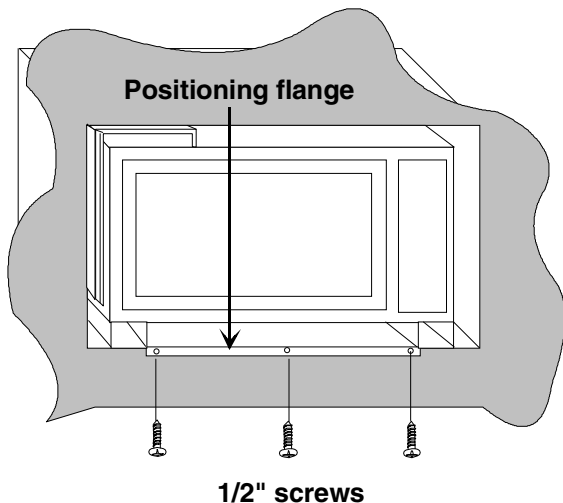

Mounting Trim Frame

1. Position trim frame over the microwave oven.
 2. Verify trim frame is level and the microwave oven is centered within the trim frame.
- NOTE: Center the trim frame equally on all four sides.**
3. Mark center positions screw holes (one in each corner) through the mounting holes of the trim frame.
 4. Remove trim frame and drill previously marked pilot holes in the wood or metal framing using a $\frac{1}{16}$ " drill bit.

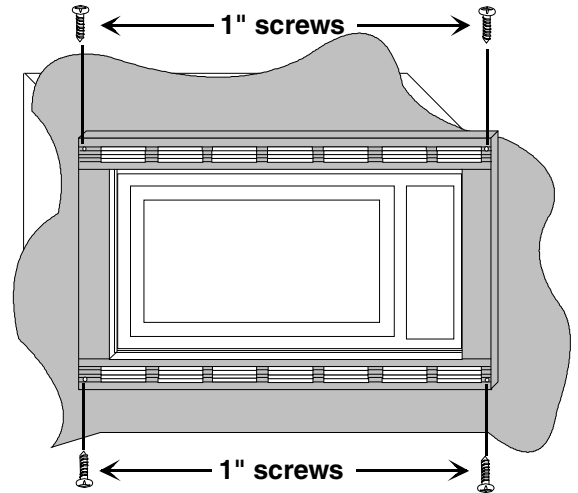

5. Attach trim frame to wood or metal frame work using 1" screws (supplied).

Trim kit is completed

- Replace any loose items that were removed from the inside of the microwave.
- Retain installation instructions for future reference.

Trim Frame Dimensions

Depth of the trim frame is $\frac{7}{8}$ ".

