

This Owner's Manual is provided and hosted by [Appliance Factory Parts](#).



GE JX1830WB Owner's Manual

[Shop genuine replacement parts for GE JX1830WB](#)



[Find Your GE Microwave Parts - Select From 3055 Models](#)

----- Manual continues below -----

Installation Instructions

Built-In Trim Kits

JX1827 and JX1830

Questions? Call GE Answer Center at 800.626.2000 or Visit our Website at: www.GEAppliances.com

BEFORE YOU BEGIN

Read these instructions completely and carefully.

- **IMPORTANT** – Save these instructions for local inspector's use.
- **IMPORTANT** – Observe all governing codes and ordinances.
- **Note to Installer** – Be sure to leave these instructions with the Consumer.
- **Note to Consumer** – Keep these instructions for future reference.
- Unplug the microwave oven before attempting installation of this kit.
- **Skill level** – Installation of this appliance requires basic mechanical and electrical skills.
- **Completion time** – 1-3 hours
- Proper installation is the responsibility of the installer.
- Product failure due to improper installation is not covered under the Warranty.
- This kit is UL listed for installation alone or over any General Electric/Hotpoint/RCA single electric wall oven.

FOR YOUR SAFETY:

WARNING – Before beginning the installation, switch power off at service panel and lock the service disconnecting means to prevent power from being switched on accidentally. When the service disconnecting means cannot be locked, securely fasten a prominent warning device, such as a tag, to the service panel.

TOOLS YOU WILL NEED

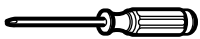

Phillips screwdriver



Pencil



Awl or punch

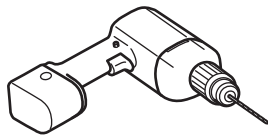



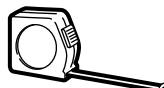



Drill with 7/64" bit or #35

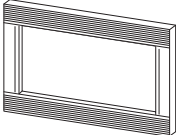
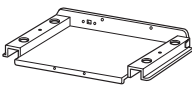

Tape measure

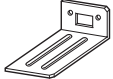
PARTS INCLUDED

PART		QUANTITY
	Trim Frame	1
	Bottom Duct	1
	Side Duct	1
	1" Screws (4 required, 2 extra)	6
	1/2" Screws (11 required, 4 extra)	15
	Anti-Tip Bracket	1
	Bottom Bracket	1
	Upper Duct	1
	Template	1

**READ CAREFULLY.
KEEP THESE INSTRUCTIONS.**

Installation Instructions

1. CUTOUT DIMENSIONS

Models	27"	30"
Height	16 $\frac{3}{4}$ "	16 $\frac{3}{4}$ "
Width	25 $\frac{1}{2}$ "	25 $\frac{1}{2}$ "
Depth (min.)*	19 $\frac{1}{2}$ " or 22"	19 $\frac{1}{2}$ " or 22"

* Min. depth with receptacle outside cabinet 19 $\frac{1}{2}$ "
 Min. depth with receptacle inside cabinet 22"

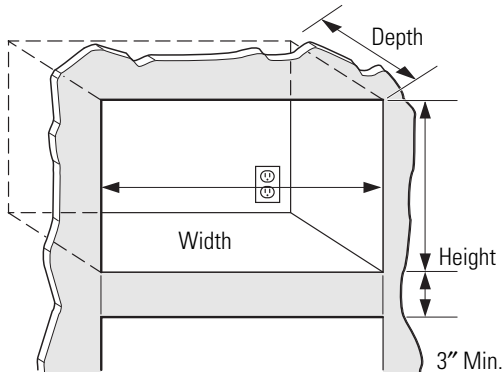

On 27" models, allow 1" at the top, $\frac{1}{16}$ " on the sides and $\frac{1}{8}$ " at the bottom for overlap of the Trim Frame over the edges of the cutout.

On 30" models, allow 1" at the top, $\frac{2}{16}$ " on the sides and $\frac{1}{8}$ " at the bottom for overlap of the Trim Frame over the edges of the cutout.

2. INSTALL BOTTOM BRACKET AND BOTTOM DUCT

- A** Disconnect the microwave oven before proceeding with the installation.
- B** Fasten the bottom bracket to the bottom duct by using two $\frac{1}{2}$ " screws.

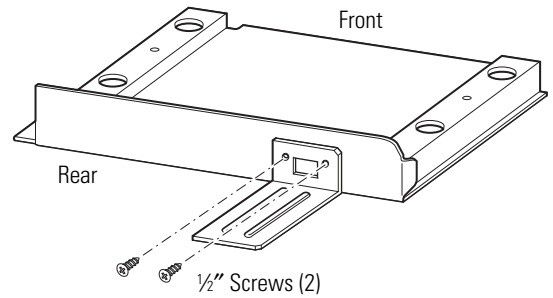

- C** Remove any loose items inside the microwave oven, including the turntable and turntable support. Carefully turn the microwave upside down.
- D** Install bottom duct with four $\frac{1}{2}$ " screws as shown.

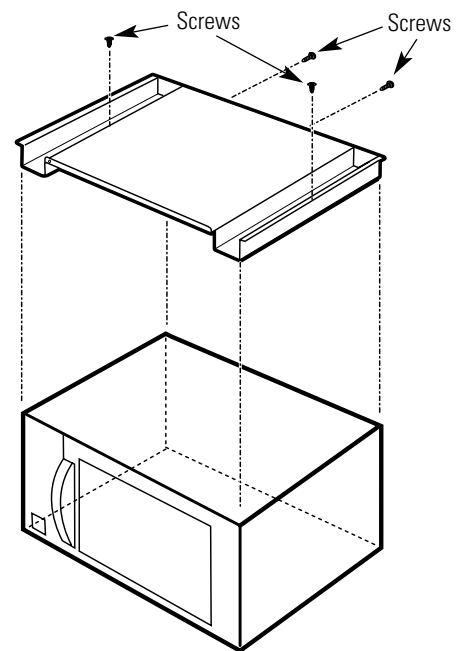

Microwave Oven Upside Down

Installation Instructions

3. INSTALL THE ANTI-TIP BRACKET

- A** Fold or cut the front edge of the template, along the front guide line. Place the template flush along the front edge of the cutout floor, aligning the center line of the template with the center line of the cutout floor. Mark the center positions with an awl or center punch for the anti-tip bracket location as shown.

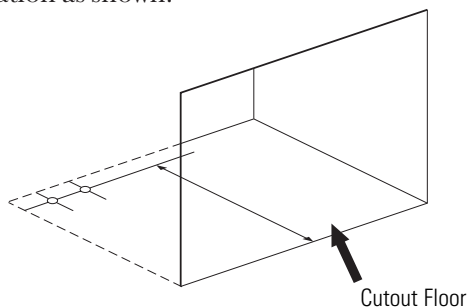

- B** Remove the template and drill two holes for the anti-tip bracket.

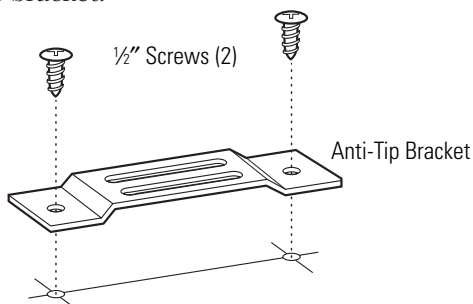

- C** Install the anti-tip bracket onto the cutout floor using two 1/2" screws.

4. INSTALL SIDE DUCT AND UPPER DUCT

- A** Connect the side duct to the upper duct as shown.

1. Insert projecting tabs of the upper duct into the holes of the side duct.
2. Bend the tabs up with caution as shown.

NOTE: Remove any oil or dirt on the surface of the microwave oven before the ducts are attached.

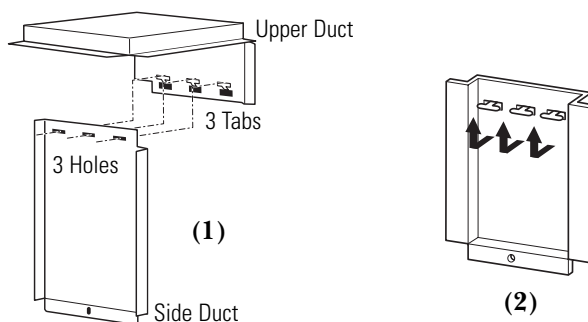

- B** Set the microwave upright, being careful not to bend the front flange. Remove the one existing screw from the left side of the microwave oven.

- C** Peel off the backing of the double sided tape. Carefully position the side duct and upper duct assembly on the microwave cabinet, aligning with the bottom screw hole. Press down firmly on the ducts. Fasten the duct assembly to the left side of the cabinet with the screw removed above.

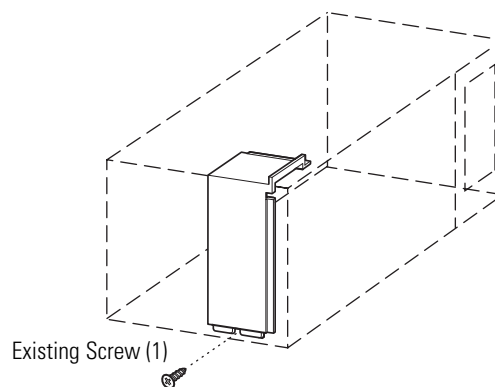

Installation Instructions

5. INSTALL MICROWAVE OVEN INTO CABINET

- A** Slide the microwave oven part way into the cabinet opening.

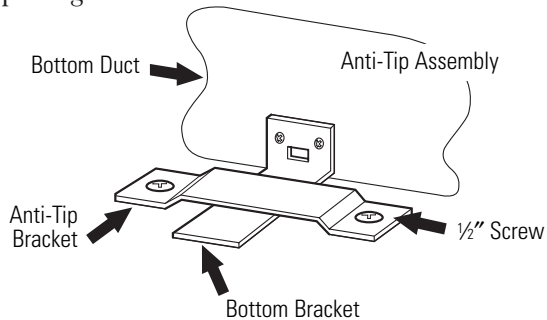

- B** Plug in the microwave oven.
- C** Bottom bracket must be flat to the cutout floor to engage correctly with the anti-tip bracket as shown. Carefully slide the microwave back, making sure the power cord is not mashed or cut.
- D** Center the microwave oven within the cutout opening and slide the microwave oven in place, engaging the anti-tip bracket.
- E** Ensure the microwave oven is **accurately centered**.

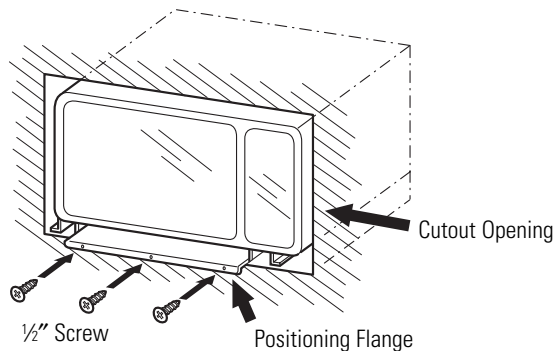

- F** Drill pilot holes through the positioning flange and then install three 1/2" screws at the front of the bottom duct as shown.

6. INSTALLING THE TRIM FRAME

- A** Place the trim frame over the microwave oven.
- B** Make sure the trim frame is level and the microwave oven is centered within the trim frame. Mark four center positions through the four mounting holes of the trim frame.

NOTE: Center the trim frame equally on all four sides.

- C** Remove the trim frame and drill four pilot holes.

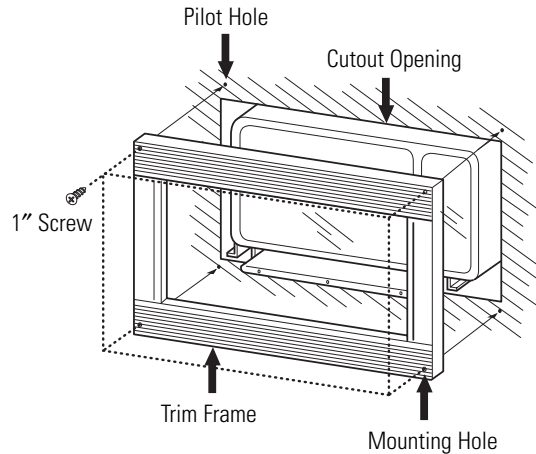

- D** Attach the trim frame by using four screws.

7. REPLACE ANY LOOSE ITEMS

- A** Your trim kit is now fully installed. Replace any loose items that were removed from the inside of the microwave oven.
- B** Keep these installation instructions for future reference.
- C** Replace house fuse or close circuit breaker.

Part No. 245B1790P075

Pub. No. 31-20936-1

3828W5U0053 12-00 JR