

This Owner's Manual is provided and hosted by [Appliance Factory Parts](#).



# LG LYH123ATC52 Owner's Manual

[Shop genuine replacement parts for LG LYH123ATC52](#)



[Find Your LG Air Conditioner Parts - Select From 2328 Models](#)

----- Manual continues below -----



# Installation/Operation Maintenance

---

## Packaged Terminal Air Conditioner



### Models PTED and PTHD

PTED070 PTHD070 (7,000 Btuh)

PTED090 PTHD090 (9,000 Btuh)

PTED120 PTHD120 (12,000 Btuh)

PTED150 PTHD150 (15,000 Btuh)

Cooling/Electric Heat and Heat Pump Models with Unit or Remote Mounted Controls

---

PTAC-SVX01A-EN

# Warnings and Cautions

---

## NOTICE:

Warnings and Cautions appear at appropriate sections throughout this manual.  
Read these carefully.

**▲ WARNING** -Indicates a potentially hazardous situation which, if not avoided, could result in death or serious injury.

**▲ CAUTION** -Indicates a potentially hazardous situation which, if not avoided, may result in minor or moderate injury. It may also be used to alert against unsafe practices.

**CAUTION** -Indicates a situation that may result in equipment or property-damage-only accidents.

# Contents

---

<b>General Information</b>	4
<b>Installation</b>	10
<b>Unit Operation</b>	13
<b>Maintenance</b>	20
<b>Control Board Diagnostics</b>	23
<b>Refrigeration System</b>	24
<b>Component Tests</b>	30
<b>Disassembly Procedures</b>	33
<b>Specifications</b>	40
<b>Performance Charts</b>	44
<b>Schematic Diagrams</b>	44

# General Information

---

## Transportation Damage

All units are securely packed in Trane approved shipping containers. The carton should be checked upon arrival for external damage. If damage is found, a written request for inspection by the carrier's agent should be made immediately.

In the event of damage, the consignee should:

1. Make notation on delivery receipt of any visible damage to shipment or container.
2. Notify carrier promptly and request an inspection.
3. In case of concealed damage, carrier should be notified as soon as possible, preferably within five (5) days.
4. File the claim with the following supporting documents within the six (6) month statute of limitations.
  - a. Original Bill of Lading, certified copy, or indemnity bond.
  - b. Original paid freight bill or indemnity in lieu thereof.
  - c. Original invoice or certified copy thereof, showing trade and other discounts or reductions.
  - d. Copy of the inspection report issued by carrier's representative at the time damage is reported to the carrier.

The carrier is responsible for making prompt inspection of damage and for a thorough investigation of each claim. The distributor or manufacturer will not accept claims from dealers for transportation damage.

## Unit Accessories

This unit is designed for through-the-wall installation in new or existing buildings. To complete the installation of this PTAC, an insulated wall sleeve and an outdoor grille (either the stamped aluminum grille or the architectural grille) are required.

The chassis and the cabinet front are shipped in one carton. Optional items to complete a particular installation can be found in the PTAC product catalog.

## Literature Change History

### **PTEC-M-1 (September 1997)**

Original issue of manual; specifically intended for use by experienced service technicians. Provides operation and maintenance procedures for PTEC and PTHC units of "C" and later designs. Unit specifications, performance data and typical wiring diagram(s) are also included. (RS4200002 397)

### **PTAC-SVN02A-EN (July 2002)**

Product update. New control board features.

### **PTAC-SVX01A-EN (September 2002)**

Combined PTAC-SVN01A-EN and PTAC-SVU01A-EN.

# General Information

---

## Environmental Accountability Policy

Trane urges that all HVAC servicers working on Company equipment or any manufacturer's products, make every effort to eliminate, if possible, or vigorously reduce the emission of CFC, HCFC and HFC refrigerants to the atmosphere resulting from installation, operation, routine maintenance, or major service on this equipment. Always act in a responsible manner to conserve refrigerants for continued usage even when acceptable alternatives are available.

## Recover and Recycle Refrigerants

Refrigerant used in centrifugal water chillers should be recovered and/or recycled for reuse, reprocessed (reclaimed), or properly disposed of, whenever it is removed from the equipment. Never release to atmosphere! Always determine recycle or reclaim requirements of the refrigerant before beginning recovery procedure. Obtain a chemical analysis of the refrigerant if necessary. (Questions about recovered refrigerant and acceptable refrigerant quality standards are addressed in ARI Standard 700).

## Refrigerant Handling and Safety

Consult manufacturer's Material Safety Data Sheets (MSDS) on refrigerants being handled to understand health, safety, storage, handling and disposal requirements. Use approved containment vessels and refer to appropriate safety standards. Comply with all applicable transportation standards when shipping refrigerant containers.

## Service Equipment and Procedures

To minimize refrigerant emissions while recovering the refrigerant, use recycling equipment such as a Company recycle/recovery system or equivalent. Use equipment and methods which will pull the lowest possible system vacuum while recovering and condensing refrigerant. Equipment capable of pulling a vacuum of less than 1,000 microns (1.0 mm) of mercury is recommended. Do not open the unit to atmosphere for service work until the refrigerant charge is fully removed/recovered. When leak-testing with trace refrigerant and nitrogen, use HCFC-22 (R-22) rather than CFC-12 (R-12) or any other fully-halogenated refrigerant. Be aware of any new leak test methods which may eliminate refrigerants as a trace gas. Evacuation prior to charging should be done with a vacuum pump capable of pulling a vacuum of 1,000 microns (1.0 mm) of mercury or less. The unit should stand for 12 hours and the vacuum should not rise above 2,500 microns (2.6 mm) of mercury. A rise above 2,500 microns (2.5 mm) of mercury indicates a leak test is required to locate and repair any leaks. A leak test will be required on any repaired area. Charge refrigerant into the machine only when it is determined that the machine does not leak or contain moisture. Charge refrigerant into the machine by weight. A proper charge is required for efficient machine operation. When charging is complete, purge or drain charging lines into an approved refrigerant container. Seal all used refrigerant containers with approved closure devices to prevent unused refrigerant from escaping to the atmosphere. Take extra care to properly maintain all service equipment directly supporting refrigerant service work

such as gauges, hoses, vacuum pumps, and recycling equipment. When cleaning system components or parts, avoid using CFC-11 (R-11) or CFC-113 (R-113). Use only cleaning-solvents that do not have ozone depletion factors. Properly dispose of used materials. Refrigeration system cleanup methods using filters and driers are preferred. Maintain the purge unit on centrifugal water chillers in proper working condition. An improperly maintained purge unit can cause significant refrigerant emissions to the atmosphere. Consider replacing older operational purge units with the new Company Purifier Purge unit. Excessive purge operation is an indication of possible refrigerant leakage. Check for leaks when excessive purge operation is observed.

## Future Developments

Keep abreast of unit enhancements, conversion refrigerants, compatible parts, and manufacturer's recommendations which will reduce refrigerant emissions and increase equipment operating efficiencies. Follow specific manufacturer's guidelines for conversion of existing equipment. Use only Company approved gaskets, O-rings, oil filters, and other components on centrifugal water chillers or CenTraVacs. In order to assist in reducing power generation requirements, always attempt to improve chiller equipment performance with improved maintenance operations which will help conserve energy resources. Items to be considered include tube cleanliness, proper water flows, correct refrigerant charge, cooling tower maintenance, and proper operation of controls and features such as free cooling, chilled water reset functions, and time of day scheduling.

# General Information

---

## Important Information

Pride and workmanship go into every product to provide our customers with quality products. It is possible, however, that during its lifetime a product may require service. Products should be serviced only by a qualified service technician who is familiar with the safety procedures required in the repair and who is equipped with the proper tools, parts, testing instruments and the appropriate service manual.

## **⚠ WARNING!**

### **Live Electrical Components!**

**During installation, testing, servicing and troubleshooting of this product, it may be necessary to work with live electrical components. Have a qualified licensed electrician or other individual who has properly trained in live electrical components perform these tasks. Failure to follow all electrical safety precautions when exposed to live electrical components could result in death or serious injury.**

# General Information

## Unit Features

The Trane PTAC has many features, some of which are different than those found on conventional PTAC units. The servicer must be familiar with these features in order to properly service the unit.

- **Automatic 3-minute Compressor Lockout** – After the compressor cycles off, it will not restart for three minutes. This feature prevents the compressor from short cycling and extends the overall life.
- **Automatic 2nd Stage Electric Heat (PTHD only)** - If the room temperature falls to 2.5° F below the setpoint temperature or the unit compressor fails, the reverse cycle heat is shut off and the electric heat is turned on.
- **Indoor Room Freeze Protection** - When the unit senses room temperatures of 40°F or below, the unit activates the fan motor and either the electric resistance heater or the hydronic heater to help prevent pipes or fixtures from freezing. This also overrides front desk control of the unit mounted or wall mounted controls.
- **Fuse Holders** – The Trane PTAC is equipped with spaces for fuse holders. All 265V units require fuse holders and fuses. Refer to Figure 1
- **Random Restart Function** – This function allows for the random restart of the Trane PTAC units in a building in the event of a power outage. The restart delay will reduce the initial inrush current from the building to help prevent a second power outage due to too much current draw.  
  
The random restart will occur every 0.5 seconds for 1 minute after the 3 minute compressor off delay.
- **Door Switch/Occupancy Sensor** - The Trane PTAC is capable of accommodating a field installed door switch and occupancy sensor to operate the energy management feature. For additional information, refer to the Unit Operation section.
- **Remote Thermostat Control** - Each unit is built to be operated from any standard 4 or 5 wire remote-mounted thermostat, if desired. The unit has a built-in low voltage power source which can accommodate a large variety of thermostat choices — manual, auto changeover or programmable. A remote thermostat can also be added to any installed unit.
- **Trane Zone Sensor** - Occupants enjoy ultimate comfort with consistent climate control. Attach an optional, inexpensive remote Trane Zone Sensor, to exactly match the functions of the PTAC without disabling any features.
- **Remote Fan Control** – The Trane PTAC has the ability to control a remote fan. (In previous designs, the PTAC Duct Kit was used to supply conditioned air to other rooms.) Whenever the Trane PTAC's indoor fan activates, it will activate the remote fan.
- **Setpoint Limiting** – The setpoint limiting feature can reduce energy costs by controlling the maximum setpoint in heating and the minimum setpoint in cooling.
- **Active Defrost (PTHDs only)** – The Trane PTAC has an active defrosting system that will remove any ice build-up on the outdoor coil that may occur during the heat pump cycle.

**Figure 1 - Fuses**



Install the fuse holder on the bottom of control box



# General Information

## Unit Accessories

Model Number	Description	Model Number	Description
AAGSP	Architectural Aluminum Grilles - Special Color	HSK04	Hydronic Steam Heat Kit - 115V
AAGAL	Architectural Aluminum Grille -Anodized finish	HWIREK	Hard Wire Kit
AAGDB	Architectural Aluminum Grille - Dark Bronze	HWK04	Hydronic Water Heat Kit - 115V
AAGSD	Architectural Aluminum Grille - Soft Dove	HWK02	Hydronic Water Heat Kit - 265V
AUXWIRE	Wire Harness Kit	HWK01	Hydronic Water Heat Kit - 230/208V
SAG01	Stamped Aluminum Grilles - Single Pack	LVLG02	Wall Sleeve Levelling Legs
SAG10	Stamped Aluminum Grilles - Ten Pack	PS0130	Power Switch 230/208V, 30 A
CB0115	Circuit Breaker 230V, 15A	KEYLOK	Control Panel Key Lock
CB0120	Circuit Breaker 230V, 20A	PS0230	Power Switch 265V, 30 A
CB0130	Circuit Breaker 230V, 30A	REK10	Remote Escutcheon Kits - 10 Pack
CB0415	Circuit Breaker 115V, 15A	SUB0120	Subbase 230/208V, 20A
CDP01	Condensate Pump 230/208V	SUB0130	Subbase 230/208V, 30A
CDP02	Condensate Pump 265V	SUB0220	Subbase 265V, 20A
DRAIN	Drain Kit	SUB0230	Subbase 265V, 30A
FILTR10	Ten Pack Filter Kit	TAYSTAT340	1H/1C Digital Prog Tstat (4-wire Pwr Steal)
FUSE0115	Fuse Holder Kit 230/208V, 15A	TAYSTAT371	1H/1C Digital NonProg Tstat (4-wire Pwr Steal)
FUSE0120	Fuse Holder Kit 230/208V, 20A	TAYSTAT540	2H/1C Heat Pump Digital Prog Tstat
FUSE0130	Fuse Holder Kit 230/208V, 30A	TAYSTAT570	2H/1C Heat Pump Digital NonProg Tstat
HSK01	Hydronic Steam Heat Kit - 230/208V	WS130	Standard Wall Sleeve
HSK02	Hydronic Steam Heat Kit - 265V	WS180	Extended 18" Wall Sleeve
		WS240	Extended 24" Wall Sleeve
		PFC01	Plastic Front Cover
		ZONSENS	Zone Sensor

# Model Number Description

For service purposes, Model PTED, PTHD Package Terminal Air Conditioner/Heat Pumps are assigned a multiple-character alphanumeric model number that precisely identifies each unit. An explanation of the identification code that appears on the unit nameplate is shown below.

Use of the service model number will enable the owner/operator, installing contractors, and service technicians to define the operation, components and options for any specific unit. Refer to the model number printed on the panel nameplate when ordering replacement parts or requesting service.

**PT E D 090 1 G \* A**  
**12 3 4 567 8 9 10 11**

### ***Digits 1,2 — Packaged Terminal Air Conditioner***

### ***Digit 3 — Product Type***

E = Air Conditioner  
H = Heat Pump

### ***Digit 4 — Development Sequence***

D = Fourth Development

### ***Digits 5,6,7 — Unit Cooling Capacity***

070 = 7,000 Btu  
090 = 9,000 Btu  
120 = 12,000 Btu  
150 = 15,000 Btu

### ***Digit 8 — Main Power Supply***

1 = 208-230V/60Hz/1phase  
2 = 265V/60Hz/1phase  
4 = 115V/60Hz/1phase\*

### ***Digit 9 — Electric Heating Capacity\*\****

W = Hydronic\*\*\*  
D = 2.0 kW  
G = 3.5 kW - 208-230V  
G = 3.7 kW - 265V  
J = 5 kW\*\*\*\*

### ***Digit 10 — Design Sequence***

### ***Digit 11— Miscellaneous***

A = Standard  
C = Corrosion Resistant  
D = Condensate Pump

\*Hydronic unit only. Sizes 07, 09, and 12 only.

\*\*All heat pump units must have electric coils.

\*\*\*Hydronic units ship with no electric heat and no plastic front cover. The hydronic kit, which must be ordered separately, includes a metal front cover.

\*\*\*\*Sizes 09, 12 and 15 only.

# Installation

## Attention Installation Personnel

As a professional installer you have an obligation to know the product better than the customer. This includes all safety precautions and related items.

Prior to actual installation, thoroughly familiarize yourself with this Instruction Manual. Pay special attention to all safety warnings. Often during installation or repair it is possible to place yourself in a position which is more hazardous than when the unit is in operation.

Remember, it is your responsibility to install the product safely and to know it well enough to be able to instruct a customer in its safe use.

Safety is a matter of common sense—a matter of thinking before acting. Most dealers have a list of specific good safety practices—follow them.

## About This Manual

**Important Note:** To prevent machine damage, contact a qualified service organization to perform the check-out procedure described at the end of this manual!

## Important Note to the Owner

This equipment is to be serviced by professionally trained personnel only. If this equipment is improperly installed, adjusted or altered by an unqualified person, a safety hazard may result.

## Important Note to the Servicer

Read this manual and familiarize yourself with the specific items which must be adhered to before attempting to service this unit. The precautions listed in this manual should not supersede existing practices but should be considered as supplemental information.

## General

To ensure that the unit operates safely and efficiently, it must be installed, operated and maintained according to these installation and operating instructions and all local codes and ordinances or, in their absence, with the National Electric Code. The proper installation of this unit is described in the following sections. Following the steps in the order presented should ensure proper installation.

## Rear Closure Panel Removal

Before the chassis can be installed in the wall sleeve, the sleeve stiffener and the rear closure panel shown in Figure 2 and Figure 3 must be removed.

Figure 2 - Sleeve

### Sleeve Stiffener

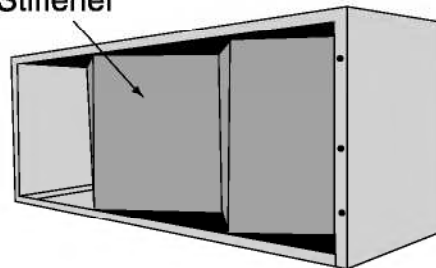

1. Remove the zigzag folded cardboard sleeve stiffener.

Figure 3 - Sleeve

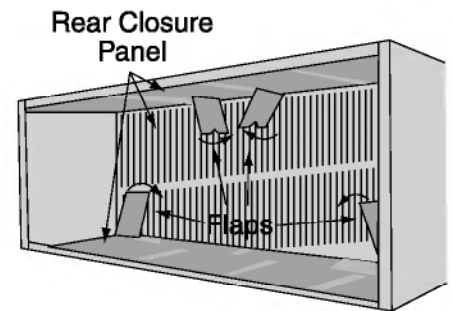

2. Remove the rear closure panel by folding the four flaps as indicated in Figure 3.

Figure 4 - Sleeve

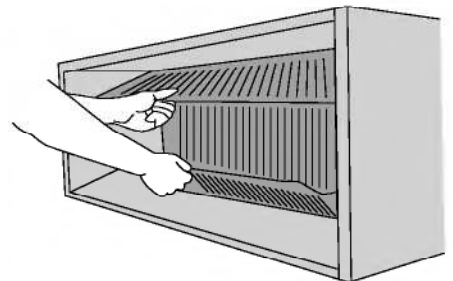

3. Grasping the top and bottom flanges of the rear closure panel as shown in Figure 4, the entire panel is pulled out diagonally from one side.

# Installation

## Drain Kit

During normal operation, condensate water may drain out of the rear of the wall sleeve. If this water is objectionable, a drain kit should be installed. The drain kit has provisions for draining the water from either the right or left side of the sleeve externally, or from the bottom of the sleeve internally. The drain kit must be installed before the outdoor grille is installed. Refer to the Installation Instructions supplied with the drain kit for a complete description of the installation procedure.

## Sleeve Installation

In order for condensate water to drain properly inside the unit, the sleeve must be installed properly:

- Level from right to left.
- A slight downward pitch from the indoor side to the outdoor side as shown in Figure 5.
- Caulk around the exterior and interior joint between the wall sleeve and the wall.

Refer to the Installation Instructions supplied with the PTAC wall sleeve for a complete description of the installation procedure.

## Outdoor Grille

An outdoor grille must be installed to direct air flow for proper unit operation and also to protect the outdoor coil. Before installing the chassis, the grille must be installed. Refer to the Installation Instructions supplied with the outdoor grill kit for a complete description of the installation procedure.

This model requires either a Stamped Grille or an Architectural Grille. When replacing an old chassis with an existing grille, please check with your sales representative to determine if the new chassis should be used with the old outdoor grille. An improper outdoor grille can decrease cooling or heating capacity, increase energy usage or shorten compressor life.

## Front Removal

1. Grasp the cabinet front as shown in Figure 6.
2. Pull the bottom of the cabinet front away from the chassis until the retaining clips disengage. (Figure 7)
3. Lift the cabinet front off the chassis. Reverse this procedure to reinstall the cabinet front.

Figure 5 - Sleeve Pitch

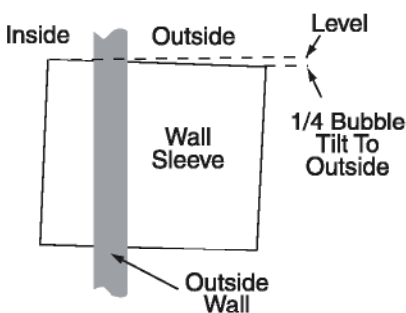

Figure 6 - Front Removal

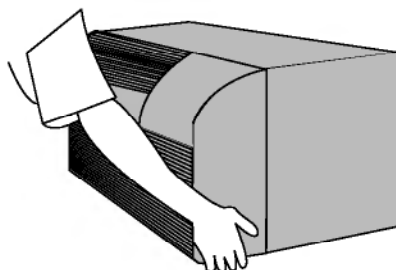
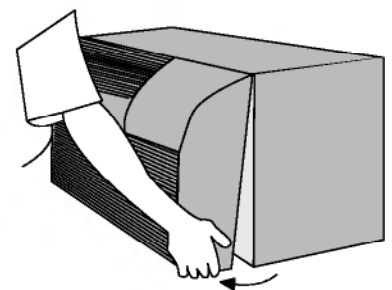

Figure 7 - Front Removal



# Installation

## Chassis Installation

1. Remove the cabinet front from the chassis as described in Front Removal.
2. Insert the chassis into the wall sleeve. (Figure 8)
3. Slide the chassis into the wall sleeve until the chassis flanges contact the front edge of the wall sleeve. (Figure 9)
4. Secure the chassis to the wall sleeve using three screws on each side of the chassis to ensure a proper seal between the chassis and the wall sleeve (Figure 9). The screws are supplied in a plastic bag which is attached to the power cord.

Figure 8 - Chassis Install

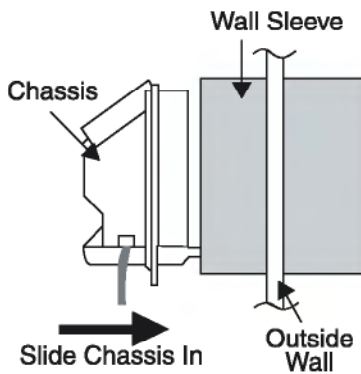

## Notes:

1. The unit is equipped with a rubber grommet mounted compressor. These grommets are factory set and require no adjustment.
2. Check the indoor and outdoor grilles for obstructions to air flow. The unit must be located where curtains, furniture, trees, or other objects do not block the air flow to and from the unit. If air is obstructed and/or deflected back into the unit, the air conditioner's compressor may cycle on and off rapidly. This could damage the compressor.

Figure 9 - Chassis Install

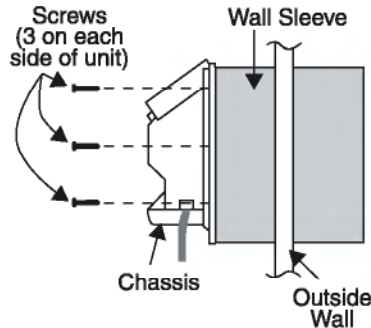

## Wiring

### ⚠ WARNING

#### Live Electrical Components!

During installation, testing, servicing and troubleshooting of this product, it may be necessary to work with live electrical components. Have a qualified licensed electrician or other individual who has been properly trained in handling live electrical components perform these tasks. Failure to follow all electrical safety precautions when exposed to live electrical components could result in death or serious injury.

*Important Note: To avoid the risk of electrical shock, personal injury or property damage, do not use an extension cord with this unit.*

### CAUTION

#### Use Copper Conductors Only!

Unit terminals are not designed to accept other types of conductors. Failure to use copper conductors may result in equipment damage.

*Important Note: To avoid the risk of personal injury, wiring to the unit must be properly polarized and grounded.*

Cord connection to a wall socket is not permitted for 265-volt units. All 265-volt units must be hard wired using the hard wire kit or make use of the plug-in receptacle in the standard subbase.

# Unit Operation

## Operating Instructions

### Users Controls

Two rotary knobs controlling temperature and operational mode are located behind the control door located to the top-right of the cabinet front.



### Temperature Control Setting

Turning the temperature control clockwise will provide a warmer room temperature; turning it counterclockwise will provide a cooler room temperature. Adjusting the temperature control to the mid setting (vertical) will set the room temperature at approximately 70° F.

## WARNING!

### ⚠ Hazardous Voltage!

Disconnect all electric power, including remote disconnects before servicing. Follow proper lockout/tagout procedures to ensure the power can not be inadvertently energized. Failure to disconnect power before servicing could result in death or serious injury.

### Mode Switch

The table below describes the unit function corresponding to the various mode switch settings.

Mode Switch Settings	
Switch Position	Unit Function
HIGH HEAT	Heat pump operation/Electric Heat will operate along with the high fan setting.
LOW HEAT	Heat pump operation/Electric Heat will operate along with the low fan setting.
HIGH FAN	The unit will operate in the high fan mode only.
LOW FAN	The unit will operate in the low fan mode only.
OFF	Fan based on settings of dip switches #1 and #2; No Heat, No Cool.
LOW COOL	The unit will operate in the cooling mode along with the low fan operation.
HIGH COOL	The unit will operate in the cooling mode along with the high fan operation.

### Additional Control Inputs

The control inputs shown below provide additional unit control and features. To access these control inputs and all DIP (Dual In-Line Package) Switches, the cabinet front must be removed. Refer to Front Removal in the Installation section. Furthermore, to access all the control board user inputs as well as the unit

DIP Switches, the terminal strip cover must be removed. After removing the cabinet front, one screw must be removed from the terminal strip cover and then it can be removed. The unit's DIP switches and low voltage terminals will then be visible. Below is an illustration of the low-voltage terminals.

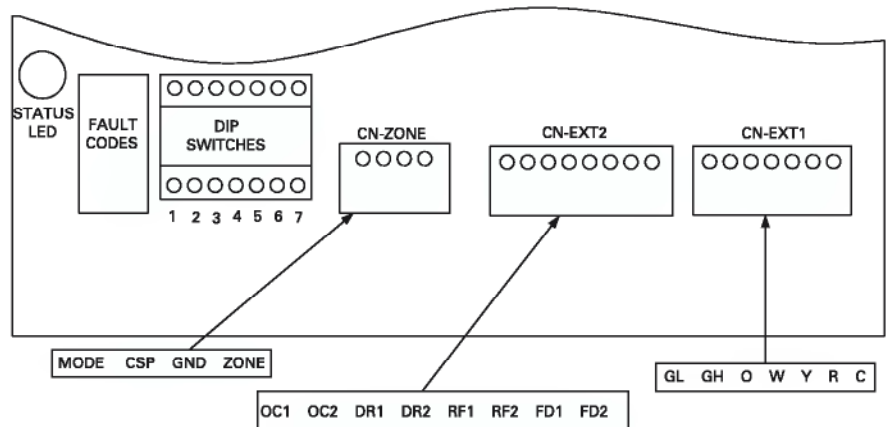

## Unit Operation

### ▲ WARNING!

#### Hazardous Voltage!

Disconnect all electric power, including remote disconnects before servicing. Follow proper lockout/tagout procedures to ensure the power can not be inadvertently energized. Failure to disconnect power before servicing could result in death or serious injury.

#### Unit DIP Switches

The Trane PTAC has a series of seven DIP Switches that provide a wide array of unit features. The table below summarizes the function of each switch. Following the table is a short explanation of what each switch does. Note that the position of a DIP Switch that is in the ON position is up.

Switch Number	Switch Description	Function Description	Default Settings Factory
1	Fan Cycle Switch 1	Sets the operational mode of the fan	OFF
2	Fan Cycle Switch 2	Sets the operational mode of the fan	OFF
3	Setpoint Limit Switch 1	Setpoint limiting mode.	OFF
4	Setpoint Limit Switch 2	Setpoint limiting mode.	OFF
5	Control Location Switch 1	Determines the location of the mode, setpoint and temperature inputs	OFF
6	Control Location Switch 2	Determines the location of the mode, setpoint and temperature inputs	OFF
7	Unit Type	Determines the type of unit (PTAC or PTHP)	ON - PTHD OFF - PTED

# Unit Operation

Figure 10 – Fan Cycle Dip Switches

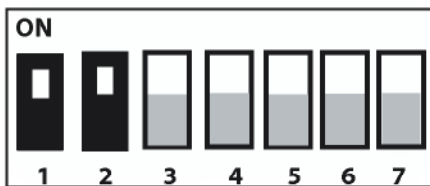

### Fan Cycle Switch

The fan cycle switches set the operational mode of the indoor fan.

Refer to the table below for switch settings and unit operation.

SW1	SW2	Indoor Fan Cycle Mode
OFF*	OFF*	Indoor Fan will Cycle ON/OFF. The fan will not run when the unit mode switch is in the "OFF" position or the Front Desk Control is enabled.
OFF	ON	Indoor Fan will run continuously based on the selected fan speed. The fan will not run when the unit mode switch is in the "OFF" position or the Front Desk Control is enabled
ON	OFF	Indoor Fan will run continuously based on the selected fan speed. The fan will run in high speed when the unit mode switch is in the "OFF" position. The fan will not run when the Front Desk Control is enabled
ON	ON	Indoor Fan will run continuously based on the selected fan speed. The fan will run in high speed when the unit mode switch is in the "OFF" position or the Front Desk Control is enabled

Figure 11 – Electronic Temperature Limiter Dip Switches



### Setpoint Limiting Switches

Setpoint limiting limits the lowest temperature that can be obtained in

cooling and the highest temperature that can be obtained on heating. Refer to the table below for settings.

		Setpoint Limiting Mode (°F)			
		Cooling		Heating	
SW3	SW4	Minimum	Maximum	Minimum	Maximum
OFF*	OFF*	50°	90°	50°	90°
OFF	ON	55°	90°	50°	85°
ON	OFF	60°	90°	50°	80°
ON	ON	65°	90°	50°	75°

Figure 12 – Control Location Dip Switches

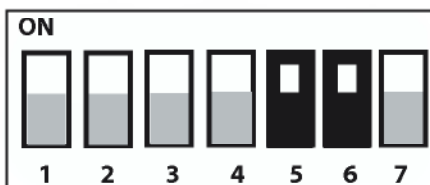

### Control Location Switches

The control location switches are used to indicate where the unit will read the mode, setpoint, and temperature inputs. Review the switch settings below and configure appropriately.

Below is a table detailing the settings for switches 5 and 6. For more information on operating the PTAC with a remote thermostat or Zone Sensor, refer to the Remote Thermostat/Zone Sensor Operation subsection in this section.

SW5	SW6	Mode	Setpoint	Temperature
OFF*	OFF*	Unit	Unit	Unit
OFF	ON	Zone Sensor	Zone Sensor	Zone Sensor
ON	OFF	Zone Sensor	Zone Sensor	Unit
ON	ON	T-stat	T-stat	T-stat

Figure 13 – Unit Type Dip Switches

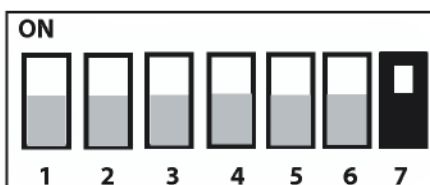

### Unit Type Switch

The Unit Type switch, dip switch 7, tells the PTAC control what type of unit it is controlling. It is very important that this switch is in the correct position.

The Unit type is determined by the position of this switch as follows:  
 "OFF" = PTED  
 "ON" = PTHD  
 These switches will be set in the factory to properly indicate what type of unit is in operation.

\* Indicates default settings.

# Unit Operation

## Control Board User Inputs

The following diagram shows the low-voltage control inputs available on the Trane PTAC. Front Desk Control, Zone Sensing, Remote Thermostat, and Door Switch/Occupancy Sensing, as well as additional features are all controlled from this location. A wiring harness kit is required for this installation.

### Remote Thermostat Operation

The GL, GH, O, W, Y, R, and C terminals provide control inputs for a remote wall mounted thermostat.

To operate this unit with a remote thermostat, DIP Switches 5 and 6 must be in the ON position. When in the remote thermostat mode, the unit will only respond to the thermostat inputs (terminal strip positions GL, GH, W, Y and O shown). The unit mode switch and on-board thermostat used for standard operation will be automatically overridden. The Room temperature will be sensed from the remote thermostat.

### Control Board User Inputs

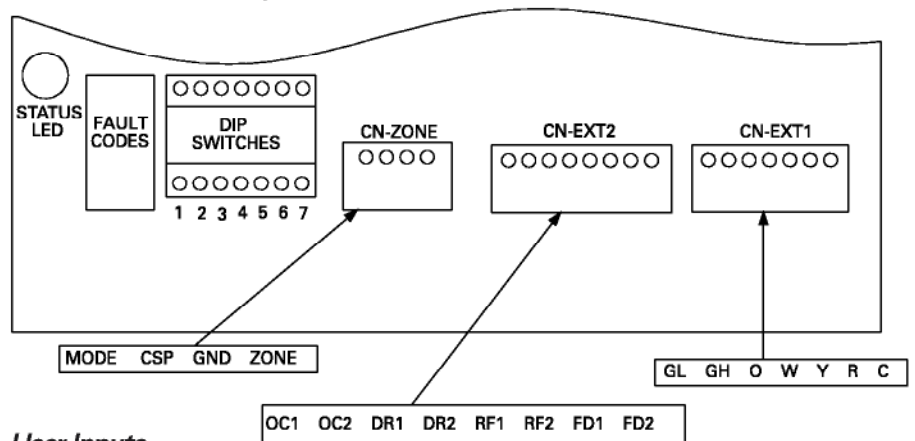

### User Inputs

Input	Function
<b>CN-ZONE</b>	
Mode	Heating or Cooling Mode
CSP	Consumer Setpoint
GND	Electrical ground
Zone	Zone Temperature
<b>CN-EXT2</b>	
OC1	Occupancy Sensor Input1
OC2	Occupancy Sensor Input2
DR1	Door Switch Input1
DR2	Door Switch Input2
RF1	Remote Fan Input1
RF2	Remote Fan Input2
FD1	Front Desk Input1
FD2	Front Desk Input2
<b>CN-EXT1</b>	
GL	Remote T-Stat - Fan Low
GH	Remote T-Stat - Fan High
O	Remote T-Stat - Reversing Valve
W	Remote T-Stat - Heating Input
Y	Remote T-Stat - Compressor
<b>Input</b>	
R	Remote T-Stat - 24 VAC
C	Remote T-Stat - Common

### Notes:

1. In the remote mode, the 3-minute compressor time delay, the random restart feature and the freeze protection feature are all active. The following functions are disabled at the control:
  - 1 Unit Mode Switch
  - 2 Unit Temperature Control
  - 3 Fan Cycle Switch
  - 4 Electronic Setpoint limiting
  - 5 Energy Management Feature (Occupancy sensor and door switch)

# Unit Operation

## ⚠ WARNING!

### Hazardous Voltage!

Disconnect all electric power, including remote disconnects before servicing. Follow proper lockout/tagout procedures to ensure the power can not be inadvertently energized. Failure to disconnect power before servicing could result in death or serious injury.

### Remote Thermostat Location

This unit is designed to be operated with any 4 or 5 wire remote wall mounted Thermostats. For further information on thermostats approved for use with this unit, contact your sales representative. For best performance results, the thermostat should be located approximately five feet above the floor on a vibration free inside wall, in an area with good air circulation. Do not install the thermostat where it may be affected by the following: dead spots behind doors, in corners or under cabinets, hot or cold drafts from air ducts, radiant heat from the sun, appliances, fireplaces, concealed pipes, chimneys, unheated (uncooled) areas behind the thermostat, such as outside walls. Consult the instruction sheet packaged with the thermostat for further details on mounting and operation.

**Table 1 – Remote Control Thermostat Input Voltages**

PTED	Mode	Voltages per Terminal - PTHD					Voltages per Terminal -				
		GH	GL	W	Y	O	GH	GL	W	Y	O
	High Heat Heat Pump Heating	24	0	0	24	0	X	X	X	X	X
	Low Heat Heat Pump Heating	0	24	0	24	0	X	X	X	X	X
	High Heat Electric Heating	24	0	24	24	0	24	0	24	0	X
	Low Heat Electric Heating	0	24	24	24	0	0	24	24	0	X
	High Emergency Heat Electric Heating	24	0	24	0	0	X	X	X	X	X
	Low Emergency Heat Electric Heating	0	24	24	0	0	X	X	X	X	X
	High Cooling	24	0	0	24	24	24	0	0	24	X
	Low Cooling	0	24	0	24	24	0	24	0	24	X
	High Fan	24	0	0	0	0	24	0	0	0	X
	Low Fan	0	24	0	0	0	0	24	0	0	X
	OFF	0	0	0	0	0	0	0	0	0	X

## ⚠ WARNING!

### Hazardous Voltage!

Disconnect all electric power, including remote disconnects before servicing. Follow proper lockout/tagout procedures to ensure the power can not be inadvertently energized. Failure to disconnect power before servicing could result in death or serious injury.

### Thermostat HEAT/OFF/COOL Switch

OFF - cooling and heating functions are defeated.  
 HEAT - the selected room temperature is maintained by cycling either in the heat pump mode or electric heat. A PTHD unit is switched from the heat pump mode to electric heat when the outdoor air temperature is below 20° F (approximately), or when the heat pump cannot keep up with the heating load and a two-stage thermostat is used.  
 COOL - the selected room temperature is maintained by cycling the air conditioner.

### Thermostat Fan Switch

AUTO - the fan cycles with the compressor or electric heat.  
 ON - The fan runs continuously regardless of any other settings.

The following figures show wiring schematics for heat pump and straight cool units with electric heat, respectively. Remote hydronic heat installations should be wired similar as for a straight cooling unit.

(continued on next page)

**Wiring Schematic for Remote Heat Pump**

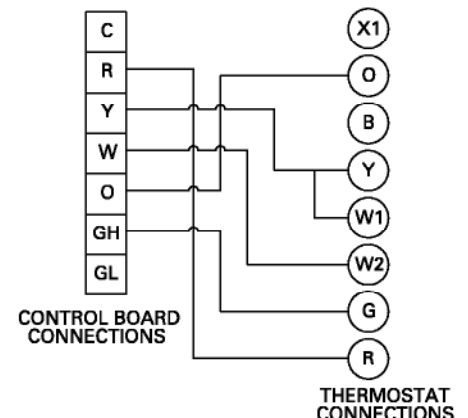

**Wiring Schematic for Straight Cool Unit.**

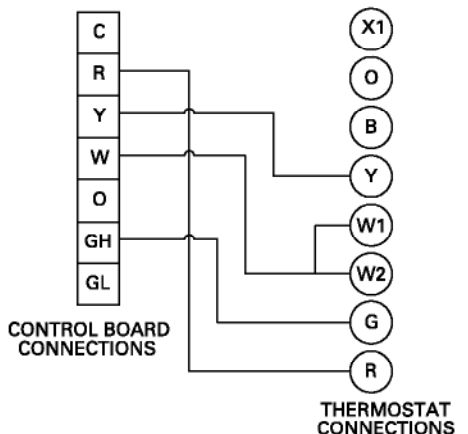

# Unit Operation

(thermostat section cont.)

**NOTE:** If the thermostat being used to control the Trane PTAC has connections available for GL and GH (Fan High and Fan Low) the wiring may be done in that manner. If not, only one or the other may be used.

**Note:**

1. For heat pump operation, a room thermostat with an "O" (heating changeover) terminal is required. This will mean that some "auto changeover" thermostats cannot be used, as many of them either do not have an "O" terminal, or else energize the "O" terminal continuously when in the "auto" position.

**Trane Zone Sensor**

Control functions can remain at the unit or at the zone sensor. The Trane Zone Sensor feature is a unique accessory in that it is capable of providing accurate sensing of room temperature from a central location, separate from the unit. Depending on the DIP Switch settings, the Trane Zone Sensor can sense room temperatures from a central location and at the same time, control the unit's mode from that central location. Unlike using a remote thermostat, setpoint limiting, the fan cycle switches, the energy management features and front desk control will all remain active. Refer to the Schematic Diagrams section for wiring information.

**NOTE:** Freeze protection temperatures will be sensed by the Trane Zone Sensor and not at the PTAC unit. The zone sensor is connected to the unit using a four-pin low voltage connector as shown in the Schematic Diagrams section. Also, Refer to the Installation Instructions supplied with the Zone Sensor kit for further information.

**Trane Zone Sensor**



**Table 2- Maximum Wire Length for Front Desk Switch and Remote Control Connections**

External Interface	Wire Specification	
	Size	Max. Length
Thermostat	#20	60 ft (18m)
	#18	66 ft (20m)
FDC	#22	600 ft (183m)
	#20	900 ft (274m)
	#18	1500 ft (457m)
Remote FAN	#20	60 ft (18m)
	#18	66 ft (20m)
Door Switch	#20	60 ft (18m)
	#18	66 ft (20m)
PIR Sensor	#20	60 ft (18m)
	#18	66 ft (20m)

# Unit Operation

### Front Desk Control (FD1, FD2 Inputs)

The FD1 and FD2 terminals provide control inputs for a front desk switch. Shorting across these two terminals will disable unit operation. The only control function which will remain active when these terminals are shorted is freeze protection. Depending on the Fan Cycle DIP Switch settings, the indoor fan can operate when the control is in Front Desk mode. Any switch which will produce a short circuit across these two terminals, and when closed have less than 200 ohms of contact resistance can be used as a front desk switch. Refer to the Schematic Diagrams section for instructions on Front Desk Control wiring.

**Important Note: Do not apply 24VAC across The FD1 and FD2 terminals. Applying 24VAC to these terminals will result in failure of the control board. Shorting these terminals to any other terminals may also result in control board failure.**

### Door Switch/Occupancy Sensor (DR1, DR2, OC1, OC2 Inputs)

When the door switch changes state (the door opens or closes), the unit control starts a 35 minute timer. If at the end of the 35 minutes, the occupancy sensor does not detect room movement, the unit is in "Occupied-Standby" Mode. If at any time during the 35 minutes the occupancy sensor detects motion, the unit is in "Occupied" Mode. Once the room is in an "Occupied" Mode, the control will ignore the occupancy sensor until a state change on the door switch input occurs. For additional energy savings, when the unit is in "Occupied-Standby" mode, the setpoint temperature is adjusted 4°F down in the heating mode or 4°F up in the cooling mode. Refer to the Schematic Diagrams section for

wiring information. Contact Trane Sales for more information on Occupancy Sensors and Door Switches.

### Remote Fan Operation

The Trane PTAC has the ability to operate a remote fan in conjunction with the unit's indoor fan. The remote fan will provide conditioned air to additional rooms or to areas that are not well ventilated. The remote fan will operate any time the indoor fan on the PTAC unit is operating. The remote fan will require a 24 VAC relay that will connect to the RF1 and RF2 terminals on the control board user inputs. This relay can be purchased from any Trane Parts Center. The actual remote fan is not supplied by Trane. Refer to the Schematic Diagrams section for wiring details.

The vent control allows fresh air to be drawn into the conditioned area. This fresh air can provide ventilation when the indoor fan is operating, but it will increase the heating or cooling load and operating costs. To obtain access to the vent control, remove the cabinet front and locate the vent control lever on the left side of the chassis. Push the vent control lever up to open the vent or down to close the vent. The vent door will be closed and secured by a screw when shipped from the factory. On units with hydronic heat, the vent door must be left closed when the outdoor temperature might fall below freezing. This is in order to avoid the risk of freezing the steam or water coil during prolonged shut down periods.

### Air Discharge Grille

The discharge grille can be adjusted to expel air at either a 15° or 40° (40° default) angle. Refer to the diagram below to alter the airflow angle.

Vent Lever

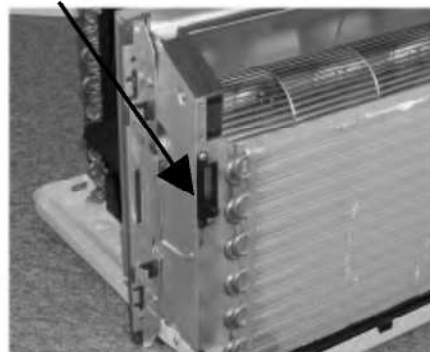

### Vent Control

**⚠ WARNING!**  
**Hazardous Voltage!**

**Disconnect all electric power, including remote disconnects before servicing. Follow proper lockout/tagout procedures to ensure the power can not be inadvertently energized. Failure to disconnect power before servicing could result in death or serious injury.**

Discharge Grille Orientation Options

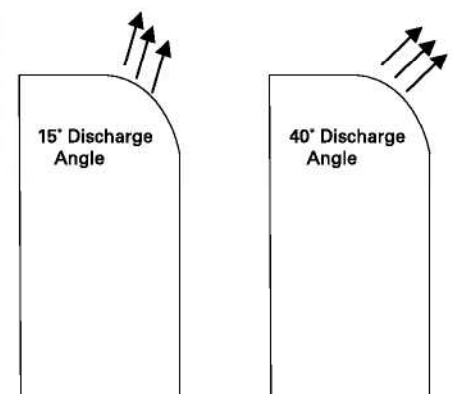

## Unit Operation

---

Use the following procedure to change the angle of the discharge air flow:

1. Remove the front cabinet
2. Position the front cabinet so that the backside is accessible
3. Remove the four screws which secure the discharge air grille to the cabinet front with a Phillips-Head screwdriver.
4. Rotate the grille 180° end-for-end.
5. Reinstall the screws securing the discharge air grille to the cabinet front. Reinstall the cabinet front on the unit.

### *Discharge Air Grille*

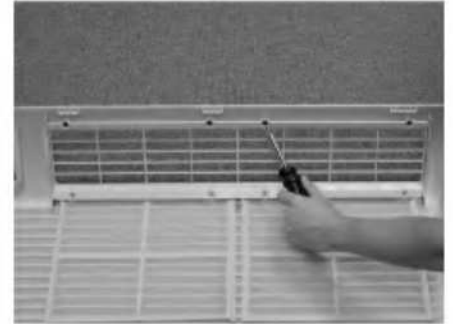

# Maintenance

---

## Chassis

The chassis must be cleaned every four months or more often as the atmospheric conditions require. Use water and detergent to clean the basepan, center partition and coils. The use of harsh cleaning materials may cause a deterioration of the coil fins or endplates. Do not use a high pressure cleaner as it could cause severe damage to the PTAC fins and coils. A hose is okay to use to clean the coils, but make sure to cover the control with a blanket or plastic bag to prevent it from getting wet. Corrosion Resistant units operating in harsh atmospheric conditions must be removed from the sleeve and cleaned every 3 months in the same manner as above.

## Compressor / Fan Motor

The compressor and fan motor are hermetically sealed, permanently lubricated and require no additional oiling.

## Cabinet Front

The cabinet front and discharge air grille can be cleaned with a mild soap or detergent. Under no circumstances should hydrocarbon based cleaners (e.g. acetone, benzene, naphtha gasoline, etc.) be used to clean the front or air grilles. Use care when cleaning the control area. Do not use an excessively wet cleaning cloth.

## Corrosion Resistant Models

Corrosion resistant models subjected to harsh seacoast environments must be removed from the wall sleeve and completely flushed with clean water at least four times a year. The basepan, center partition, condenser end plates, and the condenser itself should be sprayed with clean, fresh water. Leaving the unit in the sleeve and simply spraying the outdoor grille is not sufficient.

## Intake Air Filter

The intake air filter and vent door filter are both constructed of durable polypropylene. Before cleaning the intake filter, turn the unit off by setting the mode switch to the OFF position. Filter should be cleaned as required.

To remove the air filters, grasp the top of the filter and lift out of the front cabinet (Figure 14). Reverse the procedure to reinstall the filters.

*Figure 14 - Filter Removal*



# Maintenance

---

## Vent Filter

Before cleaning the vent filter, disconnect power to the unit by unplugging the power cord at the wall outlet or subbase, or disconnect power at the fuse box or circuit breaker. If unit is operated with vent door closed, the vent filter does not need to be cleaned.

1. Remove the cabinet front as described in Front Removal.
2. Remove the six screws securing the chassis to the wall sleeve with a Phillips-Head screwdriver.
3. Slide the chassis out of the wall sleeve far enough so that the vent filter is accessible as shown in Figure 15.
4. Remove the vent filter by unscrewing the two screws at the top of the filter and gently pulling the filter away from the partition panel. Refer to Figure 16.
5. Clean and replace the filter by reattaching the hook to the bottom of the vent door and replacing the two screws, slide the chassis back into the wall sleeve, secure it in place with six screws and reinstall the front cabinet.

## Scheduled Maintenance

To achieve top performance and high efficiency, a cleaning/ inspection schedule must be established for this unit. Maintaining this schedule can be accomplished by either a local maintenance staff or an authorized servicer and must follow the instructions described in this manual.

- If the unit is operated in a dusty climate, dust may collect in the basepan and clog the condenser coil. It is advisable to remove the unit from the sleeve and thoroughly clean the basepan and condenser coil on a periodic basis.
- If the unit is installed ocean side or in a corrosive atmosphere, its life may be greatly reduced by the corrosive environment. Under these conditions the unit should be removed from the sleeve and completely cleaned at least four times per year. At that time any scratches or blisters on the painted surfaces should be sanded and repainted.

## Obtaining Service

In the unlikely event this unit requires repair or servicing beyond what is covered in this manual, contact your local sales representative or agency.

To obtain a listing of sales representatives or agencies in your area, please call 800-755-6338.

*Figure 15 – Vent (Left side of unit)*



*Figure 16 – Vent Filter Removal*



# Control Board Diagnostics

**Important Note:** To prevent death, personal injury or property damage due to electrical shock, only qualified service personnel are authorized to use the diagnostic box or this procedure.

## Introduction

The Trane PTAC is equipped with a fault indicator LED that will notify the owner when an internal control board error has occurred. The LED is located on the control board itself and is covered by the low-voltage access cover. Following is a chart detailing the diagnostic fail codes.

<b>ON</b>	Normal
<b>OFF</b>	No power / failed board

### Fault Codes

1	Compressor Failure
2	Blown Fuse
3	Mode Switch
4	Setpoint Switch
5	Incorrect Thermostat Wiring
6	Indoor Air Thermistor
7	Indoor Coil Thermistor
8	Outdoor Air Thermistor (PTHP Only)
9	Outdoor Coil Thermistor (PTHP Only)

**LED Flash Rate** 0.25 sec ON per flash, 0.25 sec OFF between flashes, 2.00 sec OFF between codes

## Unit Preparation

1. Grasp the cabinet front as shown.

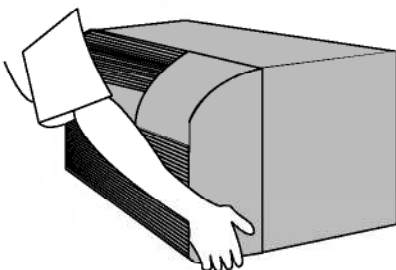

2. Pull the bottom of the cabinet front away from the chassis until the retaining clips disengage.

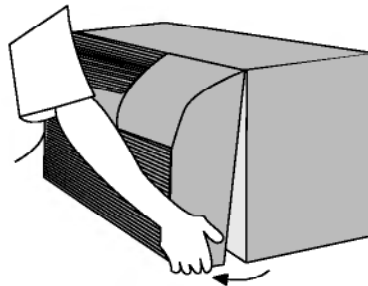

3. Lift the cabinet front off the chassis.
4. Remove the low-voltage access cover by removing the screw securing it to the control panel cover.
5. Disconnect power to the unit.
6. Lifting the front edge of the escutcheon, slide the tabs at the top of the escutcheon out of the retaining holes and remove the escutcheon.
7. Remove the unit control knobs by gently pulling the knobs off the control shafts.
8. To gain access in side the control cover, after removing the knobs and escutcheon, remove the two screws holding the control cover in position. The control cover can be lifted off. Refer to disassembly procedures for more information.

## ▲ WARNING!

### Live Electrical Warning!

During installation, testing, servicing and troubleshooting of this product, it may be necessary to work with live electrical components. Have a qualified licensed electrician or other individual who has properly trained in live electrical components perform these tasks. Failure to follow all electrical safety precautions when exposed to live electrical components could result in death or serious injury.

### Disassembly to access Control Board Line Voltage Terminals

# Refrigeration System

---

## Refrigeration System Service

---

**Important Note:** *Brazing requires high temperatures. Take precaution to protect against personal injury or property damage.*

**To avoid the risk of fire, the refrigeration system must be kept free from contamination due to the presence of air. Follow these instructions exactly.**

**To avoid the risk of burns, property damage, personal injury or death, do not plug in this product or apply power to the compressor if the compressor terminal cover has been removed or is not firmly in place.**

---

### **Important Note:**

Effective July 1, 1992 before opening any refrigerant system it is the responsibility of the service technician to capture the refrigerant for safe disposal.

Refer to the cooling and heater performance charts in this section for capacity test procedure.

A step-by-step procedure for determining source of trouble, suggested method and normal values are provided in the Diagnosis Charts.

Service operations requiring opening of the hermetically sealed refrigeration system should be taken to a well equipped shop where special equipment for evacuating, dehydrating, charging and testing is available. The following equipment is necessary:

- Nitrogen of no more than 0.0012 grains of moisture.
- Vacuum pump capable of evacuating to a minimum of 50 microns.
- Micron gauge to check vacuum.
- Refrigerant charging cylinder accurate to within 1/4 oz.
- Electronic leak detector
- Electrical equipment to test compressors, capacitors, voltage relays and overload protectors
- Volt-meter, ammeter, and watt-meter
- Silver soldering and brazing equipment - Pinch off tools ¼ in to 5/8 in
- Thermocouple tester

# Refrigeration System

*Refrigeration Sealed System – Heat Pump (Air Conditioning Model)*

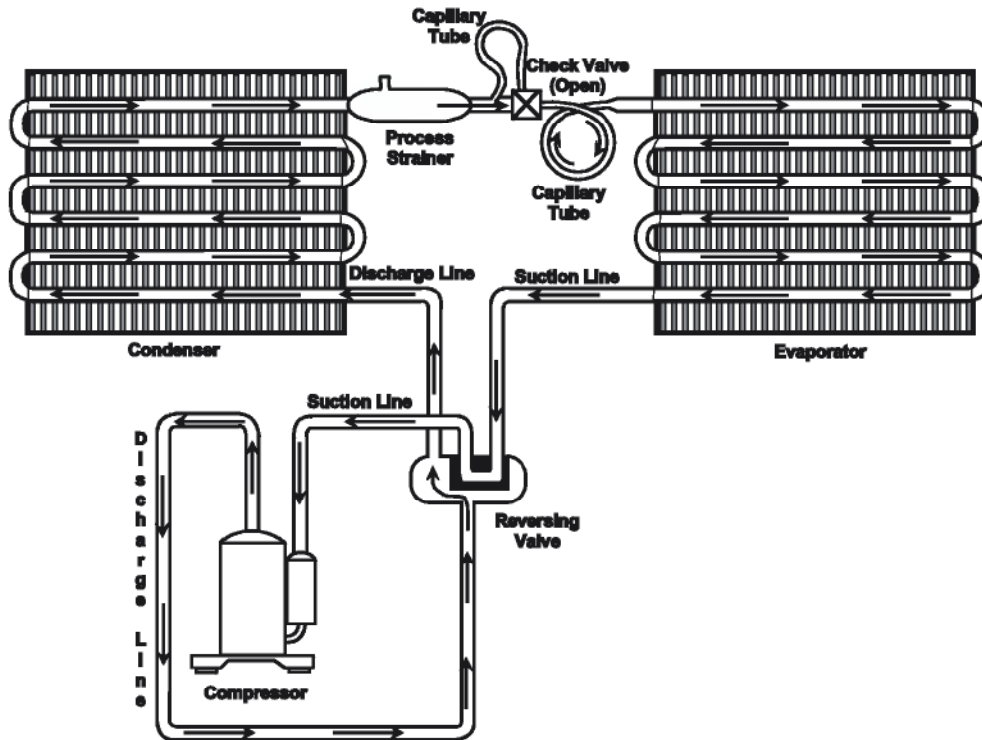

*Refrigeration Sealed System – Heat Pump (Heat Pump Model)*

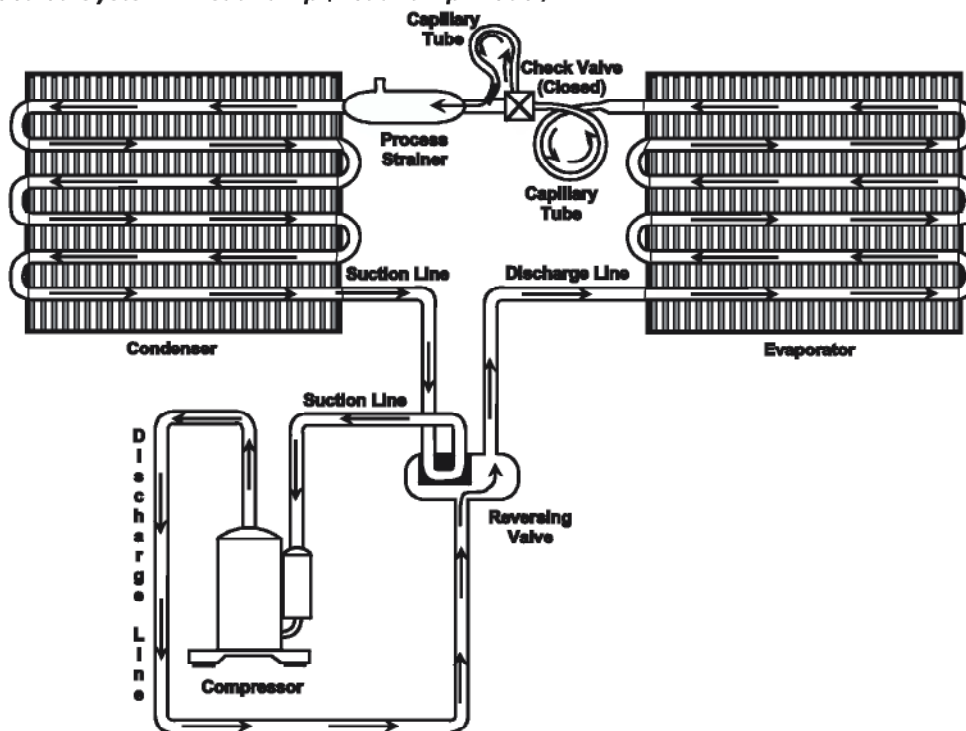

# Refrigeration System

---

## Dehydrating and Evacuating Refrigeration System

A rather popular misconception exists that since air conditioners normally operate with a refrigerant temperature above 32°F, moisture in the system is harmless. Nothing could be further from the truth. Oxygen from moisture plus normal compressor and motor heat reacts chemically with the refrigerant and oil to form corrosive hydrochloric and hydrofluoric acids. These acids contribute to the break down of motor winding insulation and the corrosion of compressor working parts and cause unnecessary compressor failure. Sludge, which is a residue of the chemical reaction, coats all compressor parts, the inside of refrigerant tubing, and may even restrict refrigerant flow through the capillary tube(s).

### Leak Testing

Refrigerant leaks are best detected with a halide or electronic leak detector.

The importance of careful leak testing cannot be over emphasized. Undetected leaks invariably lead to repeated calls and eventually result in system contamination, restrictions and burned out compressors.

For a system that contains a refrigerant charge and is suspected of having a leak, stop the operation, check all tubing and fittings. Soap suds may also be used.

**Note:** The flame of the halide detector will glow green in the presence of R22 refrigerant.

If a leak is detected, do not attempt to apply more brazing material to the joint. Recover the charge, unbrazed the joint, clean and rebraze.

For a system that has been newly repaired and does not contain a charge, connect a cylinder of refrigerant, through a gauge manifold, to the process tube of the compressor and liquid line strainer. Open the valve on the cylinder and manifold and allow the pressure to build up within the system. Check for and handle leaks as described above.

After the test has been completed, recover the test charge, evacuate the system, and recharge with clean refrigerant.

### Brazing

---

**Important Note: Brazing requires high temperatures. Take precaution to protect against personal injury or property damage.**

---

Satisfactory results require cleanliness, experience and the use of proper material and equipment.

The connections to be brazed must be properly sized, free of rough edges and clean.

The generally accepted materials are:

**SIL-FOS** (Alloy of 15% silver, 80% copper, 5% phosphorus) is used without flux on copper to copper. **DO NOT USE FOR A COPPER TO STEEL CONNECTION.** Recommended heat is approximately 1400°F.

**SILVER SOLDER** (Alloy of 30% silver, 38% copper, 32% zinc) is used with fluoride base flux on copper to steel, brass to copper, steel to steel, brass to steel. Recommended heat is approximately 1200°F.

# Refrigeration System

---

## Evacuation

**Important Note:** *To prevent severe burns, do not allow the sludge or oil to contact the skin.*

### Important Note:

Effective July 1, 1992. Before opening any refrigerant system it is the responsibility of the service technician to capture the refrigerant for safe disposal.

**This is the most important part of the entire service procedure. The life and efficiency of the equipment is dependent upon the thoroughness exercised by the serviceman when evacuating air (non-condensables) and moisture from the system.**

Air in the system causes high condensing temperature and pressure, resulting in increased power input and reduced performance.

Moisture chemically reacts with the refrigerant and oil to form corrosive hydrofluoric and hydrochloric acids. These attack motor windings and parts, causing breakdown.

The equipment required to thoroughly evacuate the system is a high vacuum pump, capable of producing a vacuum equivalent to 50 microns, and a thermocouple vacuum gauge to give a true reading of the vacuum in the system.

**Note:** Never use the system compressor as a vacuum pump or run when under a high vacuum. Motor damage could occur.

1. Connect the vacuum pump, vacuum tight manifold set with high vacuum hoses, thermocouple vacuum gauge and charging cylinder.
2. Connect the low side line to the process tube of the compressor.

3. Connect the high side line to the process tube of liquid line strainer.

**Note:** If either process tube is not long enough to receive the compression or flare fitting and still leave room for a pinch-off, swag the tube and braze in an extra length of tubing.

4. Start the vacuum pump and open shut off valve to the high vacuum gauge manifold only. After the compound gauge (low side) has dropped to approximately 29 inches of vacuum, open the valve to the vacuum thermocouple gauge. See that the vacuum pump will bank-off to a minimum of 50 microns. A high vacuum pump can only produce a good vacuum if its oil is not contaminated.
5. If the vacuum pump is working properly, close the valve to the vacuum thermocouple gauge and open the high and low side valves or the high vacuum manifold set. With the valve on the charging cylinder closed, open the manifold valve to the cylinder.
6. Evacuate the system to at least 29 inches gauge before opening valve to thermocouple vacuum gauge.
7. Continue to evacuate to a minimum of 250 microns. Close valve pump and watch rate of rise. If vacuum does not rise above 1500 microns in three minutes, system can be considered properly evacuated.
8. If thermocouple vacuum gauge continues to rise and levels off at about 5000 microns, moisture and non-condensables are still present. If gauge continues to rise a leak is present. Repair and re-evacuate.
9. Close valve to thermocouple vacuum gauge and vacuum pump. Shut off pump and prepare to charge.

# Refrigeration System

---

## Charging

Charge the system with the exact amount of refrigerant.

Refer to the unit nameplate for the correct refrigerant charge. An inaccurately charged system will cause future problems.

1. When using an ambient compensated calibrated charging cylinder, allow liquid refrigerant only to enter the high side.
2. After the system will take all it will take, close the valve on the high side of the manifold.
3. Start the system and charge the balance of the refrigerant through the low side. Do not charge in a liquid form.
4. Close the low side valve on the manifold and pinch-off both process tubes. Remove the manifold set, crimp shut the open ends of the process tubes and braze.
5. Recheck for refrigerant leaks.

## Refrigerant

Do not use a refrigerant other than that shown on the unit nameplate.

All precautionary measures recommended by the refrigerant manufacturers and suppliers should be observed.

## Line Piercing Valves

Line piercing valves may be used for diagnosis but are not suitable for evacuating or charging due to the minute holes pierced in the tubing.

Line piercing valves must not be left on the refrigerant system. The connection between the valve and the refrigerant tubing is not hermetically sealed and will eventually leak.

## Open Lines

During any processing of the refrigeration system the lines should never be left open to atmosphere since water vapor will enter and add to the problem of proper evacuation.

## Operating Test

The final step in a successful repair is an accurate operating test. Follow the Cooling and Heating Performance tests provided to make sure the product is again performing to design standards.

---

***Important Note: Never test operation without the unit in the wall sleeve. A serious change in design specifications for air movement through the evaporator and condenser compartments, causing the fan motor to over heat and the refrigeration system to become unbalanced will occur when the unit is not installed in the wall sleeve.***

---

# Refrigeration System

## ⚠ WARNING!

### Hazardous Voltage!

Disconnect all electric power, including remote disconnects before servicing. Follow proper lockout/tagout procedures to ensure the power can not be inadvertently energized. Failure to disconnect power before servicing could result in death or serious injury.

## Cooling Performance Test

### Thermometers

The following precautions are necessary in observing the thermometer readings in the cooling performance test.

1. Use two accurately calibrated refrigeration type thermometers or a thermocouple potentiometer.
2. Thermometers are affected by body heat or changes in air flow. Therefore, the thermometers must be secured in proper locations with masking tape, wire or other applicable retainers.
3. Readings should be observed without touching or moving the thermometers.

### Sling Psychrometer

The sling psychrometer is used to obtain the wet bulb temperature in determining the percent relative humidity.

To obtain the wet bulb operate the sling psychrometer as follows:

- Saturate the wick (only once during procedure of obtaining wet bulb readings) with clean water slightly below room temperature.
- Psychrometer reading should be acquired five to six feet in front of the unit and approximately four feet off the floor.

**Note:** Direct discharge airflow away from the sling psychrometer.

The cooling performance test should not be employed when outside temperatures are 20° below that of the room. Best results are obtained when the test is conducted under peak load conditions.

The air conditioner must operate at least 20 minutes on the High Cool position before testing.

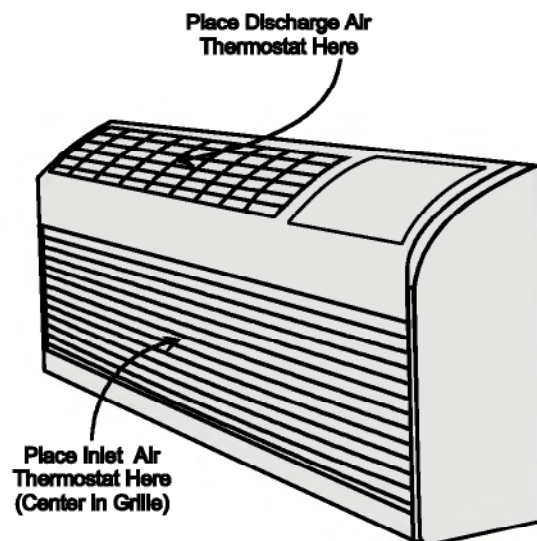

## Refrigeration System

---

### Cooling Performance Test

The following temperature must be recorded for the cooling performance test:

- a. Dry bulb temperature of return air at conditioner. Locate thermometer as illustrated on previous page.
- b. Dry bulb temperature of discharge air. Thermometer has to be located as illustrated on previous page.
- c. The dry bulb thermometer temperature on the sling psychrometer should be plus or minus 1°F within reading obtained on thermometer in the return air. Check wet bulb temperature on sling psychrometer and record same.
- d. After the wet bulb temperature, dry bulb temperature, and return air temperature have been recorded, proceed to calculate the temperature difference as follows.
- e. Subtract temperature obtained in Step B from temperature obtained in Step A. The remainder temperature is used to calculate from the Cooling Change of Temperature in **Diagnostic Charts**.

**Example:** Assume a PTHD1501 unit is under test and the temperature readings indicated below were obtained.

1. Return air dry bulb temperature: 80°F, Step A.
2. Discharge air dry bulb temperature: 69°F, Step B.
3. Return air, wet and dry bulb temperature as recorded in Step C: Dry Bulb 80°F, Wet Bulb 75°F.

4. In left hand column of Cooling Capacity Charge headed Dry Bulb, find the 80° value.

5. In column headed Wet Bulb find the 75° value and find the value "8 -13" in the cooling range column under the Model "PTHD1501".

This data shows that the temperature of the air passing through the cooling coil is reduced at least 8°F but not more than 13°F. This example unit is operating normally for the existing conditions.

For the example unit under test, the temperature difference was 11°F (80°F, return air, minimum 69°F discharge air). Since the value is within the listed cooling range 8 - 13, this unit is considered to be operating normally.

---

**Important Note: Never test operation without the unit in the wall sleeve. A serious change in design specifications for air movement through the evaporator and condenser compartments, causing the fan motor to over heat and the refrigeration system to become unbalanced will occur when the unit is not installed in the wall sleeve.**

---

### **⚠ WARNING!**

#### **Hazardous Voltage!**

**Disconnect all electric power, including remote disconnects before servicing. Follow proper lockout/tagout procedures to ensure the power can not be inadvertently energized. Failure to disconnect power before servicing could result in death or serious injury.**

# Refrigeration System

---

**For The Cooling Wattage Tests the following additional readings must be recorded after the unit under test is interconnected with a wattmeter.**

- Outdoor air dry bulb temperature. Avoid direct exposure of thermometer to sunlight or to hot condenser discharge air.
- Total watts input, measured by wattmeter or calculate by multiplying applied voltage by the unit's amp draw.

### Calculating Procedure

1. Locate the outside air dry bulb temperature obtained in the first column of the Cooling Wattage Test.
2. Locate in the second column the return air wet bulb temperature obtained in the Cooling Performance Test.
3. The total watts input should come between minimum and maximum values indicated for each model.

### Example:

Assume that a PTHD1501 is again under test. Proceed as follows and observe test readings as simultaneously as possible.

1. Outdoor air dry bulb temperature reading - 95°F.
2. Check watts input - 1510.
3. Wet bulb temperature as described in Step C; 75°F.

In the column headed Outdoor Air Dry Bulb Temperature of the Cooling Wattage Test find the 95°F value. Read to the right from the 95°F value and find the room wet bulb temperature (75°F).

Read to the right from the 75°F W.B. value in the PTHD1501 column and note the minimum and maximum wattage of 1460 - 1575.

Since the wattage reading (1510) obtained in the test is within the prescribed range, the total power input in watts is considered to be normal.

### Electric Heat Test

For the electric heat test, the following readings must be recorded after the unit is interconnected with a wattmeter or by recording the total amp draw to the unit.

**Note:** Cabinet front must be in place during this test.

- Record supply voltage to unit.
- Operate unit in highest heat setting.
- Record wattage recorded on wattmeter or total amp draw to unit.
- Refer to the Electric Heat Capacity and Electrical Data on page 41 (whichever is applicable for voltage rating on the unit being tested.)
- The total watts or amps recorded should fall within the minimum and maximum watts/amps listed on these charts.

# Refrigeration System

---

**Example:**

Assume that a PTHD1501 230/208V with 3.5 kW electric heater is under test.

1. Supply voltage as recorded - 208V.
2. Watts recorded -2750W or Amps recorded - 13.5 Amps.
3. Locate the readings listed on page 11. You will note that these readings fall within the voltage, watts and amp draw minimum and maximum ranges listed and therefore the unit heating performance would be considered normal.

**Heating Power Consumption Test (Heat Pump Mode Only)**

For the heating wattage, the following readings must be recorded after the unit is interconnected with a wattmeter.

- Outside coil inlet air dry bulb temperature.
- Inside coil inlet air dry bulb temperature.
- Total watts input measured by wattmeter.

**Calculating procedure**

1. Locate temperature obtained in Step A of cooling performance test in first column of Heating Wattage Chart.
2. Locate in second column the inside coil inlet dry bulb temperature.
3. The total watts input should come between minimum and maximum values indicated for each model.

**Example:**

Assume that a PTHD1501 is under test. Proceed as follows and observe test readings as simultaneously as possible.

1. Outside coil inlet dry bulb temperature readings as described above: 45°F.
2. Check watts input: 1370 W
3. Inside coil inlet dry bulb temperature reading as described in Step B: 75°F.

Read to the right from the 75° inside coil inlet dry bulb value in the column and note the minimum and maximum wattage of 1335 - 1470.

Since the wattage reading (1370) obtained in the test is within the prescribed range, the total power input in watts is considered to be normal.

# Refrigeration System

## Capacitor Check

### Resistance Check

1. Discharge capacitor and remove wire leads.

### ⚠ WARNING!

Discharge capacitor through a 20 to 30 ohm resistor before handling.

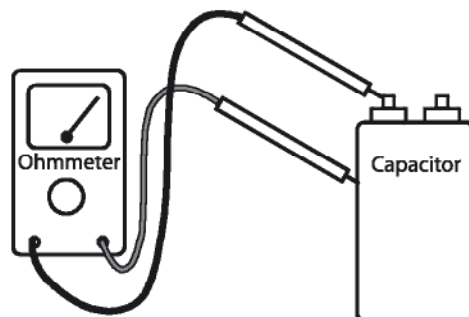
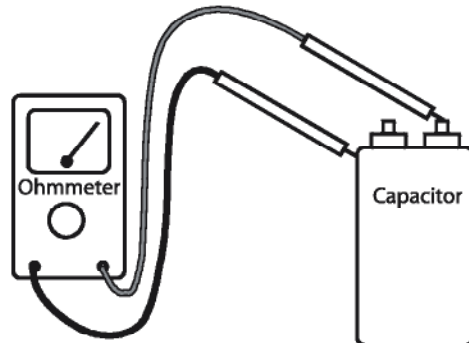
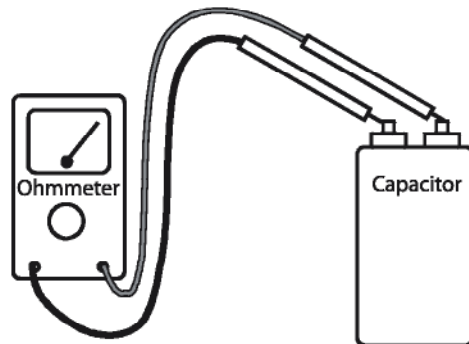

## Testing Capacitor Resistance

2. Set an ohmmeter on its highest ohm scale and connect the leads to the capacitor.
  - a. Good Condition - indicator swings to zero and slowly returns to infinity. (Start capacitor with bleed resistor will not return to infinity. It will still read the resistance of the resistor).
  - b. Shorted - indicator swings to zero and stops there - replace.
  - c. Open - no reading - replace. (Start capacitor would read resistor resistance).
3. Testing for ohms between either capacitor terminal and the capacitor body must show infinite ohms.

## Component Tests

### ⚠ WARNING! Hazardous Voltage!

Disconnect all electric power, including remote disconnects before servicing. Follow proper lockout/tagout procedures to ensure the power can not be inadvertently energized. Failure to disconnect power before servicing could result in death or serious injury.

### Capacitance Check

Using a hookup as shown below, take the amperage and voltage readings and use them in the formula below the diagram.

### ⚠ WARNING! Hazardous Voltage!

Disconnect all electric power, including remote disconnects before servicing. Follow proper lockout/tagout procedures to ensure the power can not be inadvertently energized. Failure to disconnect power before servicing could result in death or serious injury.

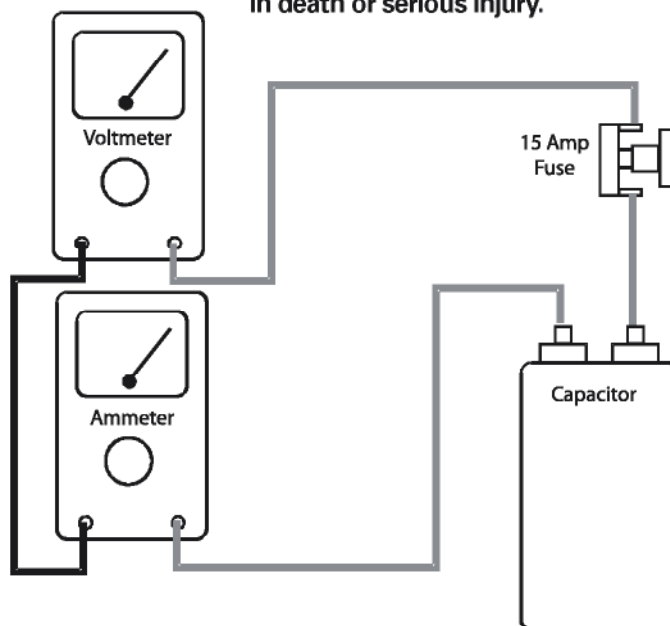

### Testing Capacitance

$$\text{Capacitance (MFD)} = \frac{2650 \times \text{Amperage}}{\text{Voltage}}$$

If the value obtained is not within 10% of the rating printed on the capacitor, replace.

### Overloads

1. With no power to the unit, remove the overload lead from the compressor terminal.
2. Using an ohmmeter: Test continuity between terminals of the overload. If not continuous, the overload is open, replace the overload.

### Compressor Windings

**Important Note:** To prevent death, personal injury or property damage due to electrical shock, do not connect electrical power to this unit or to the compressor if the compressor terminal cover has been removed or is not firmly in place.

If the test indicates shorted, grounded or open windings, see procedure for the next steps to be taken.

### Resistance Test

1. With no power, remove the leads from the compressor terminals.
2. Touch the leads of an ohmmeter to terminals C-S, start windings and C-R, run winding.

If either winding does not test continuous, replace the compressor.

# Component Tests

## Compressor Ground Test

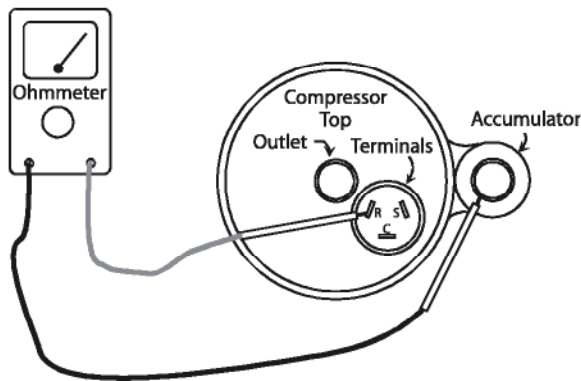

## Ground Test

With no power and compressor leads removed:

Set an ohmmeter on its highest scale. Touch one lead to the compressor body (clean point of contact, as a good connection is a must) and the other probe to each compressor terminal in turn. If a reading is obtained, then the compressor is grounded and must be replaced.

If the voltage, capacitor, overload and motor windings test fail to show the cause for failure:

1. With no power, wire a test cord to line voltage (Line & N).

**Note:** The wire size of the test cord must equal the line size, and the fuses in the test line must be of the proper size and type.

## Test Cord Connections

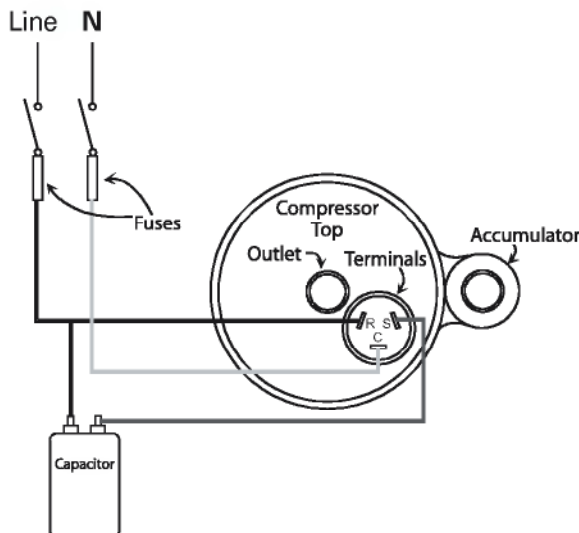

2. Connect a good capacitor of the right MFD and voltage rating into the circuit as shown.
3. Carefully apply line voltage.
  - a. If the compressor starts and continues run, the cause for failure is somewhere else in the system.
  - b. If the motor fails to start - replace. Since all single phase compressors are of the permanent split capacitor design the high and low side pressure must be approximately equal or the low torque compressor may not start.

## Component Tests

### ▲ **WARNING!** **Hazardous Voltage!**

Disconnect all electric power, including remote disconnects before servicing. Follow proper lockout/tagout procedures to ensure the power can not be inadvertently energized. Failure to disconnect power before servicing could result in death or serious injury.

#### Indoor Coil and Indoor Air Thermistors:

1. Remove the Indoor Coil Thermistor leads from the circuit board.
2. Check the resistance of the Indoor Coil Thermistor against the table on the next page. The leads of the ohm meter will need to contact the ends of the thermistors that connect to the board.
3. Replace the Indoor Coil Thermistor if it does not test as above.

#### Outdoor Coil and Outdoor Air Thermistors:

1. Remove the outdoor coil thermistor leads from the circuit board.
2. Check the resistance of the Outdoor Coil Thermistor against the table on the next page. The leads of the ohm meter will need to contact the ends of the thermistors that connect to the board.
3. Replace the outdoor coil thermistor if it does not test as above.

#### Heater Assembly With Power OFF to the unit and heater:

1. Remove the heaters in question and visually inspect the element for broken condition. Refer to the disassembly procedures for information on disassembling the heater.

2. Test the thermal fuse (one time fuse). If open, replace the heater assembly.

#### Reversing Valve

Occasionally the reversing valve may stick in the heating or cooling position or in the mid-operation.

When stuck in the mid-position, part of the discharge gas from the compressor is directed back to the suction side resulting in excessively high suction pressure.

Check the operation of the valve by starting the system and switching the operation from COOLING to HEATING and then back to COOLING.

If no voltage is registered to the coil, check the operation of the reversing relay and the continuity of the connecting wires.

If voltage is registered at the coil, tap the valve body lightly while switching the system from HEATING to COOLING etc. If this fails to cause the valve to switch position, remove the coil connector cap and wiring and test the continuity of the valve coil. If the coil does not test continuous replace it.

If the valve is inoperative, replace.

#### Component Replacement

Replacement of the compressor, evaporator, condenser, capillary tubes and reversing valve must be in accordance with accepted service practices. These procedures include a complete evacuation of both high and low sides, and changing of the capillary tube assembly whenever the refrigerant system is opened.

Before replacing a component in the sealed system, make sure that the cause for complaint does not lie in the electrical circuit, control, overload or is due to some other reason. The serviceman must be familiar with the operational characteristics of the product and should not jump to conclusions.

#### Temperature-Actuated Drain Valve (PTHP Only)

The Trane PTHP will be equipped with a temperature-actuated drain valve located in the base pan. As the outdoor ambient decreases to 55°F, the drain valve will begin to open. The valve will be completely open when the outdoor ambient temperature falls to 50° F.

### ▲ **WARNING!** **Live Electrical Warning!**

During installation, testing, servicing and troubleshooting of this product, it may be necessary to work with live electrical components. Have a qualified licensed electrician or other individual who has properly trained in live electrical components perform these tasks. Failure to follow all electrical safety precautions when exposed to live electrical components could result in death or serious injury.

---

**Important Note: Set the temperature control all the way counter-clockwise to prevent the fan from suddenly coming on and endangering the servicer's hands.**

---

# Component Tests

## 10K OHMS @ 25°C

°C	Multiplier	°C	Multiplier	°C	Multiplier	°C	Multiplier	°C	Multiplier
-40	33.6	8	2.1918	56	0.2878	104	0.06085	152	0.0175
-39	31.449	9	2.0883	57	0.2774	105	0.0592	153	0.017
-38	29.452	10	1.9903	58	0.2675	106	0.0576	154	0.0166
-37	27.597	11	1.8972	59	0.2579	107	0.05605	155	0.0162
-36	25.873	12	1.809	60	0.2488	108	0.05456	156	0.0158
-35	24.27	13	1.7255	61	0.24	109	0.0531	157	0.0154
-34	22.761	14	1.6464	62	0.2315	110	0.0517	158	0.0151
-33	21.357	15	1.5714	63	0.2235	111	0.05027	159	0.0148
-32	20.051	16	1.5	64	0.2157	112	0.04889	160	0.0145
-31	18.834	17	1.4323	65	0.2083	113	0.04755	161	0.0141
-30	17.7	18	1.3681	66	0.2011	114	0.04625	162	0.0138
-29	16.6342	19	1.3071	67	0.1943	115	0.045	163	0.0135
-28	15.6404	20	1.2493	68	0.1876	116	0.04372	164	0.0132
-27	14.7134	21	1.1942	69	0.1813	117	0.04248	165	0.013
-26	13.8482	22	1.1418	70	0.1752	118	0.04128	166	0.0127
-25	13.0402	23	1.0921	71	0.1693	119	0.04012	167	0.0125
-24	12.2807	24	1.0449	72	0.1637	120	0.039	168	0.0122
-23	11.571	25	1	73	0.1582	121	0.03793	169	0.012
-22	10.9075	26	0.9571	74	0.153	122	0.0369	170	0.0118
-21	10.2868	27	0.9164	75	0.148	123	0.0359	171	0.0115
-20	9.706	28	0.8776	76	0.1431	124	0.03494	172	0.0113
-19	9.1588	29	0.8407	77	0.1385	125	0.034	173	0.0111
-18	8.6463	30	0.8056	78	0.134	126	0.03315	174	0.0109
-17	8.1662	31	0.772	79	0.1297	127	0.03233	175	0.0107
-16	7.7162	32	0.7401	80	0.1255	128	0.03153	176	0.0104
-15	7.294	33	0.7096	81	0.1215	129	0.03075	177	0.0102
-14	6.8957	34	0.6806	82	0.1177	130	0.03	178	0.01
-13	6.5219	35	0.653	83	0.114	131	0.02926	179	0.0098
-12	6.1711	36	0.6266	84	0.1104	132	0.02854	180	0.0097
-11	5.8415	37	0.6014	85	0.107	133	0.02784	181	0.0094
-10	5.5319	38	0.5774	86	0.1037	134	0.02716	182	0.0092
-9	5.2392	39	0.5546	87	0.1005	135	0.0265	183	0.009
-8	4.964	40	0.5327	88	0.0974	136	0.02586	184	0.0088
-7	4.7052	41	0.5117	89	0.0944	137	0.02525	185	0.0087
-6	4.4617	42	0.4918	90	0.0915	138	0.02465	186	0.0085
-5	4.2324	43	0.4727	91	0.08885	139	0.02407	187	0.0083
-4	4.0153	44	0.4544	92	0.0861	140	0.0235	188	0.0082
-3	3.8109	45	0.437	93	0.08355	141	0.02295	189	0.008
-2	3.6182	46	0.4203	94	0.08108	142	0.02242	190	0.0079
-1	3.4367	47	0.4042	95	0.0787	143	0.0219	191	0.0077
0	3.2654	48	0.3889	96	0.07641	144	0.02139	192	0.0076
1	3.103	49	0.3743	97	0.0742	145	0.0209	193	0.0074
2	2.9498	50	0.3603	98	0.07206	146	0.02039	194	0.0073
3	2.8052	51	0.3469	99	0.07	147	0.0199	195	0.0072
4	2.6686	52	0.334	100	0.068	148	0.01942	196	0.007
5	2.5396	53	0.3217	101	0.06612	149	0.01895	197	0.0069
6	2.4171	54	0.3099	102	0.0643	150	0.0185	198	0.0067
7	2.3013	55	0.2986	103	0.06255	151	0.01801	199	0.0066
								200	0.0065

# Disassembly Procedures

## ▲ WARNING!

### Hazardous Voltage!

Disconnect all electric power, including remote disconnects before servicing. Follow proper lockout/tagout procedures to ensure the power can not be inadvertently energized. Failure to disconnect power before servicing could result in death or serious injury.

## Disassembly Procedures

### Front Removal

1. Grasp the cabinet front as shown.

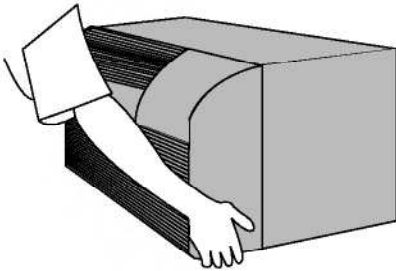

2. Pull the bottom of the cabinet front away from the chassis until the retaining clips disengage.

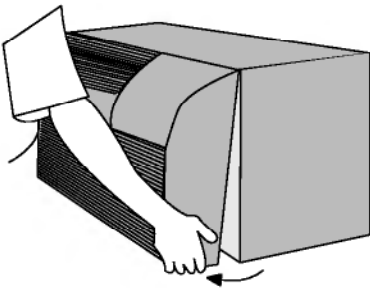

3. Lift the cabinet front off the chassis. Reverse this procedure to reinstall the cabinet front.

### Chassis

1. Disconnect power to the unit.
2. Remove the front cover.
3. Remove three screws on each side of the chassis, securing the chassis to the wall sleeve.

4. Carefully slide chassis out of wall sleeve, placing on floor or protected cart.

### Escutcheon, Control Knobs, Control Panel Cover, Control Board Removal

1. Remove the front cabinet.
2. Remove the control escutcheon panel by lifting the bottom portion and pulling the tabs away from the top portion.
3. Remove the control knobs by gently pulling straight up and away from the control board.
4. Remove 2 screws, as shown below, to gain access into the control panel cover. Grip the cover between the two screws and gently pull up on the cover to remove. The control panel cover has now been removed.

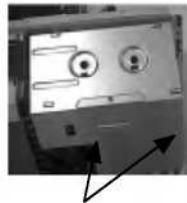

5. Remove the wire junction box cover by removing the four screws securing it to the partition panel above the control panel. This will expose the wiring connectors that connect all the PTAC devices to the control board. If the board is being replaced, remove the wiring from the control board and not the connectors. If a PTAC device (fan motor, compressor) is being replaced, the control wiring can be disconnected from the actual connectors in the wire junction box.
6. Remove the two screws mounting the control to the PTAC. The screws are located at the bottom of the control board securing the control board housing to the PTAC. The control board has now been removed.

### Power Cord Removal

1. Remove the front cabinet.
2. Remove the escutcheon, control knobs and control panel.
3. Remove three screws as shown below as well as the control board wiring to remove the control box.
4. Once inside the control box, remove the power cord strain relief and disconnect the power cord from the terminal block.

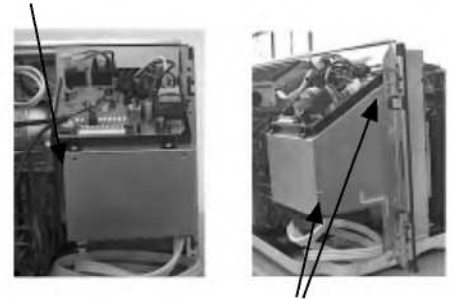

### Capacitor Removal

1. Remove the front cabinet.
2. Remove the escutcheon, control knobs, control panel cover and disconnect the wiring to the control board.
3. Remove the control box. Refer to the disassembly of the power cord for instructions on removing the control box.
4. Remove the screw securing the capacitor to the control box.

## ▲ WARNING!

### Hazardous Voltage!

Disconnect all electric power, including remote disconnects before servicing. Follow proper lockout/tagout procedures to ensure the power can not be inadvertently energized. Failure to disconnect power before servicing could result in death or serious injury.

# Disassembly Procedures

## Heater Assembly Removal

1. Remove the cabinet front.
2. Remove the three screws securing the discharge screen to the chassis. Shown below.

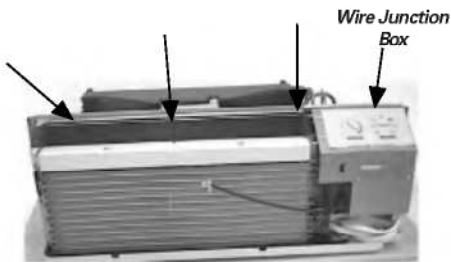

3. Remove the wire junction box cover by removing four screws near the top of the partition panel above the control panel. Disconnect the heater wiring connector.
4. To remove the heater/discharge deck assembly, remove two screws on the left and one on the right side of the discharge deck. Shown below.

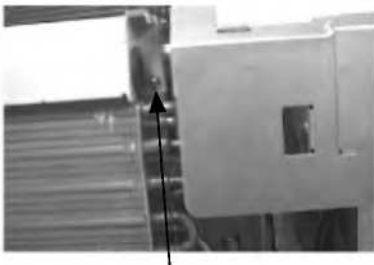
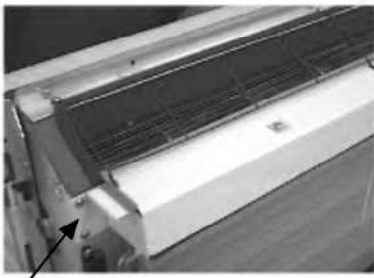

5. Gently lift the heater/discharge deck assembly out of the unit.

## Removing the Indoor Coil and Indoor Air Thermistors

1. Remove the front cabinet.
2. Remove the escutcheon, control knobs, and control panel.
3. Disconnect the Indoor Coil/Air Thermistor wiring from the control board.
4. Locate the Indoor Coil/Air Thermistor on the suction tube or evaporator. Gently pull the thermistor from the housing.
5. Remove the Indoor Coil/Air Thermistor from the unit.

## Removing the Outdoor Coil and Outdoor Air Thermistors

1. Remove chassis from the wall.
2. Remove the front cabinet.
3. Remove the escutcheon, control knobs, and the control panel.
4. Disconnect the Outdoor Coil/Air Thermistor wiring from the control board.
5. Gently pull the thermistor from the housing.
6. Remove the Outdoor Coil/Air Thermistor from the unit.

## Evaporator Removal

**Note: The evaporator is not a replaceable part. Contact the Zone Products Business Unit for additional information.**

1. Remove the chassis from the wall.
2. Remove the front cabinet.
3. Remove the escutcheon, control knobs, control panel and control box assemblies. (Refer to the power cord disassembly for instructions on removing the control box.)
4. Remove the heater/discharge deck assembly. (Refer to the Heater disassembly)

5. Remove the Indoor Coil Thermistor from the evaporator suction tube. (Refer to the Indoor Coil Thermistor disassembly instructions) Remove the indoor air thermistor from the evaporator coil.
6. Recapture the system refrigerant.
7. Remove 2 screws from both the left and right side of the unit securing the evaporator to the mid-partition panel.
8. Remove the evaporator inlet and suction line tubing from the evaporator.
9. Remove the evaporator.

## Condenser Removal

**Note: The condenser is not a replaceable part. Contact the Zone Products Business Unit for additional information.**

1. Remove the condenser shroud by removing two screws on each side of the shroud securing it to the condenser, two screws on the bottom portion of the shroud securing it to the basepan, and four total screws securing the shroud to the partition bracket at the top of the unit.
2. Remove one screw on the right side of the unit (if you are looking at the back of the PTAC) toward the bottom of the basepan.
3. Capture the refrigerant in the system.
4. Remove the discharge and condenser out tubing from the condenser.
5. Remove the condenser.

## Disassembly Procedures

---

### Indoor Fan and Motor

1. Remove the chassis from the wall.
2. Remove the front cabinet.
3. Remove the heater/discharge deck assembly. (Refer to the heater disassembly instructions)
4. Remove the escutcheon, control knobs, control panel cover and control box. Remember to disconnect the control wiring. Refer to the power cord disassembly for instructions on disassembling the control box.

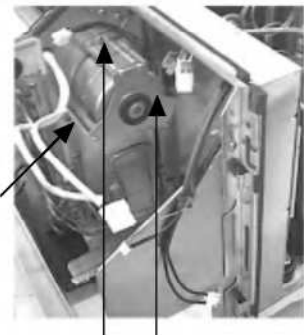

5. Remove the indoor fan motor bracket screws (3) as shown.
6. Remove the set screw (you will need a long allen wrench) securing the indoor fan to the motor shaft and remove the indoor fan and motor.

### Outdoor Fan and Motor

1. Follow the directions for removing the condenser except don't braze or remove the tubing connecting to the condenser. Capturing the system refrigerant is also not necessary.
2. Remove the screw on the right side of the unit (If you are looking at the back of the PTAC) toward the bottom of the PTAC near the lip of the basepan.
3. Lift the condenser up and over the lip of the basepan and move just enough to gain access to the outdoor fan and motor. Be careful not to damage the bottom of the condenser by sitting it on the lip of the basepan. Also, use caution when bending the condenser to gain access to the outdoor fan and motor. The tubing is very fragile and must be treated with care.
4. With a pair of pliers, remove the clamp securing the outdoor fan to the fan shaft.
5. Remove the fan motor by removing the two screws securing it to the fan motor bracket.
6. Disconnect the fan motor wiring from the control by removing the wire junction box cover on the partition panel above the control panel cover.

# Specifications

## Air Conditioner Performance Data

	PTED 07				PTED 09				PTED 12				PTED 15		
Voltage (V)	115	208	230	265	115	208	230	265	115	208	230	265	208	230	265
<b>Cooling Data</b>															
Cooling Capacity (Btu/h)	7,200	7,000	7,200	7,600	9,300	9,000	9,300	9,300	12,000	11,700	12,000	12,000	14,300	14,600	14,600
Cooling Amps (A)	5.3	2.8	2.6	2.4	7.3	3.9	3.6	3.2	9.7	4.8	5.2	4.2	7.1	6.5	5.7
Cooling Power (W)	590	560	575	625	810	785	810	810	1070	1045	1070	1070	1400	1430	1460
EER (Btu/h/Watt)	12.2	12.5	12.5	12.2	11.5	11.5	11.5	11.5	11.2	11.2	11.2	11.2	10.2	10.2	10.0
Moisture Removal (Pts/h)	2.0	2.0	2.0	2.0	2.6	2.6	2.6	2.6	3.6	3.6	3.6	3.6	4.5	4.5	4.5
<b>Heat Pump Heating Data</b>															
Heating Capacity (Btu/h)	*	*	*	*	*	*	*	*	*	*	*	*	*	*	*
Heating Amps (A)	*	*	*	*	*	*	*	*	*	*	*	*	*	*	*
Heating Power (W)	*	*	*	*	*	*	*	*	*	*	*	*	*	*	*
COP (W/W)	*	*	*	*	*	*	*	*	*	*	*	*	*	*	*
<b>Airflow</b>															
Indoor CFM (Wet) @0.3ESP (Hi)	210	185	215	210	245	230	260	245	315	300	330	315	315	355	335
Indoor CFM (Wet) @0.3ESP (Lo)	170	145	175	170	200	180	220	200	275	290	290	275	275	315	295
Indoor CFM (Dry) @0.3ESP (Hi)	235	210	240	235	265	250	250	265	335	320	350	335	350	390	370
Indoor CFM (Dry) @0.3ESP (Lo)	195	170	200	195	225	210	210	225	295	280	310	295	310	350	330
<b>Electric Heat Data</b>															
Heater Size (kW)															
208V	*	1.6	2.9	*	*	1.6	2.9	4.1	*	1.6	2.9	4.1	1.6	2.9	4.1
230V	*	2.0	3.5	*	*	2.0	3.5	5.0	*	2.0	3.5	5.0	2.0	3.5	5.0
265V	*	2.0	3.7	*	*	2.0	3.7	5.0	*	2.0	3.7	5.0	2.0	3.7	5.0
Btu/Hr															
208V	*	5,500	9,900	*	*	5,500	9,900	14,000	*	5,500	9,900	14,000	5,500	9,900	14,000
230V	*	6,800	11,900	*	*	6,800	11,900	17,100	*	6,800	11,900	17,100	6,800	11,900	17,100
265V	*	6,800	11,900	*	*	6,800	11,900	17,100	*	6,800	11,900	17,100	6,800	11,900	17,100
Heating Watt															
208V	*	1,640	2,935	*	*	1,640	2,935	4,140	*	1,640	2,940	4,140	1,640	2,945	4,140
230V	*	2,045	3,540	*	*	2,045	3,540	5,045	*	2,045	3,545	5,045	2,045	3,550	5,045
265V	*	2,040	3,740	*	*	2,040	3,740	5,040	*	2,040	3,740	5,040	2,040	3,740	5,040
Heating Amps															
208V	*	7.7	13.9	*	*	7.7	13.9	19.7	*	7.7	13.9	19.7	7.7	13.9	19.7
230V	*	8.7	15.2	*	*	8.7	15.2	21.7	*	8.7	15.2	21.7	8.7	15.2	21.7
265V	*	7.6	14.0	*	*	7.6	14.0	18.9	*	7.6	14.0	18.9	7.6	14.0	18.9

Certified in accordance with the Unitary Air-Conditioner Equipment Certification Program, which is based on ARI Standard 310/380.



# Specifications

## Heat Pump Performance Data

	PTHD 07			PTHD 09			PTHD 12			PTHD 15		
Voltage (V)	208	230	265	208	230	265	208	230	265	208	230	265
<b>Cooling Data</b>												
Cooling Capacity (Btu/h)	7,300	7,600	7,600	9,000	9,300	9,300	11,700	12,000	12,000	14,000	14,100	14,100
Cooling Amps (A)	3.0	2.8	2.4	4.1	3.8	3.2	5.6	5.1	4.4	6.5	7.1	5.7
Cooling Power (W)	600	625	625	805	830	830	1095	1120	1120	1445	1455	1470
EER (Btu/h/Watt)	12.2	12.2	12.2	11.2	11.2	11.2	10.7	10.7	10.7	9.7	9.7	9.6
Moisture Removal (Pts/h)	2.0	2.0	2.0	2.6	2.6	2.6	3.6	3.6	3.6	4.5	4.5	4.5
<b>Heat Pump Heating Data</b>												
Heating Capacity (Btu/h)	6,200	6,400	6,400	8,200	8,400	8,400	10,900	11,200	11,200	13,300	13,500	13,500
Heating Amps (A)	2.6	2.4	2.4	3.4	3.1	2.6	3.4	3.1	3.4	6.0	5.5	4.8
Heating Power (W)	520	535	535	670	685	685	940	965	965	1210	1235	1235
COP (W/W)	3.5	3.5	3.5	3.6	3.6	3.6	3.4	3.4	3.4	3.2	3.2	3.2
<b>Airflow</b>												
Indoor CFM (Wet) @0.3ESP (Hi)	195	225	225	240	270	270	310	340	340	315	355	355
Indoor CFM (Wet) @0.3ESP (Lo)	155	185	185	190	230	230	270	300	300	275	315	315
Indoor CFM (Dry) @0.3ESP (Hi)	220	250	250	260	290	290	330	360	360	350	390	390
Indoor CFM (Dry) @0.3ESP (Lo)	180	210	210	220	250	250	290	330	320	310	350	350
<b>Electric Heat Data</b>												
<b>Heater Size (kW)</b>												
208V	1.6	2.9	*	1.6	2.9	4.1	1.6	2.9	4.1	1.6	2.9	4.1
230V	2.0	3.5	*	2.0	3.5	5.0	2.0	3.5	5.0	2.0	3.5	5.0
265V	2.0	3.7	*	2.0	3.7	5.0	2.0	3.7	5.0	2.0	3.7	5.0
<b>Btu/Hr</b>												
208V	5,500	9,900	*	5,500	9,900	14,000	5,500	9,900	14,000	5,500	9,900	14,000
230V	6,800	11,900	*	6,800	11,900	17,100	6,800	11,900	17,100	6,800	11,900	17,100
265V	6,800	11,900	*	6,800	11,900	17,100	6,800	11,900	17,100	6,800	11,900	17,100
<b>Heating Watt</b>												
208V	1,640	2,935	*	1,640	2,935	4,140	1,640	2,940	4,140	1,640	2,945	4,140
230V	2,045	3,540	*	2,045	3,540	5,045	2,045	3,545	5,045	2,045	3,550	5,045
265V	2,040	3,740	*	2,040	3,740	5,040	2,040	3,740	5,040	2,040	3,740	5,040
<b>Heating Amps</b>												
208V	7.7	13.9	19.7	7.7	13.9	19.7	7.7	13.9	19.7	7.7	13.9	19.7
230V	8.7	15.2	21.7	8.7	15.2	21.7	8.7	15.2	21.7	8.7	15.2	21.7
265V	7.6	14.0	18.9	7.6	14.0	18.9	7.6	14.0	18.9	7.6	14.0	18.9

Certified in accordance with the Unitary Air-Conditioner Equipment Certification Program, which is based on ARI Standard 310/380.

# Performance Charts

## Cooling Wattage - Air Conditioners

Model	PTED0701	PTED0702	PTED0901	PTED0902	PTED1201	PTED1202	PTED1501	PTED1502	
Temperature									
Outdoor Air Dry Bulb	Return Air Wet Bulb	Total Wattage Input		Total Wattage Input		Total Wattage Input		Total Wattage Input	
		Min	Max	Min	Max	Min	Max	Min	Max
Rating Wattage		560	625	785	810	1045	1090	1045	1090
100	85	590	715	815	900	1050	1180	1080	1190
	80	585	720	820	905	1055	1180	1090	1205
	75	585	720	820	905	1060	1180	1100	1215
	70	585	720	820	905	1055	1180	1100	1220
	65	590	715	815	900	1050	1180	1095	1215
	60	580	710	805	890	1045	1175	1090	1205
	55	570	700	795	880	1030	1160	1070	1190
95	85	560	685	770	855	1000	1125	1025	1140
	80	565	690	775	860	1005	1130	1035	1150
	75	565	695	780	865	1005	1135	1035	1160
	70	565	690	775	860	1005	1130	1045	1165
	65	560	690	770	855	1000	1125	1040	1160
	60	555	680	765	850	990	1120	1030	1150
	55	540	670	765	835	980	1105	1020	1135
90	85	540	660	730	815	950	1070	965	1085
	80	540	665	735	820	950	1075	980	1095
	75	540	665	735	820	955	1080	990	1105
	70	540	665	735	820	950	1075	990	1105
	65	535	660	730	815	950	1070	990	1100
	60	525	660	720	805	940	1060	980	1095
	55	520	640	710	795	930	1055	965	1075
85	85	510	635	690	770	895	1020	915	1025
	80	515	640	690	775	900	1020	930	1040
	75	520	640	695	780	905	1030	936	1046
	70	515	640	690	775	900	1020	935	1050
	65	510	635	690	770	895	1020	930	1045
	60	505	625	680	765	890	1010	925	1035
	55	490	615	670	755	880	1000	907	1020
80	85	485	605	645	730	850	970	860	970
	80	490	610	650	735	850	970	870	985
	75	490	610	650	735	850	975	880	990
	70	490	610	650	735	850	970	885	990
	65	485	605	645	730	850	970	880	990
	60	475	600	635	720	940	960	870	980
	55	465	585	625	710	830	950	855	965



# Performance Charts

## Cooling Wattage - Heat Pumps

Model	PTHD0701	PTHD0702	PTHD0901	PTHD0902	PTHD1201	PTHD1202	PTHD1501	PTHD1502	
Temperature									
Outdoor Air Dry Bulb	Return Air Wet Bulb	Total Wattage Input		Total Wattage Input		Total Wattage Input		Total Wattage Input	
		Min	Max	Min	Max	Min	Max	Min	Max
Rating Wattage		600	625	810	850	1120	1145	1430	1460
100	85	625	705	830	935	1120	1230	1445	1570
	80	620	710	835	940	1125	1235	1465	1590
	75	620	710	835	940	1130	1240	1475	1600
	70	620	710	835	940	1125	1240	1475	1600
	65	615	705	830	935	1120	1230	1470	1600
	60	605	695	820	925	1115	1230	1460	1580
	55	595	685	810	915	1100	1210	1440	1562
95	85	580	670	785	890	1070	1180	1375	1500
	80	585	675	790	890	1075	1190	1390	1520
	75	590	680	795	890	1075	1190	1410	1530
	70	585	675	790	890	1075	1190	1410	1530
	65	580	670	785	890	1070	1180	1400	1520
	60	575	675	780	880	1060	1170	1390	1515
	55	560	655	770	865	1050	1160	1370	1495
90	85	550	640	745	845	1020	1130	1305	1430
	80	555	645	750	850	1025	1135	1325	1445
	75	555	645	750	850	1025	1135	1335	1460
	70	555	645	750	850	1025	1125	1340	1460
	65	550	640	745	845	1020	1130	1335	1455
	60	540	630	735	835	1010	1120	1320	1440
	55	530	620	720	825	1000	1110	1260	1420
85	85	515	610	700	800	970	1080	1240	1360
	80	520	610	705	800	975	1085	1260	1380
	75	525	615	705	810	975	1085	1265	1390
	70	520	610	705	800	975	1085	1265	1395
	65	515	610	700	800	970	1080	1260	1390
	60	510	600	690	790	960	1070	1250	1375
	55	500	590	680	775	950	1060	1230	1355
80	85	485	575	655	755	920	1030	1170	1290
	80	490	580	660	760	925	1030	1185	1310
	75	490	480	660	760	925	1035	1195	1320
	70	490	580	660	760	920	1030	1200	1320
	65	485	575	655	755	920	1030	1195	1315
	60	475	565	650	745	910	1020	1180	1305
	55	465	555	635	735	900	1010	1160	1280

# Performance Charts

## Cooling Change of Temperature - Air Conditioners

		Model							
Room Air Dry Bulb	Room Air Wet Bulb	PTED0701	PTED0702	PTED0901	PTED0902	PTED1201	PTED1202	PTED1501	PTED1502
		Temperature Across Indoor Coil (Δ T)		Temperature Across Indoor Coil (Δ T)		Temperature Across Indoor Coil (Δ T)		Temperature Across Indoor Coil (Δ T)	
		Min	Max	Min	Max	Min	Max	Min	Max
Rating Btu/h		7000	7600	9000	9300	11700	12000	14300	14600
Rating CFM		185	225	230	260	300	330	315	355
90	85	1	3	2	6	1	5	1	4
	80	8	13	11	14	9	13	8	12
	75	19	22	19	22	18	22	16	20
	70	30	33	28	30	26	30	25	27
85	80	4	9	7	11	5	10	5	8
	75	14	19	15	18	13	18	12	16
	70	23	27	23	25	21	25	20	23
	65	34	36	31	33	29	33	28	30
80	75	9	14	11	14	9	13	8	12
	70	18	21	18	20	15	20	15	18
	65	26	29	24	27	23	26	21	24
	60	35	36	32	33	29	33	29	30
75	70	12	16	13	16	10	15	10	14
	65	18	22	18	21	15	20	15	19
	60	25	28	23	26	21	25	20	24
	55	31	34	28	31	26	30	26	28
70	65	12	15	12	14	9	13	9	13
	60	17	20	16	18	13	17	13	17
	55	22	24	20	22	18	21	17	21

## Cooling Change of Temperature - Heat Pumps

		Model							
Room Air Dry Bulb	Room Air Wet Bulb	PTHD0701	PTHD0702	PTHD0901	PTHD0902	PTHD1201	PTHD1202	PTHD1501	PTHD1502
		Temperature Across Indoor Coil (Δ T)		Temperature Across Indoor Coil (Δ T)		Temperature Across Indoor Coil (Δ T)		Temperature Across Indoor Coil (Δ T)	
		Min	Max	Min	Max	Min	Max	Min	Max
Rating Btu/h		7300	7600	9300	9600	12300	12600	14300	14600
Rating CFM		195	225	240	270	310	340	315	355
90	85	1	3	2	6	1	5	1	4
	80	8	13	11	15	10	13	8	12
	75	19	22	19	22	18	22	17	20
	70	30	33	29	30	26	30	25	28
85	80	4	9	7	11	5	10	5	9
	75	14	19	15	18	14	18	12	16
	70	23	27	23	25	21	25	21	23
	65	33	36	31	33	30	33	28	31
80	75	9	14	11	15	10	13	8	12
	70	18	21	18	20	16	20	16	18
	65	26	29	24	27	23	26	22	25
	60	35	36	32	33	30	33	29	31
75	70	12	16	13	16	11	15	10	14
	65	18	22	18	21	16	20	16	19
	60	24	28	23	26	21	25	21	24
	55	31	34	29	31	26	30	26	29
70	65	12	15	12	15	10	13	9	13
	60	17	20	16	18	14	17	13	17
	55	22	24	20	22	18	21	18	21



# Performance Charts

## Cooling Ampere Chart - Air Conditioners

Cond Inlet Air Temperature	Model		Model		Model		Model		Model		Model		Model		Model	
	PTED0701		PTED0702		PTED0901		PTED0902		PTED1201		PTED1202		PTED1501		PTED1502	
	Amperage		Amperage		Amperage		Amperage		Amperage		Amperage		Amperage		Amperage	
	Min	Max	Min	Max	Min	Max	Min	Max	Min	Max	Min	Max	Min	Max	Min	Max
Rating Ampere	2.6	2.9	2.4	2.4	3.6	3.9	3.2	3.2	4.8	5.2	4.2	4.2	6.5	7.1	5.7	5.7
100	2.6	2.9	2.4	2.6	3.4	4.0	2.9	3.1	5.6	5.6	3.9	4.3	6.6	8.0	5.6	6.2
95	2.4	2.8	2.3	2.5	3.2	3.8	2.7	3.0	5.4	5.3	3.7	4.1	6.2	7.6	5.3	5.9
90	2.3	2.7	2.2	2.4	3.1	3.6	2.6	2.9	5.2	5.1	3.6	3.9	5.9	7.2	5.1	5.6
85	2.2	2.6	2.1	2.3	2.9	3.4	2.5	2.7	4.9	4.8	3.4	3.8	5.6	6.8	4.8	5.3
80	2.1	2.4	2.0	2.2	2.8	3.3	2.3	2.6	4.7	4.6	3.2	3.6	5.3	6.4	4.6	5.1

## Cooling Ampere Chart - Heat Pumps

Cond Inlet Air Temperature	Model		Model		Model		Model		Model		Model		Model		Model	
	PTHD0701		PTHD0702		PTHD0901		PTHD0902		PTHD1201		PTHD1202		PTHD1501		PTHD1502	
	Amperage		Amperage		Amperage		Amperage		Amperage		Amperage		Amperage		Amperage	
	Min	Max	Min	Max	Min	Max	Min	Max	Min	Max	Min	Max	Min	Max	Min	Max
Rating Ampere	2.6	2.9	2.4	2.4	3.6	3.9	3.2	3.2	4.8	5.2	4.2	4.2	6.5	7.1	5.7	5.7
100	2.6	2.9	2.5	2.7	3.4	4.0	3.0	3.2	5.6	5.5	4.1	4.5	6.6	8.0	5.5	6.1
95	2.4	2.8	2.4	2.6	3.2	3.8	2.8	3.1	5.3	5.2	3.9	4.3	6.2	7.6	5.2	5.8
90	2.3	2.6	2.2	2.5	3.1	3.6	2.7	3.0	5.0	5.0	3.7	4.1	5.9	7.2	5.0	5.5
85	2.1	2.5	2.1	2.3	3.1	3.4	2.6	2.9	4.8	4.7	3.5	3.9	5.6	6.8	4.7	5.2
80	2.1	2.3	2.1	2.2	2.9	3.3	2.5	2.7	4.6	4.5	3.3	3.7	5.3	6.4	4.5	4.9

## Heating Wattage - Heat Pumps

Temperature	Model																	
	Outside		PTHD0701		PTHD0702		PTHD0901		PTHD0902		PTHD1201		PTHD1202		PTHD1501		PTHD1502	
	Air Dry Bulb	Room Air Dry Bulb	Total Wattage Input		Total Wattage Input		Total Wattage Input		Total Wattage Input		Total Wattage Input		Total Wattage Input					
		Min	Max	Min	Max	Min	Max	Min	Max	Min	Max	Min	Max	Min	Max	Min	Max	
		Rating Wattage	520	535	670	685	940	965	1210	1235								
50	85	580	620	745	790	1030	1115	1295	1435									
	80	565	600	725	775	1010	1095	1275	1410									
	75	550	590	710	760	990	1075	1245	1385									
	70	535	575	695	740	970	1050	1225	1360									
	65	520	560	675	720	945	1025	1200	1335									
45	85	565	600	710	760	1000	1080	1240	1375									
	80	550	590	695	740	975	1060	1214	1355									
	75	630	570	680	730	955	1040	1190	1330									
	70	515	555	660	710	930	1010	1160	1305									
	65	500	540	640	690	910	995	1145	1280									
40	85	545	580	680	725	950	1040	1185	1320									
	80	530	570	660	710	940	1020	1160	1300									
	75	515	555	640	690	920	1000	1135	1270									
	70	500	535	630	675	895	980	1110	1250									
	65	480	520	610	675	875	955	1090	1220									
35	85	525	565	650	695	925	1010	1130	1270									
	80	510	550	630	675	900	985	1110	1240									
	75	500	535	610	655	880	965	1080	1220									
	70	480	520	600	645	855	940	1060	1190									
	65	465	500	580	625	840	922	1030	1265									

# Performance Charts

## Heating Change of Temperature - Heat Pumps

		Model							
Room Air Dry Bulb	Room Air Wet Bulb	PTHD0701	PTHD0702	PTHD0901	PTHD0902	PTHD1201	PTHD1202	PTHD1501	PTHD1502
		Temperature Across Indoor Coil (Δ T)		Temperature Across Indoor Coil (Δ T)		Temperature Across Indoor Coil (Δ T)		Temperature Across Indoor Coil (Δ T)	
		Min	Max	Min	Max	Min	Max	Min	Max
Rating Btu/h		6200	6400	8200	8400	10900	11200	13300	13500
Rating CFM		220	250	260	290	330	360	350	390
50	85	22	24	24	27	27	30	28	30
	80	23	24	25	28	28	31	29	31
	75	24	25	26	29	29	32	30	31
	70	26	27	28	30	31	34	32	33
	65	26	27	28	30	31	34	32	33
45	85	19	22	22	24	24	29	27	30
	80	20	23	23	25	25	29	28	31
	75	21	24	24	26	26	30	29	31
	70	22	24	24	27	27	31	30	32
	65	23	25	25	28	28	32	31	33
40	85	17	20	20	22	23	27	27	30
	80	18	21	21	23	23	28	28	31
	75	19	22	22	24	24	29	29	31
	70	20	23	23	24	25	29	30	32
	65	21	24	24	25	26	30	31	33
35	85	15	17	17	20	21	24	27	29
	80	16	18	18	21	22	25	28	30
	75	17	19	19	22	23	26	29	31
	70	18	20	20	23	23	27	30	31
	65	19	21	21	24	24	28	31	32

## Heat Pump Reverse Cycle Heating Capacity

Model	PTHD07			PTHD09			PTHD12			PTHD15			
Voltage	208	230	265	208	230	265	208	230	265	208	230	265	
Amps	2.6	2.4	2.4	3.4	3.1	2.6	4.7	4.3	3.8	6.0	5.5	4.8	
Watts	520	535	535	670	685	685	940	965	965	1210	1235	1235	
Btuh	6200	6400	6400	8200	8400	8400	10900	11200	11200	13300	13500	13500	
COP	3.5	3.5	3.5	3.6	3.6	3.6	3.4	3.4	3.8	3.2	3.2	3.2	
CFM (Dry)	195	225	225	240	270	270	310	340	340	315	355	355	
Heating Btuh													
Outdoor Ambient	62	7200	7400	7400	9800	10100	10100	13200	13500	13500	15800	16000	16000
	57	6900	7100	7100	9300	9600	9600	12500	12800	12800	15000	15200	15200
Rating Point	52	6500	6700	6700	8700	9000	9000	11700	12000	12000	14200	14400	14400
	47	6200	6400	6400	8200	8400	8400	10900	11200	11200	13300	13500	13500
Rating Point	42	5900	6100	6100	7700	7900	7900	10200	10500	10500	12500	12700	12700
	37	5600	5800	5800	7200	7400	7400	9500	9700	9700	11700	11900	11900
	32	5300	5500	5500	6700	6900	6900	9600	8900	8900	10800	11000	11000
	27	5000	5200	5200	6200	6300	6300	7900	8200	8200	10000	10200	10200
	24	4800	5000	5000	5800	6000	6000	7500	7800	7800	9500	9700	9700
	Watts												
Outdoor Ambient	62	555	565	565	725	740	740	1034	1060	1060	1300	1325	1325
	57	550	560	560	715	730	730	1010	1030	1030	1275	1305	1305
Rating Point	52	530	540	540	695	710	710	980	1000	1000	1245	1270	1270
	47	525	535	535	670	685	685	945	965	965	1210	1235	1235
Rating Point	42	505	525	525	650	665	665	910	930	930	1175	1200	1200
	37	500	510	510	630	645	645	880	900	900	1140	1165	1165
	32	490	500	500	615	630	630	830	850	850	1100	1120	1120
	27	480	495	495	585	600	600	790	810	810	1055	1080	1080
	24	475	490	490	570	585	585	765	785	785	1045	1070	1070

# Schematic Diagrams (PTHD/PTED)

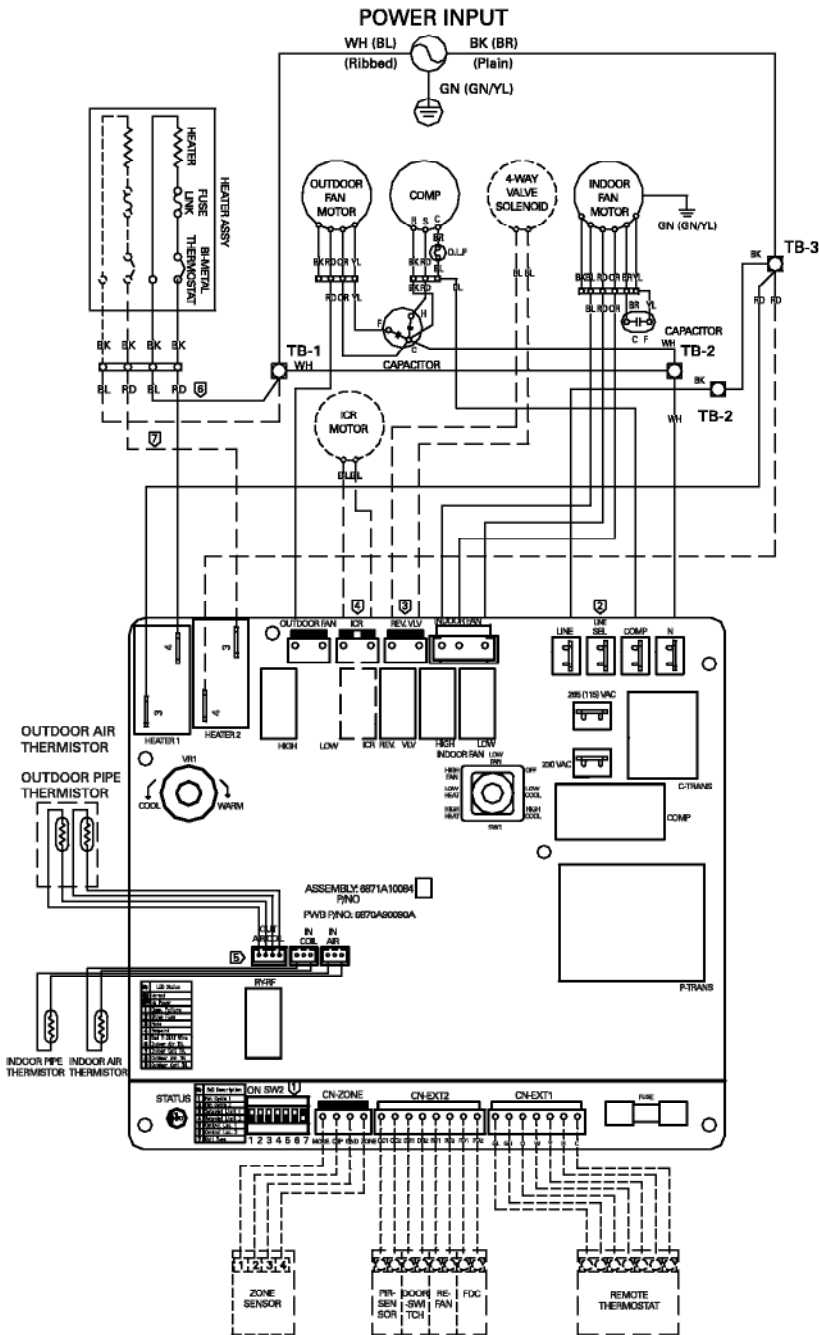

- 1 For PTED model, Set Switch Position As Fig1  
For PTHD Model, Set Switch Position As Fig 2
- 2 Must Be Connected For 230V As Fig 3  
Must Be Connected For 265V As Fig 4
- 3 On Heat Pump Model Only
- 4 On Heat Pump Model Only (Option)
- 5 Remove For Non Heat Pump Applications
- 6 For 3.5 KW Heat Applications
- 7 For 5.0KW Heat Applications



<Fig 1>

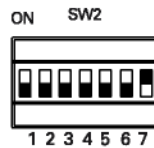

<Fig 2>

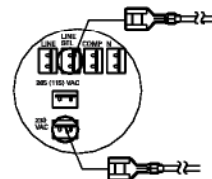

<Fig 3>

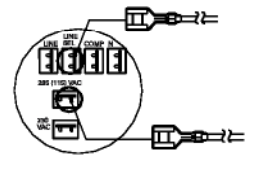

<Fig 4>

# Schematic Diagrams (Hydronic)

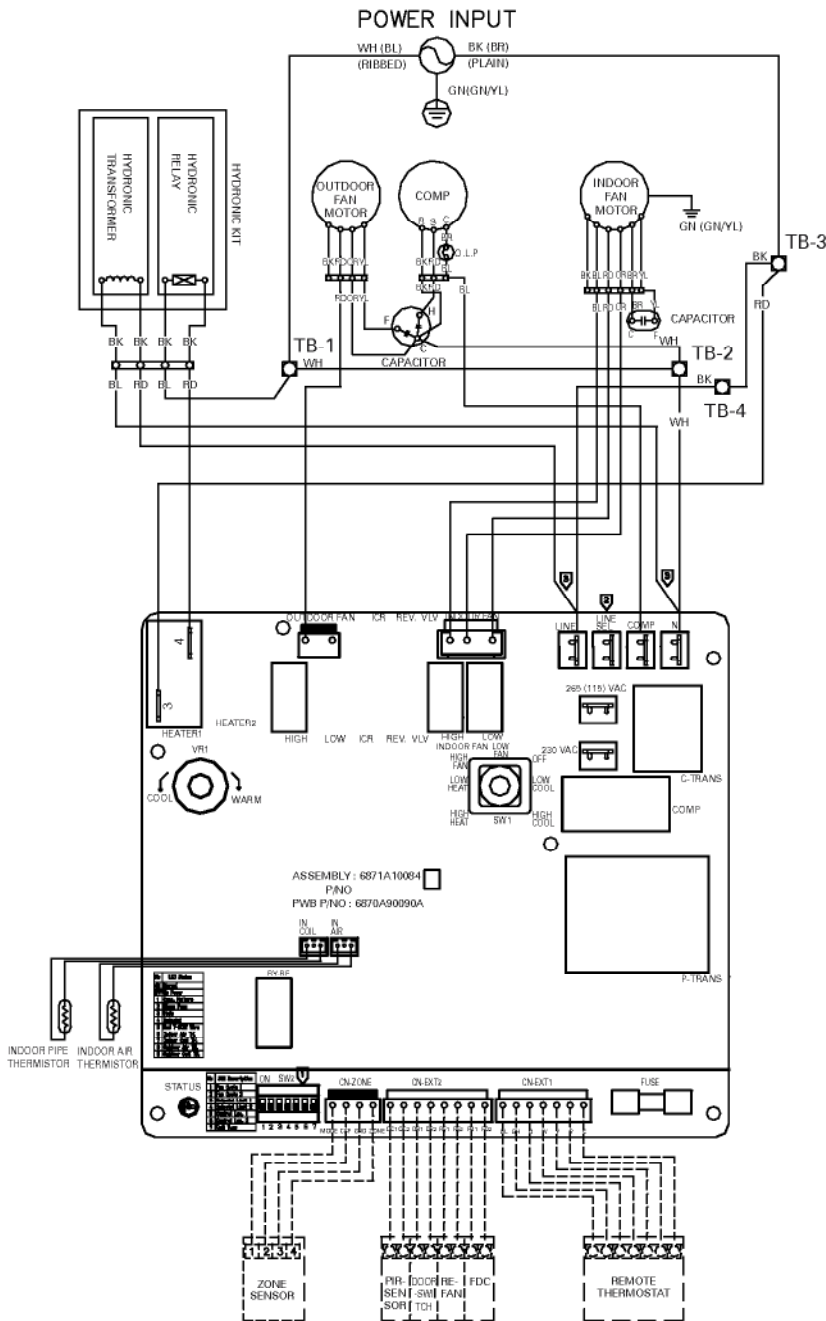

- 1 For PTED model, Set Switch Position As Fig1
- 2 Must Be Connected For 208V/230V As Fig 2
- Must Be Connected For 265V As Fig 3
- Must Be Connected For 115V As Fig 4
- 3 Connect the piggy-back wirings

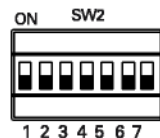

<Fig 1>

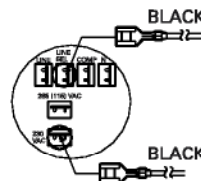

<Fig 2>

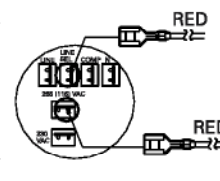

<Fig 3>

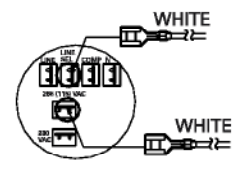

<Fig 4>

# Schematic Diagrams

## Trane Zone Sensor Wiring

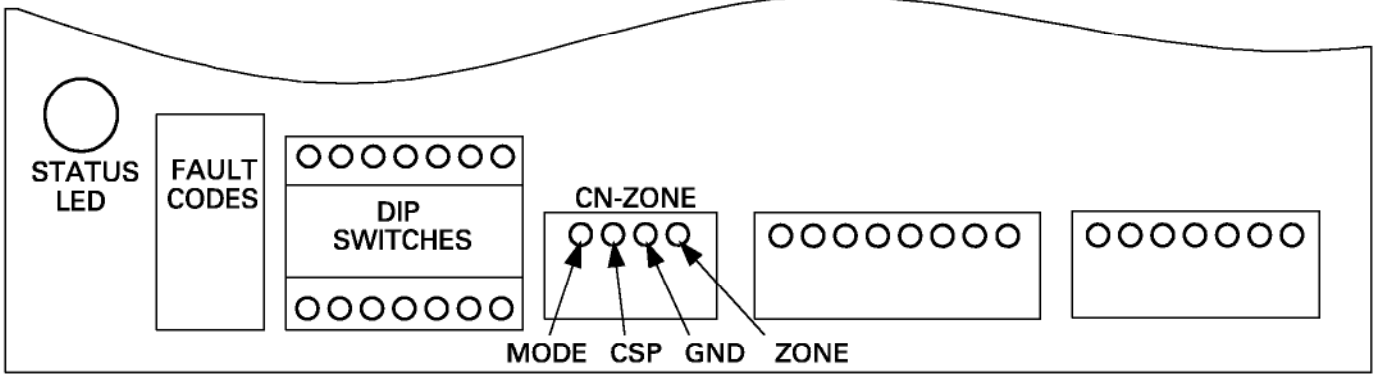

**Note:** Refer to the Remote Operation Section for DIP switch settings and Zone Sensor Features.

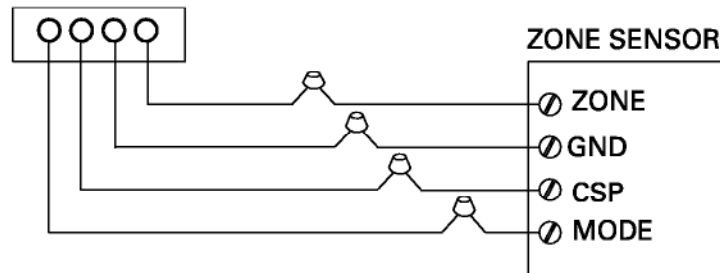

## Energy Management System

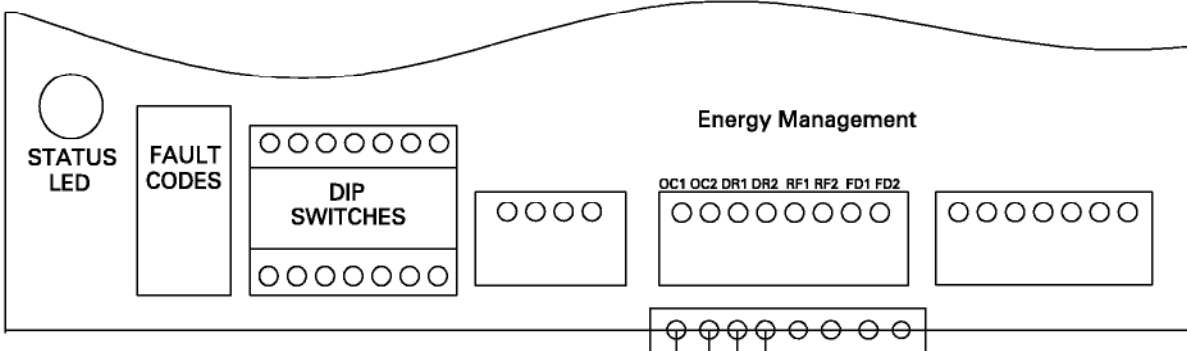

**Note:** The Occupancy Sensor and Door Switch are not provided by Trane. They are to be field-installed and supplied. Refer to Product Support Online or call the Zone Products Business Unit for more information on Occupancy Sensors and Door Switches.

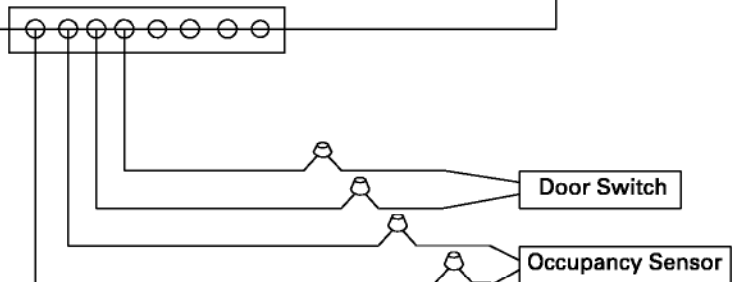

# Schematic Diagrams

## Front Desk Switch and Remote Fan Wiring

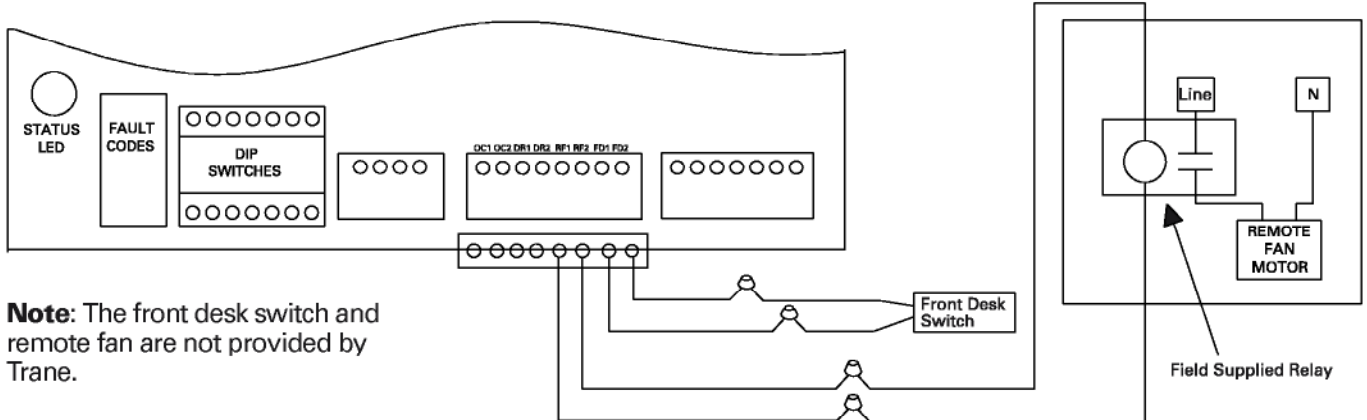

**Note:** The front desk switch and remote fan are not provided by Trane.

## Remote Thermostat Wiring

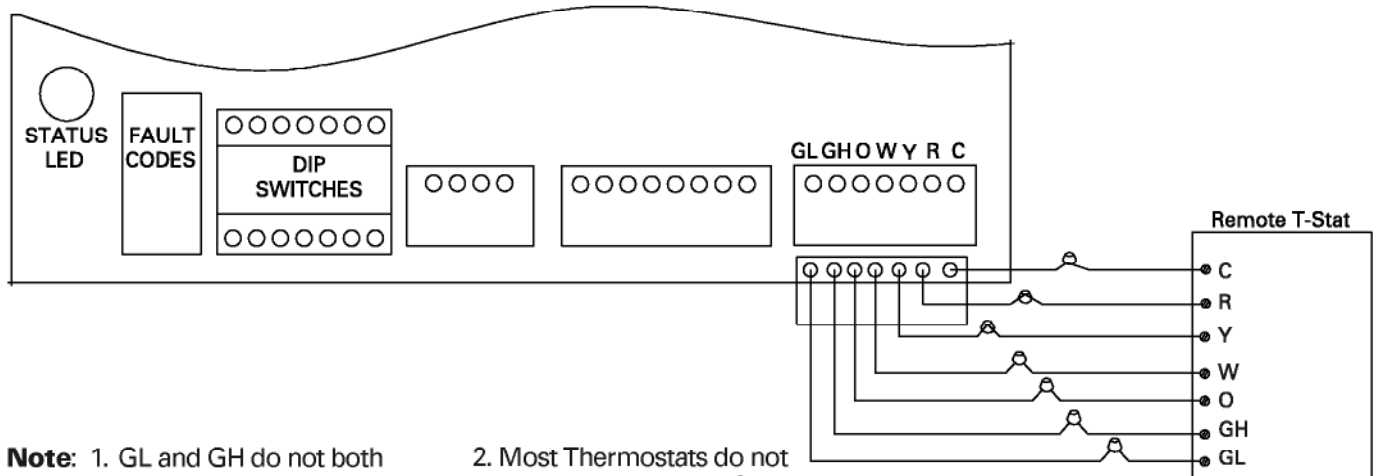

**Note:** 1. GL and GH do not both need to be wired to the thermostat. If the thermostat only offers one G (Fan) connection, then either GL (Low Fan) or GH (High Fan) must be used.

2. Most Thermostats do not require a common (C) connection. If your thermostat does not have a common connection, it doesn't need to be wired.



**TRANE**

*Trane*  
**An American Standard Company**  
[www.trane.com](http://www.trane.com)

For more information contact  
your local district office or  
e-mail us at [comfort@trane.com](mailto:comfort@trane.com)



Literature Order Number	PTAC-SVX01A-EN
File Number	SV-XN-PTAC-000-SVX01A-0902-EN
Supersedes	PTAC-SVN01A-EN and PTAC-SVU01A-EN
Stocking Location	La Crosse

*Trane has a policy of continuous product and product data improvement and reserves the right to change design and specifications without notice. Only qualified technicians should perform the installation and servicing of equipment referred to in this publication.*