



website <http://www.lgservice.com>
e-mail <http://www.lgservice.com/techsup.html>

LG

LG Water Cooled Package Air Conditioner

INSTALLATION MANUAL

**MODELS: AKWW0243AA0 AKWW0243YA0
AKWW0183AA0 AKWW0183YA0
AKWW0123AA0 AKWW0123YA0
AKWW0093AA0 AKWW0093YA0**

ENGLISH

FRANÇAIS

ESPAÑOL

IMPORTANT

- Please read this instruction sheet completely before installing the product.
- When the power cord is damaged, replacement work shall be performed by authorized personnel only.
- Installation work must be performed in accordance with the national wiring standards by authorized personnel only.
- Please retain this owner's manual for future reference after reading it thoroughly.

TABLE OF CONTENTS

<i>Installation Requirements</i>	<i>Required Parts</i>	<i>Required Tools</i>
Safety Precautions3	<input type="checkbox"/> Panel, Return	<input type="checkbox"/> Screw driver
	<input type="checkbox"/> Grille, Discharge	<input type="checkbox"/> Electric drill
Introduction8	<input type="checkbox"/> Hose, Flexible(1/2")	<input type="checkbox"/> Specified torque wrenches
Symbols Used in this Manual8	<input type="checkbox"/> Remote controller	<input type="checkbox"/> Spanner
Features8		<input type="checkbox"/> Ohmmeter
		<input type="checkbox"/> Ammeter
Installation10		<input type="checkbox"/> Thermometer
Installation Parts10		<input type="checkbox"/> Horizontal meter
Installation Tools10		<input type="checkbox"/> Pipe wrench
Weights / Clearance11		
Installation13		
Pre-Start-up Checklist17		
Maintenance18		

WATER-SOURCE HEAT PUMP INSTALLATION INSTRUCTIONS

IMPORTANT!

Please read this instruction sheet completely before installing the product.

This air conditioning system meets strict safety and operating standards. As the installer or service person, it is an important part of your job to install or service the system so it operates safely and efficiently.

WARNING

- Installation or repairs made by unqualified persons can result in hazards to you and others. Installation **MUST** conform with local building codes or, in the absence of local codes, with the National Electrical Code NFPA 70/ANSI C1-1993 or current edition and Canadian Electrical Code Part1 CSA C.22.1.
- The information contained in the manual is intended for use by a qualified service technician familiar with safety procedures and equipped with the proper tools and test instruments.
- Failure to carefully read and follow all instructions in this manual can result in equipment malfunction, property damage, personal injury and/or death.

CAUTION: Improper installation, adjustment, alteration, service or maintenance can void the warranty. The weight of the condensing unit requires caution and proper handling procedures when lifting or moving to avoid personal injury. Use care to avoid contact with sharp or pointed edges.

Safety Precautions

- Always wear safety eye wear and work gloves when installing equipment.
- Never assume electrical power is disconnected. Check with meter and equipment.
- Keep hands out of fan areas when power is connected to equipment.
- R-410A causes frostbite burns.
- R-410A is toxic when burned.

NOTE TO INSTALLING DEALER: The Owners Instructions and Warranty are to be given to the owner or prominently displayed near the indoor Furnace/Air Handler Unit.

WARNING

When wiring:

Electrical shock can cause severe personal injury or death. Only a qualified, experienced electrician should attempt to wire this system.

- Do not supply power to the unit until all wiring and tubing are completed or reconnected and checked.
- Highly dangerous electrical voltages are used in this system. Carefully refer to the wiring diagram and these instructions when wiring. Improper connections and inadequate grounding can cause accidental injury or death.
- Ground the unit following local electrical codes.
- Connect all wiring tightly. Loose wiring may cause overheating at connection points and a possible fire hazard.

When transporting:

Be careful when picking up and moving the units. Get a partner to help, and bend your knees when lifting to reduce strain on your back. Sharp edges or thin aluminum fins on the air conditioner can cut your finger. Move the product more than two people, Improper moving may result in injury.

When servicing

- Turn the power OFF at the main power box(mains) before opening the unit to check or repair electrical parts and wiring.
- Keep your fingers and clothing away from any moving parts.
- Clean up the site after you finish, remembering to check that no metal scraps or bits of wiring have been left inside the unit being serviced.

Safety Precautions



To prevent injury to the user or other people and property damage, the following instructions must be followed.

- Be sure to read before installing the air conditioner.
- Be sure to observe the cautions specified here as they include important items related to safety.
- Incorrect operation due to ignoring instruction will cause harm or damage. The seriousness is classified by the following indications.

⚠ WARNING This symbol indicates the possibility of death or serious injury.

⚠ CAUTION This symbol indicates the possibility of injury or damage to properties only.

- Meanings of symbols used in this manual are as shown below.

	Be sure not to do.
	Be sure to follow the instruction.

⚠ WARNING

■ Installation

Do not place the power cord near a heater.

- It may cause fire and electric shock.
(See features section)

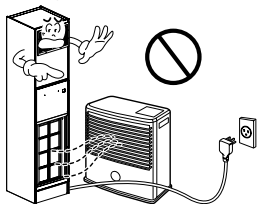

Do not use the power cord near flammable gas or combustibles such as gasoline, benzene, thinner, etc.

- It may cause explosion or fire.

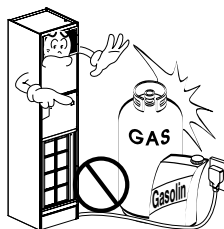

Do not disassemble or modify products.

- It may cause failure and electric shock.
(See features section)

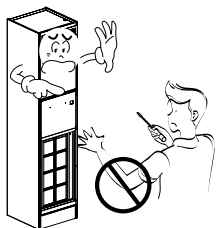

■ Operation

Plug in the power plug properly.

- Otherwise, it will cause electric shock or fire due to heat generation or electric shock.

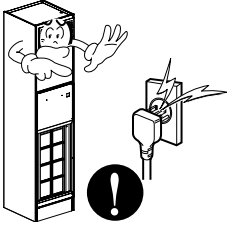

Do not operate or stop the unit by inserting or pulling out the power plug.

- It will cause electric shock or fire due to heat generation.



Do not damage or use an unspecified power cord.

- It will cause electric shock or fire.

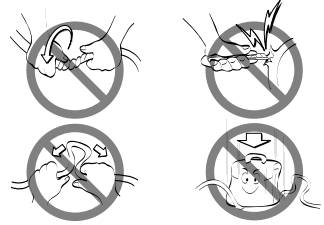

Do not modify power cord length.

- It will cause electric shock or fire due to heat generation.

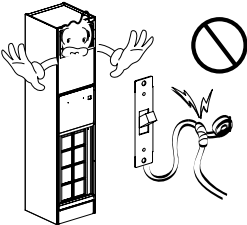

Always plug into a grounded outlet.

- No grounding may cause electric shock (See Installation Manual).

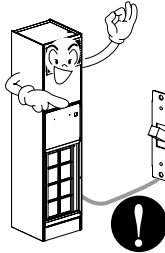

Unplug the unit if strange sounds, odors, or smoke come from it.

- Otherwise it may cause fire and electric shock accident.

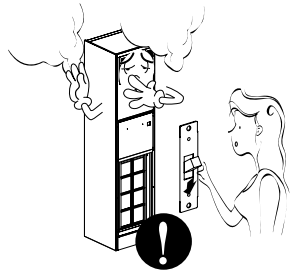

Do not operate with wet hands or in damp environment.

- It will cause electric shock.

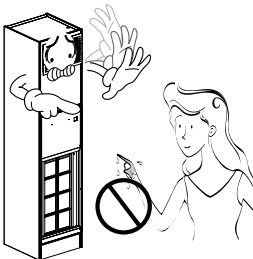

Do not allow water to run into electric parts.

- It will cause failure of machine or electric shock.

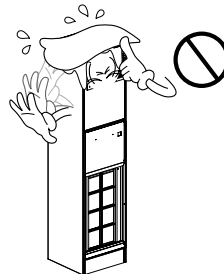

Leave the door closed while the air conditioner is running.

- It is not designed to cool the entire house.

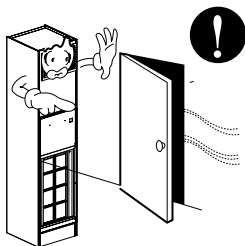

Ventilate before operating air conditioner when gas goes out.

- It may cause explosion, fire, and burn.



CAUTION

Installation

Never touch the metal parts of the unit when removing the filter.

- They are sharp and may cause injury.

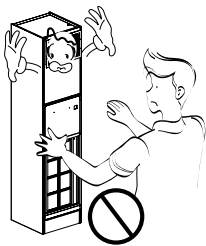

Do not block the inlet or outlet.

- It may cause failure of appliance or accident.

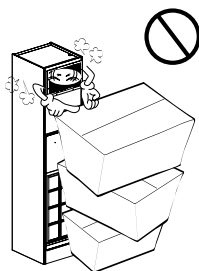

Be cautious not to touch the sharp edges when installing.

- It may cause injury.

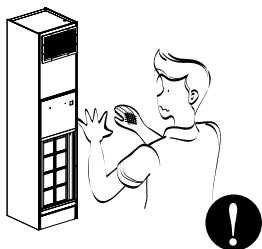

Turn off the main power switch when not using it for a long time.

- Prevent accidental startup and the possibility of injury.

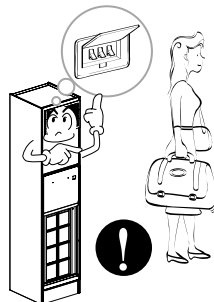

Do not place heavy object on the power cord and take care so that the cord should not be pressed.

- There is danger of fire or electric shock.

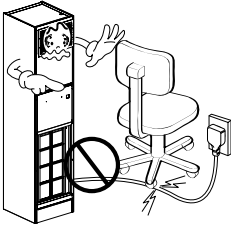

If water enters the product, turn off the the power switch of the main body of appliance. Contact service center after taking the power-plug out from the socket.

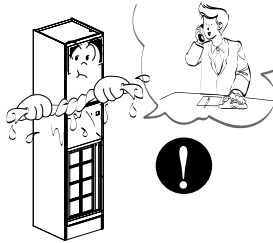

Do not clean the air conditioner with water.

- Water may enter the unit and degrade the insulation. It may cause an electric shock.

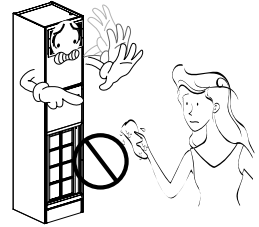

Turn off the power and breaker firstly when cleansing the unit.

- Since the fan rotates at high speed during operation, it may cause injury.



Do not put a pet or house plant where it will be exposed to direct air flow.

- This could injure the pet or plant.

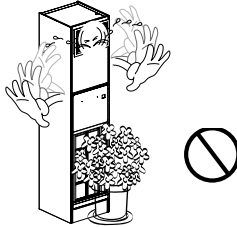

Do not use this appliance for special purposes such as pets, foods, precision machinery, or objects of art.

- It is an air conditioner, not a precision refrigeration system.

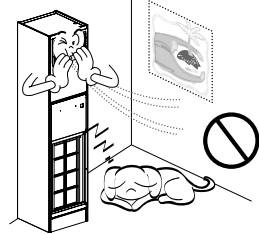

Always insert the filter securely. Clean it every two weeks.

- Operation without filters will cause failure.

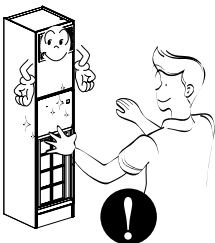

Use a soft cloth to clean. Do not use wax, thinner, or a strong detergent.

- The appearance of the air conditioner may deteriorate, change color, or develop surface flaws.

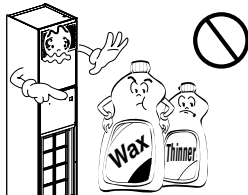

Do not drink water drained from air conditioner. / Do not direct airflow at room occupants only.

- It contains containments and will make you sick. / This could damage your health.

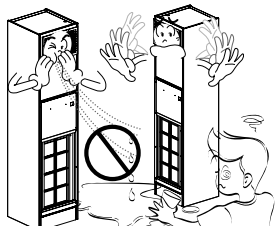

Introduction

Symbols Used in this Manual



This symbol alerts you to the risk of electric shock.



This symbol alerts you to hazards that could cause harm to the air conditioner.

NOTICE

This symbol indicates special notes.

Features

AKWW0243AA0 AKWW0243YA0

AKWW0183AA0 AKWW0183YA0

AKWW0123AA0 AKWW0123YA0

AKWW0093AA0 AKWW0093YA0

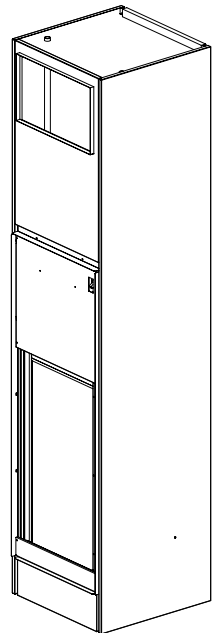
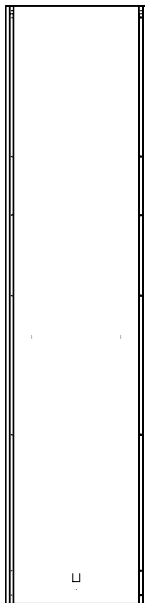
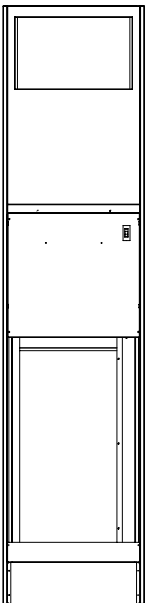
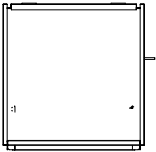



CAUTION

Be cautious not to touch the sharp edges when installing. It may cause injury.

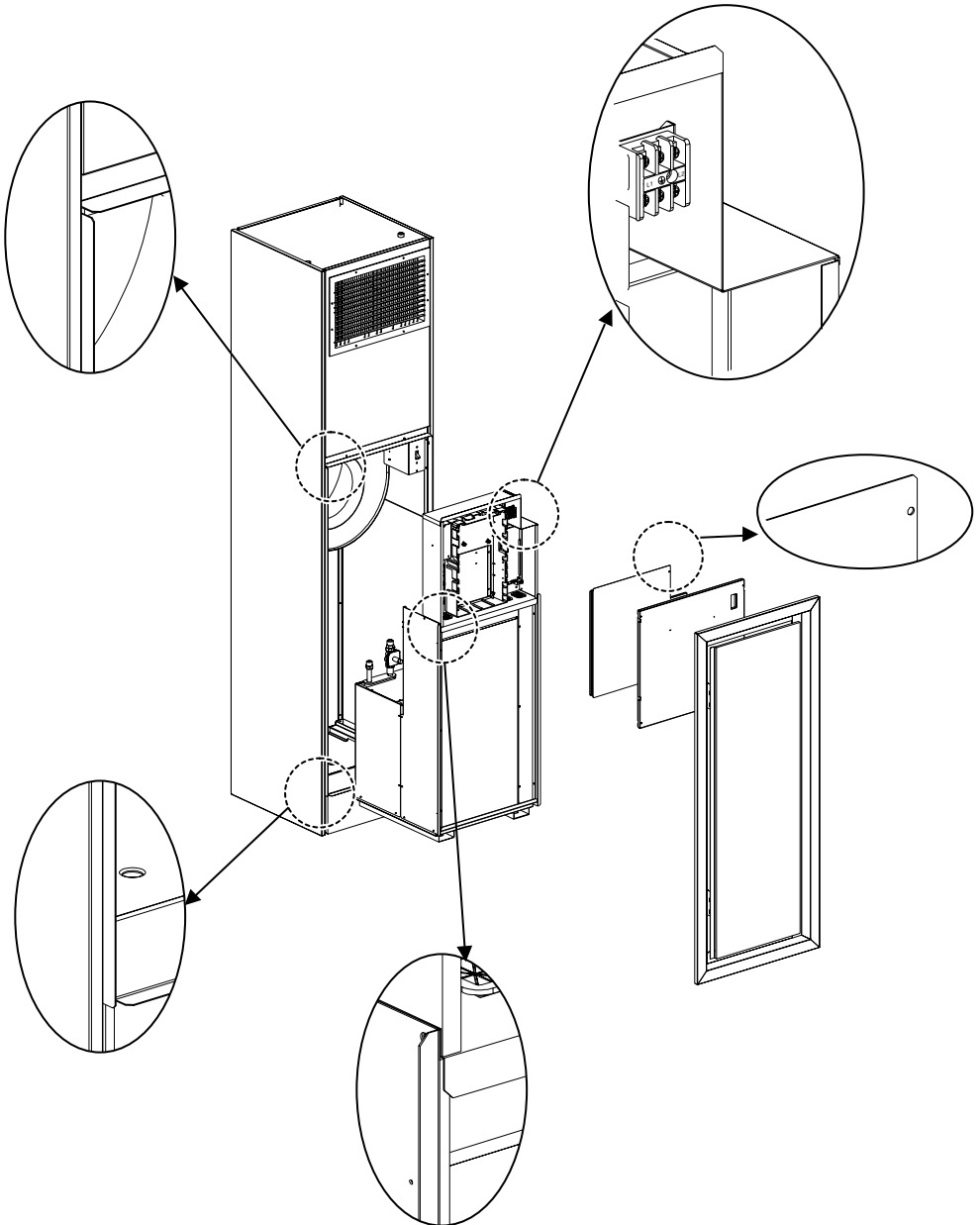

ENGLISH

AKWW0243AA0 / AKWW0183AA0 / AKWW0123AA0 / AKWW0093AA0

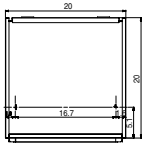

(Unit:inch)

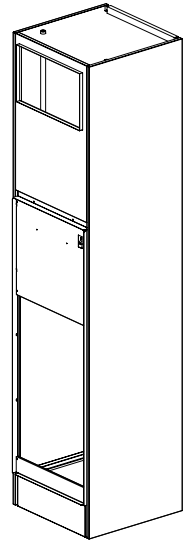
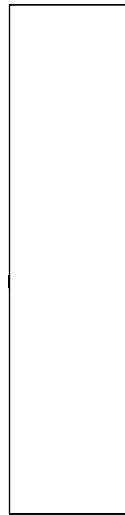
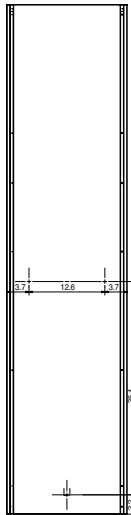
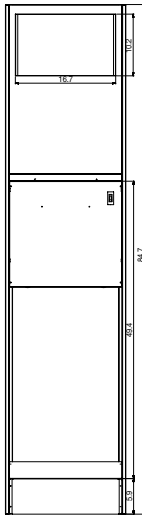

AKWW0243YA0 / AKWW0183YA0 / AKWW0123YA0 / AKWW0093YA0

(Unit:inch)

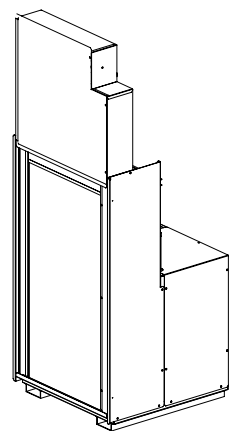
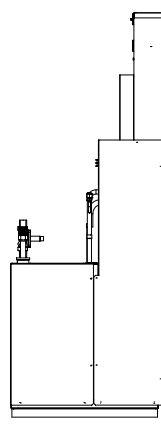
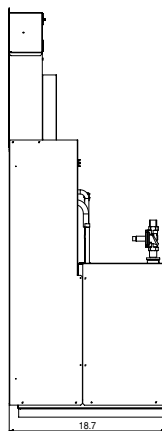
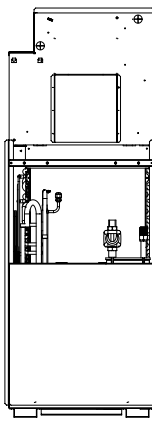
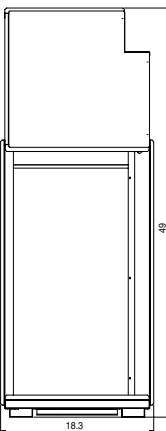
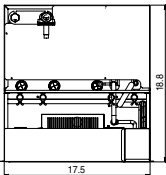

Installation

Read completely, then follow step by step.

Installation Parts(Optional)

<p style="text-align: center;">Panel, Return(1EA)</p> <p>※ Recommended to use part supplied by LG (Unit: inch)</p>	<p style="text-align: center;">Grille, Discharge(1EA)</p> <p>※ Recommended to use part supplied by LG (Unit: inch)</p>
<p style="text-align: center;">Hose, Flexible(2EA)</p> <p style="text-align: center;">※ Not supplied by LG</p>	<p style="text-align: center;">Remote controller (1set)</p> <p>※ Recommended to use part supplied by LG</p>

Installation Tools

Figure	Name	Figure	Name
	Screw driver		Ohmmeter
	Electric drill		Ammeter
	Spanner		Thermometer, Horizontal meter
	Torque wrench		
	Tefron Tape		

Weights / Clearance

- Improper Unit Lift

Test lift unit approximately 24 inches to verify proper center of gravity lift point. To avoid dropping of unit, reposition lifting point if unit is not level. Failure to properly lift unit could result in death or serious injury or possible equipment or property-only damage.

Model Name(Cabinet)	Shipping Weight(lb/kg)	Unit Weight(lb/kg)
AKWW0243AA0	171/78	139/63
AKWW0183AA0	171/78	139/63
AKWW0123AA0	171/78	139/63
AKWW0093AA0	171/78	139/63

Model Name(Chassis)	Shipping Weight(lb/kg)	Unit Weight(lb/kg)
AKWW0243YA0	161/73	135/61
AKWW0183YA0	161/73	135/61
AKWW0123YA0	161/73	135/61
AKWW0093YA0	161/73	135/61

- Unit Location and Clearances

Locate the unit in an indoor area. The ambient temperature surrounding the unit must not be less than 45°F. Do not locate the unit in areas subject to freezing.

Attention should be given to service clearance and technician safety.

The unit chassis should be easily removed from the cabinet in all applications.

There must be enough space for service personnel to perform maintenance or repair.

Provide sufficient room to make water, and electrical connection(s).

Local and national codes should be followed in providing electrical power connections.

See below figure for mechanical clearances.

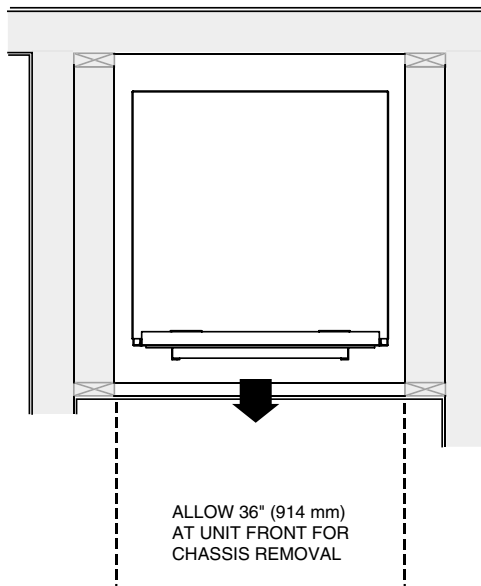

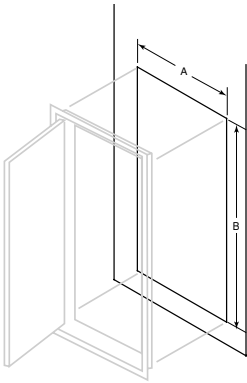

SHEET ROCK
OPENING

Unit: inch(mm)

A	B
21.3(542)	52.9(1344)
21.3(542)	52.9(1344)
21.3(542)	52.9(1344)
21.3(542)	52.9(1344)

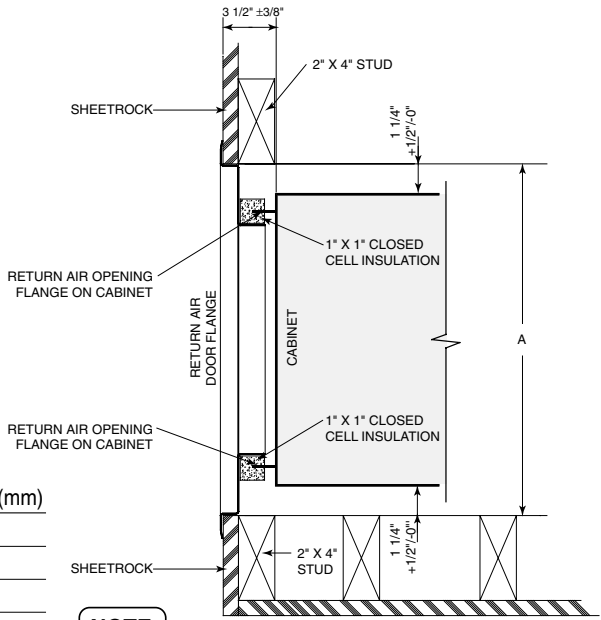

NOTE

Finished wall and framing should not touch the unit cabinetry.

TOP VIEW

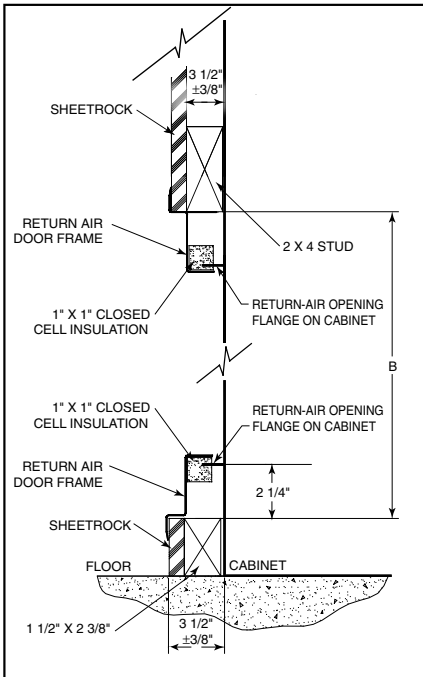

SIDE VIEW

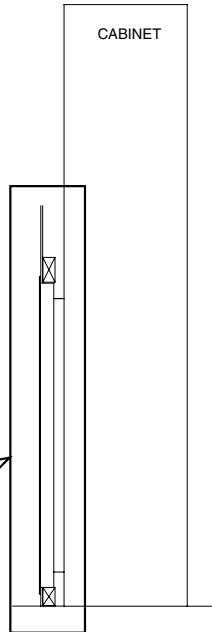

Unit Placement

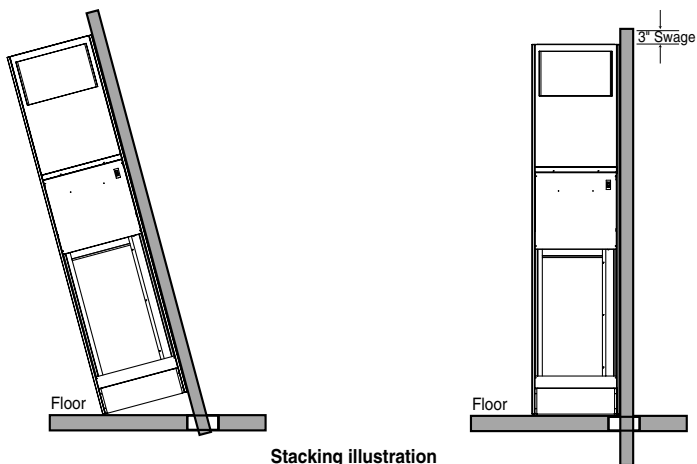

Stacking illustration

Unit placement

If unit cabinet assembly includes factory provided risers, and "no" field provided between-the-floor riser extensions, please move to Step 1.

Note: Risers are designed to accommodate a maximum of 1 1/2" to 3" expansion and contraction. If the total calculated riser expansion exceeds 3", expansion devices must be field provided.

If unit cabinet assembly includes factory provided risers and field provided between-the floor riser extensions are required, install the extensions before installing the cabinet.

1. Install drain valve, shut-off balancing valves, flow indicators and drain at the base of each supply and return riser to enable system flushing at start-up, balancing and service maintenance.
2. Lift cabinet into space while aligning it into the 3" swage of the riser below.

Note: Take extra care as not to scrape or dent risers during positioning. The riser should fall approximately 2" into the 3" swage. This will allow for the variation in floor-to-floor dimensions, and keep the riser joints from bottoming out.

3. Level the cabinet
4. Plum bribers in two planes to as sure proper unit operation and condensate drainage.
5. Anchor all units into place.
6. For field provided risers, center the supply/return stubou is into the unit expansion slots. The stubou is ahold be perpendicular to the cabinet panel.
7. Verify all risers are vertical and that they penetrate the swaged joint at least 1". Riser should not be allowed to bottom out.
8. Braze riser joints. Sot solder or low-temperature alloys should not be used in this application.
9. If risers are field provided, it is recommended that the risers be anchored to the building structure with a minimum of one contact point. For expansion and contraction reasons, do not fasten risers rigidly to the building.
10. Seal access holes made through the cabinet for piping with suitable material to help eliminate air leakage.

Water Connection

For vibration isolation, it is recommended that flexible steel braided hoses be installed instead of hard piping between the vertical risers and the unit chassis.

Cleaning and Flushing the Water Loop

Supply Grille installation

1. Install the supply grille(s) into the cabinet discharge opening. Insure there are no air gaps between the cabinet supply air and the grille. This helps prevent recirculation of supply air into the return air opening behind the drywall.
2. Secure grille(s) into the drywall via two screws.

Cleaning and flushing the Water Loop

After the piping system is complete, the flexible hose connector should be doubled back to complete the water circuit external to the unit (avoiding trash settle-ut in the condenser). An extra pipe may be necessary to connect the hose kits. See page 15 for antifreeze/water mixture by volume.

3. Water circulation system should be filled with clean water using the water make up connections.

Note: Air vents should be opened during filling.

4. With the air vents closed, start the circulating pump and then crack the air vents to bled off the trapped air, assuring circulation through all components of the system.

Note: Make up water must be available to the system to replace the volume formerly occupied by the air that is bled off.

5. With the air vented and the water circulating, the entire system should be checked for leaks with repairs made as required.
6. Operate the supplementary heat system making checks per manufacturer's instructions. During this operation, visual checks should be made for leaks that may have occurred due to increased heat. Repair as required.
7. Open the system at the lowest point for the initial blow down (making sure the make up water is equal to the water being dumped). Continue blow down until the water leaving the drain runs clear, but not less than 2 hours.
8. Shut down pumps and supplementary heat system. Reconnect the hoses placing the water-to-refrigerant heat exchanger in the water circulating system.

Note: Vents should be open when the pumps and supplementary heat system are shut down.

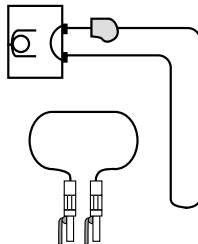

Flushing the water loop

Connect the cable

Connect the cable to the unit by connecting the wires to the terminals on the control board individually according to the unit connection.

The earth wire should be longer than the common wires.

The circuit diagram is not subject to change without notice.

When installing, refer to the wiring diagram behind the panel front of Unit.



CAUTION:

- The diagram is not subject to change without notice.
- Be sure to connect wires according to the wiring diagram.
- Connect the wires firmly, so that not to be pulled out easily.
- Connect the wires according to color codes by referring the wiring diagram.



CAUTION: The power cord connected to the unit should be complied with the following specifications.

Model	Min.Thickness (inch ²)		Circuit breaker (NFB)	Leak current circuit breaker (ELB)
	Main/Earth	AWG		
AKWW0243YA0	0.005/0.005	12	25A	25A 100mA 0.1sec ↓
AKWW0183YA0	0.005/0.005	12	20A	20A 100mA 0.1sec ↓
AKWW0123YA0	0.003/0.003	14	15A	15A 100mA 0.1sec ↓
AKWW0093YA0	0.003/0.003	14	15A	15A 100mA 0.1sec ↓



RECOMMEND: Provide a circuit breaker between power source and the unit as shown below.

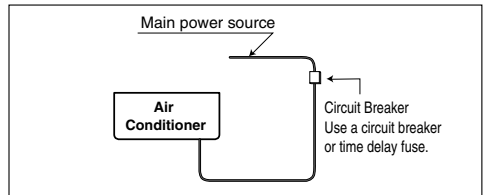

RECOMMEND: The power cord connected to the unit should be complied with the following specifications (ETL recognized and CSA certified).

AKWW0123YA0
AKWW0093YA0

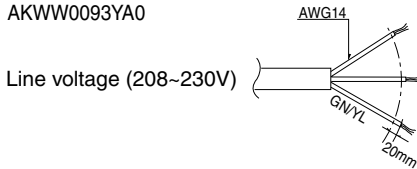

Line voltage (208~230V)

AKWW0183YA0
AKWW0243YA0

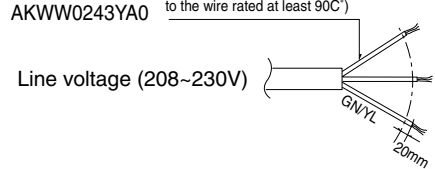

Line voltage (208~230V)

AWG12 (Allowable temperature to the wire rated at least 90C)

The power connecting cable connected to the indoor and outdoor unit should be complied with the following specifications (ETL recognized and CSA certified).

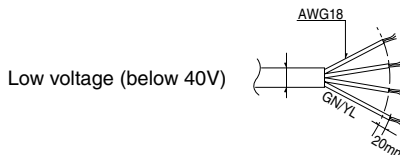

Low voltage (below 40V)



RECOMMEND: When using the separate wire as the power cord, please fix the separate wire into the control box panel by using tie wrap as the fixture.

How to connect the Power cable

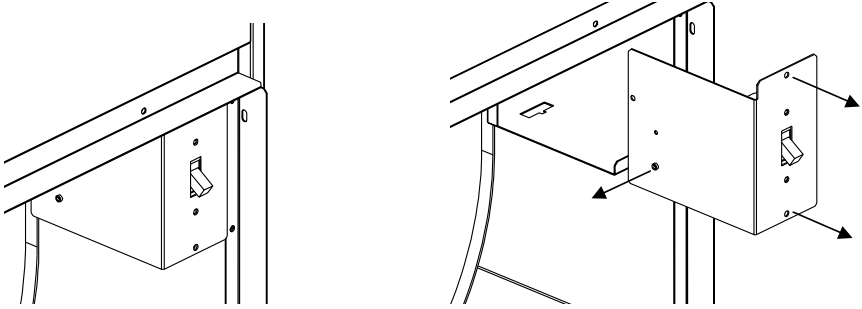

Remove the case of Manual controllers switch

1. Connect the power cable to the right side of manual controllers switch via clamp cord
2. Put the earth with grounding screw
3. Connect the lead wire from manual controllers switch to terminal block in control box refer to the wiring diagram

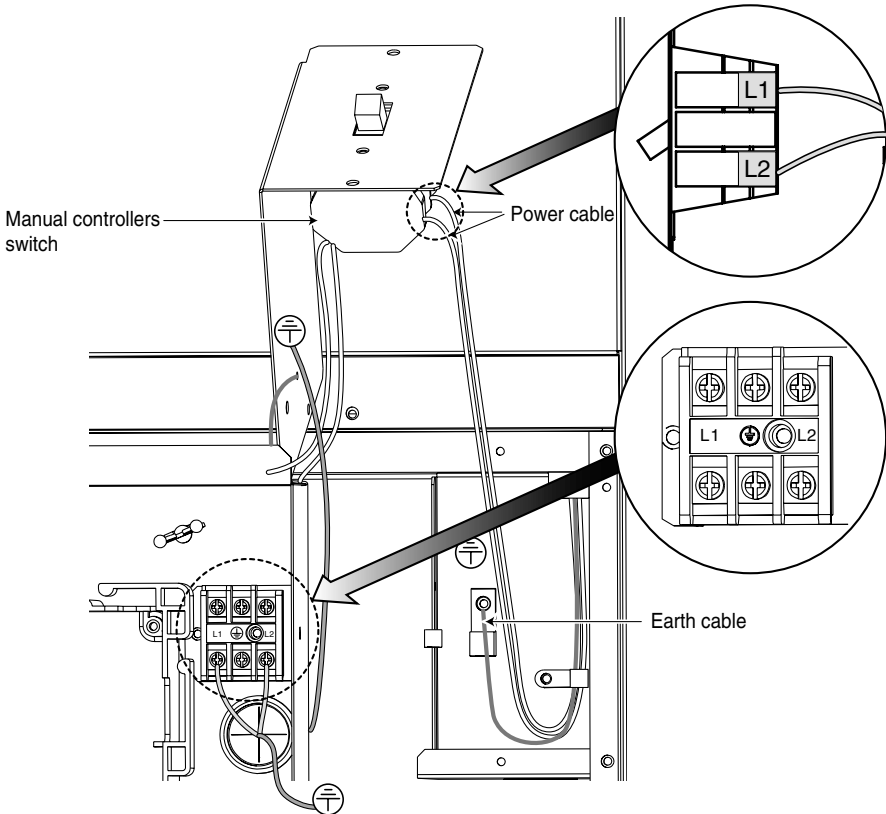

Connection method of the connecting cable(Example)



WARNING: Loose wiring may cause the terminal to overheat or result in unit malfunction. A fire hazard may also exist. Therefore, be sure all wiring is tightly connected.

When connecting each power wire to the corresponding terminal, follow instructions "How to connect wiring to the terminals" and fasten the wire tightly with the fixing screw of the terminal plate.

How to connect wiring to the terminals and the manual controllers switch

For strand wiring

- (1) Cut the wire end with a wire cutter or wire-cutting pliers, then strip the insulation to expose the strand wiring about 10mm(3/8").
- (2) Using a screwdriver, remove the terminal screw(s) on the terminal (manual controllers switch) plate.
- (3) Using a round terminal fastener or pliers, securely clamp each stripped wire end with a round terminal.
- (4) Position the round terminal wire, and replace and tighten the terminal screw using a screwdriver.

High voltage

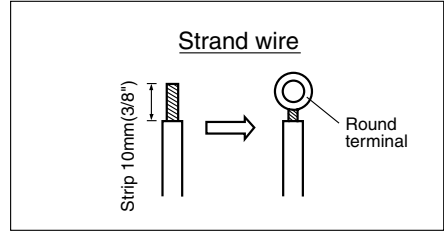

Low voltage

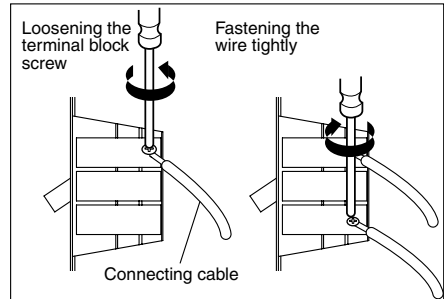
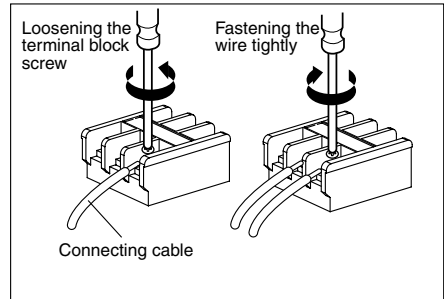

How to connect the drain hose

To check the drainage.

1. Pour a glass of water on the evaporator.
2. Ensure the water flows through the drain hose of the unit without any leakage and goes out the drain exit.

When extending the drain hose at the unit, install the drain pipe.

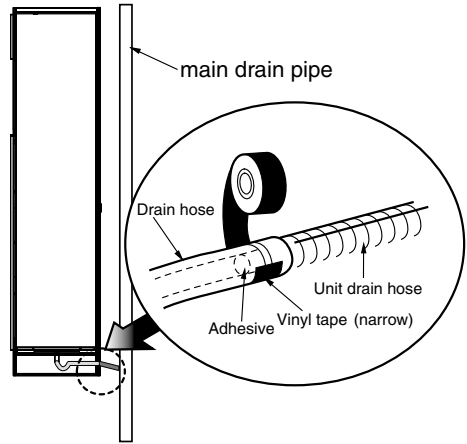

Drain piping

1. The drain hose should point downward for easy drain flow.

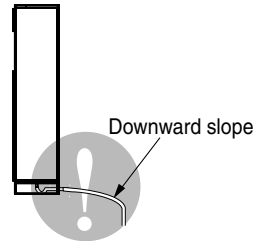

2. Do not make drain piping.

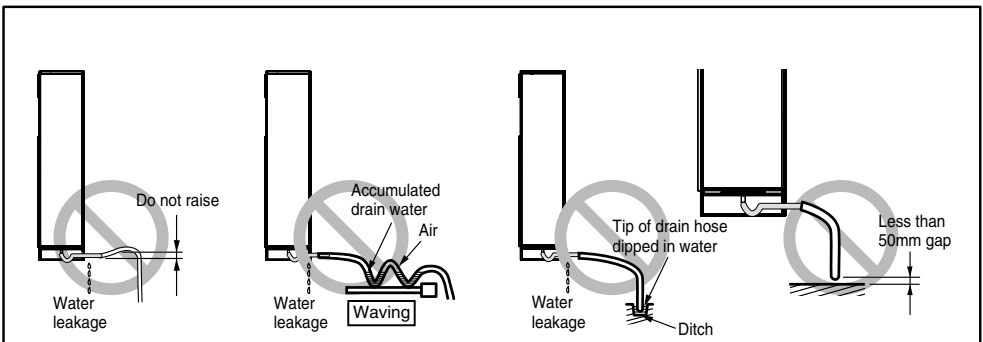

How to connect the water hose

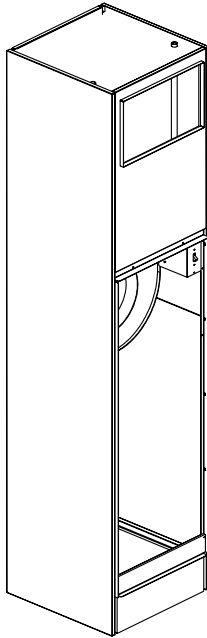

Remove the cover of front panel

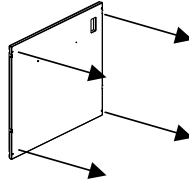

Connect supply and return water hoses refer to the label index

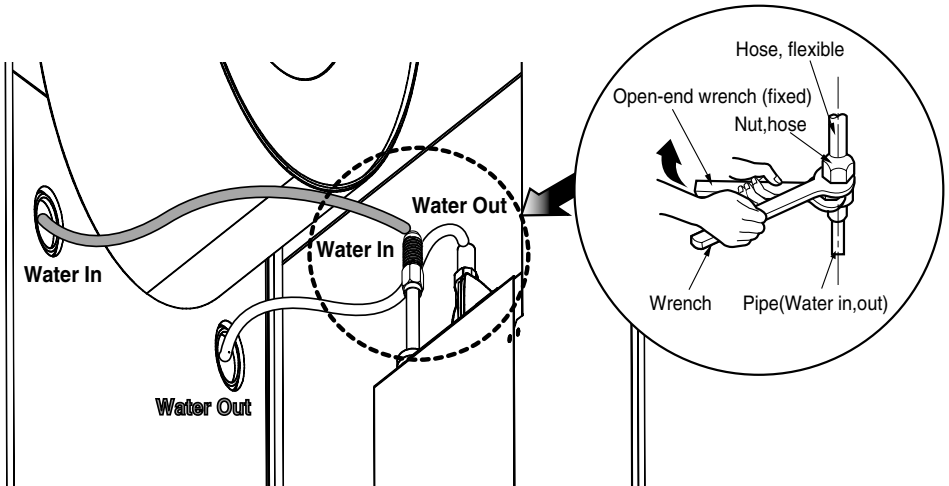

How to connect the remote controller lead wire

1. Remove the cover of front panel
2. Remove the cover of control box

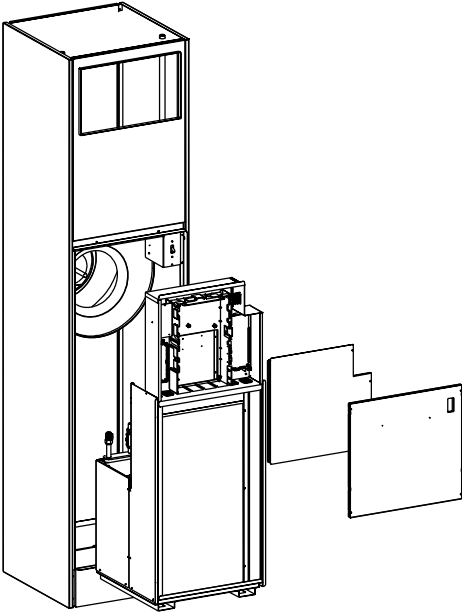

3. Connect remote controller lead wire to the indoor PCB via hole on the control box refer to the Wiring diagram

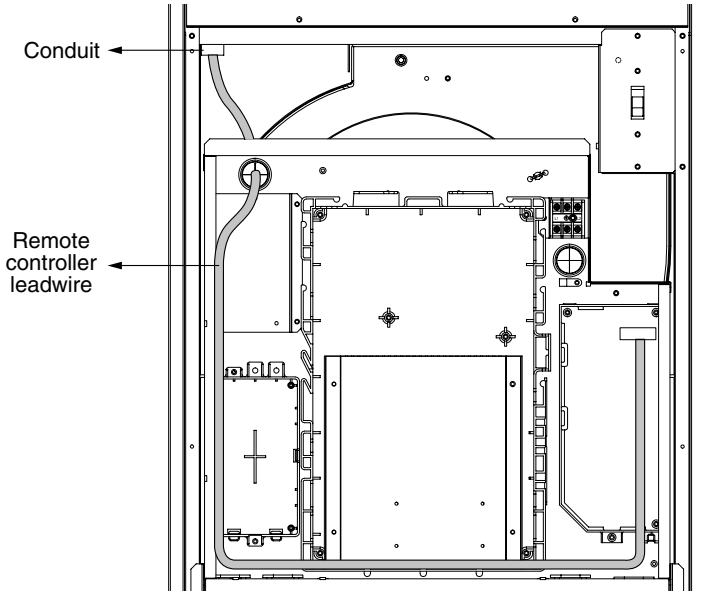

Remote Controller Installation method

1 Put the installation paper on the place and determine the position and height of the fixing screws of the wired remote controller.

- Refer to the printed side of the installation paper.

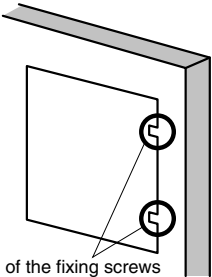

The position of the fixing screws

2 Plug the connecting cable into the indoor unit.

- The product is being shipped with the cable connected only to the remote controller.

Fix the connecting cable with the cable rack.

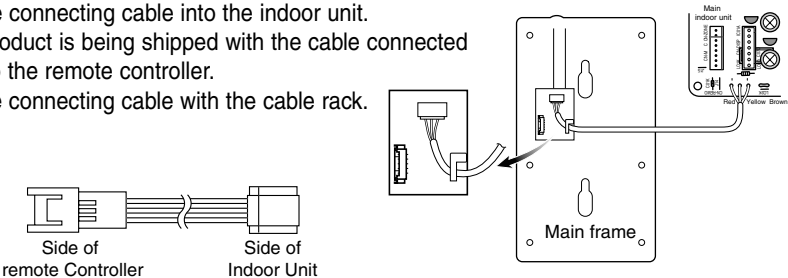

Side of remote Controller Side of Indoor Unit

Main frame

Main indoor unit

3 Remove the installation paper before installing the remote controller so that it can fit at the right place.

Fixing the remote controller

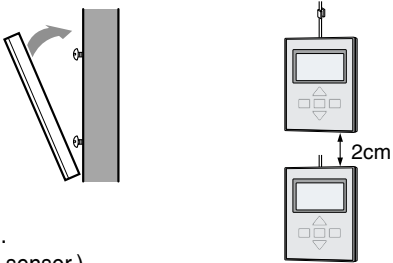

2cm

- * Do not embed the remote controller into the wall. (It may cause the breakdown of the temperature sensor.)
- * If you want to install a number of remote controller at the same place in a vertical line, install them at regular intervals of 2cm. (It may cause the breakdown of the temperature sensor.)
- * Do not install the cable with a distance of 50 m or longer. (This can cause communication error.)
- * When installing the cable, check whether the connector between the remote controller and the product is installed properly. The connector will not be connected when installed in opposite sides.

Supply the power after connecting wired remote controller.

When you need to change wired remote controller, switch off the main power and change it. If the wired remote controller is changed before switching off the main power, the option function of the indoor unit can't be used. (option function like "slo" fan speed selection)

How to install the chassis to the cabinet

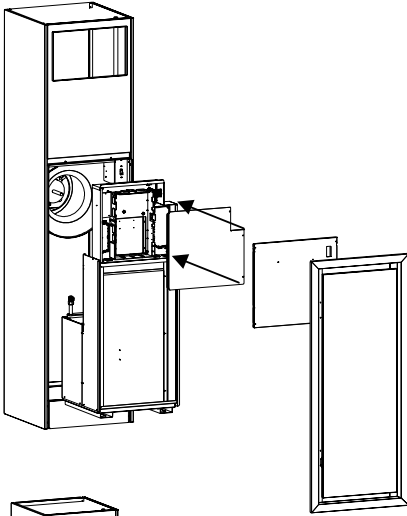

1. Assemble the cover of control box

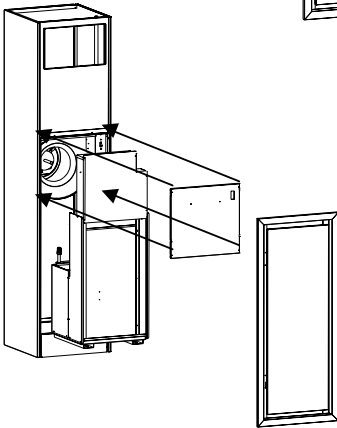

2. Assemble the chassis to the cabinet by sliding

3. Assemble the cover of front panel

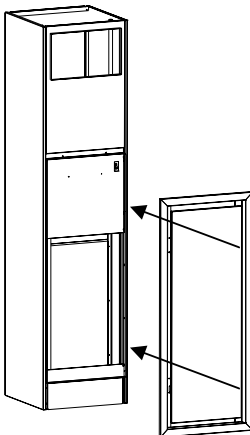

4. Assemble the filter to the front of evaporator

5. Assemble the return panel to the cabinet mating to hinge

Installation

- General Installation Checks

The checklist below is a summary of the steps required to successfully install a unit. This checklist is intended to acquaint the installing personnel with procedures required in the installation process. It does not replace the detailed instructions called out in the applicable sections of this manual.

1. Remove packaging and inspect the unit. Check the unit for shipping damage and material shortage; file a freight claim and notify appropriate sales representation.

NOTE

The unit cabinet is packaged in a cardboard.
The chassis sits inside a cardboard tray with an upper box for protection.

2. Verify the correct model, options and voltage from the unit nameplate.
3. Verify the installation location of the unit will provide the required clearance for proper operation.
4. Remove refrigeration access panel and inspect the unit. Be certain the refrigerant tubing has clearance from adjacent parts.

- Hazardous Voltage

Disconnect all electric power, including remote disconnects and discharge all motor start/run capacitors before servicing. Follow proper lockout/tagout procedures to ensure the power can not be inadvertently energized. Failure to disconnect power before servicing could result in death or serious injury. The transformer is located in the chassis control box.

- Main Electrical

1. Verify the power supply complies with the unit nameplate specifications.
2. Inspect all control panel components; tighten any loose connections.
3. Connect properly sized and protected power supply wiring to a field-supplied/installed disconnect switch and to the unit power block in the unit's cabinet control box for equipment.
4. Install proper grounding wires to an earth ground.

NOTE

All field-installed wiring must comply with NEC and applicable local codes.

- Low Voltage Wiring (AC & DC) Requirements

Connect properly sized control wiring to the proper termination points between the field supplied thermostat and the terminal plug in the equipment's junction box.

- Field Installed Power Wiring

Power wiring to the equipment must conform to National and Local Electric Codes (NEC) by a professional electrician.

- Live Electrical Components

During installation, testing, servicing and troubleshooting of this product, it may be necessary to work with live electrical components. Have a qualified licensed electrician or other individual who has been properly

trained in handling live electrical components perform these tasks. Failure to follow all electrical safety precautions when exposed to live electrical components could result in death or serious injury. Verify that the power supply available is compatible with the unit's nameplate. Use only copper conductors to connect the power supply to the unit.

- Use Copper Conductors Only

Unit terminals are not designed to accept other types of conductors. Failure to use copper conductors may result in equipment damage. Main Unit Power Wiring A field supplied disconnect switch must be installed at or near the unit in accordance with the National Electric Code (NEC latest edition).

- Return Air (hinged) Acoustical Door

The hinged acoustical door is recessed into the wall so that the door is flush with the surface of the wall. The opening through the wall for the door assembly must be centered with the return-air opening of the unit cabinet. For full installing instructions of the return-air acoustical door.

- Drywall Installation

Before installing drywall around cabinet. Cover the cabinet supply and return openings with plastic or cardboard to help prevent dust or construction debris from reaching unit components. Warranties will be voided if paint or foreign debris is allowed to contaminate internal unit components. The location of the drywall may be dependent upon the type of return air access design. Units that contain a field provided return air access assembly, contractor must calculate location of drywall to allow for frame mounting.

- Units utilizing Hinged Acoustic Door Assembly

1. Locate the side studs a minimum of 1 1/4-inches and a maximum of 1 3/8-inches from the cabinet to the side of the stud. This critical dimension, combined with "distance between studs" is used to determine the side-to-side opening for the door, dimension A. The distances provided in the table are a "minimum" dimension. Allow 3 1/2-inches from the front of the cabinet to the sheet rock surface, Top View.
2. The height of the door assembly must be positioned to recess the door 2 1/4-inches from the cabinet's return-air opening, Side View blow-up.
3. Locate dimensions A and B for sheet rock opening size. The position of the sheet rock opening must be centered side-to-side with the return-air opening in the cabinet. Ensure the bottom of the sheet rock opening is 2 1/4-inches below the return-air opening in the cabinet. This allows the door recess to rest on the bottom of the sheet rock opening for proper vertical placement of the door.
4. Place the door frame into the sheet rock opening. A positive seal is critical between the back of the door frame and the front of the cabinet. Ensure that the gasket material seals properly.

NOTE

When placing the sheet rock panel, make certain the opening for the door is centered with the return-air opening in the cabinet ($\pm 1/8"$).

- Chassis Installation

1. Connect water coil pipe to the system with a flexible steel hose assembly.
2. Verify that the shut-off/balancing valve in the return line/supply line are closed.
3. Place shut-off valves in appropriate location (see sticker on the equipment for best placement recommendation) to allow chassis to slide easily in/out of unit cabinetry.
4. Flush system. See Cleaning and Flushing the Water Loop for flushing instructions.
5. Open the unit water valves and check piping for leaks.
6. Connect electrical to unit chassis via the quick connect mating plugs.

NOTE

Four plugs are included (motor, optional condensate overflow, power and thermostat).

7. Slide chassis into the cabinet. Center the chassis left to right to minimize sound transmission.
8. Verify unit's air filter is properly place in the chassis filter rack.
9. Install cabinet's front cover to the hinged door.
10. Ensure the gasket material creates a positive seal around the entire coil to avoid coil bypass. If a field supplied door is used, ensure the front cover is attached to the building structure and not the unit cabinet.

- Supply Grille Installation

1. Install the supply grille(s) into the cabinet discharge opening. Insure there are no air gaps between the cabinet supply air and the grille. This helps prevent recirculation of supply air into the return air opening behind the drywall.
2. Secure grille(s) into the drywall via two screws.

- Cleaning and Flushing the Water Loop

1. After the piping system is complete, the flexible hose connectors should be doubled back to complete the water circuit external to the unit (avoiding trash settle-out in the condenser). An extra pipe may be necessary to connect the hose kits. See next page for antifreeze/water mixture by volume.
2. Water circulation system should be filled with clean water using the water make up connections.

NOTE

Air vents should be opened during filling.

3. With the air vents closed, start the circulating pump and then crack the air vents to bleed off the trapped air, assuring circulation through all components of the system.

NOTE

Make up water must be available to the system to replace the volume formerly occupied by the air that is bled off.

4. With the air vented and the water circulating, the entire system should be checked for leaks with repairs made as required.
5. Operate the supplementary heat system making checks per manufacturer's instructions. During this operation, visual checks should be made for leaks that may have occurred due to increased heat. Repair as required.
6. Open the system at the lowest point for the initial blow down (making sure the make up water is equal to the water being dumped). Continue blow down until the water leaving the drain runs clear, but not less than 2 hours.

- Shut down pumps and supplementary heat system. Reconnect the hoses placing the water-to-refrigerant heat exchanger in the water circulating system.

NOTE

Vents should be open when the pumps and supplementary heat system are shut down.

- Using Antifreeze

In areas of the country where entering water temperatures drop below 45°F or where piping is being run through areas subject to freezing, the loop must be freeze protected by using an approved antifreeze solution to prevent loop water from freezing inside the heat exchanger. Methanol and glycols are the most commonly used antifreeze solutions. Consult your geothermal unit supplier for locally approved solutions in your area. Propylene glycol is not recommended in installations where the water temperature are expected to fall below 30°F. At extreme temperatures, the viscosity increases to the point where normal loop circulating pumps may not maintain proper flow. If propylene glycol is the only locally approved solution for anti-freeze, good engineering practices should be used to achieve the desired flow. Calculate the approximate volume of water in the system by using the requirements detailed in the following table, Water Volume. Add three gallons to this total to allow for the water contained in the hose kit and geothermal unit.

Type of Antifreeze	Minimum Temperature for Freeze Protection				
	10°F	15°F	20°F	25°F	30°F
Methanol	25%	21%	16%	10%	3%
Propylene Glycol	-	-	-	-	6%

Pre-Start-up Checklist

Before energizing the unit, the following system devices must be checked:

- Is the high voltage power supply correct and in accordance with the nameplate ratings?
- Is the field wiring and circuit protection the correct size?
- Is the low voltage control circuit wiring correct per the unit wiring diagram?
- Is the piping system clean/complete and correct? (A recommendation of all system flushing o debris from the water-to-refrigerant heat exchanger, along with air purging from the water-to-refrigerant heat exchanger be done in accordance with the Closed-Loop Source Heat Pump Systems Installation Guide).
- Is vibration isolation provided? (i.e. unit isolation pad, hose kits)
- Is unit serviceable? (See clearance specifications).
- Are the low/high-side pressure temperature caps secure and in place?
- Are all the unit access panels secure and in place?
- Is the thermostat in the OFF position?
- Is the water flow established and circulating through all the units?
- Is the duct work (if required) correctly sized, run, taped, insulated and weather proofed with proper unit arrangement?
- Is the condensate line properly sized, run, trapped and pitched?
- Does the indoor blower turn freely without rubbing?
- Has all work been done in accordance with applicable local and national codes?
- Has heat transfer fluid been added in the proper mix to prevent freezing in closed system application?
- Have the chassis isolation rails been released?
- Is there a good seal between the front air panel and the coil?

Maintenance

- Preventive Maintenance

Maintenance on the unit is simplified with the following preventive suggestions: Filter maintenance must be performed to assure proper operation of the equipment. Filters should be inspected at least every three months, and replaced when it is evident they are dirty.

Check the contactors and relays within the control panel at least once a year. It is good practice to check the tightness of the various wiring connections within the control panel. A strainer (60 mesh or greater) must be used on an open loop system to keep debris from entering the unit heat exchanger and to ensure a clean system. For units on well water, it is important to check the cleanliness of the water-to-refrigerant heat exchanger. Should it become contaminated with dirt and scaling as a result of bad water, the heat exchanger will have to be back flushed and cleaned with a chemical that will remove the scale. This service should be performed by an experienced service person.

- Hazardous Chemicals

Coil cleaning agents can be either acidic or highly alkaline. Handle chemical carefully. Proper handling should include goggles or face shield, chemical resistant gloves, boots, apron or suit as required. For personal safety, refer to the cleaning agent manufacturers Materials Safety Data Sheet and follow all recommended safe handling practices. Failure to follow all safety instructions could result in death or serious injury. It should be noted that the water quality should be checked periodically. See the following water quality table.

Scaling	Calcium and magnesium(total hardness)	Less than 350 ppm
	pH	7 ~ 9.5
Corrosion	Hydrogen Sulfide	Less than 1 ppm
	Sulfates	Less than 25 ppm
	Chlorides	Less than 125 ppm
	Carbon Dioxide	Less than 75 ppm
	Total dissolved solids(TDS)	Less than 1000 ppm
	Biological Growth	Iron Bacteria
Erosion	Suspended Solids	Low

Operating range

(unit : Fahrenheit, °F)

	Cooling	Heating
Air	64.4~89.6	50~69.8
Water	59~104	59~104

