

This Owner's Manual is provided and hosted by [Appliance Factory Parts](#).



LG ARNU073SER2 Owner's Manual

[Shop genuine replacement parts for LG ARNU073SER2](#)



[Find Your LG Air Conditioner Parts - Select From 2328 Models](#)

----- Manual continues below -----



website <http://www.lgservice.com>

LG

MULTI V™ System Indoor Unit (2 Series)

INSTALLATION MANUAL

Type : ART COOL Mirror

ENGLISH

FRANÇAIS

ESPAÑOL

IMPORTANT

- Please read this installation manual completely before installing the product.
- Installation work must be performed in accordance with the national wiring standards by authorized personnel only.
- Please retain this installation manual for future reference after reading it thoroughly.

IMPORTANT!

Please read this instruction sheet completely before installing the product.

This air conditioning system meets strict safety and operating standards. As the installer or service person, it is an important part of your job to install or service the system so it operates safely and efficiently.

WARNING

- Installation or repairs made by unqualified persons can result in hazards to you and others. Installation MUST conform with local building codes or, in the absence of local codes, with the National Electrical Code NFPA 70/ANSI C1-1993 or current edition and Canadian Electrical Code Part1 CSA C.22.1.
- The information contained in the manual is intended for use by a qualified service technician familiar with safety procedures and equipped with the proper tools and test instruments.
- Failure to carefully read and follow all instructions in this manual can result in equipment malfunction, property damage, personal injury and/or death.

CAUTION: Improper installation, adjustment, alteration, service or maintenance can void the warranty. The weight of the condensing unit requires caution and proper handling procedures when lifting or moving to avoid personal injury. Use care to avoid contact with sharp or pointed edges.

Safety Precautions

- Always wear safety eye wear and work gloves when installing equipment.
- Never assume electrical power is disconnected. Check with meter and equipment.
- Keep hands out of fan areas when power is connected to equipment.
- R-410A causes frostbite burns.
- R-410A is toxic when burned.

NOTE TO INSTALLING DEALER: The Owners Instructions and Warranty are to be given to the owner or prominently displayed near the indoor Furnace/Air Handler Unit.

Special warnings

When wiring:

Electrical shock can cause severe personal injury or death. Only a qualified, experienced electrician should attempt to wire this system.

- Do not supply power to the unit until all wiring and tubing are completed or reconnected and checked.
- Highly dangerous electrical voltages are used in this system. Carefully refer to the wiring diagram and these instructions when wiring. Improper connections and inadequate grounding can cause accidental injury or death.
- Ground the unit following local electrical codes.
- Connect all wiring tightly. Loose wiring may cause overheating at connection points and a possible fire hazard.

When transporting:

Be careful when picking up and moving the indoor and outdoor units. Get a partner to help, and bend your knees when lifting to reduce strain on your back. Sharp edges or thin aluminum fins on the air conditioner can cut your finger.

When installing...

... **in a wall:** Make sure the wall is strong enough to hold the unit's weight.

It may be necessary to construct a strong wood or metal frame to provide added support.

... **in a room:** Properly insulate any tubing run inside a room to prevent "sweating" that can cause dripping and water damage to wall and floors.

... **in moist or uneven locations:** Use a raised concrete pad or concrete blocks provide a solid, level foundation for the outdoor unit. This prevents water damage and abnormal vibration.

... **in an area with high winds:** Securely anchor the outdoor unit down with bolts and a metal frame. Provide a suitable air baffle.

... **in a snowy area(for Heat Pump Model):** Install the outdoor unit on a raised platform that is higher than drifting snow. Provide snow vents.

When connecting refrigerant tubing

- Keep all tubing runs as short as possible.
- Use the flare method for connecting tubing.
- Check carefully for leaks before starting the test run.

When servicing

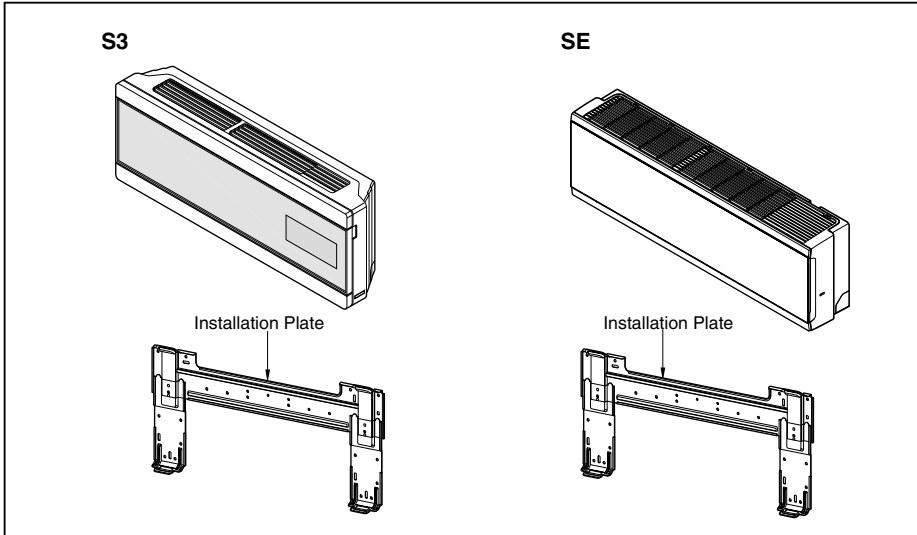
- Turn the power OFF at the main power box(mains) before opening the unit to check or repair electrical parts and wiring.
- Keep your fingers and clothing away from any moving parts.
- Clean up the site after you finish, remembering to check that no metal scraps or bits of wiring have been left inside the unit being serviced.

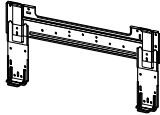


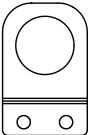
TABLE OF CONTENTS

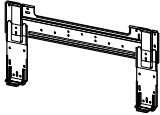


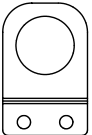
<i>Installation Requirements</i>	<i>Required Parts</i>	<i>Required Tools</i>
Installation Parts4		
Safety Precautions5		
Installation	<input type="checkbox"/> Installation guide map <input type="checkbox"/> Four type "A" screws & plastic anchors <input type="checkbox"/> Connecting cable	<input type="checkbox"/> Level gauge <input type="checkbox"/> Screw driver <input type="checkbox"/> Electric drill <input type="checkbox"/> Hole core drill <input type="checkbox"/> Horizontal meter
Selection of the best location8		
Piping Method.....9	<input type="checkbox"/> Pipes: Gas side Liquid side (Refer to Product Data) <input type="checkbox"/> Insulation materials <input type="checkbox"/> Additional drain pipe	<input type="checkbox"/> Flaring tool set <input type="checkbox"/> Specified torque wrenches (different depending on model No.) <input type="checkbox"/> SpannerHalf union
Drain Piping13		<input type="checkbox"/> A glass of water <input type="checkbox"/> Screw driver
Wiring Connection14		
Installation of Wireless Remote Controller15		<input type="checkbox"/> Hexagonal wrench <input type="checkbox"/> Gas-leak detector <input type="checkbox"/> Vacuum pump <input type="checkbox"/> Gauge manifold
Installation of Wired Remote Controller.....16	<input type="checkbox"/> Two type "B" screws	<input type="checkbox"/> Owner's manual <input type="checkbox"/> Thermometer <input type="checkbox"/> Holder Remote Controller
Optional Operation of Wired Remote Controller18		
Group Control Setting19		

ENGLISH

Installation Parts



S3	
Installation plate(1EA)	
	
Type "A" screws and plastic anchors(4 EA)	Type "B" screw (2 EA)
	
Conduit mounting plate(1EA)	
	

SE	
Installation plate(1EA)	
	
Type "A" screws and plastic anchors(4 EA)	Type "B" screw (2 EA)
	
Conduit mounting plate(1EA)	
	

Safety Precautions

To prevent injury to the user or other people and property damage, the following instructions must be followed.

- Be sure to read before installing the air conditioner.
- Be sure to observe the cautions specified here as they include important items related to safety.
- Incorrect operation due to ignoring instruction will cause harm or damage. The seriousness is classified by the following indications.

⚠ WARNING This symbol indicates the possibility of death or serious injury.

⚠ CAUTION This symbol indicates the possibility of injury or damage to properties only.

■ Meanings of symbols used in this manual are as shown below.

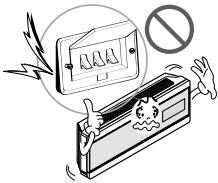
	Be sure not to do.
	Be sure to follow the instruction.

⚠ WARNING

■ Installation

Do not use a defective or under-rated circuit breaker. Use this appliance on a dedicated circuit.

- There is risk of fire or electric shock.



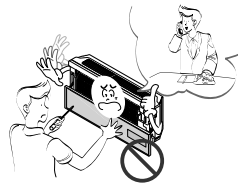
Install the panel and the cover of control box securely.

- There is risk of fire or electric shock.



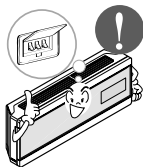
For electrical work, contact the dealer, seller, a qualified electrician, or an Authorized Service Center.

- Do not disassemble or repair the product. There is risk of fire or electric shock.



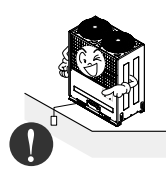
Always install a dedicated circuit and breaker.

- Improper wiring or installation may cause fire or electric shock



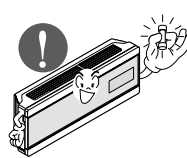
Always ground the product.

- There is risk of fire or electric shock.



Use the correctly rated breaker or fuse.

- There is risk of fire or electric shock.

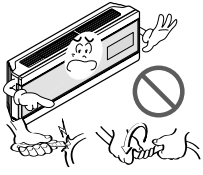


ENGLISH

Safety Precautions

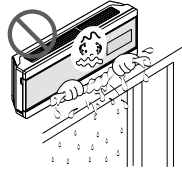
Do not modify or extend the power cable.

- There is risk of fire or electric shock.



Do not let the air conditioner run for a long time when the humidity is very high and a door or a window is left open.

- Moisture may condense and wet or damage furniture.



Be cautious when unpacking and installing the product.

- Sharp edges could cause injury. Be especially careful of the case edges and the fins on the condenser and evaporator.



For installation, always contact the dealer or an Authorized Service Center.

- There is risk of fire, electric shock, explosion, or injury.



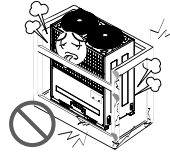
Do not install the product on a defective installation stand.

- It may cause injury, accident, or damage to the product.



Be sure the installation area does not deteriorate with age.

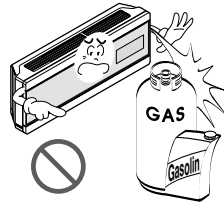
- If the base collapses, the air conditioner could fall with it, causing property damage, product failure, and personal injury.



■ Operation

Do not store or use flammable gas or combustibles near the product.

- There is risk of fire or failure of product.

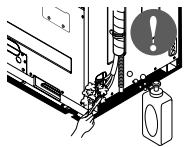


CAUTION

Installation

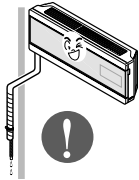
Always check for gas (refrigerant) leakage after installation or repair of product.

- Low refrigerant levels may cause failure of product.



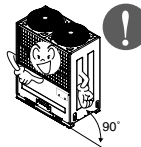
Install the drain hose to ensure that water is drained away properly.

- A bad connection may cause water leakage.



Keep level even when installing the product.

- To avoid vibration or water leakage.



Do not install the product where the noise or hot air from the outdoor unit could damage the neighborhoods.

- It may cause a problem for your neighbors.



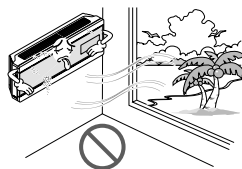
Use two or more people to lift and transport the product.

- Avoid personal injury.



Do not install the product where it will be exposed to sea wind (salt spray) directly.

- It may cause corrosion on the product. Corrosion, particularly on the condenser and evaporator fins, could cause product malfunction or inefficient operation.



ENGLISH

If you eat the liquid from the batteries, brush your teeth and see doctor. Do not use the remote if the batteries have leaked.

- The chemicals in batteries could cause burns or other health hazards.

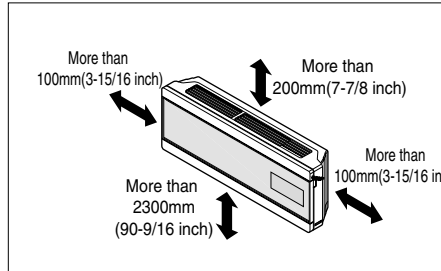


Installation

Read completely, then follow step by step.

Selection of the best location

- There should not be any heat source or steam near the unit.
- There should not be any obstacles to prevent the air circulation.
- A place where air circulation in the room will be good.
- A place where drainage can be easily obtained.
- A place where noise prevention is taken into consideration.
- Do not install the unit near the door way.
- Ensure the spaces indicated by arrows from the wall, ceiling, fence, or other obstacles.

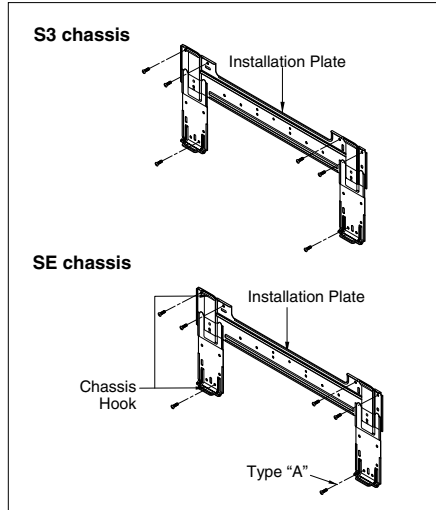


The mounting wall should be strong and solid enough to protect it from the vibration.

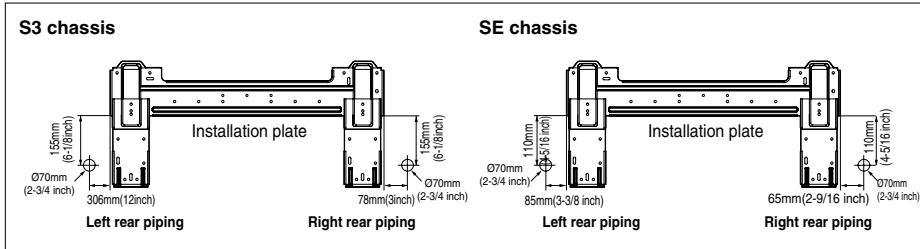
Mount the installation plate on the wall with four Type "A" screws.

(If mounting the unit on the concrete wall, consider using anchor bolts.)

- Always mount the Installation plate horizontally by aligning the marking-off line by means of the thread and a level.



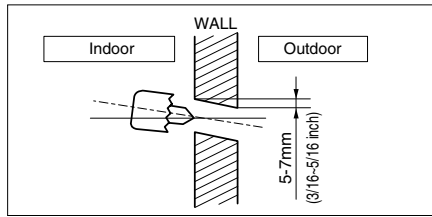
The lower left and the right side of Installation Plate



CAUTION : In case that the unit is installed near the sea, the installation parts may be corroded by salt. The installation parts (and the unit) should be taken appropriate anti-corrosion measures.

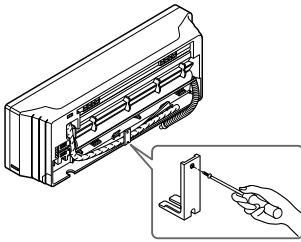
Drill a Hole in the Wall

- Drill the piping hole with a $\varnothing 70\text{mm}$ hole core drill. Drill the piping hole at either the right or the left with the hole slightly slanted to the outdoor side.

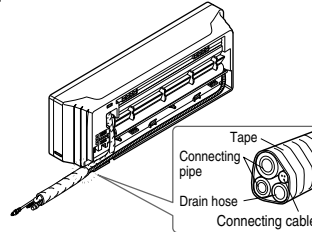


Piping Method

- Preparing the indoor unit's piping and drain hose for installation through the wall.
- Remove the plastic tubing retainer (see illustration below) and pull the tubing and drain hose away from chassis.
- Replace the plastic tubing holder in the original position.



3. **Tape the tubing, drain hose and the connecting cable.** Be sure that the drain hose is located at the lowest side of the bundle. Locating at the upper side can cause drain pan to overflow inside the unit.

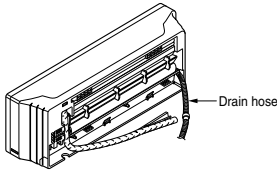


NOTICE : If the drain hose is routed inside the room, insulate the hose with an insulation material* so that dripping from "sweating"(condensation) will not damage furniture or floors.

*Foamed polyethylene or equivalent is recommended.

For right rear piping

1. **Route the indoor tubing and the drain hose in the direction of rear left.**

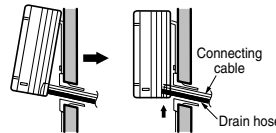


2. **Insert the connecting cable into the indoor unit from the outdoor unit through the piping hole.**

- Do not connect the cable to the indoor unit.
- Make a small loop with the cable for easy connection later.

4. Indoor unit installation

- Hook the indoor unit onto the upper portion of the installation plate. (Engage the two hooks of the rear top of the indoor unit with the upper edge of the installation plate.) Ensure that the hooks are properly seated on the installation plate by moving it left and right.



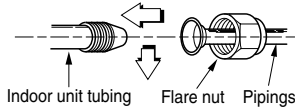
Press the lower left and right sides of the unit against the installation plate until the hooks engage into their slots (clicking sound).

ENGLISH

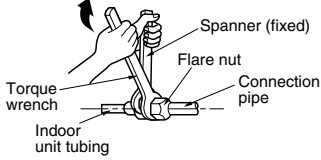
Installation

5. Connecting the pipings to the indoor unit and drain hose to drain pipe.

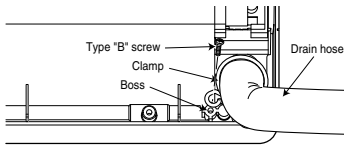
- Align the center of the pipings and sufficiently tighten the flare nut by hand.



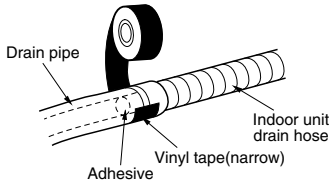
- Tighten the flare nut with a wrench.



- Mount the clamp on the boss with a type "B" screw. (optional)

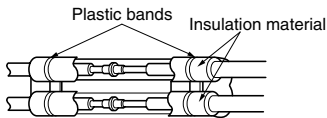


- When extending the drain hose at the indoor unit, install the drain pipe.

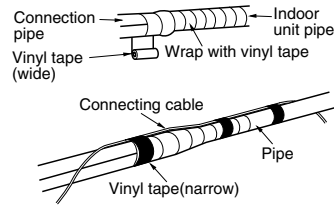


6. Wrap the insulation material around the connecting portion.

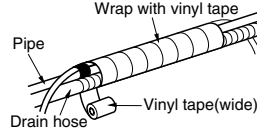
- Overlap the connection pipe insulation material and the indoor unit pipe insulation material. Bind them together with vinyl tape so that there is no gap.



- Wrap the area which accommodates the rear piping housing section with vinyl tape.

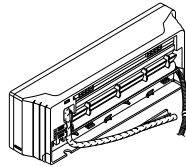


- Bundle the piping and drain hose together by wrapping them with vinyl tape over the range within which they fit into the rear piping housing section.

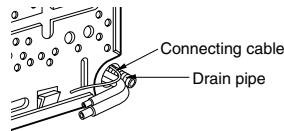


For left rear piping

- Route the indoor tubing and the drain hose to the required piping hole position.



- Insert the piping, drain hose and the connecting cable into the piping hole.

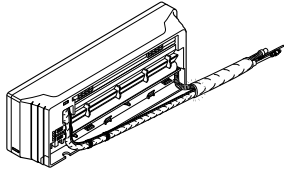


3. Insert the connecting cable into the indoor unit.

- Don't connect the cable to the indoor unit.
- Make a small loop with the cable for easy connection later.

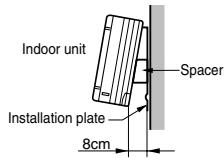
4. Tape the drain hose and the connecting cable.

- Connecting cable



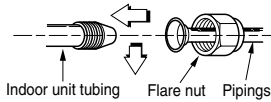
5. Indoor unit installation

- Hang the indoor unit from the hooks at the top of the installation plate.
- Insert the spacer etc. between the indoor unit and the installation plate and separate the bottom of the indoor unit from the wall.

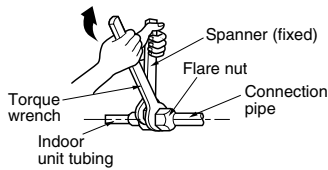


6. Connecting the pipings to the indoor unit and the drain hose to drain pipe.

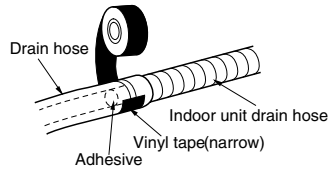
- Align the center of the pipings and sufficiently tighten the flare nut by hand.



- Tighten the flare nut with a wrench.

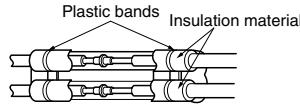


- When extending the drain hose at the indoor unit, install the drain pipe.

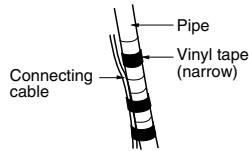
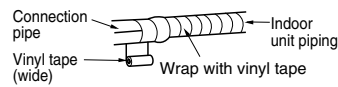


7. Wrap the insulation material around the connecting portion.

- Overlap the connection pipe heat insulation and the indoor unit pipe heat insulation material. Bind them together with vinyl tape so that there is no gap.



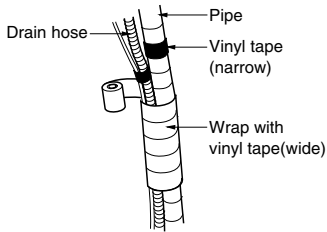
- Wrap the area which accommodates the rear piping housing section with vinyl tape.



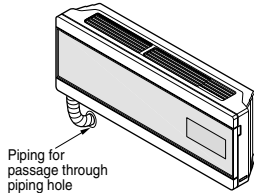
ENGLISH

Installation

- Bundle the piping and drain hose together by wrapping them with cloth tape over the range within which they fit into the rear piping housing section.

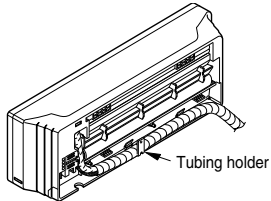


8. Reroute the pipings and the drain hose across the back of the chassis.



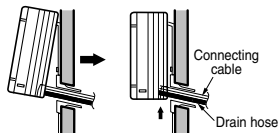
9. Set the pipings and the drain hose to the back of the chassis with the tubing holder.

- Hook the edge of tubing holder to tap on chassis and push the bottom of tubing holder to be engaged at the bottom of chassis.



10. Indoor unit installation

- Remove the spacer.
- Ensure that the hooks are properly seated on the installation plate by moving it left and right.



Press the lower left and right sides of the unit against the installation plate until the hooks engage into their slots (clicking sound).

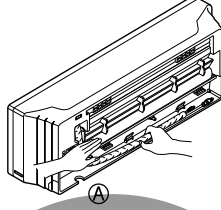
CAUTION

Installation Information (For left piping)

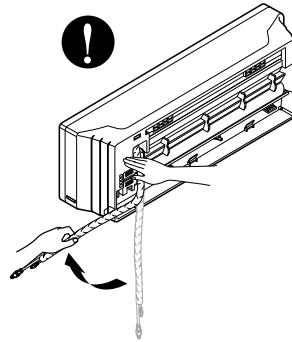
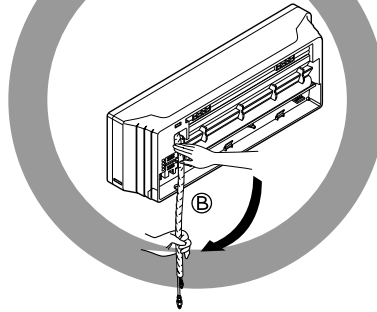
• Good case

For left piping. Follow the instruction below.

- Press on the upper side of clamp. (A)



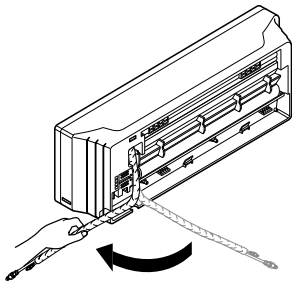
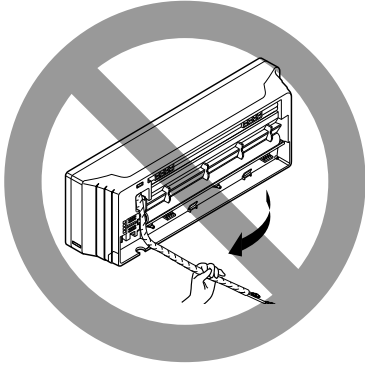
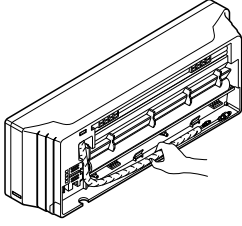
- Unfold the tubing to downward slowly. (B)



CAUTION

• Bad case

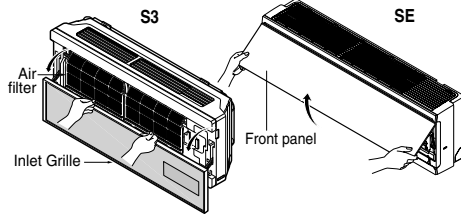
- Following bending type from right to left could cause problem of pipe damage.



Drain Piping

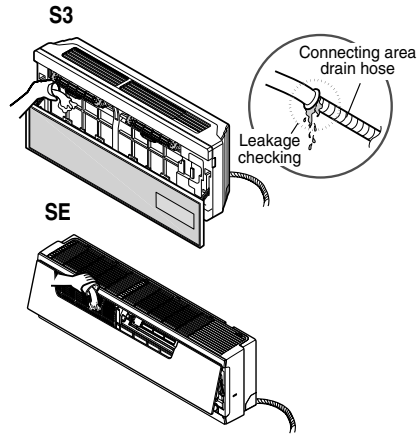
1. To remove the front panel from the indoor unit, remove the front panel from the indoor unit cabinet.

- Set the air direction louvers up-and-down to the position(horizontally) by hand.
- Remove the securing screws that retain the front panel. Pull the lower left and right sides of the grille toward you and lift it off.

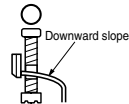


2. To check the drainage.

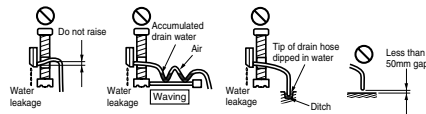
- Pour a glass of water on the evaporator.
- Ensure the water flows through the drain hose of the indoor unit without any leakage and goes out the drain exit.



- The drain hose should point downward for easy drain flow.



- Do not make drain piping.

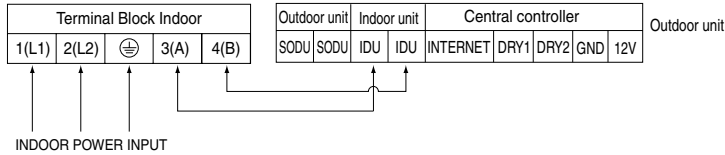
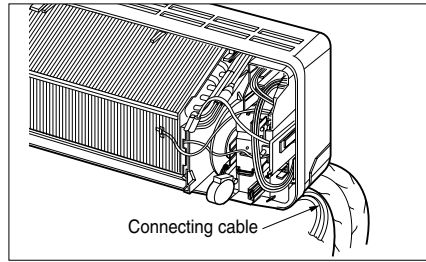


ENGLISH

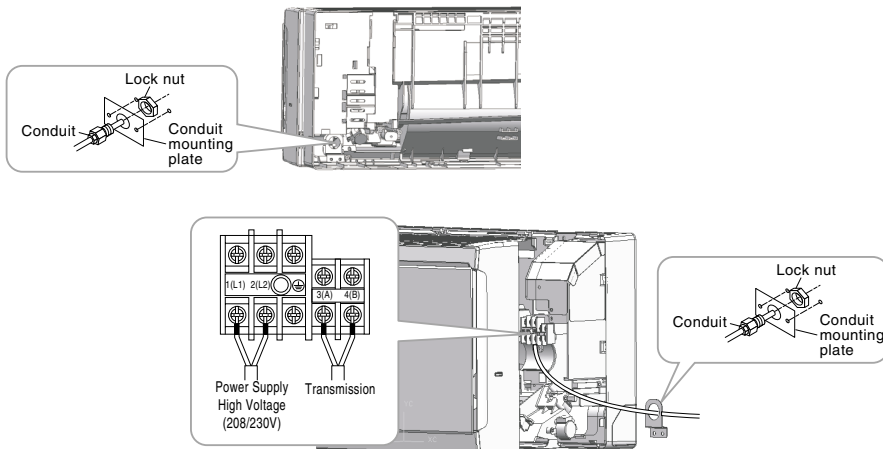
Wiring Connection

Connect the wires to the terminals on the control board individually according to the outdoor unit connection.

- Ensure that the color of the wires of outdoor unit and the terminal No. are the same as those of indoor unit respectively.



Connection method of the connecting cable(Example)



⚠ WARNING : Loose wiring may cause the terminal to overheat or result in unit malfunction.
A fire hazard may also exist.
Therefore, be sure all wiring is tightly connected.

⚠ CAUTION:

After the confirmation of the above conditions, prepare the wiring as follows:

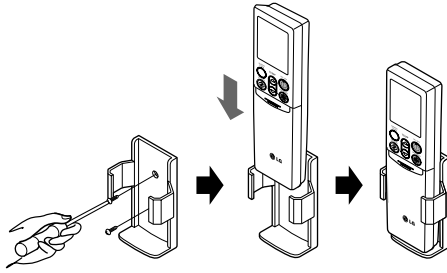
- 1) Never fail to have an individual power circuit specifically for the air conditioner. As for the method of wiring, be guided by the circuit diagram posted on the inside of control cover.
- 2) The screw which fasten the wiring in the casing of electrical fittings are liable to come loose from vibrations to which the unit is subjected during the course of transportation. Check them and make sure that they are all tightly fastened. (If they are loose, it could cause burn-out of the wires.)

- 3) Specification of power source.
- 4) Confirm that electrical capacity is sufficient.
- 5) See to that the starting voltage is maintained at more than 90 percent of the rated voltage marked on the name plate.
- 6) Confirm that the cable thickness is as specified in the power source specification.
(Particularly note the relation between cable length and thickness.)
- 7) In a wet or moist area, always install an earth leakage circuit breaker.
- 8) The following would be caused by voltage drop.
 - Vibration of a magnetic switch, which will damage the contact point, fuse breaking, disturbance of the normal function of the overload.
- 9) The means for disconnection from a power supply shall be incorporated in the fixed wiring and have an air gap contact separation of at least 3mm in each active(phase) conductors.

Installation of Wireless Remote Controller

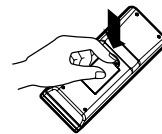
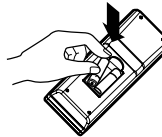
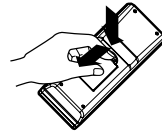
ENGLISH

How to mount onto a wall



How to insert the batteries

1. Remove the battery cover by pulling it according to the arrow direction.
2. Insert new batteries making sure that the (+) and (-) of battery are installed correctly.
3. Reattach the cover by sliding it back into position.



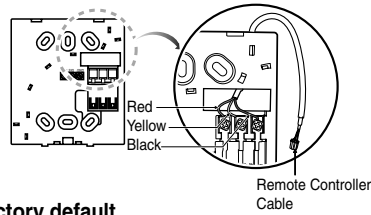
NOTICE

1. Always use/replace both batteries of same type.
2. If the system is not to be used for a long time, remove the batteries to save their working life.
3. If the display screen of remote controller starts, fading replace both of the batteries.

Installation of Wired Remote Controller

1. Connect the wired remote controller cable to the wired remote controller installation board as shown in the right picture.

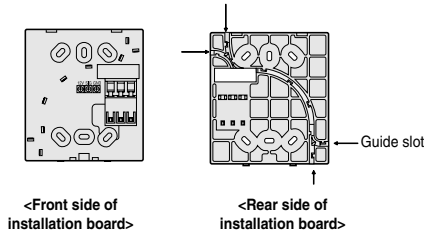
12V	Red wire
SIG	Yellow wire
GND	Black wire



* The wired remote controller cable is connected as factory default.

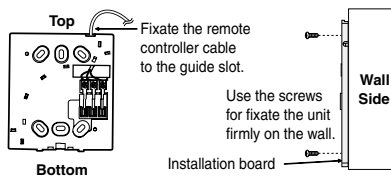
2. After fixing the cable to the guide slot, attach the wired remote controller installation board at the desired location.

- Before fixing the wired remote controller cable to the guide slot, remove any clogged part of the case in the direction to install before the installation.

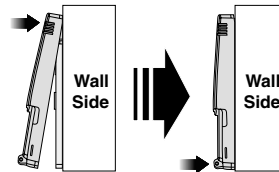


3. After locating the wired remote controller installation board at the desired location, screw the unit firmly. (When there is a buried box, install the wired remote controller board to fit the buried box.)

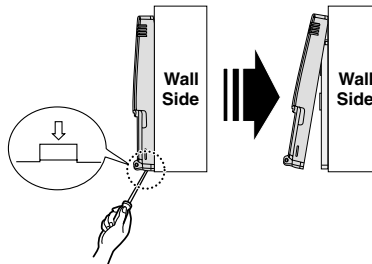
- Use the screw provided.



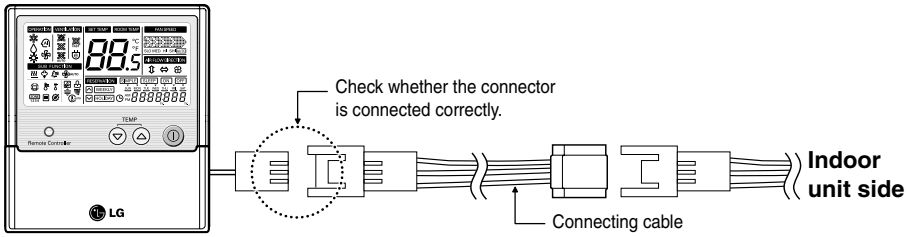
4. After fixing the top part of the wired remote controller to the installation board as shown in beside picture, press the bottom part to assemble the controller to its board.



When disassemble the wired remote controller from the installation board, use the driver as shown in the right picture and insert it into the hole with the arrow. And when you pull the driver in the front direction, the wired remote controller will be separated.



5. Use the connecting cable to connect the indoor unit and the wired remote controller.



6. When the distance between the wired remote controller and the indoor unit is 10m and above, use the extension cable.

CAUTION

When installing the wired remote controller, do not bury it in the wall.

(It can cause damage in the temperature sensor.)

Do not install the cable to be 50m or above.

(It can cause communication error.)

- When installing the extension cable, check the connecting direction of the connector of the remote controller side and the product side for correct installation.
- If you install the extension cable in the opposite direction, the connector will not be connected.
- Specification of extension cable: 2547 1007 22# 2 core 3 shield 5 or above.

ENGLISH

Optional Operation of Wired Remote Controller

Two Thermistor System

1. Press button for 4 seconds to enter the installer setting mode until timer segment display "01:01".

2. Repeat pressing button to select Function code 04.

04:01

Function Code Thermistor setting

3. Set Thermistor mode by pressing button (01: Remote Controller, 02: Indoor, 03: 2TH)

4. Press button to save or release

5. Press button to exit or system will automatically exit after 25 seconds without any input.

* Therefore system will use value that sensed from indoor unit or remote controller

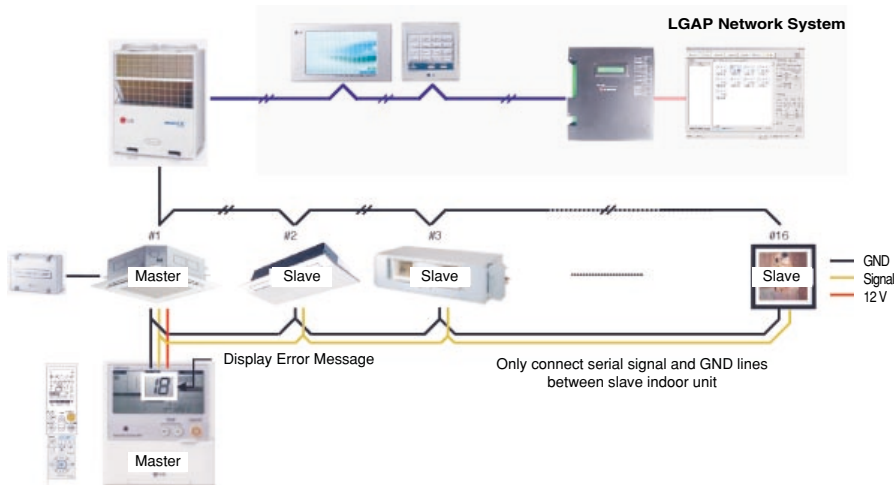
Temperature sensor location		Function
01	Remote controller	Operation in remote controller Temperature sensor
02	Indoor unit	Operation in indoor unit temperature sensor
03	2-Thermistor	Operation in lower temperature after comparing the temperature between the indoor unit and remote controller

* If you want to know more Optional Operation, please refer to Wired Remote Controller Manual.

Group Control Setting

1. Group Control 1

■ Wired remote controller 1 + Indoor units



ENGLISH

1. It is possible to 16 indoor units(Max) by one wired remote controller.

Set only one indoor unit to Master, set the others to Slave.

2. It is possible to connect with every type of indoor units.

3. It is possible to use wireless remote controller at the same time.

4. It is possible to connect with Dry Contact and Central controller at the same time.

The Master indoor unit is possible to recognize Dry Contact and Central controller only.

5. In case of any error occurs at indoor unit, display on the wired remote controller.

Exception of the error indoor unit, an individual indoor unit control possibility.

6. In case of Group Control, be limited additional functions of indoor unit.

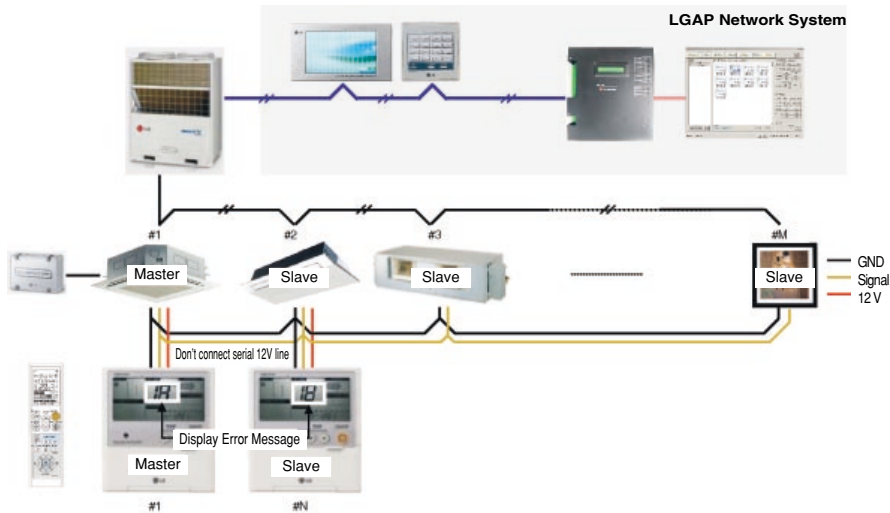
- Selection of operation options (stop/mode/temperature)
- Control of flow rate (strong/middle/weak)
- Time reservation function
- Elevation grille

* All kind of indoor units be set possible using a wireless remote controller, except cassette and duct types.
Refer to wireless remote controller manual for setting group control.

* It is possible to connect indoor units since Feb. 2009.
In the other cases, please contact LGE.

2. Group Control 2

■ Wired remote controllers + Indoor units



1. It is possible to control N indoor units by wired remote controller M units. ($M+N \leq 17$ Units)

Set only one indoor unit to Master, set the others to Slave.
 Set only one wired remote controller to Master, set the others to Slave.
 Other than those, it is same with the Group Control 1.

2. It is possible to connect with every type of indoor units.

3. It is possible to use wireless remote controller at the same time.

4. It is possible to connect with Dry Contact and Central controller at the same time.

The Master indoor unit is possible to recognize Dry Contact and Central controller only.

5. In case of any error occurs at indoor unit, display on the wired remote controller.

Exception of the error indoor unit, an individual indoor unit control possibility.

6. In case of Group Control, be limited additional functions of indoor unit.

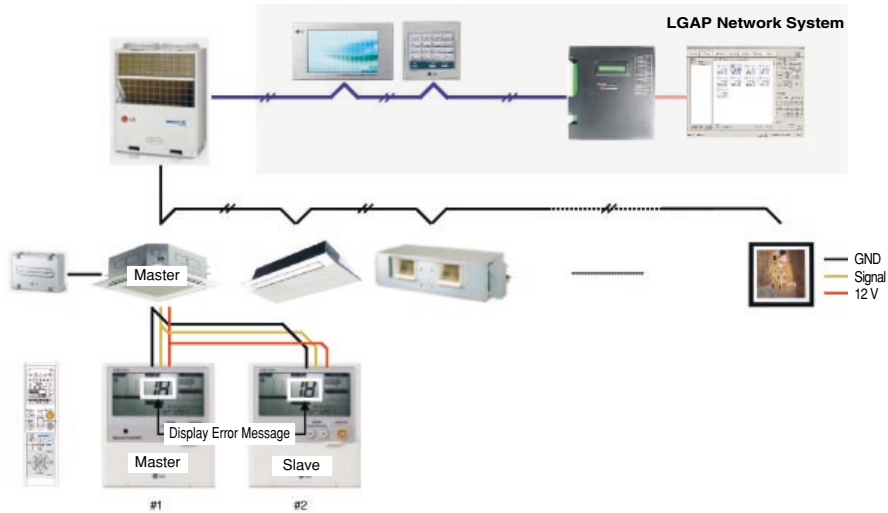
- Selection of operation options (stop/mode/temperature)
- Control of flow rate (strong/middle/weak)
- Time reservation function
- Elevation grille

* All kind of indoor units be set possible using a wireless remote controller, except cassette and duct types.
 Refer to wireless remote controller manual for setting group control.

* It is possible to connect indoor units since Feb. 2009.
 In the other cases, please contact LGE.

3. 2 Remote Control

■ Wired remote controller 2 + Indoor unit 1



ENGLISH

1. It is possible to connect two wired remote controllers with one indoor unit.
2. Every types of indoor unit is possible to connect two remote controller.
3. It is possible to use wireless remote controller at the same time.
4. It is possible to connect with Dry Contact and Central controller at the same time.
5. In case of any error occurs at indoor unit, display on the wired remote controller.
6. There isn't limits of indoor unit function.



P/No.: MFL42803118

Printed in Korea

After reading this manual, keep it in a place easily accessible to the user for future reference.