

This Owner's Manual is provided and hosted by [Appliance Factory Parts](#).



LG ARNU073TJC2 Owner's Manual

[Shop genuine replacement parts for LG ARNU073TJC2](#)



[Find Your LG HVAC Parts - Select From 50 Models](#)

----- Manual continues below -----



website <http://www.lgservice.com>
e-mail <http://www.lgservice.com/techsup.html>

LG

MULTI V™ System Indoor Unit (2 Series)

INSTALLATION MANUAL

Type: Ceiling Cassette - 1Way

ENGLISH

FRANÇAIS

ESPAÑOL

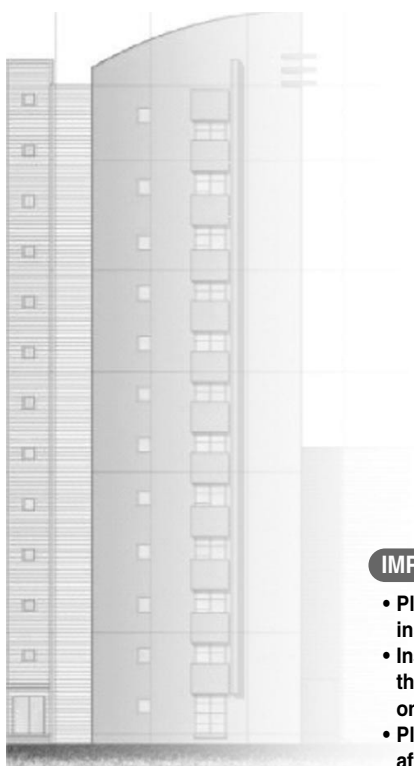

IMPORTANT

- Please read this installation manual completely before installing the product.
- Installation work must be performed in accordance with the national wiring standards by authorized personnel only.
- Please retain this installation manual for future reference after reading it thoroughly.

IMPORTANT!

Please read this instruction sheet completely before installing the product.

This air conditioning system meets strict safety and operating standards. As the installer or service person, it is an important part of your job to install or service the system so it operates safely and efficiently.



WARNING

- Installation or repairs made by unqualified persons can result in hazards to you and others. Installation MUST conform with local building codes or, in the absence of local codes, with the National Electrical Code NFPA 70/ANSI C1-1993 or current edition and Canadian Electrical Code Part1 CSA C.22.1.
- The information contained in the manual is intended for use by a qualified service technician familiar with safety procedures and equipped with the proper tools and test instruments.
- Failure to carefully read and follow all instructions in this manual can result in equipment malfunction, property damage, personal injury and/or death.

CAUTION: Improper installation, adjustment, alteration, service or maintenance can void the warranty. The weight of the condensing unit requires caution and proper handling procedures when lifting or moving to avoid personal injury. Use care to avoid contact with sharp or pointed edges.

Safety Precautions

- Always wear safety eye wear and work gloves when installing equipment.
- Never assume electrical power is disconnected. Check with meter and equipment.
- Keep hands out of fan areas when power is connected to equipment.
- R-410A causes frostbite burns.
- R-410A is toxic when burned.

NOTE TO INSTALLING DEALER: The Owners Instructions and Warranty are to be given to the owner or prominently displayed near the indoor Furnace/Air Handler Unit.



Special warnings

When wiring:

Electrical shock can cause severe personal injury or death. Only a qualified, experienced electrician should attempt to wire this system.

- Do not supply power to the unit until all wiring and tubing are completed or reconnected and checked.
- Highly dangerous electrical voltages are used in this system. Carefully refer to the wiring diagram and these instructions when wiring. Improper connections and inadequate grounding can cause accidental injury or death.
- Ground the unit following local electrical codes.
- Connect all wiring tightly. Loose wiring may cause overheating at connection points and a possible fire hazard.

When transporting:

Be careful when picking up and moving the indoor and outdoor units. Get a partner to help, and bend your knees when lifting to reduce strain on your back. Sharp edges or thin aluminum fins on the air conditioner can cut your finger.

When installing...

- ... **in a wall:** Make sure the wall is strong enough to hold the unit's weight. It may be necessary to construct a strong wood or metal frame to provide added support.
- ... **in a room:** Properly insulate any tubing run inside a room to prevent "sweating" that can cause dripping and water damage to wall and floors.
- ... **in moist or uneven locations:** Use a raised concrete pad or concrete blocks provide a solid, level foundation for the outdoor unit. This prevents water damage and abnormal vibration.
- ... **in an area with high winds:** Securely anchor the outdoor unit down with bolts and a metal frame. Provide a suitable air baffle.
- ... **in a snowy area(for Heat Pump Model):** Install the outdoor unit on a raised platform that is higher than drifting snow. Provide snow vents.

When connecting refrigerant tubing

- Keep all tubing runs as short as possible.
- Use the flare method for connecting tubing.
- Check carefully for leaks before starting the test run.

When servicing

- Turn the power OFF at the main power box(mains) before opening the unit to check or repair electrical parts and wiring.
- Keep your fingers and clothing away from any moving parts.
- Clean up the site after you finish, remembering to check that no metal scraps or bits of wiring have been left inside the unit being serviced.





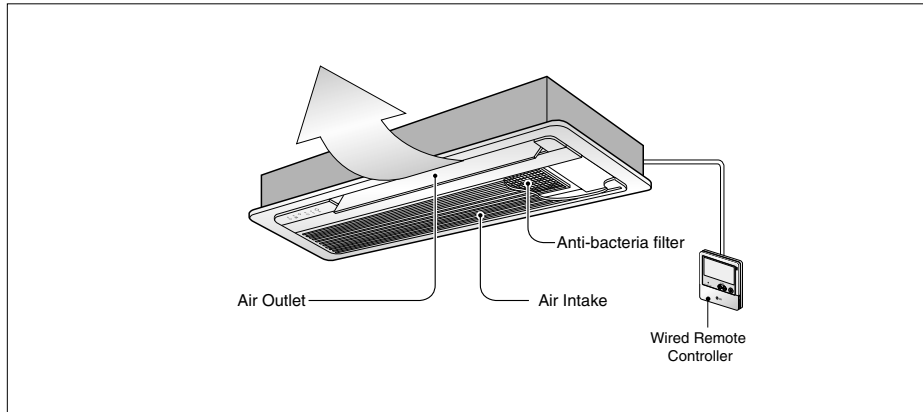

TABLE OF CONTENTS

<i>Installation Requirements</i>	<i>Required Parts</i>	<i>Required Tools</i>
Installation Parts4		
Safety Precautions5		
Installation	<input type="checkbox"/> Installation guide map <input type="checkbox"/> Four type "A" screws & plastic anchors <input type="checkbox"/> Connecting cable	<input type="checkbox"/> Level gauge <input type="checkbox"/> Screw driver <input type="checkbox"/> Electric drill <input type="checkbox"/> Hole core drill <input type="checkbox"/> Horizontal meter <input type="checkbox"/> Flaring tool set <input type="checkbox"/> Specified torque wrenches (different depending on model No.) <input type="checkbox"/> SpannerHalf union
Selection of the best location 8		
Ceiling dimension and hanging bolt location9	<input type="checkbox"/> Pipes: Gas side Liquid side (Refer to Product Data)	
Wiring Connection10	<input type="checkbox"/> Insulation materials <input type="checkbox"/> Additional drain pipe	
Installation of Decoration Panel11		
Drain Piping12		
Installation of Wired Remote Controller.....14		<input type="checkbox"/> Hexagonal wrench <input type="checkbox"/> Gas-leak detector <input type="checkbox"/> Vacuum pump <input type="checkbox"/> Gauge manifold
Optional Operation of Wired Remote Controller.....16		<input type="checkbox"/> Owner's manual <input type="checkbox"/> Thermometer

ENGLISH

Installation Parts

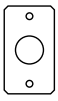

Name	Drain hose	Clamp metal	Washer for hanging bracket	Plastic band	Insulation for fitting	Conduit mounting plate	(Other)
Quantity	1 EA	2 EA	8 EA	4 EA	1 SET	1 EA	<ul style="list-style-type: none"> • Paper pattern for installation • Owner's manual • Installation manual
Shape					 for gas pipe  for liquid pipe		

Safety Precautions

To prevent injury to the user or other people and property damage, the following instructions must be followed.

- Be sure to read before installing the air conditioner.
- Be sure to observe the cautions specified here as they include important items related to safety.
- Incorrect operation due to ignoring instruction will cause harm or damage. The seriousness is classified by the following indications.

⚠ WARNING This symbol indicates the possibility of death or serious injury.

⚠ CAUTION This symbol indicates the possibility of injury or damage to properties only.

■ Meanings of symbols used in this manual are as shown below.

	Be sure not to do.
	Be sure to follow the instruction.

⚠ WARNING

■ Installation

Do not use a defective or under-rated circuit breaker. Use this appliance on a dedicated circuit.

- There is risk of fire or electric shock.

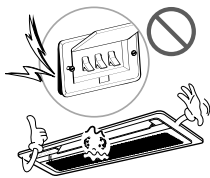

For electrical work, contact the dealer, seller, a qualified electrician, or an Authorized Service Center.

- Do not disassemble or repair the product. There is risk of fire or electric shock.



Always ground the product.

- There is risk of fire or electric shock.

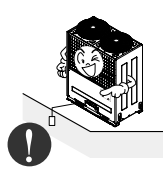

Install the panel and the cover of control box securely.

- There is risk of fire or electric shock.



Always install a dedicated circuit and breaker.

- Improper wiring or installation may cause fire or electric shock.



Use the correctly rated breaker or fuse.

- There is risk of fire or electric shock.

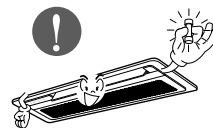

ENGLISH

Safety Precautions

Do not modify or extend the power cable.

- There is risk of fire or electric shock.

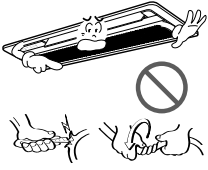

Do not let the air conditioner run for a long time when the humidity is very high and a door or a window is left open.

- Moisture may condense and wet or damage furniture.



Be cautious when unpacking and installing the product.

- Sharp edges could cause injury. Be especially careful of the case edges and the fins on the condenser and evaporator.



For installation, always contact the dealer or an Authorized Service Center.

- There is risk of fire, electric shock, explosion, or injury.



Do not install the product on a defective installation stand.

- It may cause injury, accident, or damage to the product.



Be sure the installation area does not deteriorate with age.

- If the base collapses, the air conditioner could fall with it, causing property damage, product failure, and personal injury.

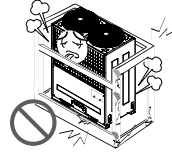

■ Operation

Do not store or use flammable gas or combustibles near the product.

- There is risk of fire or failure of product.

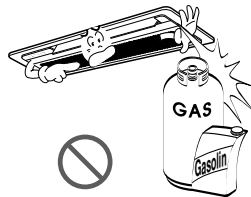

CAUTION

Installation

Always check for gas (refrigerant) leakage after installation or repair of product.

- Low refrigerant levels may cause failure of product.

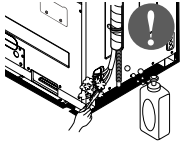

Install the drain hose to ensure that water is drained away properly.

- A bad connection may cause water leakage.

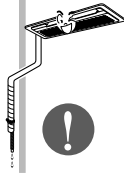

Keep level even when installing the product.

- To avoid vibration or water leakage.

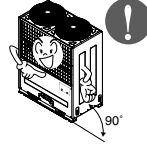

Do not install the product where the noise or hot air from the outdoor unit could damage the neighborhoods.

- It may cause a problem for your neighbors.



Use two or more people to lift and transport the product.

- Avoid personal injury.



Do not install the product where it will be exposed to sea wind (salt spray) directly.

- It may cause corrosion on the product. Corrosion, particularly on the condenser and evaporator fins, could cause product malfunction or inefficient operation.

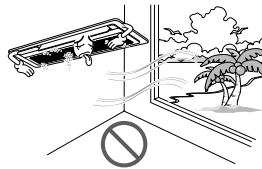

If you eat the liquid from the batteries, brush your teeth and see doctor. Do not use the remote if the batteries have leaked.

- The chemicals in batteries could cause burns or other health hazards.



ENGLISH

Installation

Read completely, then follow step by step.

Selection of the best location

- There should not be any heat source or steam near the unit.
- There should not be any obstacles to the air circulation.
- A place where air circulation in the room will be good.
- A place where drainage can be easily obtained.
- A place where noise prevention is taken into consideration.
- Do not install the unit near the door way.
- Ensure the spaces indicated by arrows from the wall, ceiling, or other obstacles.
- The indoor unit must have the maintenance space.

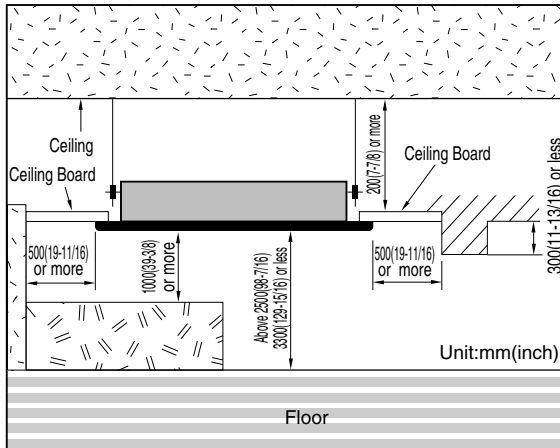

CAUTION : In case that the unit is installed near the sea, the installation parts may be corroded by salt. The installation parts (and the unit) should be taken appropriate anti-corrosion measures.

Ceiling dimension and hanging bolt location

- The dimensions of the paper model for installation are the same as those of the ceiling opening dimensions.

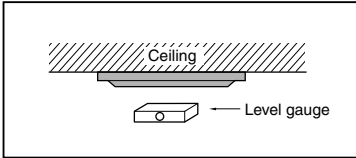

CAUTION :

- This air-conditioner uses a drain pump.
- Install the unit horizontally using a level gauge.
- During the installation, care should be taken not to damage electric wires.

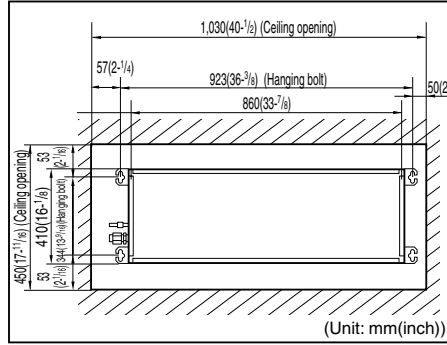

ENGLISH

- Select and mark the position for fixing bolts and piping hole.
- Decide the position for fixing bolts slightly tilted to the drain direction after considering the direction of drain hose.
- Drill the hole for anchor bolt on the wall.

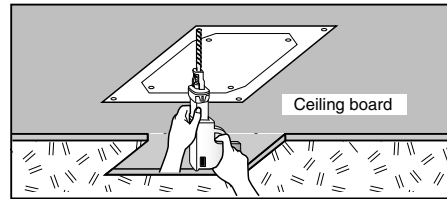

NOTICE

- Avoid the following installation location.
 - Such places as restaurants and kitchen where considerable amount of oil steam and flour is generated. These may cause heat exchange efficiency reduction, or water drops, drain pump mal-function. In these cases, take the following actions;
 - Make sure that ventilation fan is enough to cover all noxious gases from this place.
 - Ensure enough distance from the cooking room to install the air conditioner in such a place where it may not suck oily steam.
 - Avoid installing air conditioner in such places where cooking oil or iron powder is generated.
 - Avoid places where inflammable gas is generated.
 - Avoid place where noxious gas is generated.
 - Avoid places near high frequency generators.

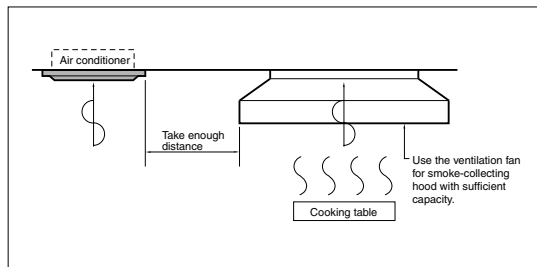

Installation

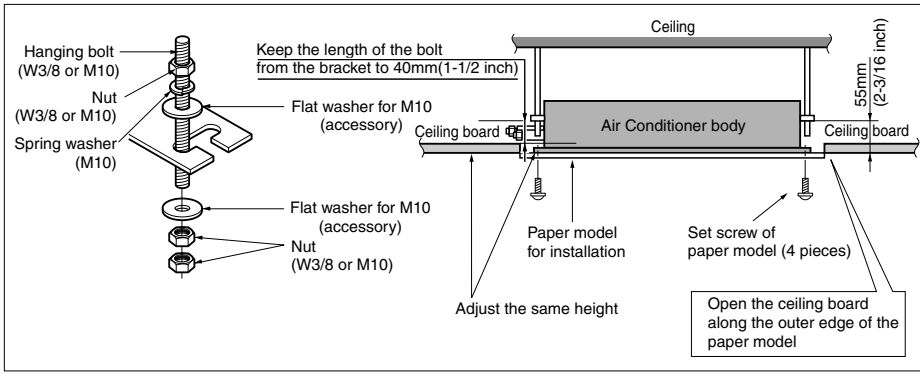

• The following parts are local purchasing.

- ① Hanging Bolt - W 3/8 or M10
- ② Nut - W 3/8 or M10
- ③ Spring Washer - M10
- ④ Plate Washer - M10

CAUTION : Tighten the nut and bolt to prevent unit from falling off.

Wiring Connection

- Connect the wires to the terminals on the control board individually according to the outdoor unit connection.
- Ensure that the color of the wires of outdoor unit and the terminal No. are the same as those of indoor unit respectively.

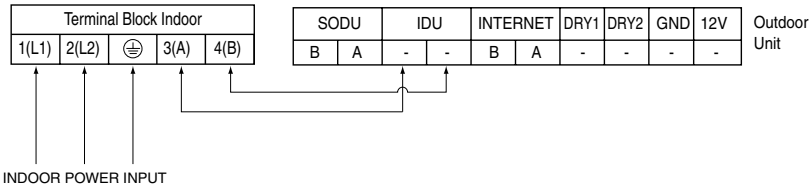

Connection method of the connecting cable(Example)

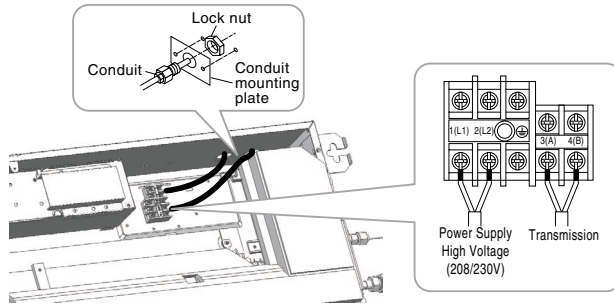

WARNING : Loose wiring may cause the terminal to overheat or result in unit malfunction. A fire hazard may also exist. Therefore, be sure all wiring is tightly connected.

WARNING : Make sure that the screws of the terminal are free from looseness.

Installation of Decoration Panel

The decoration panel has its installation direction.

Before installing the decoration panel, always remove the paper template.

1. Temporarily fix two decoration panel fixing screws (hexagon M5 screw) on the unit body. (Tighten by amount 10mm in length.)
The fixing screws (hexagon M5 screw) are included the indoor unit box.
2. Remove the air inlet grille from the decoration panel. (Remove the hook for the air inlet grille cord.)
3. Hook the decoration panel key hole () on the screws fixed in step above, and slide the panel so that the screws reach the key hole edge.
4. Retighten completely two temporarily fixed screws and other two screws. (Total 4 screws)
5. Connect the louver motor connector and display connector.
6. After tightening these screws, install the air inlet grille (including the air filter).

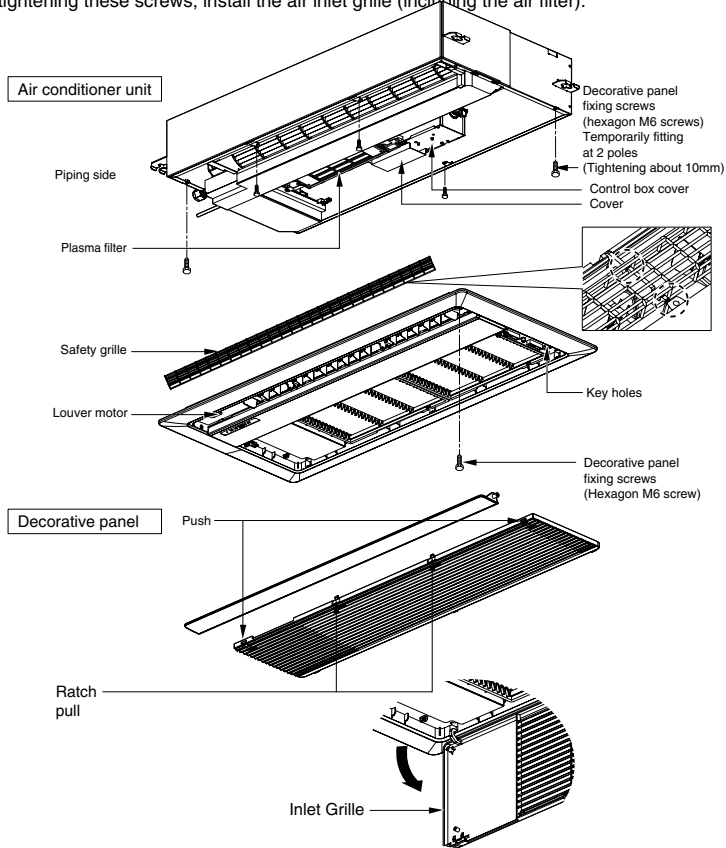

ENGLISH



CAUTION : Install certainly the decoration panel. Cool air leakage causes sweating. Water drops fall.

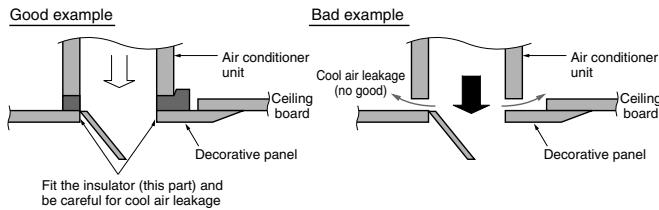

Drain Piping

- Drain piping must have down-slope (1/50 to 1/100); be sure not to provide up-and-down slope to prevent reversal flow.
- During drain piping connection, be careful not to exert extra force on the drain port on the indoor unit.
- The outside diameter of the drain connection on the indoor unit is 32mm(1-1/4 inch).

Piping material: Polyvinyl chloride pipe 25mm(1 inch) and pipe fittings

- Be sure to install heat insulation on the drain piping.

Heat insulation material: Polyethylene foam with thickness more than 8mm(5/16 inch).

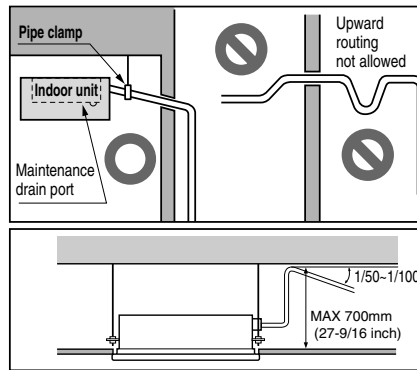

Drain test

The air conditioner uses a drain pump to drain water. Use the following procedure to test the drain pump operation:

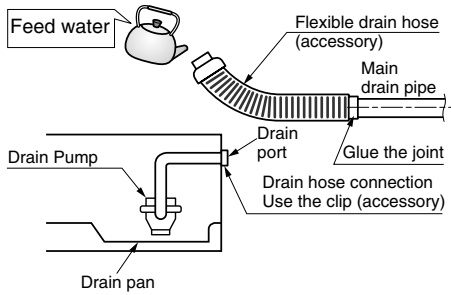

- Connect the main drain pipe to the exterior and leave it provisionally until the test comes to an end.
- Feed water to the flexible drain hose and check the piping for leakage.
- Be sure to check the drain pump for normal operating and noise when electrical wiring is complete.
- When the test is complete, connect the flexible drain hose to the drain port on the indoor unit.

CAUTION : The supplied flexible drain hose should not be curved, neither screwed. The curved or screwed hose may cause a leakage of water.

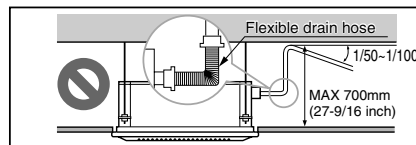



CAUTION:

After the confirmation of the above conditions, prepare the wiring as follows:

- 1) Never fail to have an individual power specialized for the air conditioner. As for the method of wiring, be guided by the circuit diagram posted on the inside of control box cover.
- 2) Provide a circuit breaker switch between power source and the unit.
- 3) The screws which fasten the wiring in the casing of electrical fittings are liable to come loose from vibrations to which the unit is subjected during the course of transportation. Check them and make sure that they are all tightly fastened. (If they are loose, it could give rise to burn-out of the wires.)
- 4) Specification of power source
- 5) Confirm that electrical capacity is sufficient.
- 6) Be sure that the starting voltage is maintained at more than 90 percent of the rated voltage marked on the name plate.
- 7) Confirm that the cable thickness is as specified in the power sources specification. (Particularly note the relation between cable length and thickness.)
- 8) Never fail to equip a leakage breaker where it is wet or moist.
- 9) The following troubles would be caused by voltage drop-down.
 - Vibration of a magnetic switch, damage on the contact point, fuse breaking, disturbance by the normal function of an overload protection device.
 - Proper starting power is not given to the compressor.

ENGLISH

HAND OVER

Teach the customer the operation and maintenance procedures, using the operation manual. (air filter cleaning, temperature control, etc.)

Installation of Wired Remote Controller

1. Connect the wired remote controller cable to the wired remote controller installation board as shown in the right picture.

12V	Red wire
SIG	Yellow wire
GND	Black wire

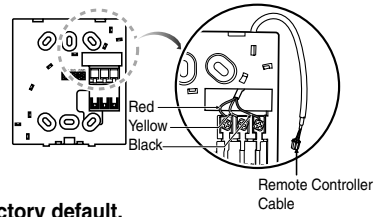

* The wired remote controller cable is connected as factory default.

2. After fixing the cable to the guide slot, attach the wired remote controller installation board at the desired location.

- Before fixing the wired remote controller cable to the guide slot, remove any clogged part of the case in the direction to install before the installation.

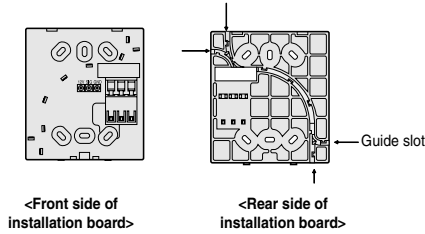

3. After locating the wired remote controller installation board at the desired location, screw the unit firmly. (When there is a buried box, install the wired remote controller board to fit the buried box.)

- Use the screw provided.

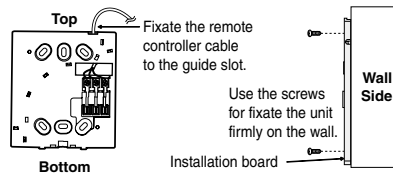

4. After fixing the top part of the wired remote controller to the installation board as shown in beside picture, press the bottom part to assemble the controller to its board.

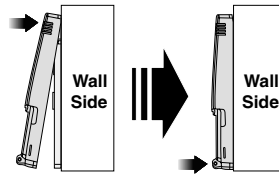

When disassemble the wired remote controller from the installation board, use the driver as shown in the right picture and insert it into the hole with the arrow. And when you pull the driver in the front direction, the wired remote controller will be separated.

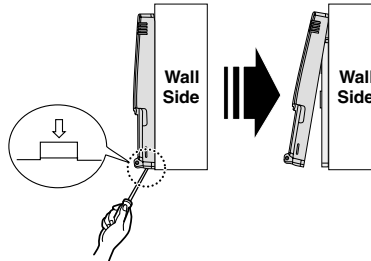

5. Use the connecting cable to connect the indoor unit and the wired remote controller.

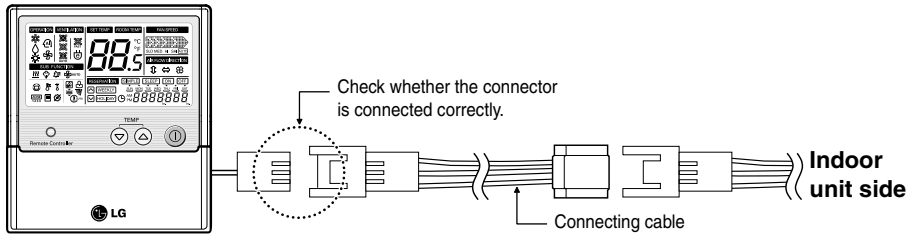

6. When the distance between the wired remote controller and the indoor unit is 10m and above, use the extension cable.

CAUTION

When installing the wired remote controller, do not bury it in the wall.
(It can cause damage in the temperature sensor.)

Do not install the cable to be 50m or above.

(It can cause communication error.)



- When installing the extension cable, check the connecting direction of the connector of the remote controller side and the product side for correct installation.
- If you install the extension cable in the opposite direction, the connector will not be connected.
- Specification of extension cable: 2547 1007 22# 2 core 3 shield 5 or above.

ENGLISH

Optional Operation of Wired Remote Controller

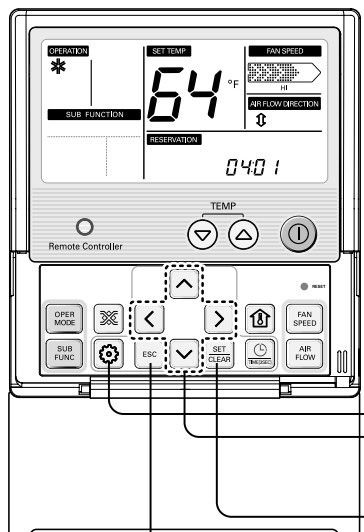







Two Thermistor System



1. Press  button for 4 seconds to enter the installer setting mode until timer segment display "01:01". 
2. Repeat pressing  button to select Function code 04.

04:01

↓ ↓

Function Code Thermistor setting
3. Set Thermistor mode by pressing   button (01: Remote Controller, 02: Indoor, 03: 2TH)  
4. Press  button to save or release 
5. Press  button to exit or system will automatically exit after 25 seconds without any input. 

* Therefore system will use value that sensed from indoor unit or remote controller

Temperature sensor location		Function
01	Remote controller	Operation in remote controller Temperature sensor
02	Indoor unit	Operation in indoor unit temperature sensor
03	2-Thermistor	Operation in lower temperature after comparing the temperature between the indoor unit and remote controller

* If you want to know more Optional Operation, please refer to Wired Remote Controller Manual.



P/No.: MFL42803113

Printed in Korea

After reading this manual, keep it in a place easily accessible to the user for future reference.