

This Owner's Manual is provided and hosted by [Appliance Factory Parts](#).



# LG ARNU243B4G2 Owner's Manual

[Shop genuine replacement parts for LG ARNU243B4G2](#)



[Find Your LG HVAC Parts - Select From 245 Models](#)

----- Manual continues below part list -----

## Available Replacement Parts for LG ARNU243B4G2

[EBG61325804](#)

Ntc Thermistor Assembly



ENGLISH

FRANÇAIS

ESPAÑOL

# OWNER'S MANUAL AIR CONDITIONER

Please read this manual carefully before operating your set and retain it for future reference.

TYPE : Built - in Duct - Low Static

# TABLE OF CONTENTS

**Safety Precautions**.....3  
**Prior to Operation** .....8  
**Operating Instructions**.....9  
    *Name and Function of Remote Controller*.....9  
**Maintenance and Service** ....11  
    *Before you Call for Service*..... 13



## FOR YOUR RECORDS

Write the model and serial numbers here:

**Model #** \_\_\_\_\_

**Serial #** \_\_\_\_\_

You can find them on a label on the side of each unit.

**Dealer's Name** \_\_\_\_\_

**Date Purchased** \_\_\_\_\_

■ Staple your receipt to this page in the event you need to prove date of purchase or to issue warranty.



## READ THIS MANUAL

Inside you will find many helpful hints on how to use and maintain your air conditioner properly. Just a little preventive care on your part can save you a great deal of time and money over the life of your air conditioner.

You'll find many answers to common problems in the chart of troubleshooting tips. If you review our chart of

**Troubleshooting Tips** first, you may not need to call for service at all.



## PRECAUTION

- Contact the authorized service technician for repair or maintenance of this unit.
- Contact the installer for installation of this unit.
- The air conditioner is not intended for use by young children or invalids without supervision.
- Young children should be supervised to ensure that they do not play with the air conditioner.
- When the power cord is to be replaced, replacement work shall be performed by authorized personnel only using only genuine replacement parts.
- Installation work must be performed in accordance with the National Electric Code by qualified and authorized personnel only.

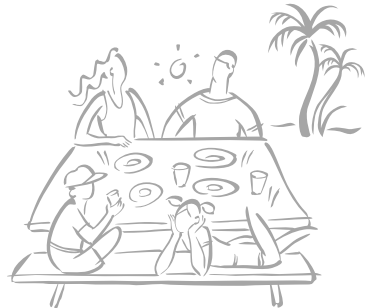

# Safety Precautions

To prevent injury to the user or other people and property damage, the following instructions must be followed.

■ Incorrect operation due to ignoring instruction will cause harm or damage. The seriousness is classified by the following indications.

**⚠ WARNING** This symbol indicates the possibility of death or serious injury.

**⚠ CAUTION** This symbol indicates the possibility of injury or damage to properties only.

■ Meanings of symbols used in this manual are as shown below.

	<b>Be sure not to do.</b>
	<b>Be sure to follow the instruction.</b>

## ⚠ WARNING

### ■ Installation

**Do not use a defective or underrated circuit breaker. Use this appliance on a dedicated circuit.**

- There is risk of fire or electric shock.

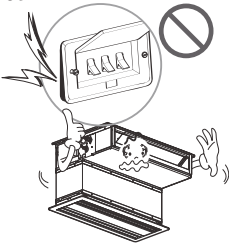

**For electrical work, contact the dealer, seller, a qualified electrician, or an Authorized Service Center.**

- Do not disassemble or repair the product. There is risk of fire or electric shock.

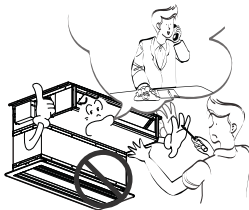

**Always ground the product.**

- There is risk of fire or electric shock.

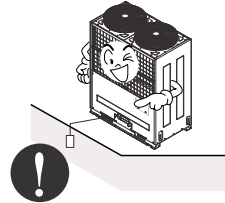

**Install the panel and the cover of control box securely.**

- There is risk of fire or electric shock.

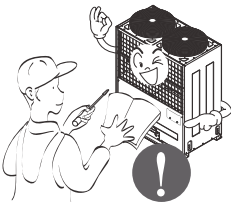

**Always install a dedicated circuit and breaker.**

- Improper wiring or installation may cause fire or electric shock



**Use the correctly rated breaker or fuse.**

- There is risk of fire or electric shock.

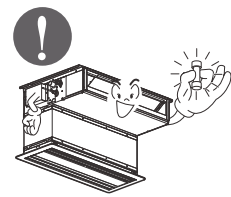

**Do not modify or extend the power cable.**

- There is risk of fire or electric shock.

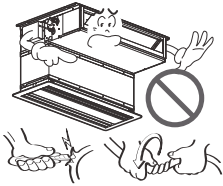

**Do not install, remove, or re-install the unit by yourself (customer).**

- There is risk of fire, electric shock, explosion, or injury.



**Be cautious when unpacking and installing the product.**

- Sharp edges could cause injury. Be especially careful of the case edges and the fins on the condenser and evaporator.



**For installation, always contact the dealer or an Authorized Service Center.**

- There is risk of fire, electric shock, explosion, or injury.

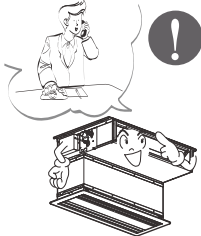

**Do not install the product on a defective installation stand.**

- It may cause injury, accident, or damage to the product.



**Be sure the installation area does not deteriorate with age.**

- If the base collapses, the air conditioner could fall with it, causing property damage, product failure, and personal injury.

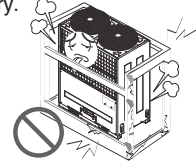

**■ Operation**

**Do not let the air conditioner run for a long time when the humidity is very high and a door or a window is left open.**

- Moisture may condense and wet or damage furniture.



**Take care to ensure that power cable could not be pulled out or damaged during operation.**

- There is risk of fire or electric shock.

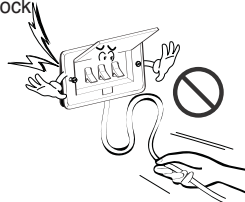

**Do not place anything on the power cable.**

- There is risk of fire or electric shock.

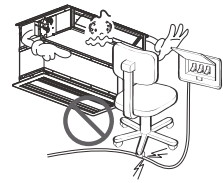

**Do not plug or unplug the power supply plug during operation.**

- There is risk of fire or electric shock.

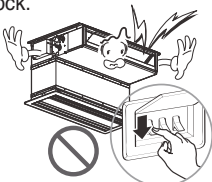

**Do not touch(operate) the product with wet hands.**

- There is risk of fire or electrical shock.



**Do not place a heater or other appliances near the power cable.**

- There is risk of fire and electric shock.

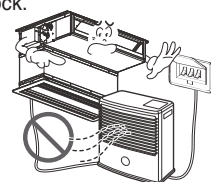

**Do not allow water to run into electric parts.**

- It may cause There is risk of fire, failure of the product, or electric shock.

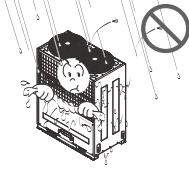

**Do not store or use flammable gas or combustibles near the product.**

- There is risk of fire or failure of product.

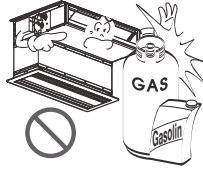

**Do not use the product in a tightly closed space for a long time.**

- Oxygen deficiency could occur.

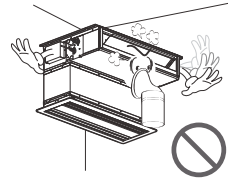

**When flammable gas leaks, turn off the gas and open a window for ventilation before turn the product on.**

- Do not use the telephone or turn switches on or off. There is risk of explosion or fire

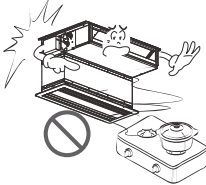

**If strange sounds, or small or smoke comes from product. Turn the breaker off or disconnect the power supply cable.**

- There is risk of electric shock or fire.



**Stop operation and close the window in storm or hurricane. If possible, remove the product from the window before the hurricane arrives.**

- There is risk of property damage, failure of product, or electric shock.

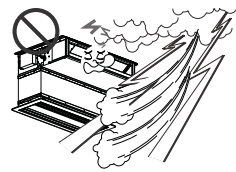

**Do not open the inlet grill of the product during operation. (Do not touch the electrostatic filter, if the unit is so equipped.)**

- There is risk of physical injury, electric shock, or product failure.

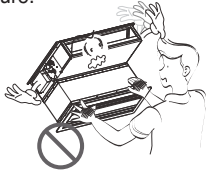

**When the product is soaked (flooded or submerged), contact an Authorized Service Center.**

- There is risk of fire or electric shock.



**Be cautious that water could not enter the product.**

- There is risk of fire, electric shock, or product damage.

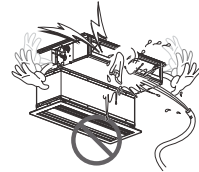

**Ventilate the product from time to time when operating it together with a stove, etc.**

- There is risk of fire or electric shock.

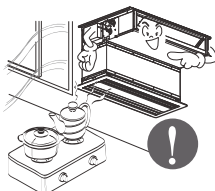

**Turn the main power off when cleaning or maintaining the product.**

- There is risk of electric shock.

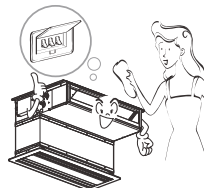

When the product is not be used for a long time, disconnect the power supply plug or turn off the breaker.

- There is risk of product damage or failure, or unintended operation.

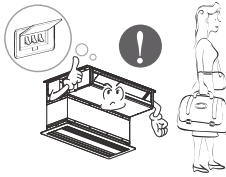

Take care to ensure that nobody could step on or fall onto the outdoor unit.

- This could result in personal injury and product damage.

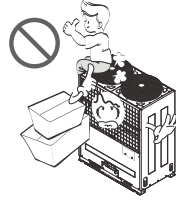

## CAUTION

### Installation

Always check for gas (refrigerant) leakage after installation or repair of product.

- Low refrigerant levels may cause failure of product.



Install the drain hose to ensure that water is drained away properly.

- A bad connection may cause water leakage.

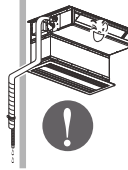

Keep level even when installing the product.

- To avoid vibration or water leakage.

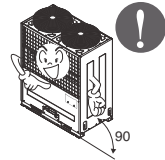

Do not install the product where the noise or hot air from the outdoor unit could damage the neighborhoods.

- It may cause a problem for your neighbors.



Use two or more people to lift and transport the product.

- Avoid personal injury.



Do not install the product where it will be exposed to sea wind (salt spray) directly.

- It may cause corrosion on the product. Corrosion, particularly on the condenser and evaporator fins, could cause product malfunction or inefficient operation.

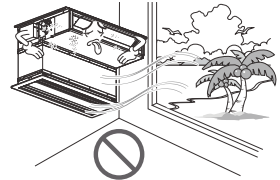

### Operation

Do not expose the skin directly to cool air for long periods of time. (Don't sit in the draft.)

- This could harm to your health.

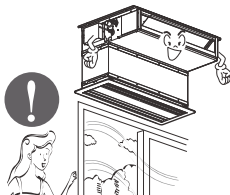

Do not use the product for special purposes, such as preserving foods, works of art, etc. It is a consumer air conditioner, not a precision refrigeration system.

- There is risk of damage or loss of property.

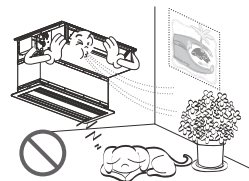

**Do not block the inlet or outlet of air flow.**

- It may cause product failure.

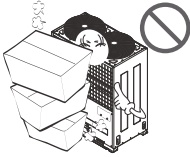

**Use a soft cloth to clean. Do not use harsh detergents, solvents, etc.**

- There is risk of fire, electric shock, or damage to the plastic parts of the product.

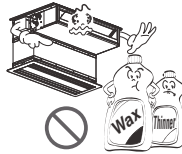

**Do not touch the metal parts of the product when removing the air filter. They are very sharp!**

- There is risk of personal injury.

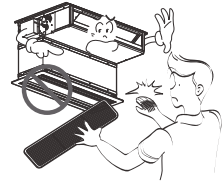

**Do not step on or put anything on the product. (outdoor units)**

- There is risk of personal injury and failure of product.



**Always insert the filter securely. Clean the filter every two weeks or more often if necessary.**

- A dirty filter reduces the efficiency of the air conditioner and could cause product malfunction or damage.

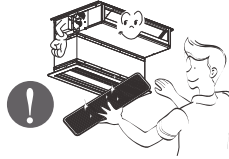

**Do not insert hands or other objects through the air inlet or outlet while the product is operated.**

- There are sharp and moving parts that could cause personal injury.

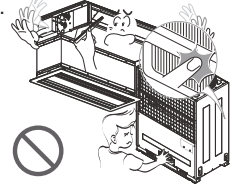

**Do not drink the water drained from the product.**

- It is not sanitary and could cause serious health issues.

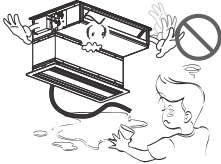

**Use a firm stool or ladder when cleaning or maintaining the product.**

- Be careful and avoid personal injury.



**Replace the all batteries in the remote control with new ones of the same type. Do not mix old and new batteries or different types of batteries.**

- There is risk of fire or explosion

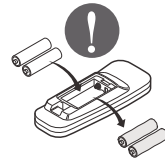

**Do not recharge or disassemble the batteries. Do not dispose of batteries in a fire.**

- They may burn or explode.



**If the liquid from the batteries gets onto your skin or clothes, wash it well with clean water. Do not use the remote if the batteries have leaked.**

- The chemicals in batteries could cause burns or other health hazards.



**If you eat the liquid from the batteries, brush your teeth and see doctor. Do not use the remote if the batteries have leaked.**

- The chemicals in batteries could cause burns or other health hazards.



## Prior to Operation

### *Preparing for operation*

1. Contact an installation specialist for installation.
2. Use a dedicated circuit.

### *Usage*

1. Being exposed to direct airflow for an extended period of time could be hazardous to your health. Do not expose occupants, pets, or plants to direct airflow for extended periods of time.
2. Due to the possibility of oxygen deficiency, ventilate the room when used together with stoves or other heating devices.
3. Do not use this air conditioner for non-specified special purposes (e.g. preserving precision devices, food, pets, plants, and art objects). Such usage could damage the items.

### *Cleaning and maintenance*

1. Do not touch the metal parts of the unit when removing the filter. Injuries can occur when handling sharp metal edges.
2. Do not use water to clean inside the air conditioner. Exposure to water can destroy the insulation, leading to possible electric shock.
3. When cleaning the unit, first make sure that the power and breaker are turned off. The fan rotates at a very high speed during operation. There is a possibility of injury if the unit's power is accidentally triggered on while cleaning inner parts of the unit.

### *Service*

For repair and maintenance, contact your authorized service dealer.

# Operating Instructions

## Name and function of wired remote controller(Accessory)

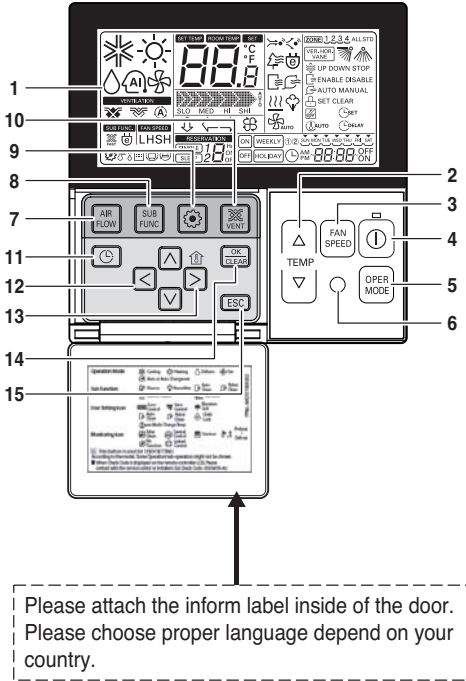

Please attach the inform label inside of the door.  
Please choose proper language depend on your country.

1. Operation indication screen
2. Set temperature button
  - It will set not room temperature but outlet air temperature.
3. Fan speed button
  - Fan Speed have 3 Steps.
  - Middle and Low step is same
4. ON/OFF button
5. Operation mode selection button
6. Wireless remote controller receiver
  - Some products don't receive the wireless signals.
7. Air flow button
8. Subfunction button
9. Function setting button
10. Ventilation button
11. Reservation
12. Up,down,left,right button
  - To check the indoor temperature, press  button.
13. Room temperature button
  - Displays only the room temperature of the remote controller perception.
  - There is no control of room temperature.
  - In case of fresh air intake unit, displays only the temperature around remote controller.
14. Setting/Cancel button
15. Exit button

※ Some functions may not be operated and displayed depending on the product type.

※ It will display strange value to the room temperature if wired remote controller is not connected.

**Model : PQRCVSL0 (Black Color)**  
**PQRCVSL0QW (White Color)**

## Name and function of wired remote controller(Optional)

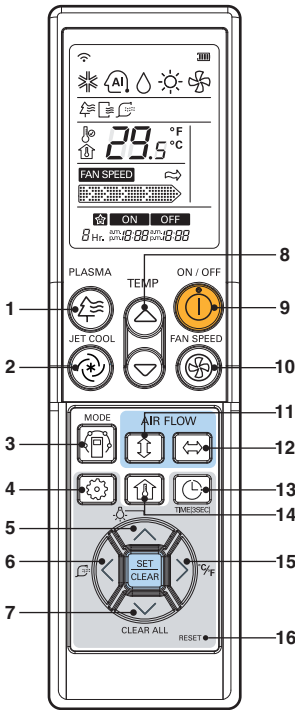

**PQWRCDF0 (Heat pump)**  
**PQWRHDF0 (Cooling only)**

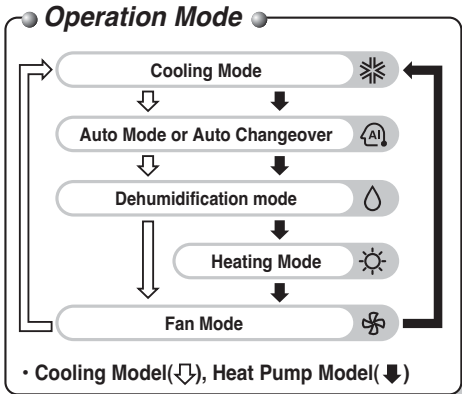

- 1. Plasma button (optional)**  
Used to start or stop the plasma-purification function.
- 2. Jet cool button**  
Speed cooling operates super high fan speed.
- 3. Operation mode selection button**  
Used to select the operation mode.
- 4. Function setting button**  
Used to set or clear auto clean or smart clean.
- 5. LCD luminosity button (optional)**  
Used to adjust LCD luminosity
- 6. Smart clean button (optional)**  
Used to start or stop smart clean.
- 7. Clear all button**  
Used to clear all timer.
- 8. Room temperature setting button**  
Used to select the room temperature.
- 8. ON/OFF button**  
Used to turn off/on the unit.
- 10. Indoor fan speed selection button**  
Used to select fan speed in four steps low, medium, high and chaos.
- 11. Auto swing button**  
Used to stop or start louver movement and set the desired up/down airflow direction.
- 12. Horizontal airflow direction control button (optional)**  
Used to set the desired horizontal airflow direction.
- 13. Timer and time setting button**  
Used to set the time of starting or stopping and sleeping operation.
- 14. Room temperature checking button**  
Used to check the room temperature.
- 15. °C/F switch button**  
Used to switch temperature reading from celsius to fahrenheit.
- 16. Reset button**  
Used to reset the remote controller.

# Maintenance and Service



**CAUTION:** Before performing any maintenance, turn off the main power to the system.

## Grille, Case, and Remote Control

- Turn the system off before cleaning. To clean, wipe with a soft, dry cloth. Do not use bleach or abrasives.

### **NOTICE**

Supply power must be disconnected before cleaning the indoor unit.

## Air Filter

The air filters behind Indoor unit (the suction side) should be checked and cleaned once every 2 weeks or more often if necessary.

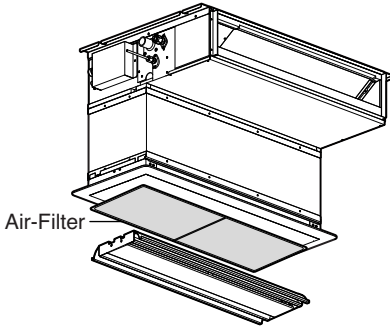

- Never use any of the followings:

- Water hotter than 40°C  
Could cause deformation and/or discoloration.
- Volatile substances  
Could damage the surfaces of the air conditioner.



1. Clean the filter with a vacuum or warm, soapy water.
  - If very dirty, wash with a solution of detergent in lukewarm water.
  - If hot water (50°C or more) is used, filter may be deformed.
2. After washing with water, dry well in the shade.
3. Re-install the air filter.

## When the air conditioner is not going to be used for a long time.

When it is not going to be used for a long time.

**1** Operate the air conditioner on Air circulation mode for 2 to 3 hours.

- This will dry out the internal parts.

**2** Turn off the circuit breaker.



### CAUTION

Turn off the circuit breaker when the air conditioner is not going to be used for a long time. Dirt may collect and may cause a fire.

When the air conditioner is to be used again.

■ Check that the air inlet and outlet of the indoor/outdoor unit are not blocked.

### Helpful information

The air filters and your electric bill. If the air filters become clogged with dust, the cooling capacity will drop, and 6% of the electricity used to operate the air conditioner will be wasted.

## Operation Tips

Do not overcool the room.

This is not good for the health and wastes electricity.

Clean the air filter regularly.

Blockages in the air filter reduce the airflow and lower cooling and dehumidifying effects. Clean at least once every two weeks.

Keep blinds or curtains closed.

Do not let direct sunshine enter the room when the air conditioner is in operation.

Ventilate the room occasionally.

Since windows are kept closed, it is a good idea to open them and ventilate the room now and then.

Make sure that the doors and windows are shut tight.

Avoid opening doors and windows as much as possible to keep the cool air in the room.

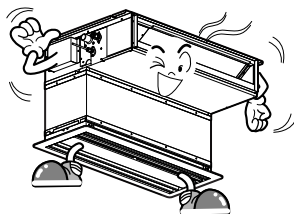

**Before you call for service...**



**Troubleshooting Tips! Save time and money!**

Check the following points before requesting repairs or service.... If the malfunction persists, please contact your dealer.

<p><b>The air conditioner does not operate.</b></p> <ul style="list-style-type: none"> <li>• Have you made a mistake in timer operation?</li> <li>• Has the fuse blown or has the circuit breaker been tripped?</li> </ul>	<p><b>The room has a peculiar odor.</b></p> <ul style="list-style-type: none"> <li>• Check that this is not a damp smell exuded by the walls, carpet, furniture or cloth items in the room.</li> </ul>	<p><b>It seems that condensation is leaking from the air conditioner.</b></p> <ul style="list-style-type: none"> <li>• Condensation occurs when the airflow from the air conditioner cools the warm room air.</li> </ul>	<p><b>Air conditioner does not operate for about 3 minutes when restart.</b></p> <ul style="list-style-type: none"> <li>• This is the protector of the mechanism.</li> <li>• Wait about three minutes and operation will begin.</li> </ul>
<p><b>Does not cool or heat effectively.</b></p> <ul style="list-style-type: none"> <li>• Is the air filter dirty? See air filter cleaning instructions.</li> <li>• The room may have been very hot when the room air conditioner was first turned on. Allow time for it to cool down.</li> <li>• Has the temperature been set incorrectly?</li> <li>• Are the indoor unit's air inlet or outlet vents obstructed?</li> </ul>	<p><b>The air conditioner operation is noisy.</b></p> <ul style="list-style-type: none"> <li>• For a noise that sounds like water flowing.                     <ul style="list-style-type: none"> <li>-This is the sound of freon flowing inside the air conditioner unit.</li> </ul> </li> <li>• For a noise that sounds like the compressed air releasing into atmosphere.                     <ul style="list-style-type: none"> <li>-This is the sound of the dehumidifying water being processed inside the air conditioning unit.</li> </ul> </li> </ul>	<p><b>Crack sound is heard.</b></p> <ul style="list-style-type: none"> <li>• This sound is generated by the expansion/ constriction of the front panel, etc. due to changes of temperature.</li> </ul> <p><b>Filter sign lamp (LED) is ON.</b></p> <ul style="list-style-type: none"> <li>• Cleaning the filter, press the Timer button and ◀ button of wired remote controller at the same time for 3 sec.</li> </ul>	<p><b>Remote control display is faint, or no display at all.</b></p> <ul style="list-style-type: none"> <li>• Are the batteries depleted?</li> <li>• Are the batteries inserted in the opposite (+) and (-) directions?</li> </ul>

**NOTICE**

**WATER RESISTANT:** The outdoor side of this appliance is WATER RESISTANT. The indoor side is not water resistant and should not be exposed to excess water.



