

This Owner's Manual is provided and hosted by [Appliance Factory Parts](#).



# LG ARNU243B4G2 Owner's Manual

[Shop genuine replacement parts for LG ARNU243B4G2](#)



[Find Your LG HVAC Parts - Select From 50 Models](#)

----- Manual continues below -----



website <http://www.lgservice.com>

LG

# ***MULTI V***<sup>™</sup> System Indoor Unit (2 Series)

## ***INSTALLATION MANUAL***

***Type: Built - in Duct - Low Static***

ENGLISH

FRANÇAIS

ESPAÑOL

### IMPORTANT

- Please read this installation manual completely before installing the product.
- Installation work must be performed in accordance with the national wiring standards by authorized personnel only.
- Please retain this installation manual for future reference after reading it thoroughly.

## IMPORTANT!

### Please read this instruction sheet completely before installing the product.

This air conditioning system meets strict safety and operating standards. As the installer or service person, it is an important part of your job to install or service the system so it operates safely and efficiently.

#### WARNING

- Installation or repairs made by unqualified persons can result in hazards to you and others. Installation MUST conform with local building codes or, in the absence of local codes, with the National Electrical Code NFPA 70/ANSI C1-1993 or current edition and Canadian Electrical Code Part1 CSA C.22.1.
- The information contained in the manual is intended for use by a qualified service technician familiar with safety procedures and equipped with the proper tools and test instruments.
- Failure to carefully read and follow all instructions in this manual can result in equipment malfunction, property damage, personal injury and/or death.

**CAUTION:** Improper installation, adjustment, alteration, service or maintenance can void the warranty. The weight of the condensing unit requires caution and proper handling procedures when lifting or moving to avoid personal injury. Use care to avoid contact with sharp or pointed edges.

#### Safety Precautions

- Always wear safety eye wear and work gloves when installing equipment.
- Never assume electrical power is disconnected. Check with meter and equipment.
- Keep hands out of fan areas when power is connected to equipment.
- R-410A causes frostbite burns.
- R-410A is toxic when burned.

**NOTE TO INSTALLING DEALER:** The Owners Instructions and Warranty are to be given to the owner or prominently displayed near the indoor Furnace/Air Handler Unit.

#### Special warnings

##### When wiring:

**Electrical shock can cause severe personal injury or death. Only a qualified, experienced electrician should attempt to wire this system.**

- Do not supply power to the unit until all wiring and tubing are completed or reconnected and checked.
- Highly dangerous electrical voltages are used in this system. Carefully refer to the wiring diagram and these instructions when wiring. Improper connections and inadequate grounding can cause accidental injury or death.
- Ground the unit following local electrical codes.
- Connect all wiring tightly. Loose wiring may cause overheating at connection points and a possible fire hazard.

##### When transporting:

Be careful when picking up and moving the indoor and outdoor units. Get a partner to help, and bend your knees when lifting to reduce strain on your back. Sharp edges or thin aluminum fins on the air conditioner can cut your finger.

##### When installing...

- ... **in a wall:** Make sure the wall is strong enough to hold the unit's weight. It may be necessary to construct a strong wood or metal frame to provide added support.
- ... **in a room:** Properly insulate any tubing run inside a room to prevent "sweating" that can cause dripping and water damage to wall and floors.
- ... **in moist or uneven locatinons:** Use a raised concrete pad or concrete blocks provide a solid, level foundation for the outdoor unit. This prevents water damage and abnormal vibration.
- ... **in an area with high winds:** Securely anchor the outdoor unit down with bolts and a metal frame. Provide a suitable air baffle.
- ... **in a snowy area(for Heat Pump Model):** Install the outdoor unit on a raised platform that is higher than drifting snow. Provide snow vents.

##### When connecting refrigerant tubing

- Keep all tubing runs as short as possible.
- Use the flare method for connecting tubing.
- Check carefully for leaks before starting the test run.

##### When servicing

- Turn the power OFF at the main power box(mains) before opening the unit to check or repair electrical parts and wiring.
- Keep your fingers and clothing away from any moving parts.
- Clean up the site after you finish, remembering to check that no metal scraps or bits of wiring have been left inside the unit being serviced.

# TABLE OF CONTENTS

<i>Installation Requirements</i>	<i>Required Parts</i>	<i>Required Tools</i>
<b>Safety Precautions</b> .....4		
<b>Introduction</b> .....7		
<b>Installation</b>		
Selection of the best location .....8	<input type="checkbox"/> Four type "A" screws <input type="checkbox"/> Connecting cable	<input type="checkbox"/> Level gauge <input type="checkbox"/> Screw driver <input type="checkbox"/> Electric drill <input type="checkbox"/> Hole core drill
Ceiling opening dimension and hanging bolt location .....9	<input type="checkbox"/> Pipes: Gas side Liquid side (Refer to Product Data) <input type="checkbox"/> Insulation materials <input type="checkbox"/> Additional drain pipe	<input type="checkbox"/> Flaring tool set <input type="checkbox"/> Specified torque wrenches (different depending on model No.) <input type="checkbox"/> Spanner .....Half union
Indoor Unit Installation.....10		
Wiring Connection .....10		<input type="checkbox"/> A glass of water <input type="checkbox"/> Screw driver
Part name and functions .....11		<input type="checkbox"/> Hexagonal wrench <input type="checkbox"/> Gas-leak detector <input type="checkbox"/> Vacuum pump <input type="checkbox"/> Gauge manifold
Checking the Drainage.....12		
Installation of Wired Remote Controller.....16		<input type="checkbox"/> Owner's manual <input type="checkbox"/> Thermometer
Optional Operation of Wired Remote Controller ....18		
Dip Switch Setting .....19		
Group Control Setting.....20		
<b>How to Set E.S.P?</b> .....23		

ENGLISH

# Safety Precautions



To prevent injury to the user or other people and property damage, the following instructions must be followed.

- Be sure to read before installing the air conditioner.
- Be sure to observe the cautions specified here as they include important items related to safety.
- Incorrect operation due to ignoring instruction will cause harm or damage. The seriousness is classified by the following indications.

**⚠ WARNING** This symbol indicates the possibility of death or serious injury.

**⚠ CAUTION** This symbol indicates the possibility of injury or damage to properties only.

■ Meanings of symbols used in this manual are as shown below.

	<b>Be sure not to do.</b>
	<b>Be sure to follow the instruction.</b>

## ⚠ WARNING

### ■ Installation

**Do not use a defective or under-rated circuit breaker. Use this appliance on a dedicated circuit.**

- There is risk of fire or electric shock.

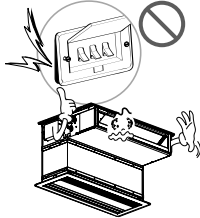

**For electrical work, contact the dealer, seller, a qualified electrician, or an Authorized Service Center.**

- Do not disassemble or repair the product. There is risk of fire or electric shock.

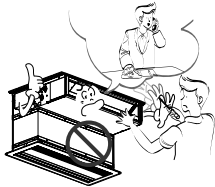

**Always ground the product.**

- There is risk of fire or electric shock.

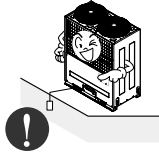

**Install the panel and the cover of control box securely.**

- There is risk of fire or electric shock.



**Always install a dedicated circuit and breaker.**

- Improper wiring or installation may cause fire or electric shock.

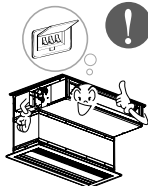

**Use the correctly rated breaker or fuse.**

- There is risk of fire or electric shock.

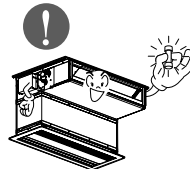

**Do not modify or extend the power cable.**

- There is risk of fire or electric shock.

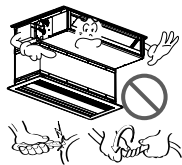

**Do not let the air conditioner run for a long time when the humidity is very high and a door or a window is left open.**

- Moisture may condense and wet or damage furniture.



**Be cautious when unpacking and installing the product.**

- Sharp edges could cause injury. Be especially careful of the case edges and the fins on the condenser and evaporator.



**For installation, always contact the dealer or an Authorized Service Center.**

- There is risk of fire, electric shock, explosion, or injury.



**Do not install the product on a defective installation stand.**

- It may cause injury, accident, or damage to the product.



**Be sure the installation area does not deteriorate with age.**

- If the base collapses, the air conditioner could fall with it, causing property damage, product failure, and personal injury.

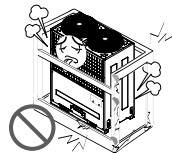

ENGLISH

## ■ Operation

**Do not store or use flammable gas or combustibles near the product.**

- There is risk of fire or failure of product.



**CAUTION**

**Installation**

**Always check for gas (refrigerant) leakage after installation or repair of product.**

- Low refrigerant levels may cause failure of product.

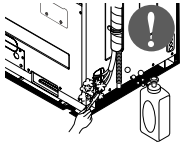

**Install the drain hose to ensure that water is drained away properly.**

- A bad connection may cause water leakage.

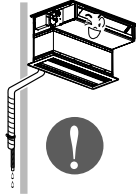

**Keep level even when installing the product.**

- To avoid vibration or water leakage.

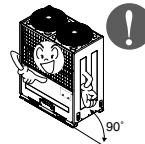

**Do not install the product where the noise or hot air from the outdoor unit could damage the neighborhoods.**

- It may cause a problem for your neighbors.



**Use two or more people to lift and transport the product.**

- Avoid personal injury.



**Do not install the product where it will be exposed to sea wind (salt spray) directly.**

- It may cause corrosion on the product. Corrosion, particularly on the condenser and evaporator fins, could cause product malfunction or inefficient operation.

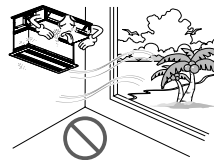

**If you eat the liquid from the batteries, brush your teeth and see doctor. Do not use the remote if the batteries have leaked.**

- The chemicals in batteries could cause burns or other health hazards.



# Introduction

## Symbols Used in this Manual



This symbol alerts you to the risk of electric shock.



This symbol alerts you to hazards that could cause harm to the air conditioner.

**NOTICE**

This symbol indicates special notes.

## Features

### Built-in Duct type

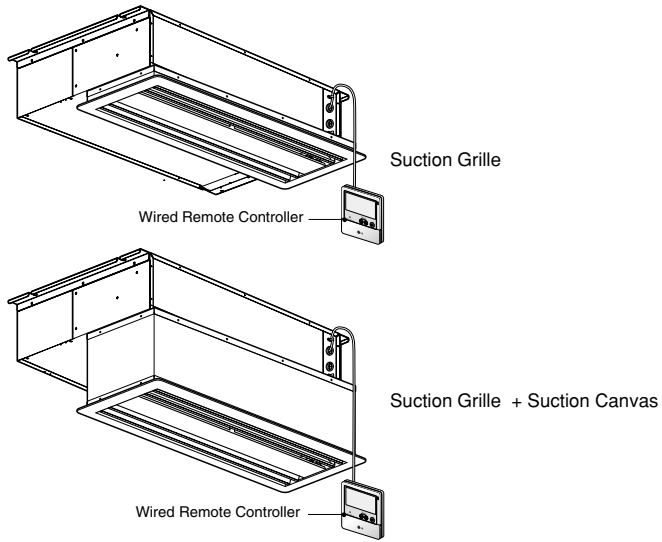

ENGLISH

# Installation

## Selection of the best location

### Indoor unit

Install the air conditioner in the location that satisfies the following conditions.

- The place shall easily bear a load exceeding four times the indoor unit's weight.
- The place shall be able to inspect the unit as the figure.
- The place where the unit shall be leveled.
- The place shall easily connect with the outdoor unit.
- The place where the unit is not affected by an electrical noise.
- The place where air circulation in the room will be good .
- There should not be any heat source or steam near the unit

Confirm the positional relationship between the unit and suspension bolts.

- Installation the ceiling opening to clean the filter or service under the product.

[Unit: mm(inch)]

Chassis	A	B
B3	600(23-5/8)	900(35-7/16)
B4	600(23-5/8)	1100(43-5/16)

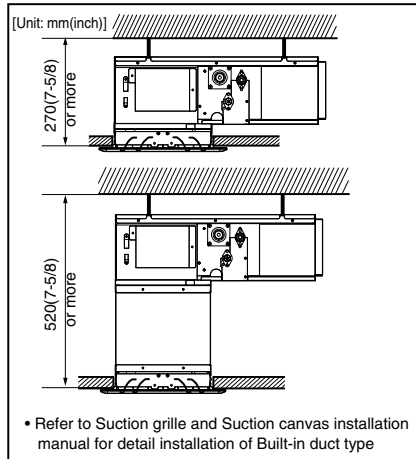
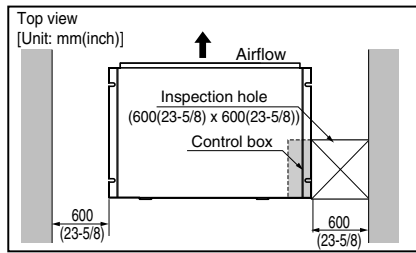
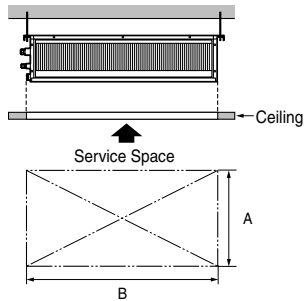
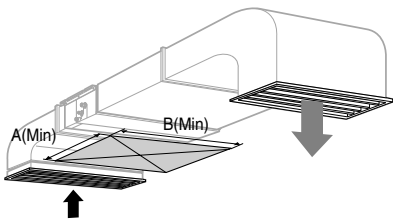

### Built-in Duct type

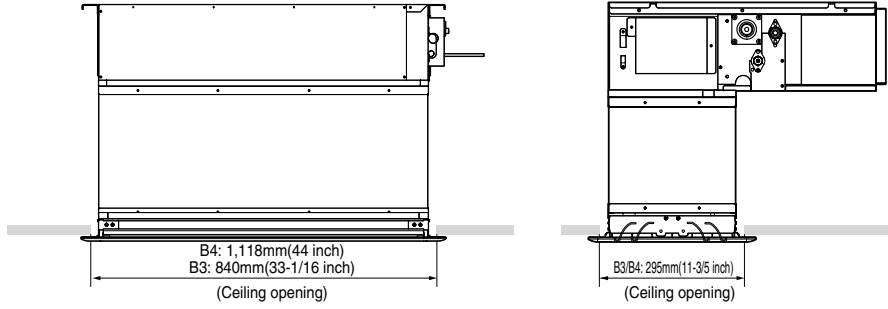

**Ceiling dimension and hanging bolt location**

**Installation of Unit**

Install the unit above the ceiling correctly.

**CASE 1**

**POSITION OF SUSPENSION BOLT**

- Apply a joint-canvas between the unit and duct to absorb unnecessary vibration.
- Apply a filter Accessory at air return hole.

[Unit: mm(inch)]

Dimension	A	B	C	D	E	F	G	H	I	J
Chassis										
B3	850 (33-7/16)	900 (35-7/16)	383 (383/16)	575 (22-5/8)	93 (3-11/16)	190 (7-7/16)	21 (7/8)	795 (31-5/16)	163 (6-7/16)	820 (32-5/16)
B4	1130 (44-7/16)	1180 (46-7/16)	383 (383/16)	575 (22-5/8)	93 (3-11/16)	190 (7-7/16)	21 (7/8)	1065 (41-9/16)	163 (6-7/16)	1100 (43-3/16)

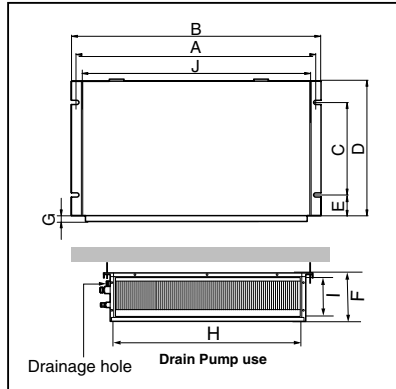

ENGLISH

**CASE 2**

- Install the unit leaning to a drainage hole side as a figure for easy water drainage.

**POSITION OF CONSOLE BOLT**

- A place where the unit will be leveled and that can support the weight of the unit.
- A place where the unit can withstand its vibration.
- A place where service can be easily performed.

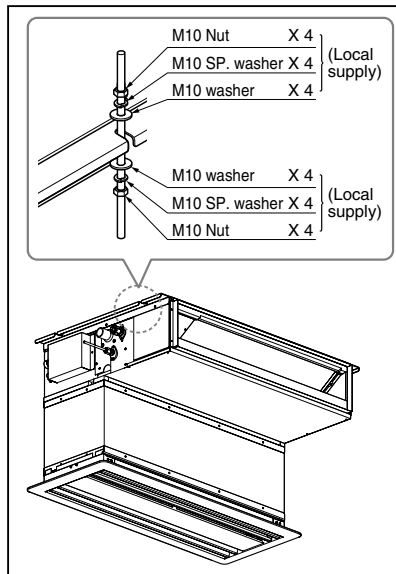

## Indoor Unit Installation

- Select and mark the position for fixing bolts.
- Drill the hole for set anchor on the face of ceiling.

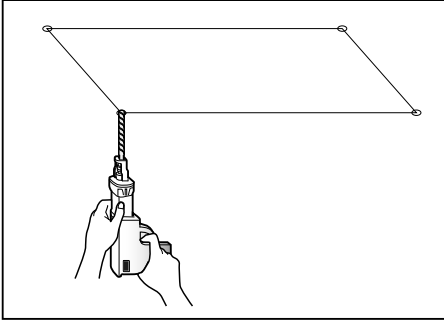

- Insert the set anchor and washer onto the suspension bolts for locking the suspension bolts on the ceiling.
- Mount the suspension bolts to the set anchor firmly.
- Secure the installation plates onto the suspension bolts (adjust level roughly) using nuts, washers and spring washers.

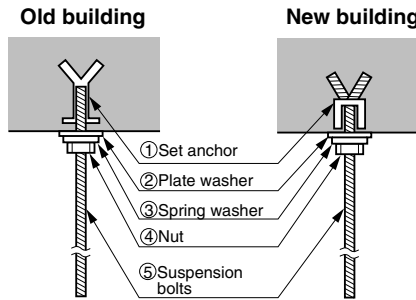

**CAUTION :** Tighten the nut and bolt to prevent unit falling.

## Wiring Connection

- Connect the wires to the terminals on the control board individually according to the outdoor unit connection.
- Ensure that the color of the wires of outdoor unit and the terminal No. are the same as those of indoor unit respectively.

### B3/B4 Series

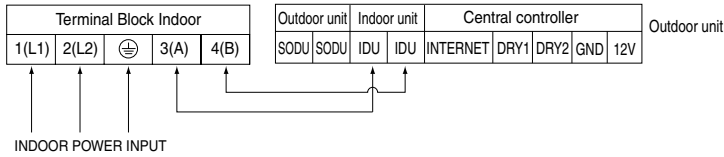

**WARNING :** Make sure that the screws of the terminal are free from looseness.

### Connection method of the connecting cable(Example)

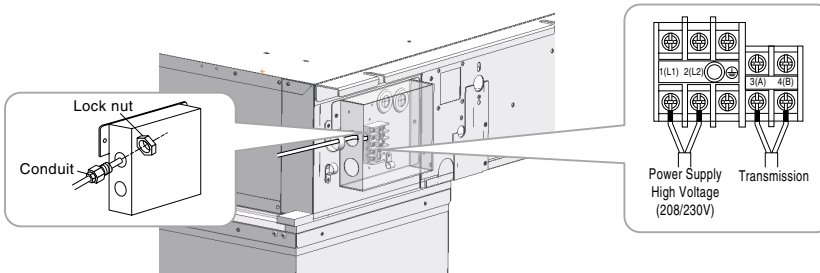

**WARNING :** Loose wiring may cause the terminal to overheat or result in unit malfunction.  
A fire hazard may also exist.  
Therefore, be sure all wiring is tightly connected.

Part name and functions

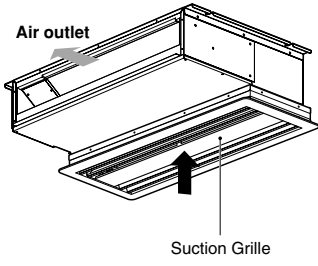

- Built-in duct type with Suction Grille.

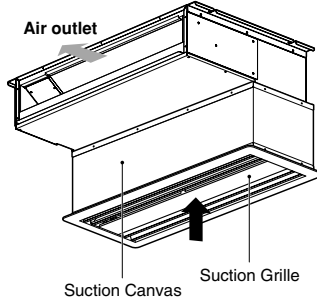

- Built-in duct type with Suction Grille and Suction Canvas.

ENGLISH

■ B3/B4 Series : Built-in Duct type Control Box service

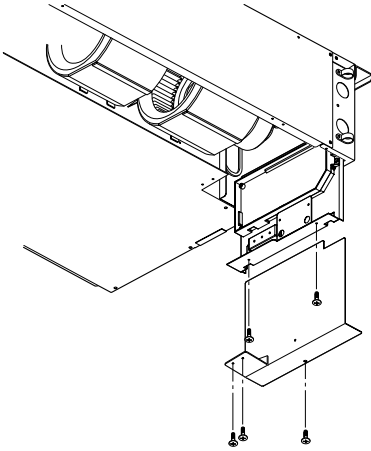

**INSULATION, OTHERS**

Insulate the joint and tubes completely.

**THERMAL INSULATION**

All thermal insulation must comply with local requirement.

**INDOOR UNIT**

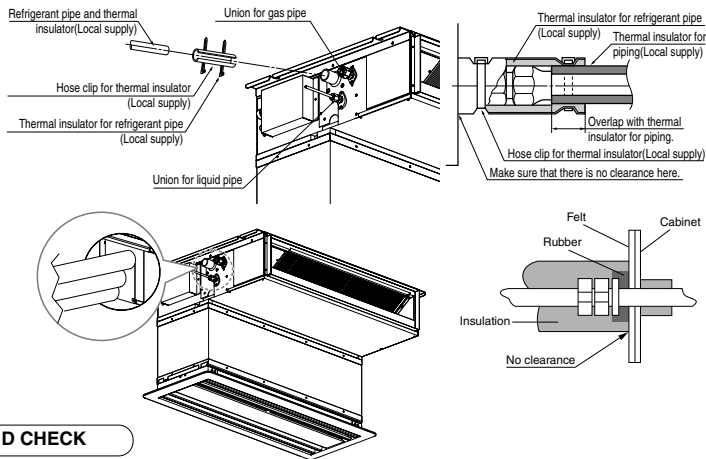

**TEST AND CHECK**

■ After all workings are finished, check the working and operation.

- Air distribution ..... Is the air circulation good?
- Drain ..... Is the drainage smoothly and no sweating?
- Gas leakage ..... Is the piping connection correctly?
- Wiring ..... Is the wiring connection correctly?
- Lock-bolt ..... Is the lock-bolt of compressor loosened?
- Insulation ..... Is the unit fully insulated?
- Ground ..... Is the unit safely grounded?

**Checking the Drainage**

**1. Remove the Air Filter.**

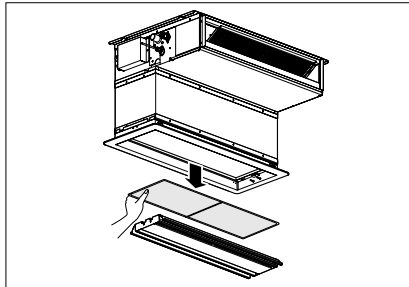

**2. Check the drainage.**

- Spray one or two glasses of water upon the evaporator.
- Ensure that water flows drain hose of indoor unit without any leakage.

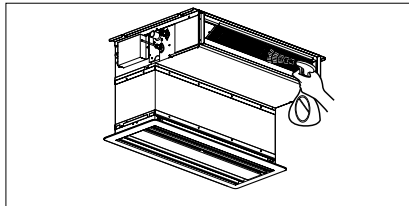

**CAUTION**

1. **Install declination** of the indoor unit is very **important for the drain** of the duct type air conditioner.
2. Minimum thickness of the insulation for the connecting pipe shall be 19mm.

**Front of view**

- The unit must be horizontal or declined to the drain hose connected when finished installation.

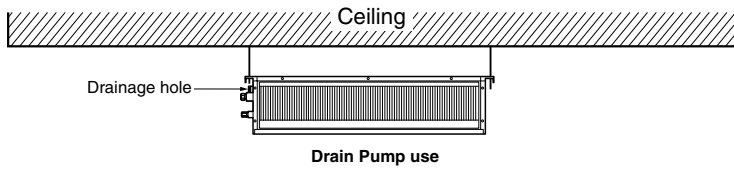

ENGLISH

**Drain Piping**

- Drain piping must have down-slope (1/50 to 1/100): be sure not to provide up-and-down slope to prevent reversal flow.
- During drain piping connection, be careful not to exert extra force on the drain port on the indoor unit.
- The outside diameter of the drain connection on the indoor unit is 32mm(1-1/4 inch).

Piping material: Polyvinyl chloride pipe 25mm(1 inch) and pipe fittings.

- Be sure to install heat insulation on the drain piping.

Heat insulation material: Polyethylene foam with thickness more than 8mm(5/16 inch).

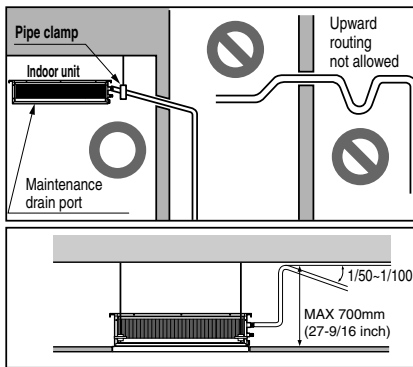

**Drain test**

The air conditioner uses a drain pump to drain water. Use the following procedure to test the drain pump operation:

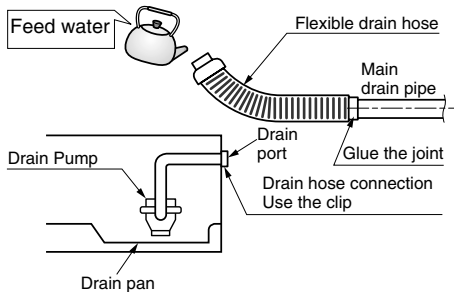

- Connect the main drain pipe to the exterior and leave it provisionally until the test comes to an end.
- Feed water to the flexible drain hose and check the piping for leakage.
- Be sure to check the drain pump for normal operating and noise when electrical wiring is complete.
- When the test is complete, connect the flexible drain hose to the drain port on the indoor unit.

**CAUTION :** The supplied flexible drain hose should not be curved, neither screwed. The curved or screwed hose may cause a leakage of water.

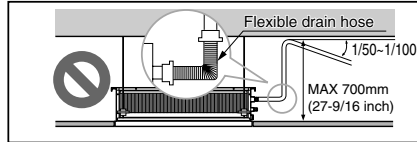

**CAUTION:**

After the confirmation of the above conditions, prepare the wiring as follows:

- 1) Never fail to have an individual power specialized for the air conditioner. As for the method of wiring, be guided by the circuit diagram posted on the inside of control box cover.
- 2) Provide a circuit breaker switch between power source and the unit.
- 3) The screws which fasten the wiring in the casing of electrical fittings are liable to come loose from vibrations to which the unit is subjected during the course of transportation. Check them and make sure that they are all tightly fastened. (If they are loose, it could give rise to burn-out of the wires.)
- 4) Specification of power source
- 5) Confirm that electrical capacity is sufficient.
- 6) Be sure that the starting voltage is maintained at more than 90 percent of the rated voltage marked on the name plate.
- 7) Confirm that the cable thickness is as specified in the power sources specification. (Particularly note the relation between cable length and thickness.)
- 8) Never fail to equip a leakage breaker where it is wet or moist.
- 9) The following troubles would be caused by voltage drop-down.
  - Vibration of a magnetic switch, damage on the contact point, fuse breaking, disturbance by the normal function of an overload protection device.
  - Proper starting power is not given to the compressor.

**HAND OVER**

Teach the customer the operation and maintenance procedures, using the operation manual. (air filter cleaning, temperature control, etc.)

## WIRED REMOTE CONTROLLER INSTALLATION

- Since the room temperature sensor is in the remote controller, the remote controller box should be installed in a place away from direct sunlight, high humidity and direct supply of cold air to maintain proper space temperature. Install the remote controller about 5ft(1.5m) above the floor in an area with good air circulation at an average temperature.

### Do not install the remote controller where it can be affected by:

- Drafts, or dead spots behind doors and in corners.
- Hot or cold air from ducts.
- Radiant heat from sun or appliances.
- Concealed pipes and chimneys.
- Uncontrolled areas such as an outside wall behind the remote controller.
- This remote controller is equipped with a seven segment LED. display. For proper display of the remote controller LED's, the remote controller should be installed properly as shown in Fig.1. (The standard height is 1.2~1.5 m from floor level.)

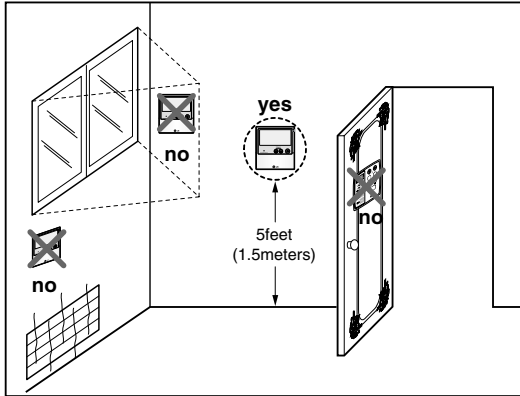

Fig.1 Typical locations for remote controller

ENGLISH

**Installation of Wired Remote Controller**

1. Connect the wired remote controller cable to the wired remote controller installation board as shown in the right picture.

12V	Red wire
SIG	Yellow wire
GND	Black wire

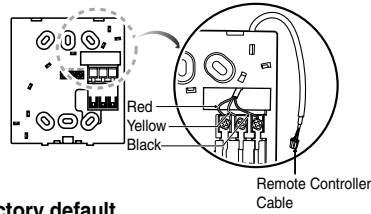

\* The wired remote controller cable is connected as factory default.

2. After fixing the cable to the guide slot, attach the wired remote controller installation board at the desired location.

• Before fixing the wired remote controller cable to the guide slot, remove any clogged part of the case in the direction to install before the installation.

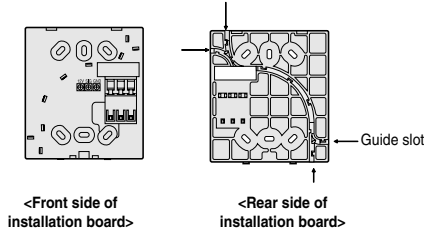

3. After locating the wired remote controller installation board at the desired location, screw the unit firmly. (When there is a buried box, install the wired remote controller board to fit the buried box.)

• Use the screw provided.

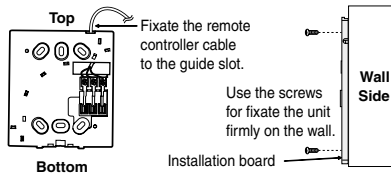

4. After fixing the top part of the wired remote controller to the installation board as shown in beside picture, press the bottom part to assemble the controller to it's board.

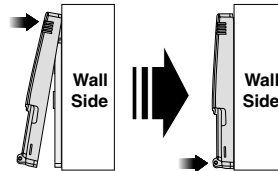

When disassemble the wired remote controller from the installation board, use the driver as shown in the right picture and insert it into the hole with the arrow. And when you pull the driver in the front direction, the wired remote controller will be separated.

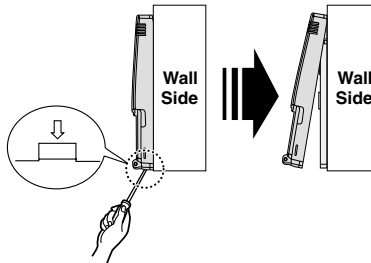

5. Use the connecting cable to connect the indoor unit and the wired remote controller.

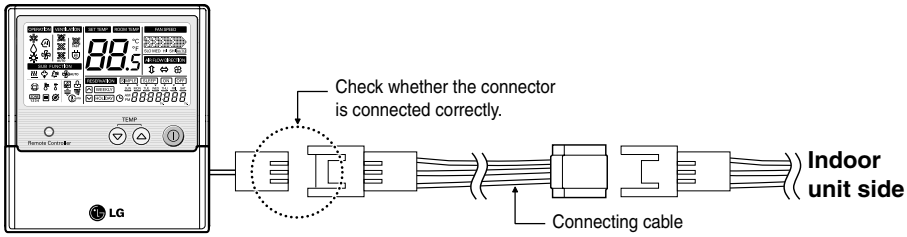

6. When the distance between the wired remote controller and the indoor unit is 10m and above, use the extension cable.

**CAUTION**

When installing the wired remote controller, do not bury it in the wall.

(It can cause damage in the temperature sensor.)

Do not install the cable to be 50m or above.

(It can cause communication error.)

- When installing the extension cable, check the connecting direction of the connector of the remote controller side and the product side for correct installation.
- If you install the extension cable in the opposite direction, the connector will not be connected.
- Specification of extension cable: 2547 1007 22# 2 core 3 shield 5 or above.

ENGLISH

**Optional Operation of Wired Remote Controller**

**Two Thermistor System**

1. Press button for 4 seconds to enter the installer setting mode until timer segment display "01:01".

2. Repeat pressing button to select Function code 04.

**04:01**

Function Code      Thermistor setting

3. Set Thermistor mode by pressing button (01: Remote Controller, 02: Indoor, 03: 2TH)

4. Press button to save or release

5. Press button to exit or system will automatically exit after 25 seconds without any input.

\* Therefore system will use value that sensed from indoor unit or remote controller

Temperature sensor location		Function
01	Remote controller	Operation in remote controller Temperature sensor
02	Indoor unit	Operation in indoor unit temperature sensor
03	2-Thermistor	Operation in lower temperature after comparing the temperature between the indoor unit and remote controller

\* If you want to know more Optional Operation, please refer to Wide Wired Remote Controller Manual.

## Dip Switch Setting

	Function	Description	Setting Off	Setting On	Default
SW1	Communication	N/A (Default)	-	-	Off
SW2	Cycle	N/A (Default)	-	-	Off
SW3	Group Control	Selection of Master or Slave	Master	Slave	Off
SW4	Dry Contact Mode	Selection of Dry Contact Mode	Wired/Wireless remote controller Selection of Manual or Auto operation Mode	Auto	Off
SW5	Installation	CST – No function	-	-	Off
		Duct – Fan continuous operation	Continuous operation Removal	Working	
		CVT – Selection of ceiling or floor	Ceiling	Floor	
		Console – Concealed or not	General installation	Concealed installation	
SW6	Heater linkage	N/A	-	-	Off
SW7	Ventilator linkage	Selection of Ventilator linkage	Linkage Removal	Working	Off
	Vane selection (Console)	Selection of up/down side Vane	Up side + Down side Vane	Up side Vane Only	
SW8	Etc.	Spare	-	-	Off

### CAUTION

For Multi V Models, Dip switch 1, 2, 6, 8 must be set OFF.  
That dip switch is used for other models.

ENGLISH

## Group Control Setting

### 1. Group Control 1

#### ■ Wired remote controller 1 + Indoor units

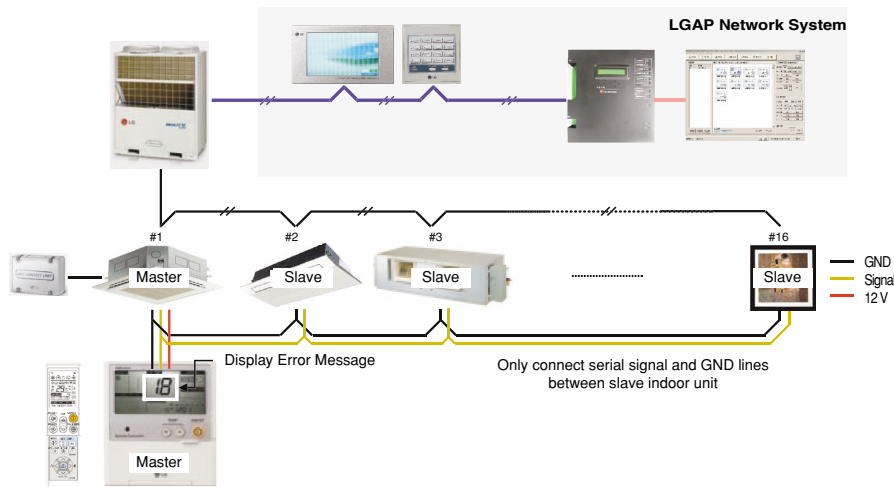

**1. It is possible to 16 indoor units(Max) by one wired remote controller.**

Set only one indoor unit to Master, set the others to Slave.

**2. It is possible to connect with every type of indoor units.**

**3. It is possible to use wireless remote controller at the same time.**

**4. It is possible to connect with Dry Contact and Central controller at the same time.**

The Master indoor unit is possible to recognize Dry Contact and Central controller only.

**5. In case of any error occurs at indoor unit, display on the wired remote controller.**

Exception of the error indoor unit, an individual indoor unit control possibility.

**6. In case of Group Control, be limited additional functions of indoor unit.**

- Selection of operation options (stop/mode/temperature)
- Control of flow rate (strong/middle/weak)
- Time reservation function
- Elevation grille

\* All kind of indoor units be set possible using a wireless remote controller, except cassette and duct types.  
Refer to wireless remote controller manual for setting group control.

\* It is possible to connect indoor units since Feb. 2009.  
In the other cases, please contact LGE.

## 2. Group Control 2

### ■ Wired remote controllers + Indoor units

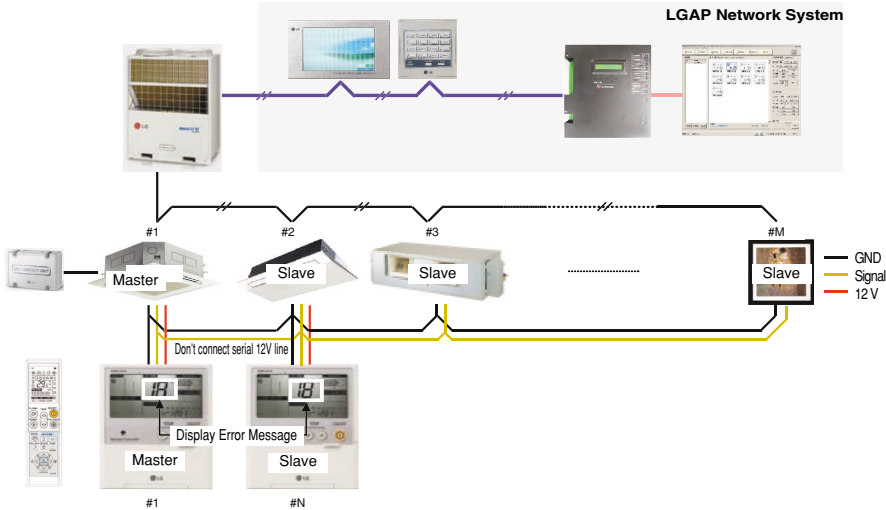

ENGLISH

**1. It is possible to control N indoor units by wired remote controller M units. ( $M+N \leq 17$  Units)**

Set only one indoor unit to Master, set the others to Slave.  
 Set only one wired remote controller to Master, set the others to Slave.  
 Other than those, it is same with the Group Control 1.

**2. It is possible to connect with every type of indoor units.**

**3. It is possible to use wireless remote controller at the same time.**

**4. It is possible to connect with Dry Contact and Central controller at the same time.**

The Master indoor unit is possible to recognize Dry Contact and Central controller only.

**5. In case of any error occurs at indoor unit, display on the wired remote controller.**

Exception of the error indoor unit, an individual indoor unit control possibility.

**6. In case of Group Control, be limited additional functions of indoor unit.**

- Selection of operation options (stop/mode/temperature)
- Control of flow rate (strong/middle/weak)
- Time reservation function
- Elevation grille

\* All kind of indoor units be set possible using a wireless remote controller, except cassette and duct types.  
 Refer to wireless remote controller manual for setting group control.

\* It is possible to connect indoor units since Feb. 2009.  
 In the other cases, please contact LGE.

### 3. 2 Remote Control

#### ■ Wired remote controller 2 + Indoor unit 1

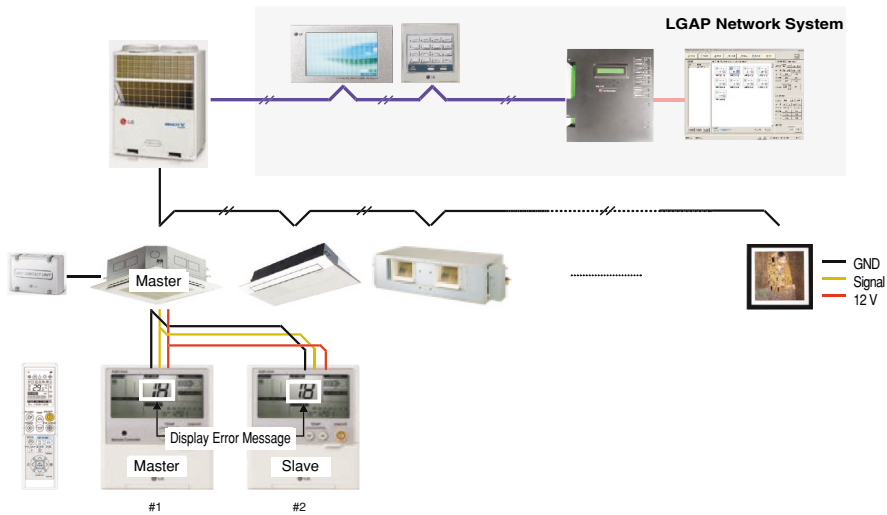

1. It is possible to connect two wired remote controllers with one indoor unit.
2. Every types of indoor unit is possible to connect two remote controller.
3. It is possible to use wireless remote controller at the same time.
4. It is possible to connect with Dry Contact and Central controller at the same time.
5. In case of any error occurs at indoor unit, display on the wired remote controller.
6. There isn't limits of indoor unit function.

# How to Set E.S.P.?





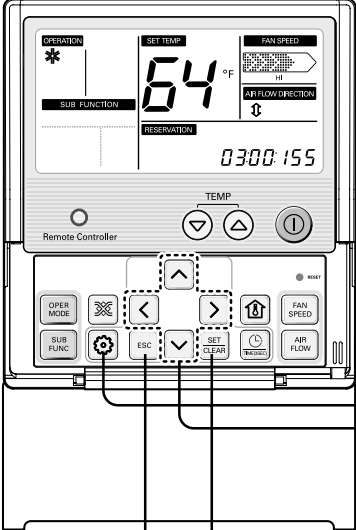

## What is an E.S.P function?

This is the function that decides the strength of the wind for each wind level and because this function is to make the installation easier, please do not use this function when using the remote controller.

### CAUTION

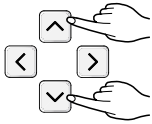
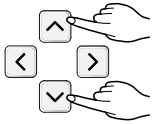
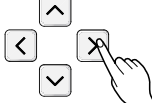
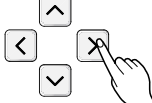
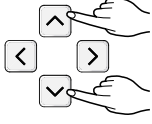
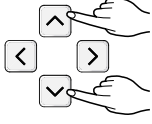
If you set ESP incorrectly, the air conditioner may malfunction.  
This setting must be carried out by a certificated-technician.  
This function is using for only Duct product



1. Press  button for 4 seconds to enter the installer setting mode until timer segment display "01:01". 
2. Repeat pressing Function Setting key to select Function code 03.  
**03:00:155**  
Function Code    ESP step    ESP value
3. Set ESP step by pressing  button (01: very low, 02: low, 03: medium, 04: high, 05: power). 
4. Move to ESP setting by pressing  button. 
5. Press  button to select ESP value(0~255). 
6. Press  button to save or release 
7. Press  button to exit or the system will automatically exit after 25 seconds without any input 

ENGLISH

\* Weak and Power setting is not available for some products.

\* Because the ESP value is already appropriately set when manufactured from the factory, it is recommended that you do not change the ESP value.

**ARNU073B3G2+PBSGB30(Accessory), PBSC30(Accessory)**

**ARNU093B3G2+PBSGB30(Accessory), PBSC30(Accessory)**

**ARNU123B3G2+PBSGB30(Accessory), PBSC30(Accessory)**

**ARNU153B3G2+PBSGB30(Accessory), PBSC30(Accessory)**

(Unit;cmm(cfm))

Setting Value	Static Pressure(mmAq (in.Aq))				
	0(0)	1(3.93)	2(7.87)	3(0.11)	4(0.15)
60	6.29(222)	3.03(107)	0.93(32)	-	-
65	6.61(233)	4.84(170)	1.52(53)	-	-
70	7.69(271)	5.64(199)	2.18(76)	0.79(27)	-
75	8.19(289)	6.28(221)	2.81(99)	0.85(30)	-
80	8.91(314)	7.43(262)	4.96(175)	1.58(55)	-
85	9.51(335)	8.14(287)	5.91(208)	2.75(97)	0.95(33)
90	10.21(360)	8.76(309)	6.79(239)	3.41(120)	1.36(48)
95	10.83(382)	9.62(339)	8.11(286)	5.48(193)	2.61(92)
100	11.31(399)	10.55(372)	9.02(318)	6.12(216)	3.31(116)
105	11.84(418)	11.19(395)	9.99(352)	8.28(292)	5.32(187)
110	12.68(447)	11.88(419)	10.38(366)	9.16(323)	6.92(244)
115	13.19(465)	12.22(431)	11.55(407)	10.21(360)	8.23(290)

**ARNU183B4G2+PBSGB40(Accessory), PBSC40(Accessory)**

**ARNU243B4G2+PBSGB40(Accessory), PBSC40(Accessory)**

(Unit;cmm(cfm))

Setting Value	Static Pressure(mmAq (in.Aq))				
	0(0)	1(3.93)	2(7.87)	3(0.11)	4(0.15)
75	10.32(364)	7.68(271)	3.55(125)	-	-
80	11.06(390)	8.77(309)	4.71(166)	1.38(48)	-
85	11.84(418)	10.02(353)	6.95(245)	2.16(76)	-
90	12.73(449)	10.74(379)	8.26(291)	4.73(167)	1.25(44)
95	13.47(475)	12.13(428)	9.93(350)	6.74(238)	2.73(96)
100	14.16(500)	13.25(467)	10.51(371)	8.41(297)	3.65(128)
105	15.29(539)	14.11(498)	12.31(434)	9.83(347)	6.21(219)
110	16.09(568)	14.77(521)	13.49(476)	10.39(366)	8.32(239)
115	16.91(597)	15.88(560)	14.48(511)	12.77(450)	9.92(350)
120	17.81(628)	16.88(596)	15.15(535)	13.98(493)	10.85(383)
125	18.55(655)	17.84(630)	16.12(569)	15.13(534)	12.97(458)
130	19.01(671)	18.55(655)	17.33(612)	16.28(574)	14.59(515)

**Note :**

1. The above table shows the correlation between the air rates and E.S.P.
2. E.S.P. is given after subtracting coil losses motor step factory installed
3. E.S.P. can be higher than the maximum given in the table, but the unit faces the problem of freezing the coil.

**ARNU073B3G2+PBSGB30(Accessory), PBSC30(Accessory)**  
**ARNU093B3G2+PBSGB30(Accessory), PBSC30(Accessory)**  
**ARNU123B3G2+PBSGB30(Accessory), PBSC30(Accessory)**  
**ARNU153B3G2+PBSGB30(Accessory), PBSC30(Accessory)**

Capacity	Mode		Set value	Standard ESP(mmAq (in.Aq))	cmm(cfm)	Lower Limit of External Static Pressure(mmAq (in.Aq))	Upper Limit of External Static Pressure(mmAq (in.Aq))
7k	High (factory set)	HI	94	2(7.87)	8(283)	-	4(0.15)
		Mid	88		6.5(229)		
		Low	83		5.5(194)		
	Standard	HI	74		8(283)		
		Mid	62		6.5(229)		
		Low	56		5.5(194)		
9k	High (factory set)	HI	99	2(7.87)	9(318)	-	4(0.15)
		Mid	89		7(247)		
		Low	85		6(212)		
	Standard	HI	82		9(318)		
		Mid	66		7(247)		
		Low	58		6(212)		
12k	High (factory set)	HI	105	2(7.87)	10(353)	-	4(0.15)
		Mid	94		8(282)		
		Low	88		6.5(229)		
	Standard	HI	90		10(353)		
		Mid	74		8(282)		
		Low	62		6.5(229)		
15k	High (factory set)	HI	110	2(7.87)	11(388)	-	4(0.15)
		Mid	105		10(353)		
		Low	94		8(283)		
	Standard	HI	96		11(388)		
		Mid	90		10(353)		
		Low	74		8(283)		

ENGLISH

**ARNU183B4G2+PBSGB40(Accessory), PBSC40(Accessory)**  
**ARNU243B4G2+PBSGB40(Accessory), PBSC40(Accessory)**

Capacity	Mode		Set value	Standard ESP(mmAq (in.Aq))	cmm(cfm)	Lower Limit of External Static Pressure(mmAq (in.Aq))	Upper Limit of External Static Pressure(mmAq (in.Aq))
18k	High (factory set)	HI	115	2(7.87)	14(494)	-	4(0.15)
		Mid	103		12(424)		
		Low	93		10(353)		
	Standard	HI	100		14(494)		
		Mid	86		12(424)		
		Low	74		10(353)		
24k	High (factory set)	HI	128	2(7.87)	17(600)	-	4(0.15)
		Mid	118		15(530)		
		Low	93		10(353)		
	Standard	HI	116		17(600)		
		Mid	104		15(530)		
		Low	74		10(353)		





P/No.: MFL42803119

Printed in Korea

After reading this manual, keep it in a place easily accessible to the user for future reference.