

This Owner's Manual is provided and hosted by [Appliance Factory Parts](#).



LG ARUB076DT2 Owner's Manual

[Shop genuine replacement parts for LG ARUB076DT2](#)



[Find Your LG Air Conditioner Parts - Select From 2328 Models](#)

----- Manual continues below -----



website <http://www.lgservice.com>

LG

ENGLISH

FRANÇAIS

ESPAÑOL

MULTI VTM SYNC^{II} System

Heat Recovery Outdoor Unit **R410A**

INSTALLATION MANUAL

MODELS: ARUB Series

IMPORTANT

- Please read this installation manual completely before installing the product.
- Installation work must be performed in accordance with the national wiring standards by authorized personnel only.
- Please retain this installation manual for future reference after reading it thoroughly.

IMPORTANT!

Please read this instruction sheet completely before installing the product.

This air conditioning system meets strict safety and operating standards. As the installer or service person, it is an important part of your job to install or service the system so it operates safely and efficiently.

WARNING

- Installation or repairs made by unqualified persons can result in hazards to you and others. Installation MUST conform with local building codes or, in the absence of local codes, with the National Electrical Code NFPA 70/ANSI C1-1993 or current edition and Canadian Electrical Code Part 1 CSA C.22.1.
- The information contained in the manual is intended for use by a qualified service technician familiar with safety procedures and equipped with the proper tools and test instruments.
- Failure to carefully read and follow all instructions in this manual can result in equipment malfunction, property damage, personal injury and/or death.

CAUTION: Improper installation, adjustment, alteration, service or maintenance can void the warranty. The weight of the condensing unit requires caution and proper handling procedures when lifting or moving to avoid personal injury. Use care to avoid contact with sharp or pointed edges.

Safety Precautions

- Always wear safety eye wear and work gloves when installing equipment.
- Never assume electrical power is disconnected. Check with meter and equipment.
- Keep hands out of fan areas when power is connected to equipment.
- R-410A causes frostbite burns.
- R-410A is toxic when burned.

NOTE TO INSTALLING DEALER: The Owners Instructions and Warranty are to be given to the owner or prominently displayed near the indoor Furnace/Air Handler Unit.

Special warnings

When wiring:

Electrical shock can cause severe personal injury or death. Only a qualified, experienced electrician should attempt to wire this system.

- Do not supply power to the unit until all wiring and tubing are completed or reconnected and checked.
- Highly dangerous electrical voltages are used in this system. Carefully refer to the wiring diagram and these instructions when wiring. Improper connections and inadequate grounding can cause accidental injury or death.
- Ground the unit following local electrical codes.
- Connect all wiring tightly. Loose wiring may cause overheating at connection points and a possible fire hazard.

When transporting:

Be careful when picking up and moving the indoor and outdoor units. Get a partner to help, and bend your knees when lifting to reduce strain on your back. Sharp edges or thin aluminum fins on the air conditioner can cut your finger.

When installing...

- ... **in a wall:** Make sure the wall is strong enough to hold the unit's weight. It may be necessary to construct a strong wood or metal frame to provide added support.
- ... **in a room:** Properly insulate any tubing run inside a room to prevent "sweating" that can cause dripping and water damage to wall and floors.
- ... **in moist or uneven locations:** Use a raised concrete pad or concrete blocks provide a solid, level foundation for the outdoor unit. This prevents water damage and abnormal vibration.
- ... **in an area with high winds:** Securely anchor the outdoor unit down with bolts and a metal frame. Provide a suitable air baffle.
- ... **in a snowy area (for Heat Pump Model):** Install the outdoor unit on a raised platform that is higher than drifting snow. Provide snow vents.

When connecting refrigerant tubing

- Keep all tubing runs as short as possible.
- Use the flare method for connecting tubing.
- Check carefully for leaks before starting the test run.

When servicing

- Turn the power OFF at the main power box (mains) before opening the unit to check or repair electrical parts and wiring.
- Keep your fingers and clothing away from any moving parts.
- Clean up the site after you finish, remembering to check that no metal scraps or bits of wiring have been left inside the unit being serviced.

TABLE OF CONTENTS

ENGLISH

Safety Precautions.....	4
Installation Process.....	8
Outdoor Unit Information.....	9
Environment-friendly Alternative Refrigerant R410A.....	13
Select the Best Location.....	13
Installation Space.....	15
Lifting method.....	19
Installation.....	20
Refrigerant piping installation.....	22
Electrical Wiring.....	41
HR unit PCB.....	54
Main PCB.....	65
Test Run.....	72
Caution For Refrigerant Leak.....	89
Installation guide at the seaside.....	91

Safety Precautions



To prevent injury to the user or other people and property damage, the following instructions must be followed.

■ Incorrect operation due to ignoring instruction will cause harm or damage. The seriousness is classified by the following indications.

⚠ WARNING This symbol indicates the possibility of death or serious injury.

⚠ CAUTION This symbol indicates the possibility of injury or damage to properties only.

■ Meanings of symbols used in this manual are as shown below.

	Be sure not to do.
	Be sure to follow the instruction.

⚠ WARNING

■ Installation

Have all electric work done by a licensed electrician according to "Electric Facility Engineering Standard" and "Interior Wire Regulations" and the instructions given in this manual and always use a special circuit.

- If the power source capacity is inadequate or electric work is performed improperly, electric shock or fire may result.

Always ground the product.

- There is risk of fire or electric shock.

For re-installation of the installed product, always contact a dealer or an Authorized Service Center.

- There is risk of fire, electric shock, explosion, or injury.

Do not store or use flammable gas or combustibles near the air conditioner.

- There is risk of fire or failure of product.

Prepare for strong wind or earthquake and install the unit at the specified place.

- Improper installation may cause the unit to topple and result in injury.

Ask the dealer or an authorized technician to install the air conditioner.

- Improper installation by the user may result in water leakage, electric shock, or fire.

Always install a dedicated circuit and breaker.

- Improper wiring or installation may cause fire or electric shock.

Do not install, remove, or re-install the unit by yourself (customer).

- There is risk of fire, electric shock, explosion, or injury.

Use the correctly rated breaker or fuse.

- There is risk of fire or electric shock.

Do not install the product on a defective installation stand.

- It may cause injury, accident, or damage to the product.

When installing and moving the air conditioner to another site, do not charge it with a different refrigerant from the refrigerant specified on the unit.

- If a different refrigerant or air is mixed with the original refrigerant, the refrigerant cycle may malfunction and the unit may be damaged.

Ventilate before operating air conditioner when gas leaked out.

- It may cause explosion, fire, and burn.

Do not reconstruct to change the settings of the protection devices.

- If the pressure switch, thermal switch, or other protection device is shorted and operated forcibly, or parts other than those specified by LGE are used, fire or explosion may result.

Securely install the cover of control box and the panel.

- If the cover and panel are not installed securely, dust or water may enter the outdoor unit and fire or electric shock may result.

If the air conditioner is installed in a small room, measures must be taken to prevent the refrigerant concentration from exceeding the safety limit when the refrigerant leaks.

- Consult the dealer regarding the appropriate measures to prevent the safety limit from being exceeded. Should the refrigerant leak and cause the safety limit to be exceeded, hazards due to lack of oxygen in the room could result.

■ **Operation**

Do not damage or use an unspecified power cord.

- There is risk of fire, electric shock, explosion, or injury.

Use a dedicated outlet for this appliance.

- There is risk of fire or electrical shock.

Be cautious that water could not enter the product.

- There is risk of fire, electric shock, or product damage.

Do not touch the power switch with wet hands.

- There is risk of fire, electric shock, explosion, or injury.

When the product is soaked (flooded or submerged), contact an Authorized Service Center.

- There is risk of fire or electric shock.

Be cautious not to touch the sharp edges when installing.

- It may cause injury.

Take care to ensure that nobody could step on or fall onto the outdoor unit.

- This could result in personal injury and product damage.

Do not open the inlet grille of the product during operation. (Do not touch the electrostatic filter, if the unit is so equipped.)

- There is risk of physical injury, electric shock, or product failure.



■ **Installation**

Always check for gas (refrigerant) leakage after installation or repair of product.

- Low refrigerant levels may cause failure of product.

Do not install the product where the noise or hot air from the outdoor unit could damage the neighborhoods.

- It may cause a problem for your neighbors.

Keep level even when installing the product.

- To avoid vibration or water leakage.

Use power cables of sufficient current carrying capacity and rating.

- Cables that are too small may leak, generate heat, and cause a fire.

Keep the unit away from children. The heat exchanger is very sharp.

- It can cause the injury, such as cutting the finger. Also the damaged fin may result in degradation of capacity.

Do not install the unit where combustible gas may leak.

- If the gas leaks and accumulates around the unit, an explosion may result.

Do not use the product for special purposes, such as preserving foods, works of art, etc. It is a consumer air conditioner, not a precision refrigeration system.

- There is risk of damage or loss of property.

When installing the unit in a hospital, communication station, or similar place, provide sufficient protection against noise.

- The inverter equipment, private power generator, high-frequency medical equipment, or radio communication equipment may cause the air conditioner to operate erroneously, or fail to operate. On the other hand, the air conditioner may affect such equipment by creating noise that disturbs medical treatment or image broadcasting.

Do not install the product where it is exposed to sea wind (salt spray) directly.

- It may cause corrosion on the product. Corrosion, particularly on the condenser and evaporator fins, could cause product malfunction or inefficient operation.

■ Operation

Do not use the air conditioner in special environments.

- Oil, steam, sulfuric smoke, etc. can significantly reduce the performance of the air conditioner or damage its parts.

Do not block the inlet or outlet.

- It may cause failure of appliance or accident.

Make the connections securely so that the outside force of the cable may not be applied to the terminals.

- Inadequate connection and fastening may generate heat and cause a fire.

Be sure the installation area does not deteriorate with age.

- If the base collapses, the air conditioner could fall with it, causing property damage, product failure, or personal injury.

Install and insulate the drain hose to ensure that water is drained away properly based on the installation manual.

- A bad connection may cause water leakage.

Be very careful about product transportation.

- Only one person should not carry the product if it weighs more than 20 kg.
- Some products use PP bands for packaging. Do not use any PP bands for a means of transportation. It is dangerous.
- Do not touch the heat exchanger fins. Doing so may cut your fingers.
- When transporting the outdoor unit, suspending it at the specified positions on the unit base. Also support the outdoor unit at four points so that it cannot slip sideways.

Safely dispose of the packing materials.

- Packing materials, such as nails and other metal or wooden parts, may cause stabs or other injuries.
- Tear apart and throw away plastic packaging bags so that children may not play with them. If children play with a plastic bag which was not torn apart, they face the risk of suffocation.

Do not touch any of the refrigerant piping during and after operation.

- It can cause a burn or frostbite.

Do not directly turn off the main power switch after stopping operation.

- Wait at least 5 minutes before turning off the main power switch. Otherwise it may result in water leakage or other problems.

Use a firm stool or ladder when cleaning or maintaining the air conditioner.

- Be careful and avoid personal injury.

Turn on the power at least 6 hours before starting operation.

- Starting operation immediately after turning on the main power switch can result in severe damage to internal parts. Keep the power switch turned on during the operational season.

Do not operate the air conditioner with the panels or guards removed.

- Rotating, hot, or high-voltage parts can cause injuries.

Auto-addressing should be done in condition of connecting the power of all indoor and outdoor units. Auto-addressing should also be done in case of changing the indoor unit PCB.**Do not insert hands or other objects through the air inlet or outlet while the air conditioner is plugged in.**

- There are sharp and moving parts that could cause personal injury.

Installation Process

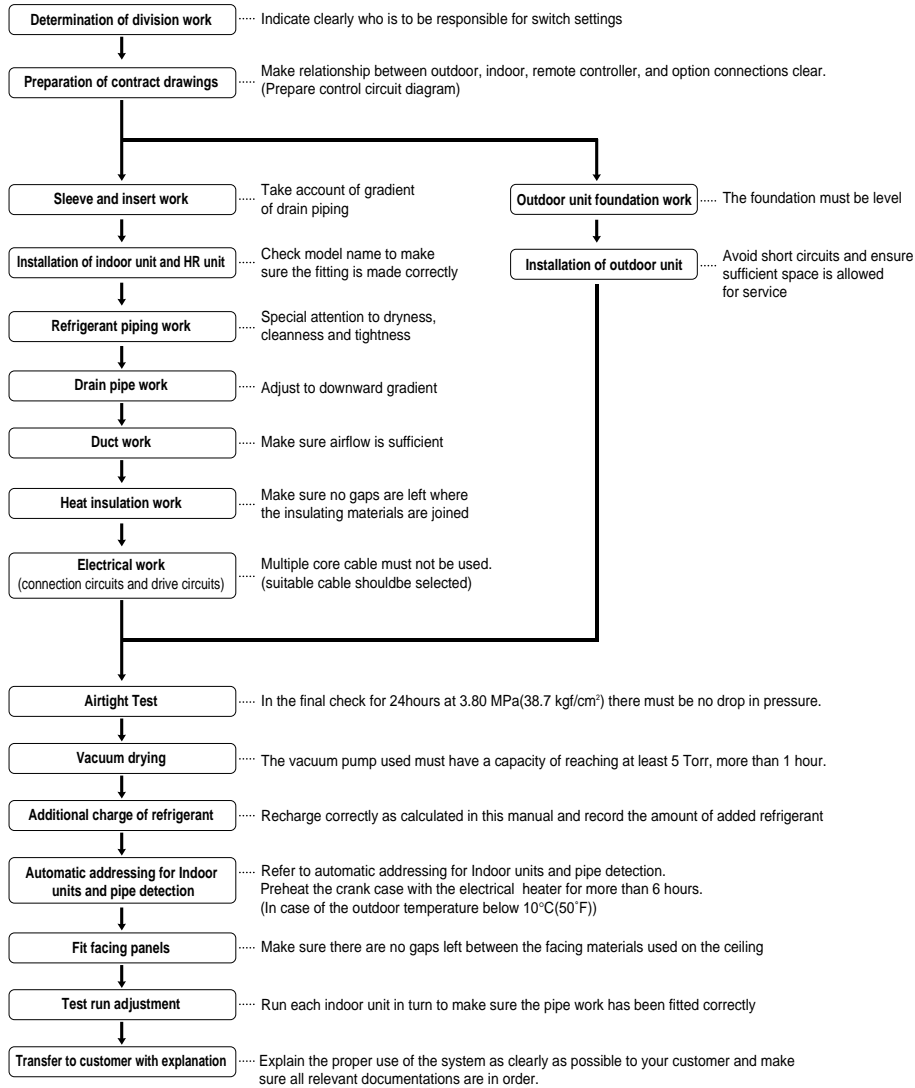

CAUTION:

The above list indicates the order in which the individual work operations are normally carried out but this order may be varied where local conditions warrants such change. Make sure additional charge the refrigerant before automatic addressing of indoor and pipe searching.

Outdoor Units Information

CAUTION: Ratio of the connectable Indoor Units to the Outdoor: Within 50 ~ 130%
 Ratio of the running Indoor Units to the Outdoor: Within 10 ~ 100%
 A combination operation over 100% cause to reduce the total capacity.

Power Supply: Outdoor Unit (3Ø, 208/230V, 60Hz)

ENGLISH

■ Heat Recovery

Unit		1 Outdoor Unit			2 Outdoor Units
Model(HP(Ton))		8(6.5)	10(8.0)	12(9.5)	16(12.5)
Model	Combination Unit	ARUB076BT2	ARUB096BT2	ARUB115BT2	ARUB154BT2
	Independent Unit				ARUB076BT2 ARUB076BT2
Product Charge	kg(lbs)	8(17.6)	8(17.6)	8(17.6)	8+8(17.6+17.6)
CF(Correction Factor)	kg(lbs)	-1(-2.2)	0(0)	1(2.2)	-2(-4.4)
Max. Connectable No. of Indoor Units		13	16	19	26
Net Weight	kg	285	285	285	285+285
	lbs	628	628	628	628+628
Dimensions (WxHxD)	mm	1,280x1,607x730	1,280x1,607x730	1,280x1,607x730	(1,280x1,607x730)x2
	inch	50-3/8 x 63-5/16 x 28-11/16	50-3/8 x 63-5/16 x 28-11/16	50-3/8 x 63-5/16 x 28-11/16	(50-3/8 x 63-5/16 x 28-11/16)x2
Connecting Pipes	Liquid Pipes[mm(inch)]	9.52(3/8)	9.52(3/8)	12.7(1/2)	12.7(1/2)
	Low Pressure Pipes[mm(inch)]	19.05(3/4)	22.2(7/8)	28.58(1 1/8)	28.58(1 1/8)
	High Pressure Gas Pipes[mm(inch)]	15.88(5/8)	19.05(3/4)	19.05(3/4)	22.2(7/8)

Unit		2 Outdoor Unit			
Model(HP(Ton))		18(14.5)	20(16.0)	22(17.5)	24(19.0)
Model	Combination Unit	ARUB173BT2	ARUB192BT2	ARUB211BT2	ARUB230BT2
	Independent Unit	ARUB096BT2 ARUB076BT2	ARUB096BT2 ARUB096BT2	ARUB115BT2 ARUB096BT2	ARUB115BT2 ARUB115BT2
Product Charge	kg(lbs)	8+8(17.6+17.6)	8+8(17.6+17.6)	8+8(17.6+17.6)	8+8(17.6+17.6)
CF(Correction Factor)	kg(lbs)	-1(-2.2)	0(0)	1(2.2)	2(4.4)
Max. Connectable No. of Indoor Units		29	32	35	39
Net Weight	kg	285+285	285+285	285+285	285+285
	lbs	628+628	628+628	628+628	628+628
Dimensions (WxHxD)	mm	(1,280x1,607x730)x2	(1,280x1,607x730)x2	(1,280x1,607x730)x2	(1,280x1,607x730)x2
	inch	(50-3/8 x 63-5/16 x 28-11/16)x2	(50-3/8 x 63-5/16 x 28-11/16)x2	(50-3/8 x 63-5/16 x 28-11/16)x2	(50-3/8 x 63-5/16 x 28-11/16)x2
Connecting Pipes	Liquid Pipes[mm(inch)]	15.88(5/8)	15.88(5/8)	15.88(5/8)	15.88(5/8)
	Low Pressure Pipes[mm(inch)]	28.58(1 1/8)	28.58(1 1/8)	34.9(1 3/8)	34.9(1 3/8)
	High Pressure Gas Pipes[mm(inch)]	22.2(7/8)	22.2(7/8)	28.58(1 1/8)	28.58(1 1/8)

Outdoor Units Information

Unit		3 Outdoor Units			
Model(HP(Ton))		26(20.5)	28(22.5)	30(24.0)	32(25.5)
Model	Combination Unit	ARUB250BT2	ARUB270BT2	ARUB290BT2	ARUB310BT2
		ARUB096BT2	ARUB096BT2	ARUB096BT2	ARUB115BT2
	Independent Unit	ARUB076BT2	ARUB096BT2	ARUB096BT2	ARUB096BT2
		ARUB076BT2	ARUB076BT2	ARUB096BT2	ARUB096BT2
Product Charge	kg(lbs)	8+8+8(17.6+17.6+17.6)	8+8+8(17.6+17.6+17.6)	8+8+8(17.6+17.6+17.6)	8+8+8(17.6+17.6+17.6)
CF(Correction Factor)	kg(lbs)	-2(-4.4)	-1(-2.2)	0(0)	1(2.2)
Max. Connectable No. of Indoor Units		42	45	49	52
Net Weight	kg	285+285+285	285+285+285	285+285+285	285+285+285
	lbs	628+628+628	628+628+628	628+628+628	628+628+628
Dimensions (WxHxD)	mm	(1,280x1,607x730)x3	(1,280x1,607x730)x3	(1,280x1,607x730)x2	(1,280x1,607x730)x2
	inch	(50.4x63.3x28.7)x3	(50.4x63.3x28.7)x3	(50.4x63.3x28.7)x2	(50.4x63.3x28.7)x2
Connecting Pipes	Liquid Pipes[mm(inch)]	19.05(3/4)	19.05(3/4)	19.05(3/4)	19.05(3/4)
	Low Pressure Pipes[mm(inch)]	34.9(1 3/8)	34.9(1 3/8)	34.9(1 3/8)	34.9(1 3/8)
	High Pressure Gas Pipes[mm(inch)]	28.58(1 1/8)	28.58(1 1/8)	28.58(1 1/8)	28.58(1 1/8)

Unit		3 Outdoor Units	
Model(HP(Ton))		34(27.0)	36(28.5)
Model	Combination Unit	ARUB330BT2	ARUB350BT2
		ARUB115BT2	ARUB115BT2
	Independent Unit	ARUB115BT2	ARUB115BT2
		ARUB096BT2	ARUB115BT2
Product Charge	kg(lbs)	8+8+8(17.6+17.6+17.6)	8+8+8(17.6+17.6+17.6)
CF(Correction Factor)	kg(lbs)	2(4.4)	3(6.6)
Max. Connectable No. of Indoor Units		55	58
Net Weight	kg	285+285+285	285+285+285
	lbs	628+628+628	628+628+628
Dimensions (WxHxD)	mm	(1,280x1,607x730)x2	(1,280x1,607x730)x2
	inch	(50.4x63.3x28.7)x2	(50.4x63.3x28.7)x2
Connecting Pipes	Liquid Pipes[mm(inch)]	19.05(3/4)	19.05(3/4)
	Low Pressure Pipes[mm(inch)]	34.9(1 3/8)	41.3(1 5/8)
	High Pressure Gas Pipes[mm(inch)]	28.58(1 1/8)	28.58(1 1/8)

Power Supply: Outdoor Unit (3Ø, 460V, 60Hz)

■ Heat Recovery

Unit		1 Outdoor Unit			
Model(HP(Ton))		8(6.5)	10(8.0)	12(9.5)	14(11.0)
Model	Combination Unit	ARUB076DT2	ARUB096DT2	ARUB115DT2	ARUB134DT2
	Independent Unit	ARUB076DT2	ARUB096DT2	ARUB115DT2	ARUB134DT2
Product Charge	kg(lbs)	8(17.6)	8(17.6)	8(17.6)	8(17.6)
CF(Correction Factor)	kg(lbs)	-1(-2.2)	0(0)	1(2.2)	2(4.4)
Max. Connectable No. of Indoor Units		13	16	20	23
Net Weight	kg	240	285	285	285
	lbs	529	628	628	628
Dimensions (WxHxD)	mm	1,280x1,607x730	1,280x1,607x730	1,280x1,607x730	1,280x1,607x730
	inch	50.4x63.3x28.7	50.4x63.3x28.7	50.4x63.3x28.7	50.4x63.3x28.7
Connecting Pipes	Liquid Pipes[mm(inch)]	9.52(3/8)	9.52(3/8)	12.7(1/2)	12.7(1/2)
	Low Pressure Pipes[mm(inch)]	19.05(3/4)	22.2(7/8)	28.58(1 1/8)	28.58(1 1/8)
	High Pressure Gas Pipes[mm(inch)]	15.88(5/8)	19.05(3/4)	19.05(3/4)	19.05(3/4)

Unit		1 Outdoor Unit	2 Outdoor Units		
Model(HP(Ton))		16(12.5)	18(14.5)	20(16.0)	22(17.5)
Model	Combination Unit	ARUB154DT2	ARUB173DT2	ARUB192DT2	ARUB211DT2
	Independent Unit	ARUB154DT2	ARUB096DT2	ARUB115DT2	ARUB134DT2
Product Charge	kg(lbs)	8(17.6)	8+8(17.6+17.6)	8+8(17.6+17.6)	8+8(17.6+17.6)
CF(Correction Factor)	kg(lbs)	3(6.6)	-1(-2.2)	0(0)	1(2.2)
Max. Connectable No. of Indoor Units		26	29	32	35
Net Weight	kg	285	285+240	285+240	285+240
	lbs	628	628+529	628+529	628+529
Dimensions (WxHxD)	mm	1,280x1,607x730	(1,280x1,607x730)x2	(1,280x1,607x730)x2	(1,280x1,607x730)x2
	inch	50.4x63.3x28.7	(50.4x63.3x28.7)x2	(50.4x63.3x28.7)x2	(50.4x63.3x28.7)x2
Connecting Pipes	Liquid Pipes[mm(inch)]	12.7(1/2)	15.88(5/8)	15.88(5/8)	15.88(5/8)
	Low Pressure Pipes[mm(inch)]	28.58(1 1/8)	28.58(1 1/8)	28.58(1 1/8)	28.58(1 1/8)
	High Pressure Gas Pipes[mm(inch)]	22.2(7/8)	22.2(7/8)	22.2(7/8)	28.58(1 1/8)

Unit		2 Outdoor Units			
Model(HP(Ton))		24(19.0)	26(20.5)	28(22.5)	30(24.0)
Model	Combination Unit	ARUB230DT2	ARUB250DT2	ARUB270DT2	ARUB290DT2
	Independent Unit	ARUB154DT2	ARUB134DT2	ARUB134DT2	ARUB154DT2
Product Charge	kg(lbs)	8+8(17.6+17.6)	8+8(17.6+17.6)	8+8(17.6+17.6)	8+8(17.6+17.6)
CF(Correction Factor)	kg(lbs)	2(4.4)	3(6.6)	4(8.8)	5(11.0)
Max. Connectable No. of Indoor Units		39	42	45	49
Net Weight	kg	285+240	285x2	285x2	285x2
	lbs	628+529	628x2	628x2	628x2
Dimensions (WxHxD)	mm	(1,280x1,607x730)x2	(1,280x1,607x730)x2	(1,280x1,607x730)x2	(1,280x1,607x730)x2
	inch	(50.4x63.3x28.7)x2	(50.4x63.3x28.7)x2	(50.4x63.3x28.7)x2	(50.4x63.3x28.7)x2
Connecting Pipes	Liquid Pipes[mm(inch)]	15.88(5/8)	19.05(3/4)	19.05(3/4)	19.05(3/4)
	Low Pressure Pipes[mm(inch)]	34.9(1 3/8)	34.9(1 3/8)	34.9(1 3/8)	34.9(1 3/8)
	High Pressure Gas Pipes[mm(inch)]	28.58(1 1/8)	28.58(1 1/8)	28.58(1 1/8)	28.58(1 1/8)

ENGLISH

Outdoor Units Information

Unit		2 Outdoor Units		3 Outdoor Units	
Model(HP(Ton))		32(25.5)	34(27.0)	36(28.5)	38(30.0)
Model	Combination Unit	ARUB310DT2	ARUB330DT2	ARUB350DT2	ARUB370DT2
	Independent Unit	ARUB154DT2	ARUB134DT2	ARUB134DT2	ARUB154DT2
		ARUB154DT2	ARUB115DT2	ARUB134DT2	ARUB134DT2
			ARUB076DT2	ARUB076DT2	ARUB076DT2
Product Charge	kg(lbs)	8+8(17.6+17.6)	8+8+8(17.6+17.6+17.6)	8+8+8(17.6+17.6+17.6)	8+8+8(17.6+17.6+17.6)
CF(Correction Factor)	kg(lbs)	6(13.2)	2(4.4)	3(6.6)	4(8.8)
Max. Connectable No. of Indoor Units		52	55	58	61
Net Weight	kg	285x2	285x2+240	285x2+240	285x2+240
	lbs	628x2	628x2 + 529	628x2 + 529	628x2 + 529
Dimensions (WxHxD)	mm	(1,280x1,607x730)x2	(1,280x1,607x730)x3	(1,280x1,607x730)x3	(1,280x1,607x730)x3
	inch	(50.4x63.3x28.7)x2	(50.4x63.3x28.7)x3	(50.4x63.3x28.7)x3	(50.4x63.3x28.7)x3
Connecting Pipes	Liquid Pipes[mm(inch)]	19.05(3/4)	19.05(3/4)	19.05(3/4)	19.05(3/4)
	Low Pressure Pipes[mm(inch)]	34.9(1 3/8)	34.9(1 3/8)	41.3(1 5/8)	41.3(1 5/8)
	High Pressure Gas Pipes[mm(inch)]	28.58(1 1/8)	28.58(1 1/8)	28.58(1 1/8)	28.58(1 1/8)

Unit		3 Outdoor Units			
Model(HP(Ton))		40(32.0)	42(33.5)	44(35.0)	46(36.5)
Model	Combination Unit	ARUB390DT2	ARUB410DT2	ARUB430DT2	ARUB450DT2
		ARUB154DT2	ARUB154DT2	ARUB154DT2	ARUB154DT2
	Independent Unit	ARUB154DT2	ARUB154DT2	ARUB154DT2	ARUB154DT2
		ARUB076DT2	ARUB096DT2	ARUB115DT2	ARUB134DT2
Product Charge	kg(lbs)	8+8+8(17.6+17.6+17.6)	8+8+8(17.6+17.6+17.6)	8+8+8(17.6+17.6+17.6)	8+8+8(17.6+17.6+17.6)
CF(Correction Factor)	kg(lbs)	5(11.0)	6(13.2)	7(15.4)	8(17.6)
Max. Connectable No. of Indoor Units		64	64	64	64
Net Weight	kg	285x2+240	285x3	285x3	285x3
	lbs	628x2 + 529	628x3	628x3	628x3
Dimensions (WxHxD)	mm	(1,280x1,607x730)x3	(1,280x1,607x730)x3	(1,280x1,607x730)x3	(1,280x1,607x730)x3
	inch	(50.4x63.3x28.7)x3	(50.4x63.3x28.7)x3	(50.4x63.3x28.7)x3	(50.4x63.3x28.7)x3
Connecting Pipes	Liquid Pipes[mm(inch)]	19.05(3/4)	19.05(3/4)	19.05(3/4)	19.05(3/4)
	Low Pressure Pipes[mm(inch)]	41.3(1 5/8)	41.3(1 5/8)	41.3(1 5/8)	41.3(1 5/8)
	High Pressure Gas Pipes[mm(inch)]	28.58(1 1/8)	28.58(1 1/8)	28.58(1 1/8)	28.58(1 1/8)

Unit		3 Outdoor Units	
Model(HP(Ton))		48(38.0)	
Model	Combination Unit	ARUB470DT2	
		ARUB154DT2	
	Independent Unit	ARUB154DT2	
		ARUB154DT2	
Product Charge	kg(lbs)	8+8+8(17.6+17.6+17.6)	
CF(Correction Factor)	kg(lbs)	9(19.8)	
Max. Connectable No. of Indoor Units		64	
Net Weight	kg	285x3	
	lbs	628x3	
Dimensions (WxHxD)	mm	(1,280x1,607x730)x3	
	inch	(50.4x63.3x28.7)x3	
Connecting Pipes	Liquid Pipes[mm(inch)]	19.05(3/4)	
	Low Pressure Pipes[mm(inch)]	41.3(1 5/8)	
	High Pressure Gas Pipes[mm(inch)]	28.58(1 1/8)	

Environment-friendly Alternative Refrigerant R410A

- The refrigerant R410A has the property of higher operating pressure in comparison with R22. Therefore, all materials have the characteristics of higher resisting pressure than R22 ones and this characteristic should be also considered during the installation.
- R410A is an azeotrope of R32 and R125 mixed at 50:50, so the ozone depletion potential (ODP) of R410A is 0. These days the developed countries have approved it as the environment-friendly refrigerant and encouraged to use it widely to prevent environment pollution.

CAUTION:

- The wall thickness of the piping should comply with the relevant local and national regulations for the designed pressure 3.8MPa
- Since R410A is a mixed refrigerant, the required additional refrigerant must be charged in its liquid state. If the refrigerant is charged in its gaseous state, its composition changes and the system will not work properly.
- Do not place the refrigerant container under the direct rays of the sun to prevent it from exploding.
- For high-pressure refrigerant, any unapproved pipe must not be used.
- Do not heat pipes more than necessary to prevent them from softening.
- Be careful not to install wrongly to minimize economic loss because it is expensive in comparison with R22.

ENGLISH

Select the Best Location

Select space for installing outdoor unit, which will meet the following conditions:

- No direct thermal radiation from other heat sources
- No possibility of annoying neighbors by noise from unit
- No exposition to strong wind
- With strength which bears weight of unit
- Note that drain flows out of unit when heating
- With space for air passage and service work shown next
- Because of the possibility of fire, do not install unit to the space where generation, inflow, stagnation, and leakage of combustible gas is expected.
- Avoid unit installation in a place where acidic solution and spray (sulfur) are often used.
- Do not use unit under any special environment where oil, steam and sulfuric gas exist.
- It is recommended to fence round the outdoor unit in order to prevent any person or animal from accessing the outdoor unit.
- If installation site is area of heavy snowfall, then the following directions should be observed.
 - Make the foundation as high as possible.
 - Fit a snow protection hood.
- Select installation location considering following conditions to avoid bad condition when additionally performing defrost operation.
 1. Install the outdoor unit at a place well ventilated and having a lot of sunshine in case of installing the product at a place with a high humidity in winter (neare beach, coast, lake, etc).
(Ex) Rooftop where sunshine always shines.
 2. Performance of heating will be reduced and preheat time of the indoor unit may be lengthened in case of installing the outdoor unit in winter at following location:
 - (1) Shade position with a narrow space
 - (2) Location with much moisture in neighboring floor.
 - (3) Location with much humidity around.
 - (4) Location where water gathers since the floor is not even.

■ Select installation location of the HR unit suitable for following conditions

- Avoid a place where rain may enter since the HR unit is for indoor.
- Sufficient service space must be obtained.
- Refrigerant pipe must not exceed limited length.
- Avoid a place subject to a strong radiation heat from other heat source.
- Avoid a place where oil spattering, vapor spray or high frequency electric noise is expected.
- Install the unit at a place in which it is not affected by operation noise. (Installation within cell such as meeting room etc. may disturb business due to noise.)
- Place where refrigerant piping, drain piping and electrical wiring works are easy.

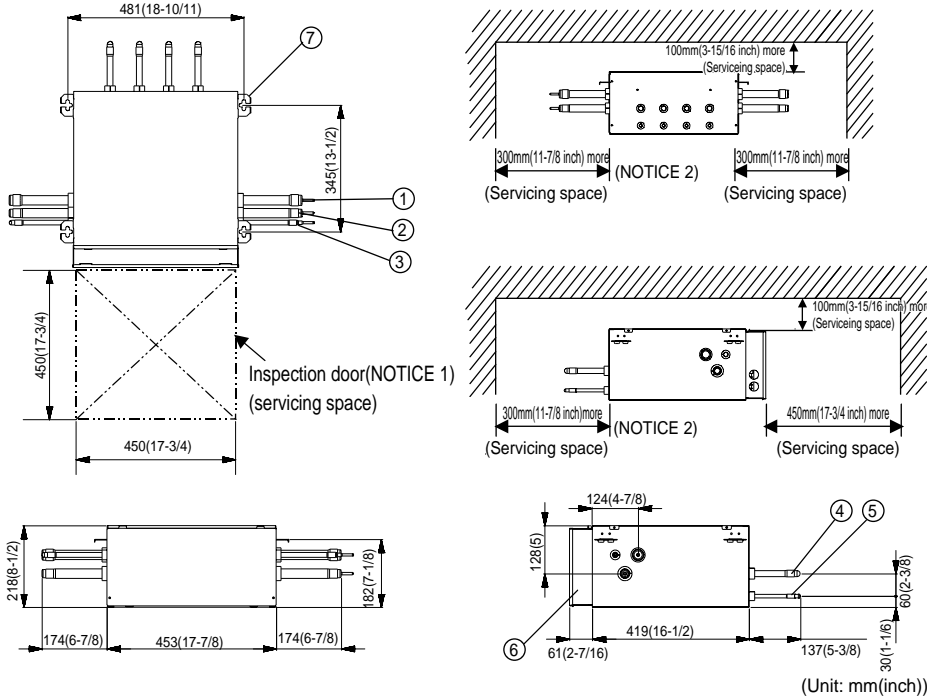

No.	Part Name	Description	
		PRHR030A/040A	PRHR020A
1	Low pressure Gas pipe connection port	Ø28.58(1-1/8) Brazing connection	Ø22.2(7/8) Brazing connection
2	High pressure Gas pipe connection port	Ø22.2(7/8) Brazing connection	Ø19.05(3/4) Brazing connection
3	Liquid pipe connection port	Ø12.7(1/2) Brazing connection	Ø9.52(3/8) Brazing connection
4	Indoor unit Gas pipe connection port	Ø15.88(5/8) Brazing connection	Ø15.88(5/8) Brazing connection
5	Indoor unit Liquid pipe connection port	Ø9.52(3/8) Brazing connection	Ø9.52(3/8) Brazing connection
6	Control box	-	-
7	Hanger metal	M10 or M8	M10 or M8

NOTICE :

1. Be sure to install the inspection door at the control box side.
2. If reducers are used, servicing space must be increased equal to reducer's dimension.

Installation Space

Individual Installation

ENGLISH

Basic space required

A space of at least 250mm(9-13/16 inch) is necessary at the back for inlet air. Taking servicing, etc. from the rear into account, a space of about 915mm(36 inches) should be provided, the same as at the front.

- Ⓐ 915mm(36 inches) or more (Control box is open/close type)
- Ⓑ 250mm(9-13/16 inch) or more
- Ⓒ Top discharge (open in principle)
- Ⓓ Front inlet (open in principle)
- Ⓔ Rear inlet (open in principle)

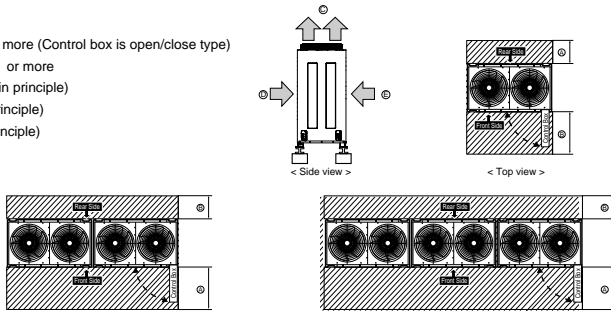

When inlet air enters from right and left sides of unit

- Ⓐ 915mm(36 inches) or more (Control box is open/close type)
- Ⓑ 250mm(9-13/16 inch) or more
- Ⓒ 150mm(5-7/8 inch) from the wall

CAUTION
Wall height(H) must not exceed height of the product. If the wall height is higher than the whole height of product by (h), Add (h) to Ⓐ, Ⓑ.

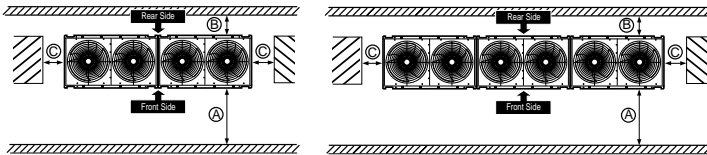
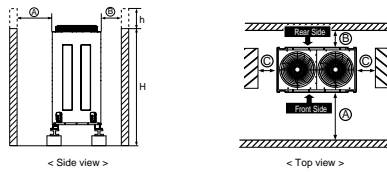

- Ⓐ 250mm(9-13/16 inch) or more (350mm(13-3/4 inch) or more at the coastal area.)
- Ⓑ 150mm(5-7/8 inch) from the wall

CAUTION
Wall height(H) must not exceed height of the product. If the wall height is higher than the whole height of product by (h), Add (h) to Ⓐ, Ⓑ.

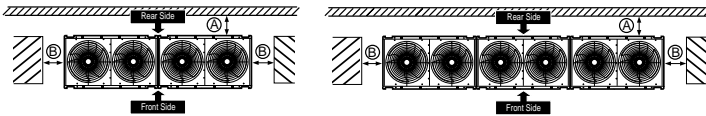
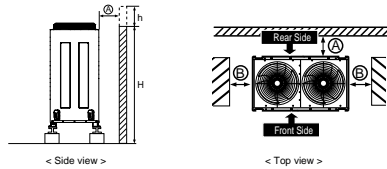

■ When unit is surrounded by walls

- Ⓐ 915mm(36 inches) or more (Control box is of a open/close type)
- Ⓑ 250mm(9-13/16 inch) or more

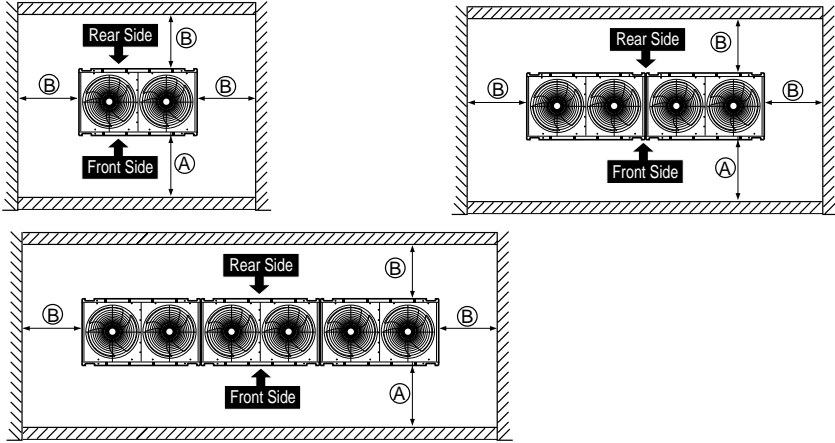

■ When there is an obstruction above the unit

- Ⓐ 45° or more
- Ⓑ 200mm(7-7/8 inch) or more
- Ⓒ 250mm(9-13/16 inch) or more

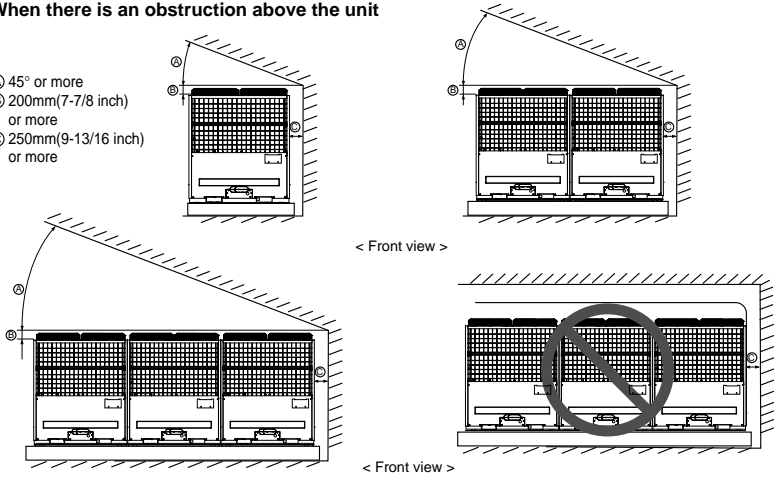

- Ⓓ Air guide
- Ⓔ Air outlet guide (Procured at the site)
- Ⓕ 250mm(9-13/16 inch) or more

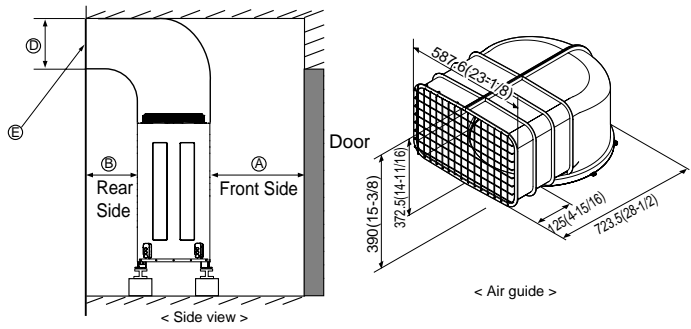

Collective / Continuous installation

Space required for collective installation and continuous installation: When installing several units, leave space between each block as shown below considering passage for air and people.

- Ⓐ (Be opened)
- Ⓑ 915mm(36 inches) or more (control box is of a open/close type)
- Ⓒ 250mm(9-13/16 inch) or more
- Ⓓ 150mm(5-7/8 inch) or more

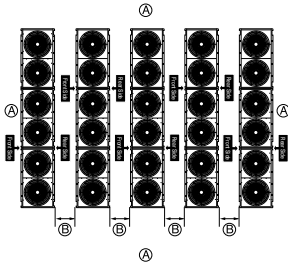
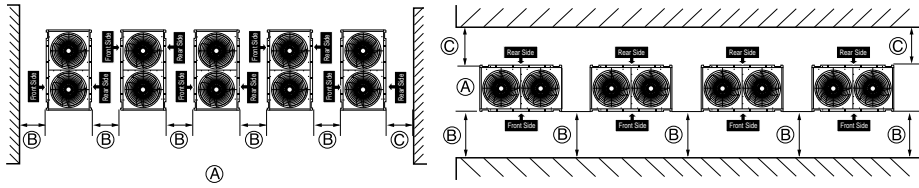

※ Ⓒ = 1250mm(49-1/4 inch) or more at the coastal area or strong wind area

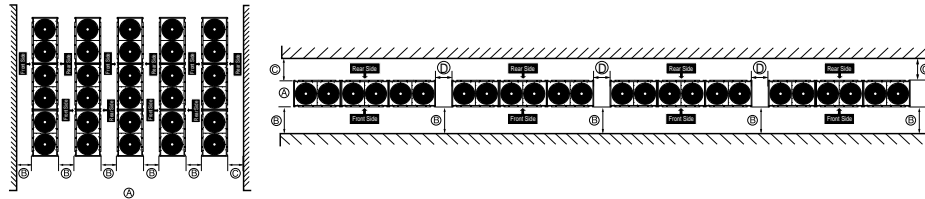
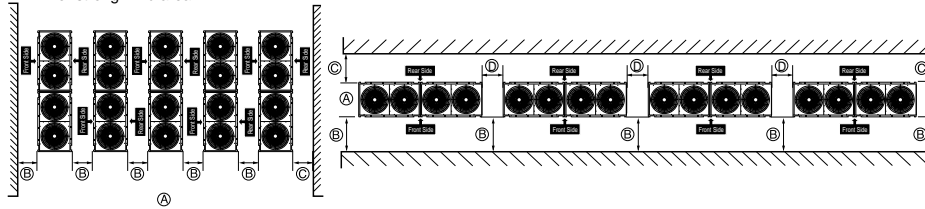

ENGLISH

Seasonal wind and cautions in winter

- Sufficient measures are required in a snow area or severe cold area in winter so that product can be operated well.
- Get ready for seasonal wind or snow in winter even in other areas.
- Install a suction and discharge duct not to let in snow or rain.
- Install the outdoor unit not to come in contact with snow directly. If snow piles up and freezes on the air suction hole, the system may malfunction. If it is installed at snowy area, attach the hood to the system.
- Install the outdoor unit at the higher installation console by 50cm(19.6 inch) than the average snowfall (annual average snowfall) if it is installed at the area with much snowfall.
- Where snow accumulated on the upper part of the Outdoor Unit by more than 10cm(3.9 inch), always remove snow for operation.

- | |
|--|
| <ol style="list-style-type: none">1. The height of H frame must be more than 2 times the snowfall and its width shall not exceed the width of the product. (If width of the frame is wider than that of the product, snow may accumulate)2. Don't install the suction hole and discharge hole of the Outdoor Unit facing the seasonal wind. |
|--|

Lifting method

- When carrying the suspended, unit pass the ropes under the unit and use the two suspension points each at the front and rear.
- Always lift the unit with ropes attached at four points so that impact is not applied to the unit.
- Attach the ropes to the unit at an angle of 40° or less.

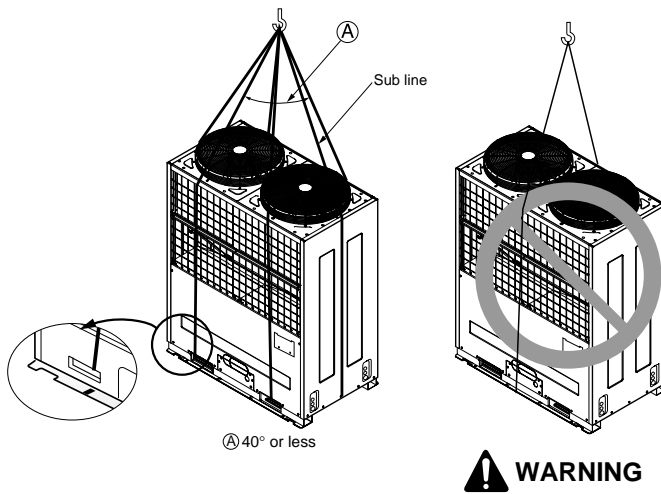

ENGLISH

! CAUTION

Be very careful while carrying the product.

- Do not have only one person carry product if it is more than 20 kg(44 lbs).
- PP bands are used to pack some products. Do not use them as a mean for transportation because they are dangerous.
- Do not touch heat exchanger fins with your bare hands. Otherwise you may get a cut in your hands.
- Tear plastic packaging bag and scrap it so that children cannot play with it. Otherwise plastic packaging bag may suffocate children to death.
- When carrying in Outdoor Unit, be sure to support it at four points. Carrying in and lifting with 3-point support may make Outdoor Unit unstable, resulting in a fall.
- Be very careful while carrying ARUN076DT2. It will be tilted in right side.

Installation

Location of anchor bolt(To be applied to 1, 2, 3 Units installation)

■ Individual installation

Unit: mm(inch)

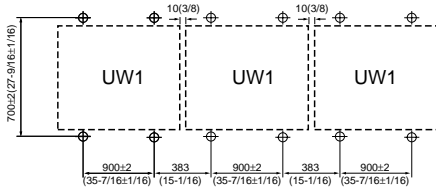

■ Collective installation

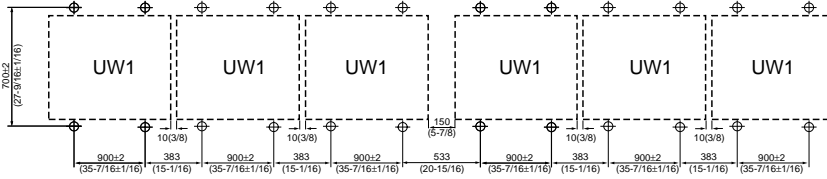

■ Installation foot(Location of anchor bolt)

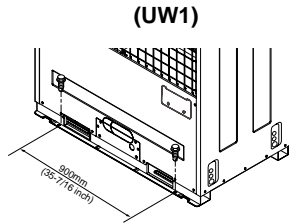

Foundation for Installation

- Fix the unit tightly with bolts as shown below so that unit will not fall down due to earthquake or gust.
- Use the H-beam support as a base support
- Noise and vibration may occur from the floor or wall since vibration is transferred through the installation part depending on installation status. Thus, use anti-vibration materials (cushion pad) fully (The base pad shall be more than 200mm(7.8 inch)).

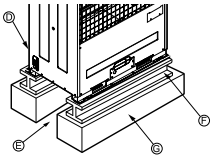
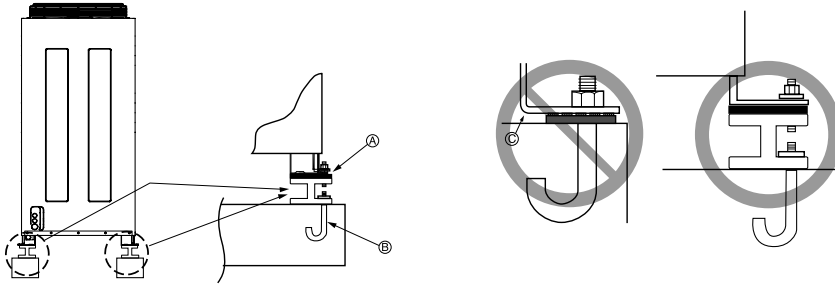

- Ⓐ Ensure that the corner part can be securely mounted. Otherwise, the support for installation may be bent.
- Ⓑ Obtain and use the M10 anchor bolt.
- Ⓒ The corner was not properly mounted.
- Ⓓ Outdoor unit (Insert the cushion pad between outdoor unit and base support to ensure that anti-vibration may be done in a wide area)
- Ⓔ Pipe and wiring space (in case of piping and wiring on the floor surface)
- Ⓕ H-Beam support
- Ⓖ Concrete base support

ENGLISH

WARNING

- Be sure to install unit in a place strong enough to withstand its weight. Any lack of strength may cause unit to fall down, resulting in a personal injury.
- Have installation work in order to protect against a strong wind and earthquake. Any installation deficiency may cause unit to fall down, resulting in a personal injury.
- Especially take care for support strength of the floor surface, water drain processing (processing of water flown out from the outdoor unit during operation) and paths of the pipe and wiring when making a base support.
- Don't use a tube or pipe for water drain in the base pan and perform water drain processing by using the drain path. Water drain may not be done due to freezing of a tube or pipe.

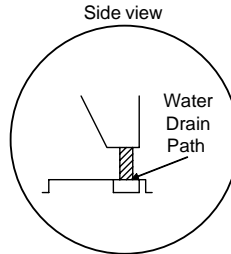
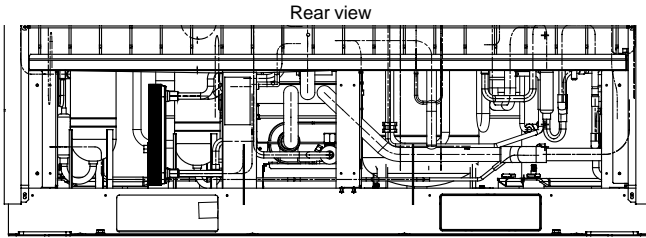

Refrigerant piping installation

⚠ WARNING

Always use extreme care to prevent the refrigerant gas (R410A) from leakage while using fire or flame. If the refrigerant gas comes in contact with the flame from any source, such as a gas stove, it breaks down and generates a poisonous gas which can cause gas poisoning. Never perform brazing in an unventilated room. Always conduct an inspection for gas leakage after installation of the refrigerant piping has been completed.

Cautions in pipe connection/valve operation

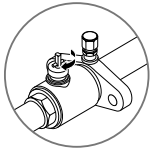

Open status when both the pipe and the valve are in a straight line.

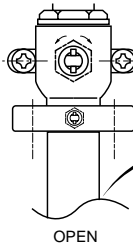
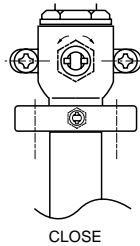

Cut both the pipe and the valve with a cutter to suit the length
(Don't cut the length of less than 70mm(2.8inch))

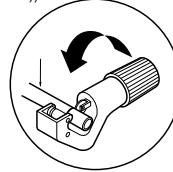

⚠ WARNING

After completing work, securely tighten both service ports and caps so that gas does not leak.

- ① Pipe joint (auxiliary parts): Securely perform brazing with a nitrogen blow into the service valve port. (Releasing pressure : 0.29 psi or less)
- ② Flare nut: Loose or tighten flare nut by using the wrench with both ends. Coat the flare connection part with oil for the compressor.
- ③ Cap: Remove caps and operate valve, etc. After operation, always reattach caps (tightening torque of valve cap: 25Nm (250kg-cm) or more). (Don't remove the internal part of the port)
- ④ Service port: Make the refrigerant pipe vacuum and charge it using the service port. Always reattach caps after completing work (tightening torque of service cap: 10 lbfft or more).
- ⑤ Liquid pipe
- ⑥ Gas pipe
- ⑦ Elbow joint (field supply)

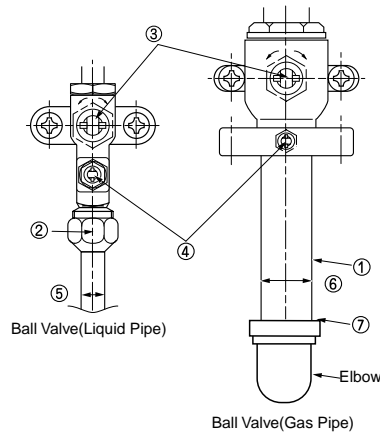

When connecting the pipes from the front of the outdoor unit, remove part ① and part ②.

When connecting the pipes from the side of the outdoor unit, remove part ③ (the whole "Knock out" part).

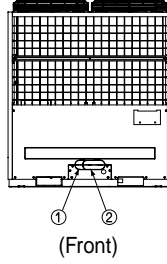

ENGLISH

⚠ WARNING

After installing the pipe, clog the pipe excavation inlet of the front panel and the side panel (Wire may be damaged due to entering of rats, animals, etc).

Connection of Outdoor Units

2 outdoor units

[Unit:mm(inch)]

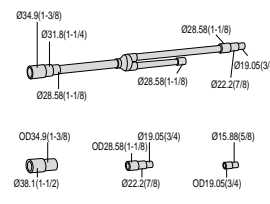
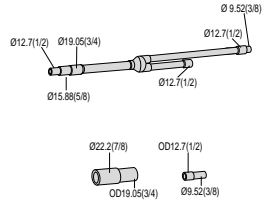
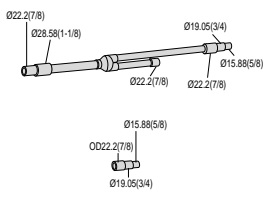
Model	Low Pressure Gas Pipe	Liquid Pipe	High Pressure Gas Pipe
ARCNB20			

3 outdoor units

[Unit:mm(inch)]

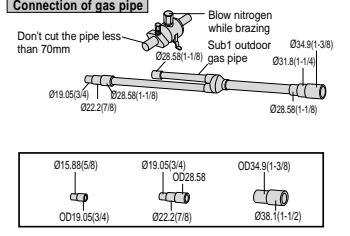
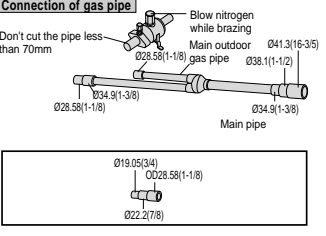
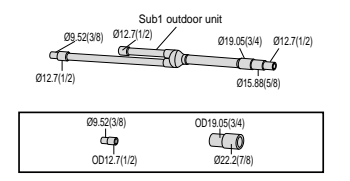
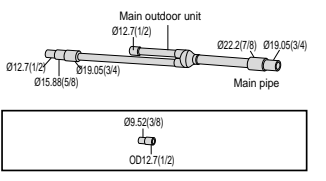
Model	Connection of gas pipe	Model	Connection of gas pipe
ARCNN20	<p>Don't cut the pipe less than 70mm</p> 	ARCNN30	<p>Don't cut the pipe less than 70mm</p> 
	<p>Sub1 outdoor unit</p> 		<p>Main outdoor unit</p> 

■ Y branch

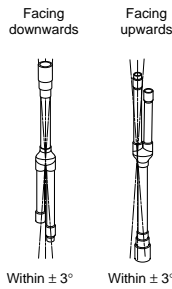
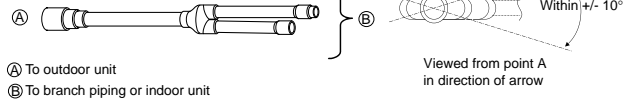

Installation procedure for HR unit

1. Using an insert-hole-in- anchor, hang the hanging bolt.
2. Install a hexagon nut and a flat washer (locally-procured) to the hanging bolt as shown in the figure in the bottom, and fit the main unit to hang on the hanger metal.
3. After checking with a level that the unit is level, tighten the hexagon nut.
* The tilt of the unit should be within $\pm 5^\circ$ in front/back and left/right.
4. This unit should be installed suspended from ceiling and side A should always be facing up.
5. Insulate not used pipes completely as shown in the figure.

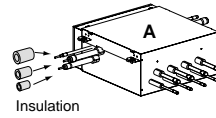
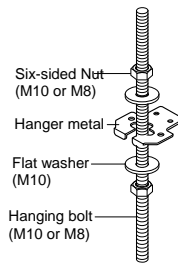

ENGLISH

Installation of Outdoor Unit, HR Unit, Indoor Unit Refrigerant Pipe

3 pipes are connected to the HR unit from the outdoor unit, classified into liquid pipe, low pressure gas pipe and high pressure gas pipe depending on status of refrigerant passing through the pipe.

You must connect 3 pipes from outdoor unit to HR unit.

For connection between indoor unit and HR unit, you must connect both liquid pipe and gas pipe from the HR unit to the indoor unit. In this case, connect them to the indoor unit starting from No.1 connection port of the HR unit (the port number is displayed on ports of the HR unit). Use auxiliary flare as annexed parts in connection to the indoor unit.

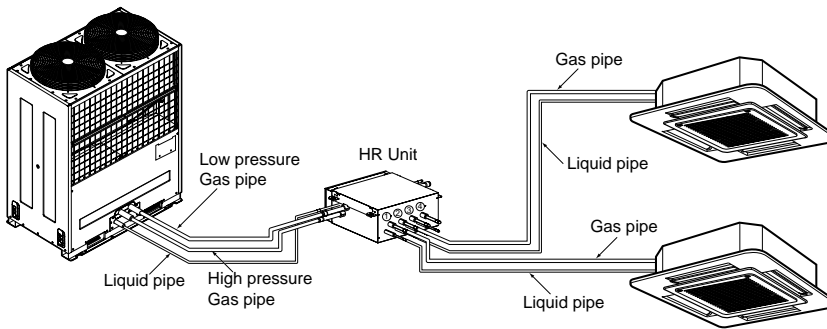

CAUTION:

Whenever connecting the indoor units with the HR unit, install the indoor units in numerical order from No.1.
Ex) In case of installing 3 indoor units : No. 1, 2, 3 (O), No. 1, 2, 4 (X), No.1, 3, 4 (X), No.2, 3, 4 (X).

Type of HR Unit

Select an HR unit according to the number of the indoor units to be installed. HR units are classified into 3 types by the number of connectable indoor units.

Ex) Installation of 6 indoor units

Consists of HR unit for 4 rooms and HR unit for 2 rooms.

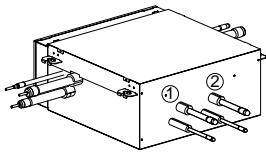

PRHR020A(2 rooms)

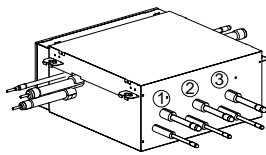

PRHR030A(3 rooms)

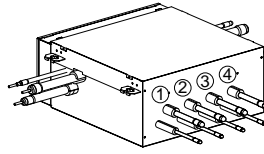

PRHR040A(4 rooms)

⚠ WARNING

- 1 port of HR unit allows up to 14.1kW based on cooling capacity of the indoor unit (up to 14.1kW (48MBh) for max installation).
- The maximum total capacity of the indoor units connected to one PRHR040 HR unit is 47kW (160MBh). In case of installation of four indoor units of 14.1kW (48MBh), use two PRHR020's rather than one PRHR040.

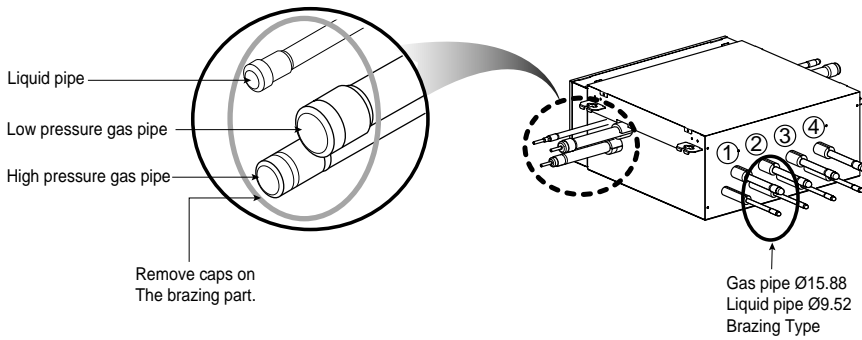









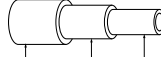

[Unit:mm(inch)]

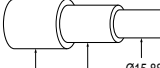
HR unit	PRHR020A	PRHR030A	PRHR040A
Low pressure gas pipe	Ø22.2(7/8)	Ø28.58(1-1/8)	Ø28.58(1-1/8)
High pressure gas pipe	Ø19.05(3/4)	Ø22.2(7/8)	Ø22.2(7/8)
Liquid pipe	Ø9.52(3/8)	Ø12.7(1/2)	Ø12.7(1/2)

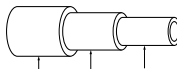
[Reducers for indoor unit and HR unit]

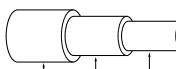
[Unit:mm(inch)]

Models		Liquid pipe	Gas pipe	
			High pressure	Low pressure
Indoor unit reducer		 OD9.52(3/8) Ø6.35(1/4)		 OD15.88(5/8) Ø12.7(1/2)
HR unit reducer	PRHR020A	 OD9.52(3/8) Ø6.35(1/4)	 OD19.05(3/4) Ø15.88(5/8) Ø12.7(1/2)  OD12.7(1/2) Ø9.52(3/8)	 OD22.2(7/8) Ø19.05(3/4) Ø15.88(5/8)  OD15.88(5/8) Ø12.7(1/2)
	PRHR030A PRHR040A	 OD12.7(1/2) Ø9.52(3/8)	 OD22.2(7/8) Ø19.05(3/4) Ø15.88(5/8)  OD15.88(5/8) Ø12.7(1/2)	 OD28.58(1-1/8) Ø22.2(7/8) Ø19.25(3/4)  OD19.05(3/4) Ø15.88(5/8)

ENGLISH

Caution

1. Use the following materials for refrigerant piping.
 - Material: Seamless phosphorous deoxidized copper pipe
 - Wall thickness : Comply with the relevant local and national regulations for the designed pressure 3.8MPa. We recommend the following table as the minimum wall thickness.

Outer diameter [mm(inch)]	6.35(1/4)	9.52(3/8)	12.7(1/2)	15.88(5/8)	19.05(3/4)	22.2(7/8)	25.4(1)
Minimum thickness [mm(inch)]	0.8(0.03)	0.8(0.03)	0.8(0.03)	0.99(0.03)	0.99(0.03)	0.99(0.03)	0.99(0.03)

2. Commercially available piping often contains dust and other materials. Always blow it clean with a dry inert gas.
3. Use care to prevent dust, water or other contaminants from entering the piping during installation.
4. Reduce the number of bending portions as much as possible, and make bending radius as big as possible.
5. Always use the branch piping set shown below, which are sold separately.

Y branch	
ARBLB01621	ARBLB03321
ARBLB07121	ARBLB14521

6. If the diameters of the branch piping of the designated refrigerant piping differs, use a pipe cutter to cut the connecting section and then use an adapter for connecting different diameters to connect the piping.
7. Always observe the restrictions on the refrigerant piping (such as rated length, difference in height, and piping diameter).
Failure to do so can result in equipment failure or a decline in heating/cooling performance.
8. The Multi V will stop due to an abnormality like excessive or insufficient refrigerant. At such a time, always properly charge the unit. When servicing, always check the notes concerning both the pipe length and the amount of additional refrigerant.
9. Never use refrigerant to perform an air purge. Always evacuate using a vacuum pump.
10. Always insulate the piping properly. Insufficient insulation will result in a decline in heating/cooling performance, drip of condensate and other such problems.
11. When connecting the refrigerant piping, make sure the service valves of the outdoor unit is completely closed (the factory setting) and do not operate it until the refrigerant piping for the outdoor and indoor units has been connected, a refrigerant leakage test has been performed and the evacuation process has been completed.
12. Always use a non-oxidizing brazing material for brazing the parts and do not use flux. If not, oxidized film can cause clogging or damage to the compressors and flux can harm the copper piping or refrigerant oil.
13. Diameter of the refrigerant pipe from the HR unit to the indoor unit is determined by capacity of the indoor unit. The pipe port is installed to suit a large capacity of the indoor unit for the connection flare of the HR unit. It is sufficient to cut, connect and install the subsidiary flare to suit the pipe of the indoor unit connected.
14. Take care so that there is no thermal damage on the service valves of the outdoor unit.
(Especially packing part of service port.) Wrap the service valve with a wet towel when brazing it.

! WARNING

When installing and moving the air conditioner to another site, be sure to make recharge refrigerant after perfect evacuation.

- If a different refrigerant or air is mixed with the original refrigerant, the refrigerant cycle may malfunction and the unit may be damaged.
- After selecting diameter of the refrigerant pipe to suit total capacity of the indoor unit connected after branching, use an appropriate branch pipe set according to the pipe diameter of the indoor unit and the installation pipe drawing.

ENGLISH

Pipe Length between Outdoor Units
(Low pressure gas pipe, High pressure gas pipe, Liquid pipe)

= Product length (1,280mm(50-3/8 inch)) + Max. 10(0.39) (distance between outdoor units)

Unit: mm(inch)

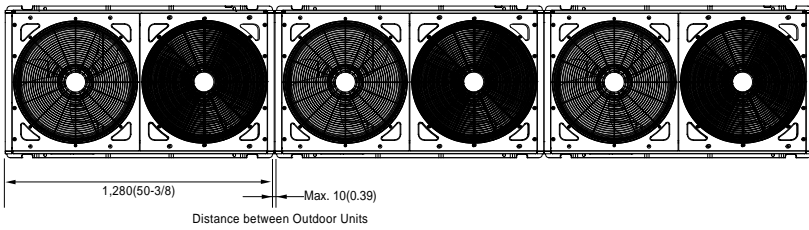



⊙ Refrigerant pipe diameter between branches and HR units (B,C,D)

Downward indoor unit total capacity [kW(Btu/h)]	Liquid pipe [mm(inch)]	Gas pipe [mm(inch)]	
		Low pressure	High pressure
≤ 5.6 (19,100)	Ø6.35(1/4)	Ø12.7(1/2)	Ø9.52(3/8)
< 16.0 (54,600)	Ø9.52(3/8)	Ø15.88(5/8)	Ø12.7(1/2)
< 22.4 (76,400)	Ø9.52(3/8)	Ø19.05(3/4)	Ø15.88(5/8)
< 33 (112,600)	Ø9.52(3/8)	Ø22.2(7/8)	Ø19.05(3/4)
< 47 (160,400)	Ø12.7(1/2)	Ø28.58(1-1/8)	Ø22.2(7/8)
< 71 (242,300)	Ø15.88(5/8)	Ø28.58(1-1/8)	Ø28.58(1-1/8)
< 104 (354,900)	Ø19.05(3/4)	Ø34.9(1-3/8)	Ø28.58(1-1/8)
104 (354,900) ≤	Ø19.05(3/4)	Ø41.3(1-5/8)	Ø28.58(1-1/8)

ENGLISH

⊙ Total pipe length (A+B+C1+C2+C3+D+a+b+c+d+e+f+g+i+j+k) ≤ 1,000m(3,280ft)

Ⓔ1 ~ Ⓔ10	Outdoor unit - the farthest indoor unit	Equivalent pipe length	 CAUTION • Assume equivalent pipe length of Y branch to be 0.5m(1.6ft), calculation purpose.
	A+B+C3+D+K ≤ 150m(492ft)(200m(656ft))(*)	A+B+C3+D+K ≤ 175m(574ft)(225m(738ft))(*)	
Ⓒ3 ~ Ⓒ4	HR Unit - neighboring HR Unit		 CAUTION: • Should not be exceed 10m(33ft) between neighboring HR unit. • Serial connection of HR units : Capacity sum of indoor units ≤ 160kBtu/hr.
	D ≤ 10m(33ft)		
Ⓑ1 ~ Ⓑ10	First indoor branch - the farthest indoor unit		
	B+C3+D+k ≤ 90m(295ft)(*)		
Ⓔ1 ~ Ⓔ3	First outdoor branch - the farthest outdoor unit		
	E+F3 ≤ 10m(33ft)		
H	Difference in height (outdoor unit ↔ indoor unit)		
	H ≤ 100m(328ft)		
h	Difference in height (indoor - indoor unit)		
	H ≤ 15m(49ft)		
g, i, j, k	Piping length from each indoor unit to the closest HR Unit		
	a,b,c,d,e,f,g, i, j, k ≤ 40m(131ft)		

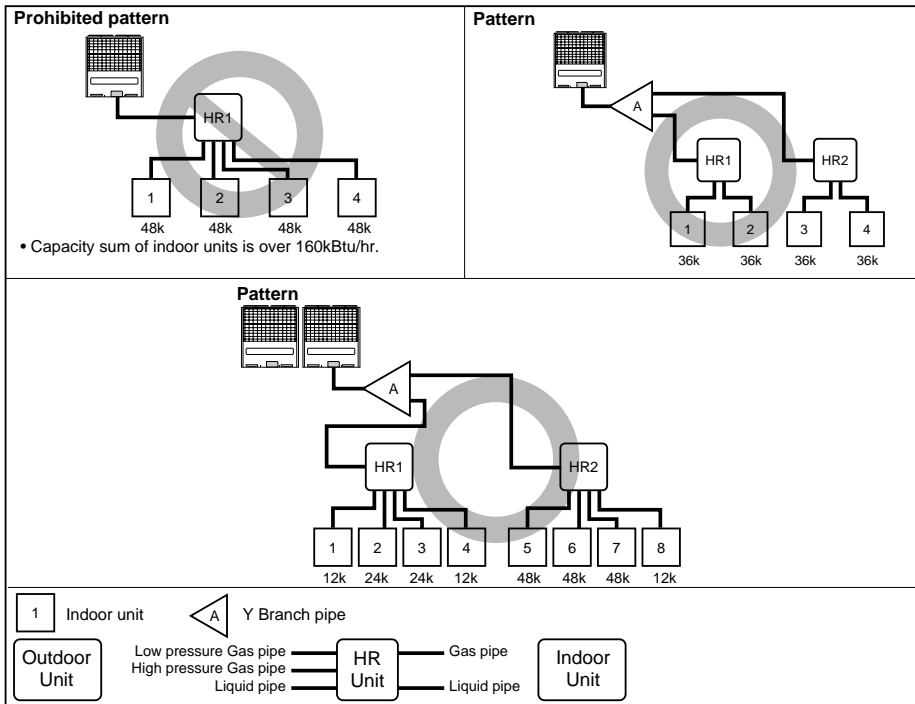

- 1) Keep the 40m distance from the first branch to the farthest indoor.
- 2) Keep the horizontal level between HR units. (for example, the same floor.)

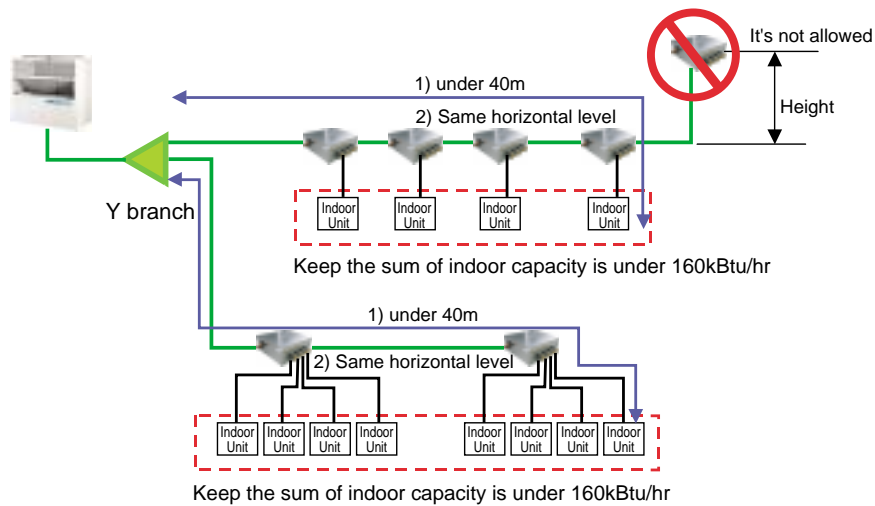

◆ Outdoor Unit Connection

○ Refrigerant pipe diameter before 1st branch (A,E,F)

Upward outdoor unit total capacity [HP]	Liquid pipe [mm(inch)]	Gas pipe [mm(inch)]	
		Low pressure	High pressure
8	Ø9.52(3/8)	Ø19.05(3/4)	Ø15.88(5/8)
10	Ø9.52(3/8)	Ø22.2(7/8)	Ø19.05(3/4)
12	Ø12.7(1/2)	Ø28.58(1-1/8)	Ø19.05(3/4)
14, 16	Ø12.7(1/2)	Ø28.58(1-1/8)	Ø22.2(7/8)
18, 20	Ø15.88(5/8)	Ø28.58(1-1/8)	Ø22.2(7/8)
22, 24	Ø15.88(5/8)	Ø34.9(1-3/8)	Ø28.58(1-1/8)

WARNING

Do not choose the main pipe diameter, namely A, by downward indoor unit total capacity but its outdoor unit model name.
Do not let the connection pipe from branch to branch exceed the main pipe diameter chosen by outdoor unit model name.
EX) Where connecting the indoor units to the 22 HP (61.5 kW) outdoor unit to 130% of its system capacity (79.9 kW) and branching one HR unit of four 7k indoor units (8.4kW) at the 1st branch.

Main pipe diameter(22 HP outdoor unit): Ø15.88(5/8)(Liquid pipe), Ø34.9(1-3/8)(Low pressure gas pipe),
Ø28.58(1-1/8)(High pressure gas pipe)

Pipe diameter between 1st and 2nd branch (71.5kW indoor units): Ø19.05(Liquid pipe), Ø34.9(1-3/8)(Low pressure gas pipe)
and Ø28.58(1-1/8)(High pressure gas pipe) in conformity with
downward indoor units.

Since the main pipe diameter of 22HP outdoor unit is Ø15.88(5/8)(Liquid pipe), Ø34.9(1-3/8)(Low pressure gas pipe) ,
Ø28.58(1-1/8)(High pressure gas pipe), it should be used as the diameter of the main pipe and the connection pipe between 1st and
2nd indoor branches.

WARNING

When the equivalent length between the outdoor unit and a indoor unit is 90 m or more, the size of main
pipes (only liquid pipe) must be increased one grade.

Liquid pipe
8, 10HP.....Ø9.52(3/8) → Ø12.7(1/2) 18, 20, 22, 24HP.....Ø15.88(5/8) → Ø19.05(3/4)
12, 14, 16HP.....Ø12.7(1/2) → Ø15.88(5/8)

◆ Indoor Unit Connection

○ Indoor unit connecting pipe from branch (a~k)

Indoor unit capacity [kW(Btu/h)]	Liquid pipe [mm(inch)]	Gas pipe [mm(inch)]
≤ 5.6(19,100)	Ø6.35(1/4)	Ø12.7(1/2)
< 16.0(54,600)	Ø9.52(3/8)	Ø15.88(5/8)
< 22.4(76,400)	Ø9.52(3/8)	Ø19.05(3/4)

◆ The Amount of Refrigerant

The calculation of the additional charge should take account of the length of pipe.

- (A)
- (B)
- = x 0.237 lbs/ft
- + x 0.178 lbs/ft
- + x 0.116 lbs/ft
- + x 0.079 lbs/ft
- + x 0.041 lbs/ft
- + x 0.015 lbs/ft
- + x 1.1 lbs
- +
- = (A) + (B)

CAUTION If a negative result is obtained from the calculation, no refrigerant needs to be added.

Ex) 10HP

Ⓐ Outdoor unit
Ⓑ HR unit (1EA)
Ⓒ Indoor unit

A: Ø12.7(1/2), 50m(164ft)
B: Ø9.52(3/8), 10m(33ft)
C: Ø9.52(3/8), 10m(33ft)
D: Ø9.52(3/8), 10m(33ft)
E: Ø6.35(1/4), 10m(33ft)

Additional Charge = A x 0.061 + B x 0.061 + C x 0.061 + (a+b+c+d+e) x 0.022 + CF
= 40 x 0.061 + 20 x 0.061 + 20 x 0.061 + (10 x 5) x 0.022 + 0.5(HR)+0(CF)
= 6.48(kg)

Additional Charge = A x 0.061 + B x 0.061 + C x 0.061 + (a + b + c + d + e) x 0.022 + CF
= 131 x 0.041 + 65.6 x 0.041 + 65.6 x 0.041 + (32.8 x 5) x 0.015 + 1.1(HR)+0(CF)
= 14.3(lbs)

HP(Ton)	8(6.5)	10(8.0)	12(9.5)	14(11.0)	16(12.5)	18(14.5)	20(16.0)	22(17.5)	24(19.0)	26(20.5)	28(22.5)
Product Charge(kg(lbs))	8 (17.6)	8 (17.6)	8 (17.6)	8 (17.6)	8 (17.6)	16 (35.3)	16 (35.3)	16 (35.3)	16 (35.3)	16 (35.2)	16 (35.2)
CF(kg(lbs))	-1 (-2.2)	0 (0)	1 (2.2)	2 (4.4)	3 (6.6)	-1 (-2.2)	0 (0)	1 (2.2)	2 (4.4)	3(6.6)	4(8.8)

HP(Ton)	30(24.0)	32(25.5)	34(27.0)	36(28.5)	38(30.0)	40(32.0)	42(33.5)	44(35.0)	46(36.5)	48(38.0)
Product Charge(kg(lbs))	16 (35.2)	16 (35.2)	24 (52.8)	24 (52.8)	24 (52.8)	24 (52.8)	24 (52.8)	24 (52.8)	24 (52.8)	24 (52.8)
CF(kg(lbs))	5(11.0)	6(13.2)	2(4.4)	3(6.6)	4(8.8)	5(11.0)	6(13.2)	7(15.4)	8(17.6)	9(19.8)

◆ Special condition

In case of the No. of CST TQ/RAC SE/ARTCOOL SF models are over than 50% of the connected indoor units when the total No. of connected indoor units are over than 50% of the max. connectable indoor units.

$$\text{Total amount(kg(lb))} = \text{Ⓐ} + \text{Ⓑ} + \text{Ⓒ}$$

■ Additional refrigerant charging amount (kg) : Ⓒ

$$= (A \times \alpha + B \times \beta) - (AVG \times \beta)$$

- A = Total No. of TQ,SE and SF Indoor units, $\alpha = 0.5$
- B = Total No. of except TQ,SE and SF Indoor units, $\beta = 0.3$
- AVG = 50% of Max. No. of connectable Indoor units.

Example)

1) Installation Information

- Outdoor unit : 6HP
- Total indoor units : 6 units (TQ 3 units, SE 2 units, BH 1 unit)

2) Information from PDB

- Max. No. of connectable indoor units : 10 units
- Calculated additional refrigerant amount = 2 kg(0.91 lb) : Ⓑ

3) Indoor refrigerant charging amount

$$= (5 \text{ units} \times 0.5 + 1 \text{ unit} \times 0.3) - (5 \text{ units} \times 0.3) = 1.3 \text{ kg}(0.59 \text{ lb}) : \text{Ⓒ}$$

- ▶ Revised the total additional charging amount = Ⓑ + Ⓒ = 2 kg(0.91 lb) + 1.3 kg(0.59 lb)
= 3.3 kg(1.50 lb)

WARNING

- ▶ Regulation for refrigerant leakage
: the amount of refrigerant leakage should satisfy the following equation for human safety.

$$\frac{\text{Total amount of refrigerant in the system}}{\text{Volume of the room at which indoor unit of the least capacity is installed}} \leq 0.44 \text{ kg} / \text{m}^3 (0.028 \text{ (lbs/ft}^3\text{)})$$

□ If the above equation can not be satisfied, then follow the following steps.

- Selection of air conditioning system: select one of the next
 1. Installation of effective opening part
 2. Reconfirmation of outdoor unit capacity and piping length
 3. Reduction of the amount of refrigerant
 4. Installation of 2 or more security device (alarm for gas leakage)
- Change indoor unit type
: installation position should be over 2m(6.6ft) from the floor (wall mounted type → cassette type)
- Adoption of ventilation system
: choose ordinary ventilation system or building ventilation system
- Limitation in piping work
: Prepare for earthquake and thermal stress

 **WARNING** ▶ Refer to model information since the CF value of correction factor differs depending on model.

Branch pipe Fitting

■ Y branch

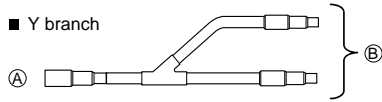

- Ⓐ To Outdoor Unit
- Ⓑ To Branch Piping or Indoor Unit

- Ensure that the branch pipes are attached horizontally or vertically (see the diagram below.)

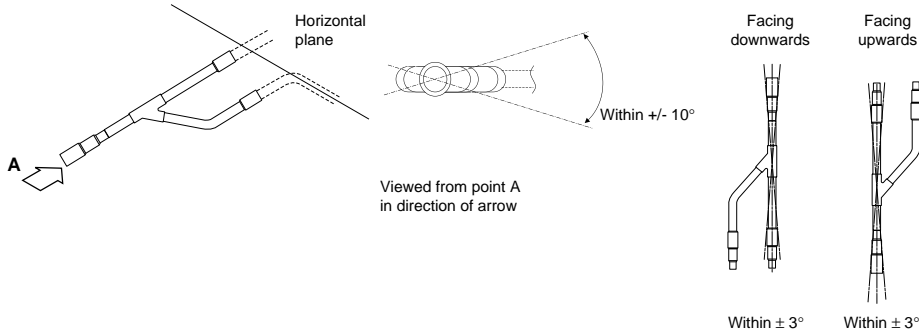

- There is no limitation on the joint mounting configuration.
- If the diameter of the refrigerant piping selected by the procedures described is different from the size of the joint, the connecting section should be cut with a pipe cutter.
- Branch pipe should be insulated with the insulator in each kit.

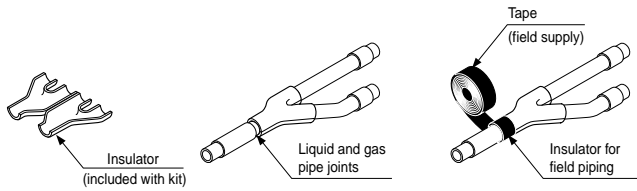

◆ Y branch pipe

[Unit:mm(inch)]

ENGLISH

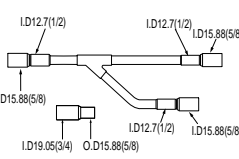
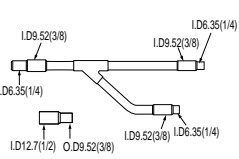
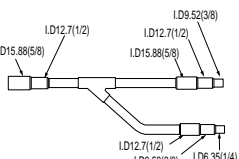
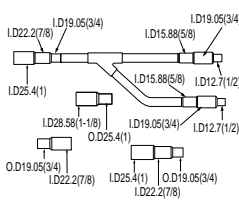
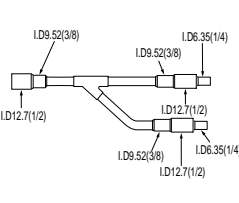
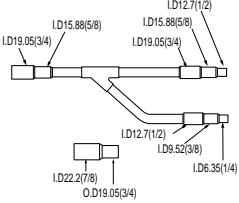
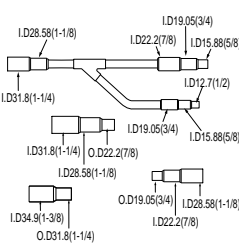
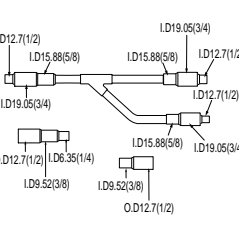
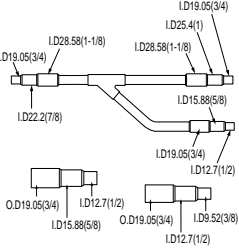
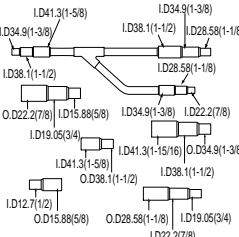
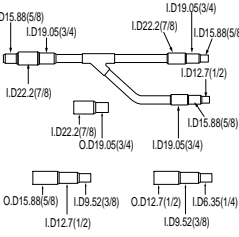
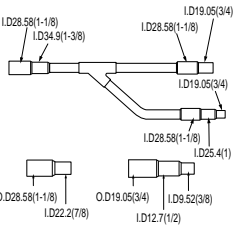
Models	Low Pressure Gas Pipe	Liquid pipe	High Pressure Gas Pipe
ARBLB01621			
ARBLB03321			
ARBLB07121			
ARBLB14521			

Leak Test and Vacuum

(1) Leak test

Leak test should be made by pressurizing nitrogen gas to 3.8 MPa(551 psi). For the test method, refer to the following figure. (Make a test with the service valves closed. Be also sure to pressurize low pressure gas pipe and liquid pipe simultaneously)
The test result can be judged good if the pressure has not be reduced after leaving for about one day after completion of nitrogen gas pressurization.

* When charging of refrigerant is needed due to a defect of outdoor unit, pressurize after opening the service valves.

During this test, please use the Vacuum Mode.

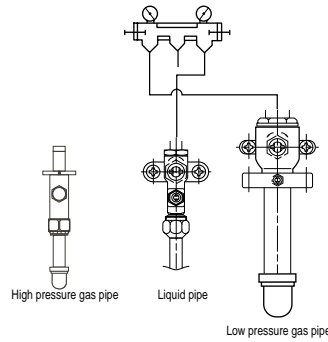

Note:

If the ambient temperature differs between the time when pressure is applied and when the pressure drop is checked, apply the following correction factor

There is a pressure change of approximately 0.01 Mpa(1.45 psi) for each 1°C of temperature difference.

Correction= (Temp. at the time of pressurization – Temp. at the time of check) X 0.1

For example: Temperature at the time of pressurization 3.8Mpa(551 psi) is 27 °C(80.6 °F)

24 hour later: 3.73 MPa(541 psi), 20°C(68 °F)

In this case the pressure drop of 0.07 is because of temperature drop

And hence there is no leakage in pipe occurred.

CAUTION

To prevent the nitrogen from entering the refrigeration system in the liquid state, the top of the cylinder must be at higher position than the bottom when you pressurize the system.
Usually the cylinder is used in a vertical standing position.

(2) Vacuum

Vacuum of the pipe and the indoor units should be made from the port of the outdoor unit's service valve with the service valve closed. Vacuum should be made from the high pressure gas pipe and the liquid pipe simultaneously with a vacuum pump including a vacuum gage. (The low pressure gas pipe becomes vacuum via the HR unit.) After the degree of vacuum gets to 5 Torr, keep vacuum for more than an hour.

* Never perform air purging by using refrigerant.

During this test, please using the Vacuum Mode.

• Vacuum drying : Use a vacuum pump that can evacuate to -100.7kPa (5 Torr, -755mmHg).

1. Evacuate the system from the liquid pipes and the high pressure gas pipes with a vacuum pump for over 2 hours and bring the system to -100.7kPa. After maintaining system under that condition for over 1 hour, confirm the vacuum gauge rises. If it rises, the system may contain moisture or leak.

2. Following should be executed if there is a possibility of moisture remaining inside the pipe.
(Rainwater may enter the pipe during work in the rainy season or over a long period of time)

After evacuating the system for 2 hours, give pressure to the system to 0.05 MPa(7.25 psi)(vacuum break) with nitrogen gas and then evacuate it again with the vacuum pump for 1 hour to -100.7kPa(vacuum drying). If the system cannot be evacuated to -100.7kPa within 2 hours, repeat the steps of vacuum break and its drying. Finally, check if the vacuum gauge rise or not, after maintaining the system in vacuum for 1 hour.

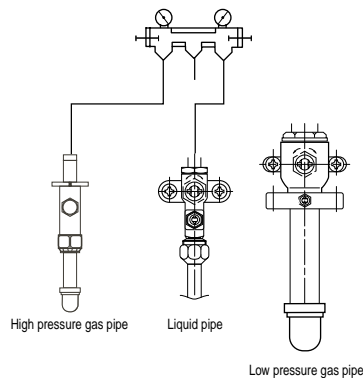

(3) Refrigerant Charged Method

After vacuum completion, primarily charge the calculated amount of additional refrigerant through the high pressure gas pipe and the liquid pipe. If the refrigerant is not charged any more, secondarily charge the remaining refrigerant through the low pressure gas pipe and the liquid pipe.

Vacuum and Primary charging

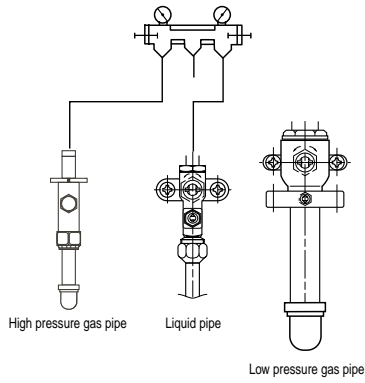

Secondary charging

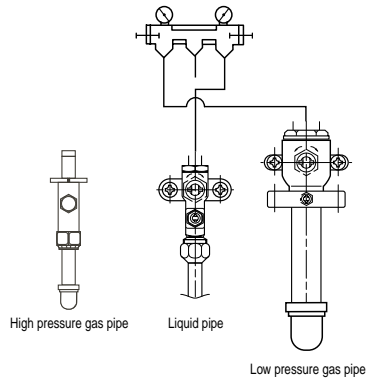

ENGLISH

! WARNING

- If the primary charging through the high pressure gas pipe and the liquid pipe is not performed after vacuum, wet air may go into the outdoor unit. If air is mixed with the refrigerant, the refrigerant cycle may malfunction and the unit may be damaged.
- Charging of refrigerant while the compressor is working is prohibited. Otherwise, liquid may go into the compressor. It may cause faults of the compressor.
- Use a gravimeter accurate to 0.1kg(0.2lb).
- Pipe to be vacuum: liquid pipe, high pressure gas pipe (low pressure gas pipe is vacuumed via the HR unit).
- If other refrigerants are mixed in the original refrigerant, a refrigerant cycle may cause malfunction or damage.
- Add accurate refrigerant quantity via calculation.
Too much or too little refrigerant may cause problems
- Repeated on and off of the indoor units without charging refrigerant may cause faults of EEV.
- Since R410A is a mixed refrigerant, the required additional refrigerant must be charged in its liquid state. If the refrigerant is charged in its gaseous state, its composition changes and the system will not work properly.

Thermal insulation of refrigerant piping

Be sure to give insulation work to refrigerant piping by covering liquid pipe and gas pipe separately with enough thickness heat-resistant polyethylene, so that no gap is observed in the joint between indoor unit and insulating material, and insulating materials themselves. When insulation work is insufficient, there is a possibility of condensation drip, etc. Pay special attention to insulation work to ceiling plenum.

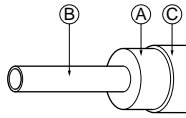

- (A) Heat insulation material
- (B) Pipe
- (C) Outer covering
(Wind the connection part and cutting part of heat insulation material with a finishing tape.)

Heat insulation material	Glass fiber	
	Adhesive + Heat - resistant polyethylene foam + Adhesive tape	
Outer covering	Indoor	Vinyl tape
	Floor exposed	Water-proof hemp cloth + Bronze asphalt
	Outdoor	Water-proof hemp cloth + Zinc plate + Oily paint

Note:
When using polyethylene cover as covering material, asphalt roofing shall not be required.

<p>Bad example</p>	<p>Do not insulate gas or low pressure pipe and liquid or high pressure pipe together.</p> <ul style="list-style-type: none"> (A) Liquid pipe (B) Gas pipe (C) Power lines (D) Finishing tape (E) Insulating material (F) Communication lines 	<p>Be sure to fully insulate connecting portion.</p> <p>(A) These parts are not insulated.</p>
<p>Good example</p>	<ul style="list-style-type: none"> (A) Liquid pipe (B) Low pressure gas pipe (C) Power lines (D) Finishing tape (E) Insulating material (F) High pressure gas pipe (G) Communication lines 	

Penetrations

Inner wall (concealed)

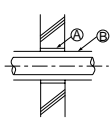

Outer wall

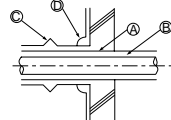

Outer wall (exposed)

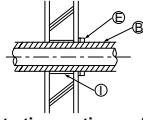

- (A) Sleeve
- (B) Heat insulating material
- (C) Lagging
- (D) Caulking material
- (E) Band
- (F) Waterproofing layer
- (G) Sleeve with edge
- (H) Lagging material
- (I) Mortar or other incombustible caulking
- (J) Incombustible heat insulation material

Floor (fireproofing)

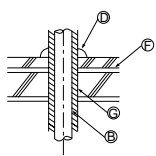

Roof pipe shaft

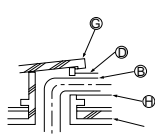

Penetrating portion on fire limit and boundary wall

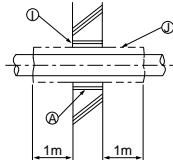

When filling a gap with mortar, cover the penetration part with steel plate so that the insulation material will not be caved in. For this part, use incombustible materials for both insulation and covering. (Vinyl covering should not be used.)

Electrical Wiring

Caution

1. Follow ordinance of your governmental organization for technical standard related to electrical equipment, wiring regulations and guidance of each electric power company.

! WARNING

Be sure to have authorized electrical engineers do the electric work using special circuits in accordance with regulations and this installation manual. If power supply circuit has a lack of capacity or electric work deficiency, it may cause an electric shock or fire.

2. Install the Outdoor Unit communication line away from the power source wiring so that it is not affected by electric noise from the power source. (Do not run it through the same conduit.)
3. Be sure to provide designated grounding work to Outdoor Unit.

! CAUTION

Be sure to correct the outdoor unit to earth. Do not connect earth line to any gas pipe, water pipe, lightning rod or telephone earth line. If earth is incomplete, it may cause an electric shock.

4. Give some allowance to wiring for electrical part box of Indoor and Outdoor Units, because the box is sometimes removed at the time of service work.
5. Never connect the main power source to terminal block of communication line. If connected, electrical parts will be burnt out.
6. Use 2-core shield cable for communication line. (O mark in the figure below) If communication lines of different systems are wired with the same multicore cable, the resultant poor transmitting and receiving will cause erroneous operations. (⊗ mark in the figure below)
7. Only the communication line specified should be connected to the terminal block for Outdoor Unit communication.

ENGLISH

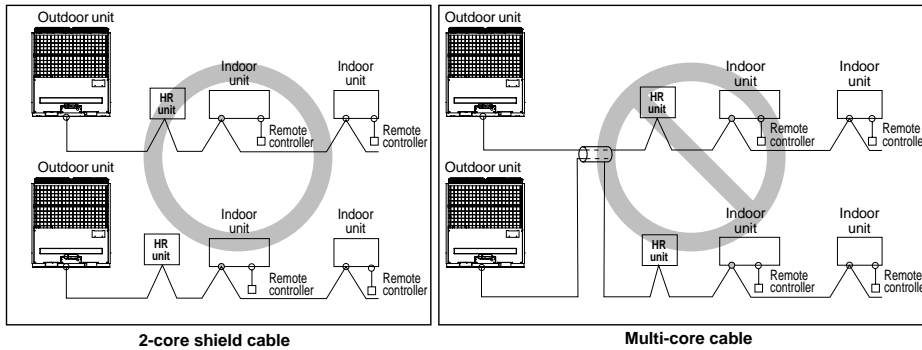

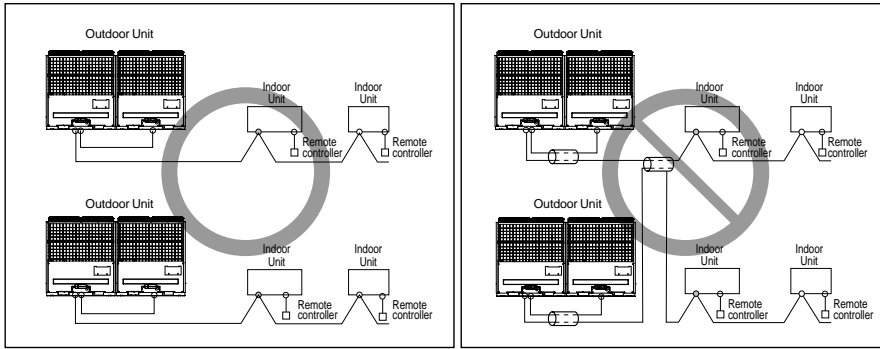

2-Core Shield Cable

Multi-Core Cable

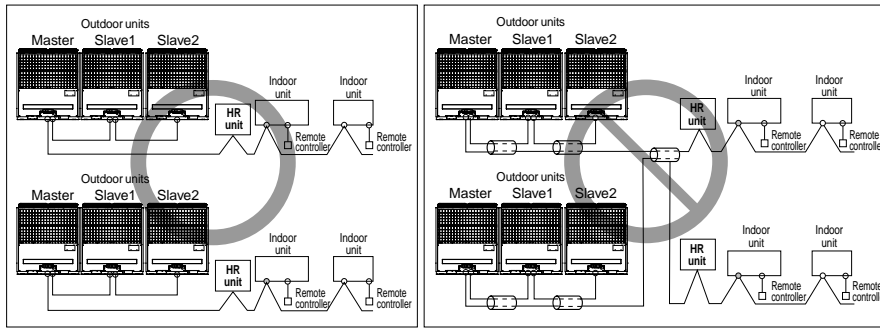

2-core shield cable

Multi-core cable

CAUTION

- Use the 2-core shield cables for communication lines. Never use them together with power cables.
- The conductive shielding layer of cable should be grounded to the metal part of both units.
- Never use multi-core cable
- As this unit is equipped with an inverter, to install a phase leading capacitor not only will deteriorate power factor improvement effect, but also may cause capacitor abnormal heating. Therefore, never install a phase leading capacitor.
- Keep power imbalance within 2% of the supply rating. Large imbalance will shorten the life of the smoothing capacitor.

Control box and connecting position of wiring

- Remove all of the screws on front panel, and remove the front panel by pulling it forward.

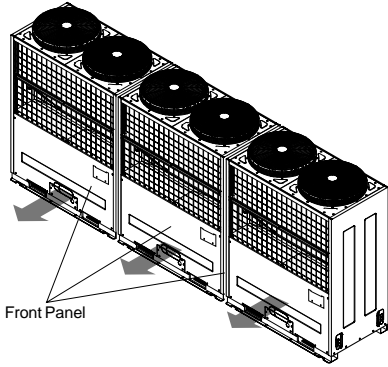

- Connect communication line between master and slave outdoor unit through the terminal block.
- Connect communication lines between outdoor unit and indoor units through the terminal block.
- When the central control system is connected to the outdoor unit, a dedicated PCB must be connected between them.
- When connecting communication line between outdoor unit and indoor units with shielded wire, connect the shield ground to the earth screw.

ENGLISH

WARNING

The temperature sensor for outdoor air should not be exposed to direct sunlight.

- Provide an appropriate cover to intercept direct sunlight.

UW1 Chassis(460V)

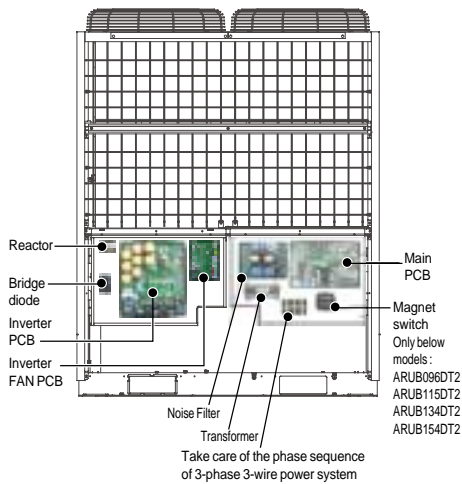

UW1 Chassis(208/230V)

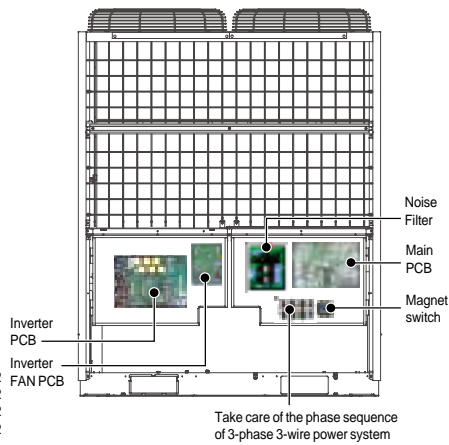

Communication and Power Lines

1) Communication cable

- Types : shielding wire CVVS or CPEVS
- Cross section : over 1.25mm²
- Insulation material : PVC
- Maximum allowable temperature: 140°F
- Maximum allowable line length: under 1,000m(3,280ft)

2) Remote control cable

- Types : 3-core cable

3) Simple central control cable

- Types : 4-core cable (Shielding wire)
- Cross section : over 0.75mm²
- Insulation material : PVC

4) Separation of communication and power lines

- If communication and power lines are run alongside each other then there is a strong likelihood of operational faults developing due to interference in the signal wiring caused by electrostatic and electromagnetic coupling.

The tables below indicates our recommendation as to appropriate spacing of communication and power lines where these are to be run side by side

Current capacity of power line		Spacing
100V or more	10A	300mm(11-13/16 inch)
	50A	500mm(19-11/16 inch)
	100A	1,000mm(39-3/8 inch)
	100A over	1,500mm(59-1/16 inch)

Note:

1. The figures are based on assumed length of parallel cabling up to 100m(328ft). For length in excess of 100m(328ft) the figures will have to be recalculated in direct proportion to the additional length of line involved.
 2. If the power supply waveform continues to exhibit some distortion the recommended spacing in the table should be increased.
- If the lines are laid inside conduits then the following point must also be taken into account when grouping various lines together for introduction into the conduits
 - Power lines(including power supply to air conditioner) and signal lines must not be laid inside the same conduit
 - In the same way, when grouping the power lines and signal lines should not be bunched together.

CAUTION

- If apparatus is not properly earthed then there is always a risk of electric shocks, the earthing of the apparatus must be carried out by a qualified person.
- Use a power wire pipe for the power wiring.

◆ Wiring of Main Power Supply and Equipment Capacity

1. Use a separate power supply for the outdoor unit and indoor unit.
2. Bear in mind ambient conditions (ambient temperature, direct sunlight, rain water, etc.) when proceeding with the wiring and connections.
3. The wire size is the minimum value for metal conduit wiring. The power cord size should be 1 rank thicker taking into account the line voltage drops. Make sure the power-supply voltage does not drop more than 10%.
4. Specific wiring requirements should adhere to the wiring regulations of the region.
5. Power supply cords of parts of appliances for outdoor use should not be lighter than polychloroprene sheathed flexible cord.
6. Don't install an individual switch or electrical outlet to disconnect each of indoor unit separately from the power supply.
7. All the wiring should comply with the local electrical legislations.

WARNING

- Be sure to use specified wires for connections so that no external force is imparted to terminal connections. If connections are not fixed firmly, it may cause heating or fire.
- Be sure to use the appropriate type of overcurrent protection switch. Note that generated overcurrent may include some amount of direct current.

CAUTION

- Some installation site may require attachment of an earth leakage breaker. If no earth leakage breaker is installed, it may cause an electric shock.
- Do not use anything other than breaker and fuse with correct capacity. Using fuse and wire or copper wire with too large capacity may cause a malfunction of unit or fire.

◆ Precautions when laying power wiring

Use round pressure terminals for connections to the power terminal block.

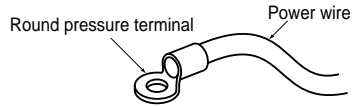

When none are available, follow the instructions below.

- Do not connect wiring of different thicknesses to the power terminal block. (Slack in the power wiring may cause abnormal heat.)
- When connecting wiring which is the same thickness, do as shown in the figure below.

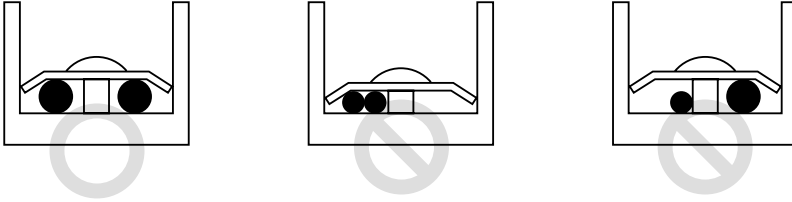

- For wiring, use the designated power wire and connect firmly, then secure to prevent outside pressure being exerted on the terminal block.
- Use an appropriate screwdriver for tightening the terminal screws. A screwdriver with a small head will strip the head and make proper tightening impossible.
- Over-tightening the terminal screws may break them.

CAUTION

When the 400 volt power supply is applied to "N" phase by mistake, replace inverter PCB and transformer in control box.

◆ Example Connection of Communication Cable

■ 1 Outdoor Unit - 3Ø, 208/230V

ENGLISH

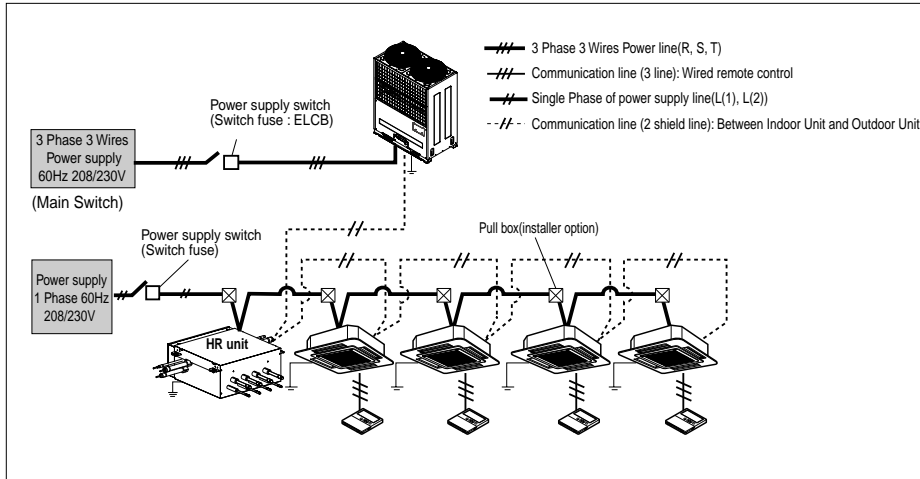

! WARNING

- Indoor Unit ground Lines are required for preventing electrical shock accident during current leakage, Communication disorder by noise effect and motor current leakage (without connection to pipe).
- Don't install an individual switch or electrical outlet to disconnect each of indoor unit separately from the power supply.
- Install the main switch that can interrupt all the power sources in an integrated manner because this system consists of the equipment utilizing the multiple power sources.
- If there exists the possibility of reversed phase, lose phase, momentary blackout or the power goes on and off while the product is operating, attach a reversed phase protection circuit locally. Running the product in reversed phase may break the compressor and other parts.

Between Indoor and Master Outdoor unit

SODU	IDU	INTERNET	DRY1	DRY2	GND	12V	Master Outdoor unit
B	A		B	A			

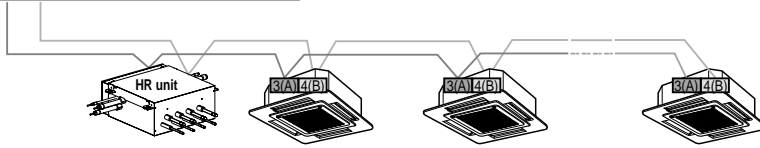

The GND terminal is a 'L' terminal for the central controller, not ground line

◆ Example Connection of Communication Cable

2 Outdoor Units

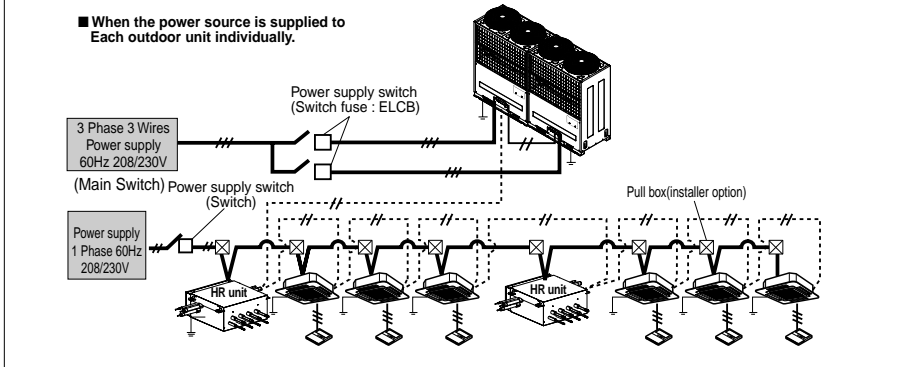
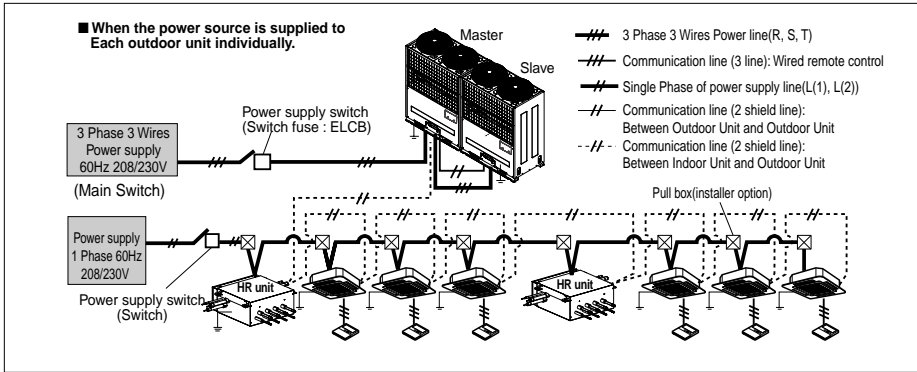

⚠ WARNING

- Indoor Unit ground Lines are required for preventing electrical shock accident during current leakage, Communication disorder by noise effect and motor current leakage (without connection to pipe).
 - Don't install an individual switch or electrical outlet to disconnect each of indoor unit separately from the power supply.
 - Install the main switch that can interrupt all the power sources in an integrated manner because this system consists of the equipment utilizing the multiple power sources.
 - If there exists the possibility of reversed phase, lose phase, momentary blackout or the power goes on and off while the product is operating, attach a reversed phase protection circuit locally.
- Running the product in reversed phase may break the compressor and other parts.

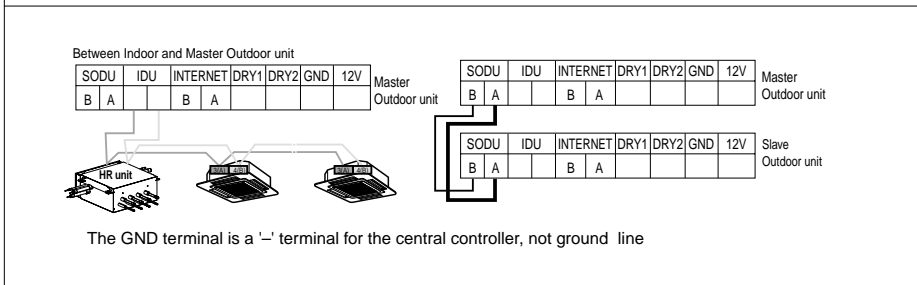

◆ Example Connection of Communication Cable

3 Outdoor Units

ENGLISH

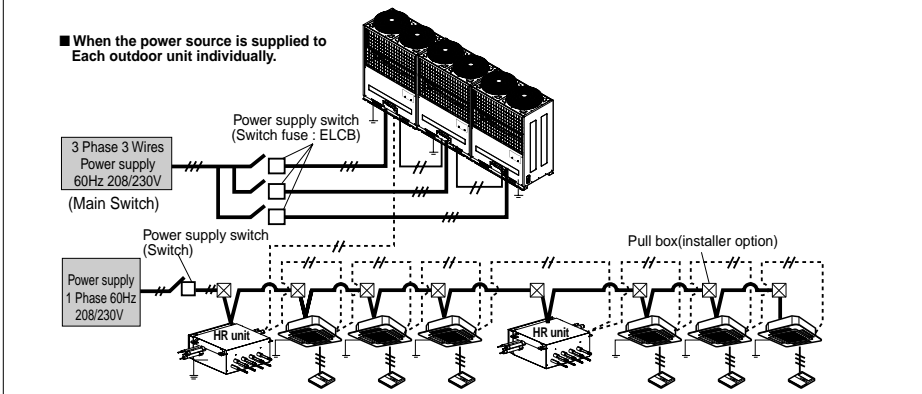
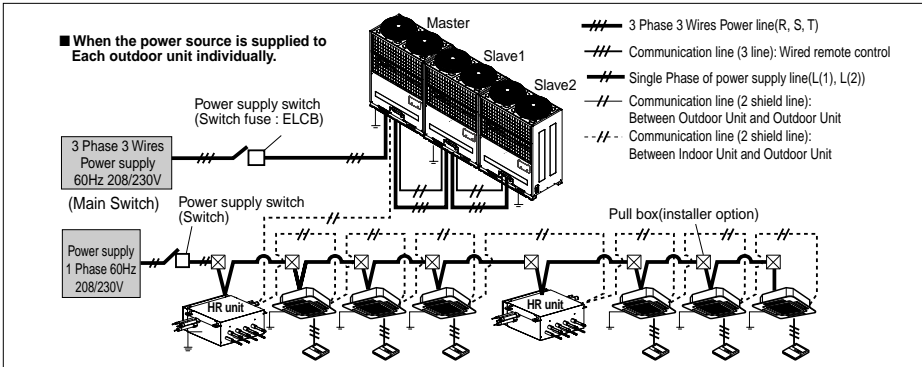

WARNING

- Indoor Unit ground Lines are required for preventing electrical shock accident during current leakage, Communication disorder by noise effect and motor current leakage (without connection to pipe).
- Don't install an individual switch or electrical outlet to disconnect each of indoor unit separately from the power supply.
- Install the main switch that can interrupt all the power sources in an integrated manner because this system consists of the equipment utilizing the multiple power sources.
- If there exists the possibility of reversed phase, lose phase, momentary blackout or the power goes on and off while the product is operating, attach a reversed phase protection circuit locally.

Running the product in reversed phase may break the compressor and other parts.

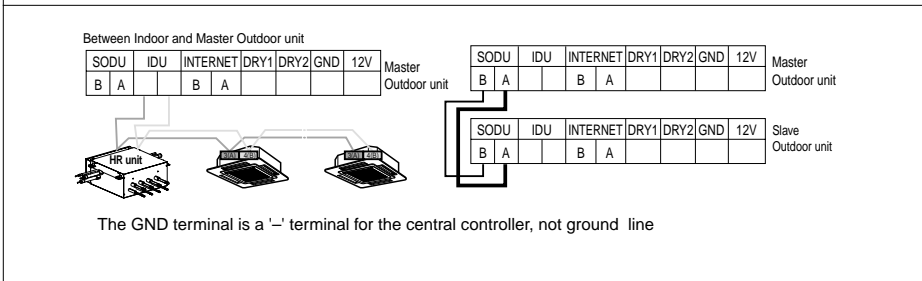

◆ Example Connection of Communication Cable

■ 1 Outdoor Unit - 3Ø, 460V

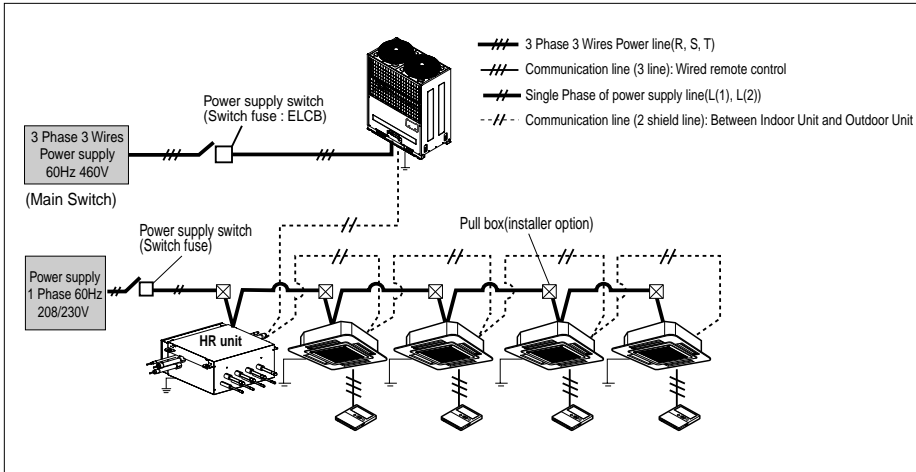

WARNING

- Indoor Unit ground Lines are required for preventing electrical shock accident during current leakage, Communication disorder by noise effect and motor current leakage (without connection to pipe).
- Don't install an individual switch or electrical outlet to disconnect each of indoor unit separately from the power supply.
- Install the main switch that can interrupt all the power sources in an integrated manner because this system consists of the equipment utilizing the multiple power sources.
- If there exists the possibility of reversed phase, lose phase, momentary blackout or the power goes on and off while the product is operating, attach a reversed phase protection circuit locally.
Running the product in reversed phase may break the compressor and other parts.

Between Indoor and Master Outdoor unit

SODU	IDU	INTERNET	DRY1	DRY2	GND	12V
B	A		B	A		

Master Outdoor unit

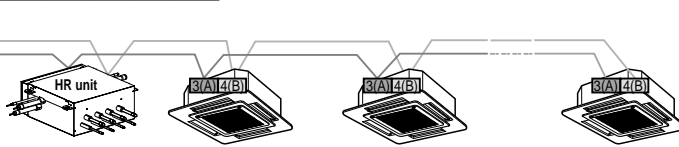

The GND terminal is a 'L' terminal for the central controller, not ground line

◆ Example Connection of Communication Cable

2 Outdoor Units

ENGLISH

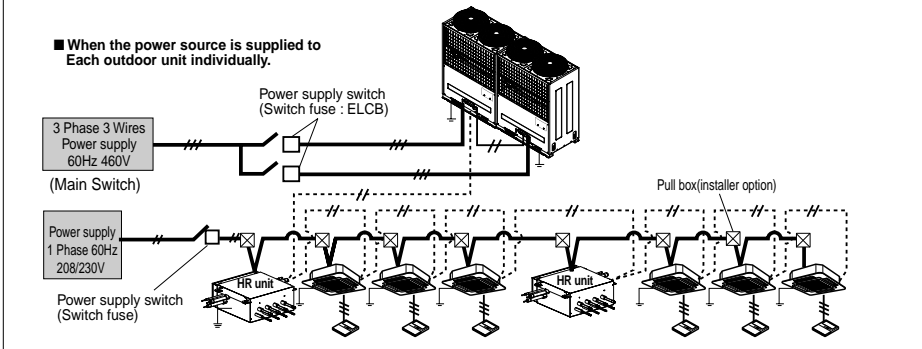
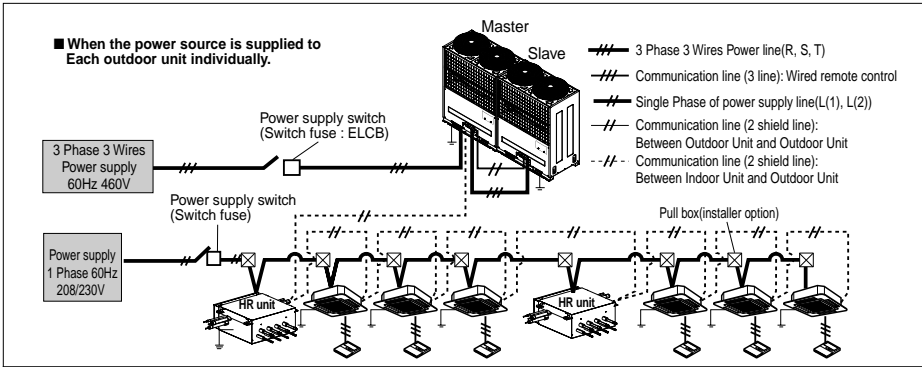

WARNING

- Indoor Unit ground Lines are required for preventing electrical shock accident during current leakage, Communication disorder by noise effect and motor current leakage (without connection to pipe).
- Don't install an individual switch or electrical outlet to disconnect each of indoor unit separately from the power supply.
- Install the main switch that can interrupt all the power sources in an integrated manner because this system consists of the equipment utilizing the multiple power sources.
- If there exists the possibility of reversed phase, lose phase, momentary blackout or the power goes on and off while the product is operating, attach a reversed phase protection circuit locally. Running the product in reversed phase may break the compressor and other parts.

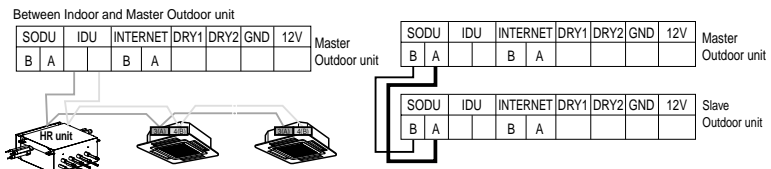

The GND terminal is a '-' terminal for the central controller, not ground line

◆ Example Connection of Communication Cable

3 Outdoor Units

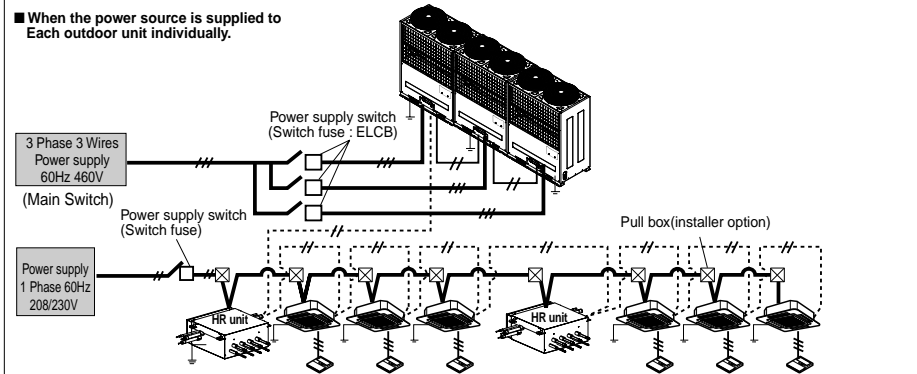
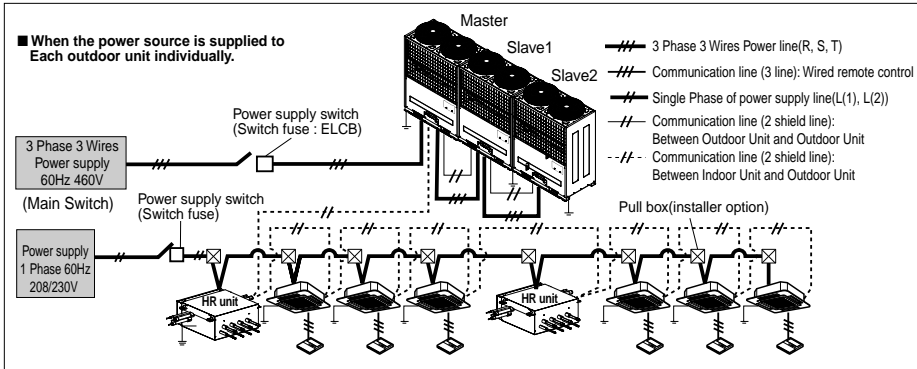

⚠ WARNING

- Indoor Unit ground Lines are required for preventing electrical shock accident during current leakage, Communication disorder by noise effect and motor current leakage (without connection to pipe).
- Don't install an individual switch or electrical outlet to disconnect each of indoor unit separately from the power supply.
- Install the main switch that can interrupt all the power sources in an integrated manner because this system consists of the equipment utilizing the multiple power sources.
- If there exists the possibility of reversed phase, lose phase, momentary blackout or the power goes on and off while the product is operating, attach a reversed phase protection circuit locally.
Running the product in reversed phase may break the compressor and other parts.

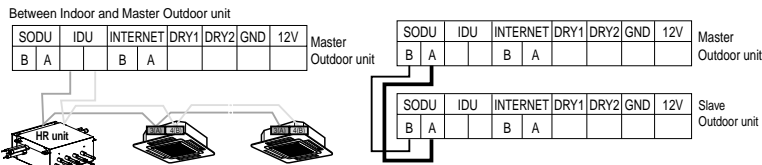

The GND terminal is a 'L' terminal for the central controller, not ground line

◆ Example Connection of Communication Cable

[BUS type]

- Connection of communication cable must be installed like below figure between indoor unit to outdoor unit.



[STAR type]

- Abnormal operation can be caused by communication defect, when connection of communication cable is installed like below figure(STAR type).

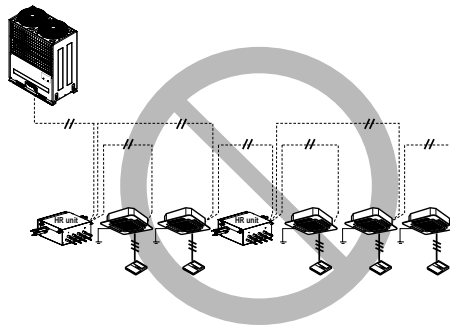

ENGLISH

HR Unit PCB

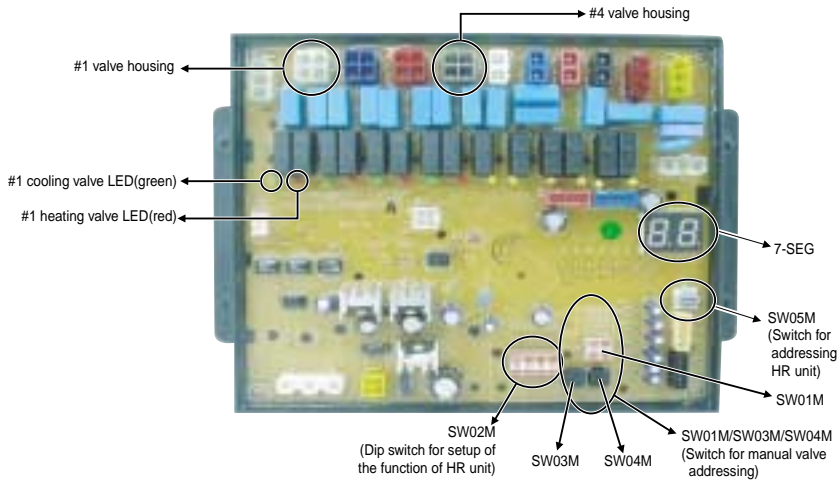

Switch for setup of HR Unit

1. Main function of SW02M

ON S/W	Selection
No.1	Method for addressing valves of an HR unit (Auto/Manual)
No.2	Model of HR unit
No.3	Model of HR unit
No.4	Valve group setting
No.5	Valve group setting
No.6	Valve group setting
No.7	Use only in factory production (preset to "OFF")
No.8	Use only in factory production (preset to "OFF")



SW02M

1) Selection of the method for addressing valves of an HR unit (Auto/Manual)

<p>Switch No.1 Off</p> <p>Auto</p>	<p>Switch No.1 On</p> <p>Manual</p>
---	--

2) Selection of the model of the HR unit

ENGLISH

	<p>(For 2 rooms) PRHR020A</p>	<p>(For 3 rooms) PRHR030A</p>	<p>(For 4 rooms) PRHR040A</p>
Initial Setting			
1 room Connected			
2 rooms Connected			
3 rooms Connected			
4 rooms Connected			

* Each model is shipped with the switches No.2 and No.3 pre-adjusted as above in the factory.

! WARNING

- If you want to use a PRHR030A for 2 rooms HR unit after closing the 3rd pipes, set the dip switch for 2 rooms HR unit.
- If you want to use a PRHR030A for 3 rooms HR unit after closing the 4th pipes, set the dip switch for 3 rooms HR unit.
- If you want to use a PRHR040A for 2 rooms HR unit after closing the 3rd and 4th pipes, set the dip switch for 2 rooms HR unit.
- The unused port must be closed with a copper cap, not with a plastic cap.

3) Setting the Valve Group.

	DIP S/W setting	Example
Not control		
No.1, 2 Valve Control		
No.2, 3 Valve Control		
No.3, 4 Valve Control		
No.1, 2 Valve / No.3, 4 Valve Control		

Note:

If the large capacity indoor units are installed, below Y branch pipe should be used

*** Y branch pipe**

[Unit:mm(inch)]

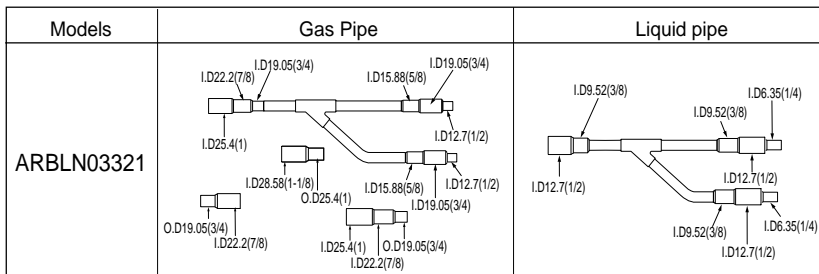

2. SW05M (Rotary S/W for addressing HR unit)

Must be set to '0' when installing only one HR unit.

When installing multiple HR units, address the HR units with sequentially increasing numbers starting from '0'.

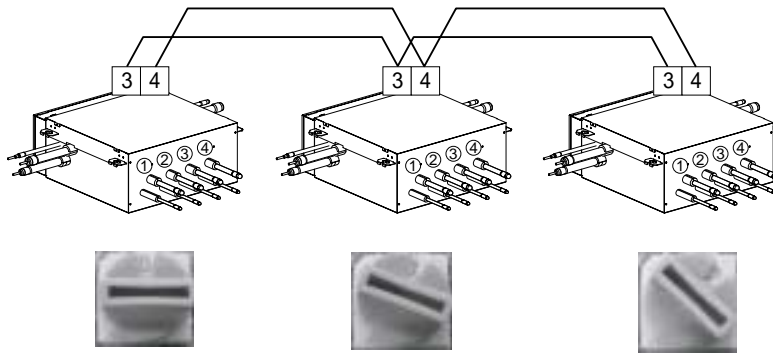

Ex) Installation of 3 HR units



ENGLISH

3. SW01M/SW03M/SW04M (Dip S/W and tact S/W for manual valve addressing)

- Used in manual addressing of the valve in the HR unit
- Set the address of the valve of the HR unit to the central control address of the connected indoor unit.
- SW01M: selection of the valve to address
 SW03M: increase in the digit of 10 of valve address
 SW04M: increase in the last digit of valve address
- Prerequisite for manual valve addressing : central control address of each indoor unit must be preset differently at its wired remote control.

 SW01M	S/W No.	Setup
	No.1	Manual addressing of valve #1
	No.2	Manual addressing of valve #2
	No.3	Manual addressing of valve #3
	No.4	Manual addressing of valve #4
 SW03M	SW03M	Increase in the digit of 10 of valve address
 SW04M	SW04M	Increase in the last digit of valve address

Flow chart for auto addressing for indoor units and HR units

- 1) Auto addressing for indoor unit
- 2) Auto pipe detection
- 3) Manual pipe detection(Execute in case of Auto pipe detection failure)
 - Turn off all the indoor units before auto addressing.
 - If indoor unit is operated, auto addressing would not be completed.

1) Auto addressing for indoor unit

- The address of indoor units would be set by auto addressing

- 1) Wait for 3 minutes after applying power supply (Master and Slave Outdoor unit, Indoor unit).
- 2) Press the switch of the outdoor unit (SW02V) for 5 seconds.
- 3) A "88" is indicated on 7-segment LED of the outdoor unit PCB.
- 4) For completing addressing, 2~7 minutes are required depending on numbers of indoor unit connection set.
- 5) Numbers of indoor unit connection set whose addressing is completed are indicated for 30seconds on 7-segment LED of the outdoor unit PCB.
- 6) After completing addressing, address of each indoor unit is indicated on the wired remote control display window. (CH01, CH02, CH03, CH06: Indicated as numbers of indoor unit connection set).

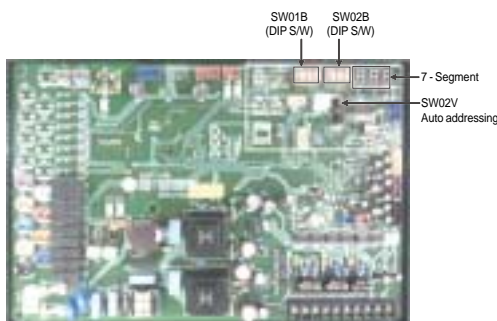

2) Auto pipe detection

- Turn No.1 of SW02M of HR unit PCB off.
- Confirm that the setting of No.2, 3 of SW02M corresponds with the number of indoor units.
- Reset the power of HR unit PCB
- Turn off the No.5 DIP S/W of main unit PCB when outdoor temperature is below 15°C
- Turn on the No.5 DIP S/W of main unit PCB when outdoor temperature is over 15°C
- Reset the power of outdoor unit.
- Wait for 3minutes.
- Press SW01V of the outdoor unit main PCB for 5 Seconds.
- The number of connected HR unit is displayed.
Ex) In case of installing four HR units : 04
- Operated after 88 is displayed on 7-SEG of the outdoor unit main PCB.
- Pipe detection proceed.
- 5~30 minutes are required depending on the number of the indoor units and outdoor temperature.
- The number of the indoor units installed is displayed on 7-SEG of the outdoor unit main PCB for about 1 minute
(For a HR unit, the number of the indoor units connected to each HR unit is displayed.
- '200' is displayed in case of auto pipe detection error, and auto detection is completed after '88' is disappeared.
- ※ Auto pipe detection function : the function that sets connection relationship automatically between the indoor unit and HR unit.

! WARNING

1. Execute auto addressing and auto pipe detection again whenever the indoor PCB and HR unit PCB is replaced.
 - Operation error occurs unless power is applied to the indoor and HR units.
2. Error No.200 occurs if the number of connected indoor units and that of scanned indoor units are different.
3. When auto pipe detection fails, complete it with manual pipe detection (see Manual pipe detection).
4. When auto pipe detection addressing is completed normally, manual pipe detection is not required.
5. If you want to do auto pipe detection again after auto pipe detection fails, do after reset of outdoor unit by all means.

ENGLISH

3) Manual pipe detection

- Enter the central control address into each indoor unit using its wired remote control.
- Turn No.1 of SW02M of HR unit PCB on.
- Reset the power of HR unit PCB.
- On the HR unit PCB, manually set address of each valve of the HR unit to the central control address of the indoor unit connected to the valve.
- Turn No.6 of SW03M of outdoor unit PCB on.
- Reset the power of outdoor unit PCB.
- The number of the indoor unit installed is displayed after about 5 minutes.
Ex) HR → The number of the indoor
- Turn No.6 of SW03M of outdoor unit PCB off.
- Reset the power of outdoor unit PCB, HR unit.
- Manual pipe detection is completed

! WARNING

- In case that central controller is not installed, remain the address data after installer sets central control address as he wants
- In case that central controller is installed, there would be central control address in wired remote control of indoor unit.
- In this case, set the HR unit manual pipe address according to central control address of indoor unit.
- Pipe which is not connected with indoor unit should be set different address with pipe Connected with indoor unit.
(If addresses are piled up, corresponding valve is not working.)
- If you want to change the setting of manual pipe, you should do it on HR unit PCB.
- If an error occurred, it means that manual pipe setting is not completed.

Flow chart of auto-addressing for indoor units

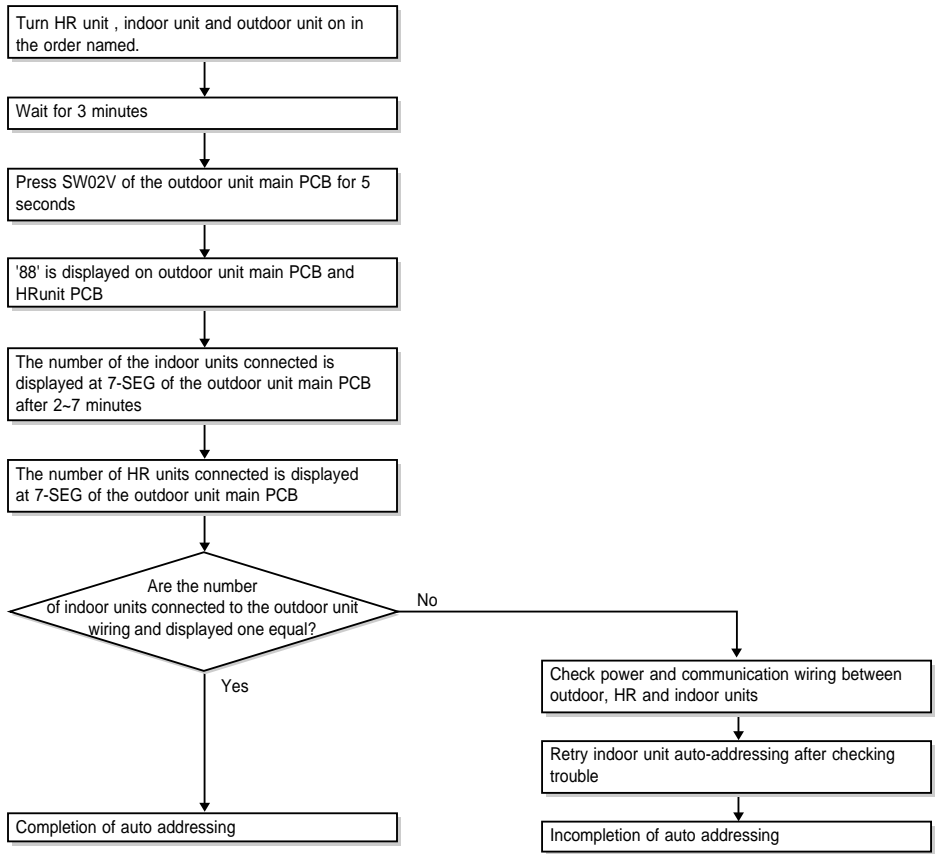

Flow chart of auto addressing for pipe detection

ENGLISH

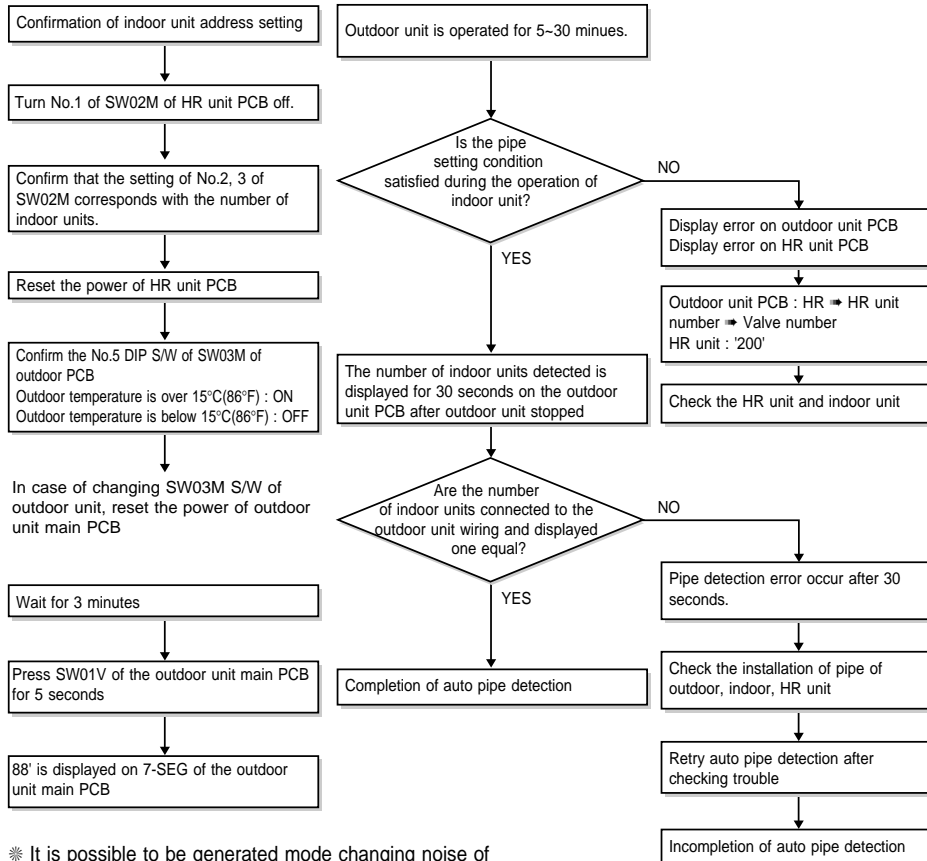

* It is possible to be generated mode changing noise of heating and cooling which is normal. There is no mode changing noise at normal operation.

Flow chart of manual addressing for pipe detection

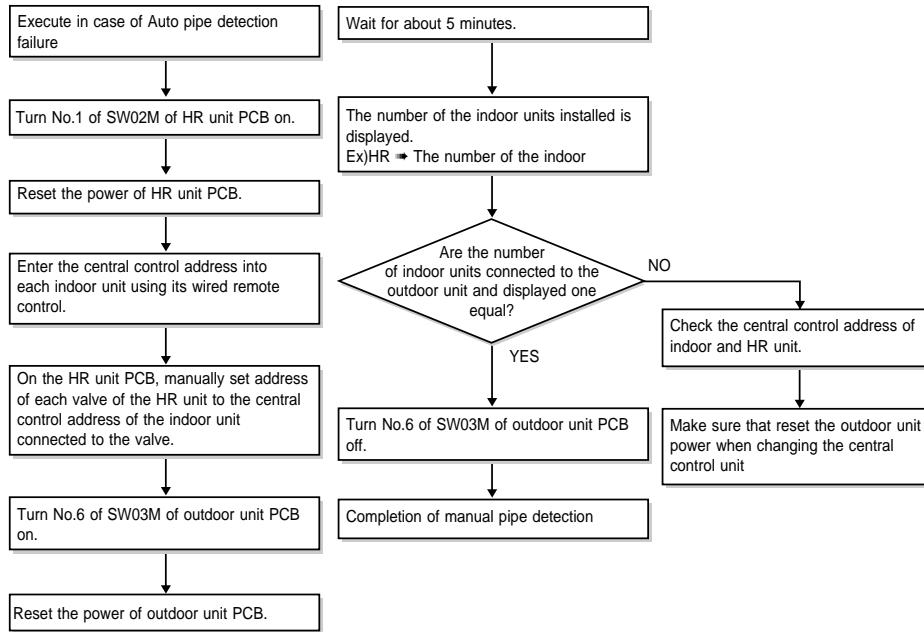

Example of manual valve addressing

(In case that an indoor unit of central control address "11" is connected to a valve #1 of an HR unit)

- Prerequisite for manual valve addressing: central control address of each indoor unit must be preset differently at its wired remote control



ENGLISH

No.	Display and setup	Setup and Contents
1		<ul style="list-style-type: none"> • Operation: None • Display: None
2		<ul style="list-style-type: none"> • Operation: Turn dip S/W No.1 on to address valve #1 • Display: Existing value saved in EEPROM is displayed in 7-SEG.
3		<ul style="list-style-type: none"> • Operation: Set the digit of 10 to the number in Group High data of the wired remote control connected to the corresponding indoor unit to the valve #1 by pressing left tact S/W. • Display: Digit increasing with the times of pressing tact S/W is displayed in left 7-SEG
4		<ul style="list-style-type: none"> • Operation: Set the digit of 1 to the number in Group Low data of the wired remote control connected to the corresponding indoor unit to the valve #1 by pressing right tact S/W. • Display: Digit increasing with the times of pressing tact S/W is displayed in right 7-SEG
5		<ul style="list-style-type: none"> • Operation: Turn dip S/W No.1 off to save the address of valve #1 • Display: "11" displayed in 7-SEG disappears

- Above setup must be done for all HR unit valves.
- The valve that is not connected with any indoor unit should be addressed with any other number than used address numbers of the valves connected with indoor units.
(The valves does not work if the address numbers are same.)

Example of checking valve address

(In case that an indoor unit of central control address "11" is connected to a valve #1 of an HR unit)

No.	Display and Setup	Setup and Contents
1		<ul style="list-style-type: none"> • Operation: Turn dip S/W No.1 on. • Display: "11" is displayed in 7-SEG
2		<ul style="list-style-type: none"> • Operation: Turn dip S/W No.1 on. • 7-SEG disappeared

Identification of Manual Valve ID (Address)

No.	Display and Setup	Setup and Contents
1		<ul style="list-style-type: none"> • Operation: more than 2 dip switches turned on. • Display: "Er" is displayed in 7-SEG

Main PCB

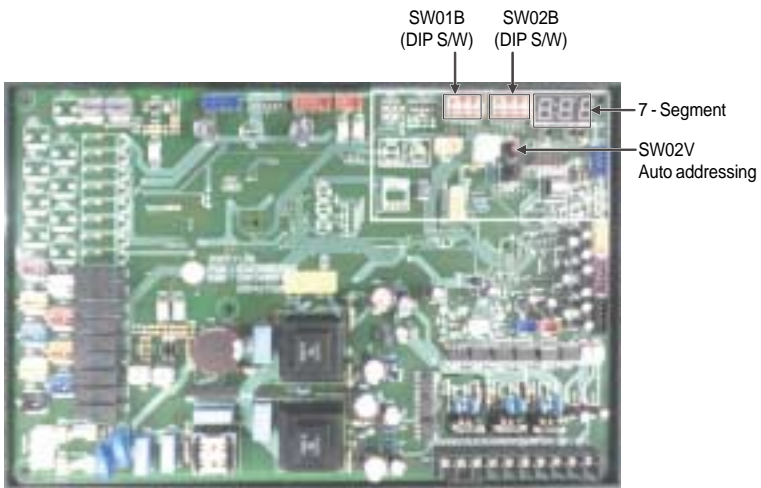

ENGLISH

DIP switch setting

■ Checking according to dip switch setting

1. You can check the setting values of the Master outdoor unit from the 7 segment LED.
The dip switch setting should be changed when the power is OFF.
2. It checks whether the input is properly performed without the bad contact of the dip switch or not

■ Checking the setting of the Master unit

The number is sequentially appeared at the 7 segment in 5 seconds after applying the power. This number represents The setting condition. (For example, represents 3Ø 208/230V 20HP heat pump)
Master model code → Slave1 model code → Total capacity → 2 → 25 → 140

1 ~255 : Master model code
1 ~255 : Slave1 model code
1 ~255 : Slave2 model code } Refer to table code
8~48HP : HP number(sum of Master capacity and slave capacity)
1 : cooling only 2 : heat pump 3 : Sync
25 : Normal
140 : 3Ø 208/230V 160 : 3Ø 460V

Example) 3Ø 208/230V 20HP heat pump
151 → 151 → 20 → 2 → 25 → 140

CAUTION

Product may not properly operate if the relevant DIP switch is not properly setup.

Model Code



3Ø 208/230V	
Model Code	Unit (HP)
190	8
191	10
192	12



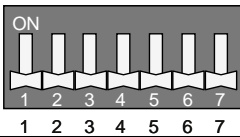
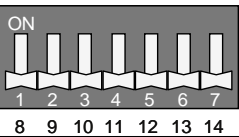
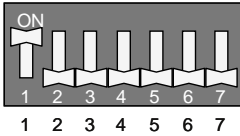
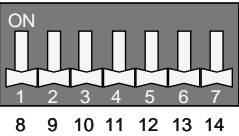
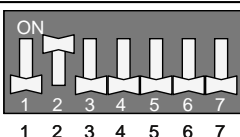
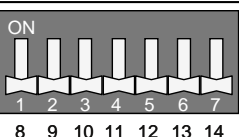
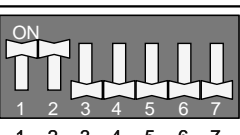
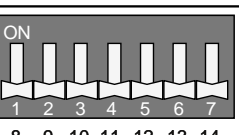

3Ø 460V	
Model Code	Unit (HP)
190	8
191	10
192	12
193	14
194	16

■ Setting the DIP switch

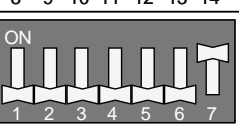
- Set the dip switch with the power turned off. If you change the setting when the power is on, the changed setting is not applied immediately. The changed setting is applied at the moment that the power is on.
- Instant indoor unit checking, data display mode, and forced oil collecting operation are used when the units are running. If you don't have to use those functions after using them, restore the dip switch setting.

1. Settings of Master outdoor unit

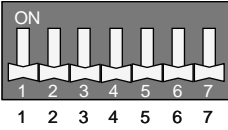
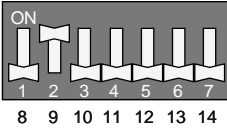
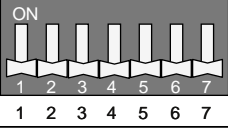
Function	SW01B Setting	SW02B Setting	Remarks
Standard	 1 2 3 4 5 6 7	 8 9 10 11 12 13 14	
Short Pipe Length	 1 2 3 4 5 6 7	 8 9 10 11 12 13 14	
Long Pipe Length	 1 2 3 4 5 6 7	 8 9 10 11 12 13 14	
Longest Pipe Length	 1 2 3 4 5 6 7	 8 9 10 11 12 13 14	
Refrigerant Checking	 1 2 3 4 5 6 7	 8 9 10 11 12 13 14	

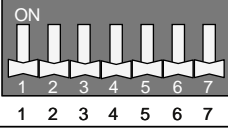
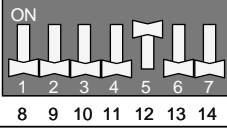
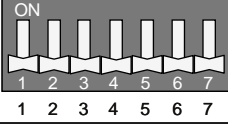
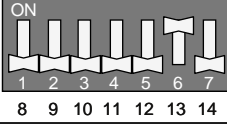
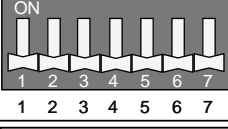
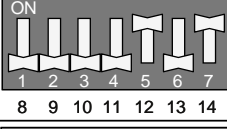
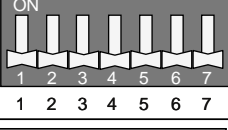
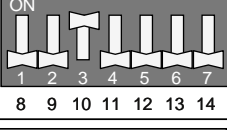
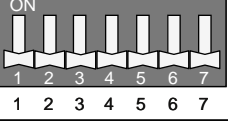
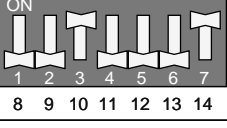
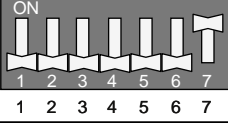
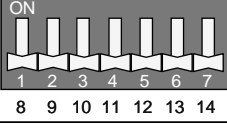
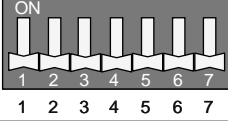
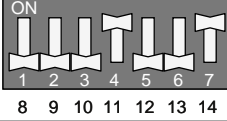
Function	SW01B Setting	SW02B Setting	Remarks
Snow	 <p>1 2 3 4 5 6 7</p>	 <p>8 9 10 11 12 13 14</p>	
Forced Defrosting	 <p>1 2 3 4 5 6 7</p>	 <p>8 9 10 11 12 13 14</p>	
Snow + Forced Defrosting	 <p>1 2 3 4 5 6 7</p>	 <p>8 9 10 11 12 13 14</p>	
Outdoor Unit Fan Low Static Pressure Compensation	 <p>1 2 3 4 5 6 7</p>	 <p>8 9 10 11 12 13 14</p>	
Outdoor Unit Fan High Static Pressure Compensation	 <p>1 2 3 4 5 6 7</p>	 <p>8 9 10 11 12 13 14</p>	
Night silent operation	 <p>1 2 3 4 5 6 7</p>	 <p>8 9 10 11 12 13 14</p>	
Pump Down	 <p>1 2 3 4 5 6 7</p>	 <p>8 9 10 11 12 13 14</p>	
Pump Out	 <p>1 2 3 4 5 6 7</p>	 <p>8 9 10 11 12 13 14</p>	
Forced Oil Return	 <p>1 2 3 4 5 6 7</p>	 <p>8 9 10 11 12 13 14</p>	
Vacuum Mode	 <p>1 2 3 4 5 6 7</p>	 <p>8 9 10 11 12 13 14</p>	

2. Settings of slave outdoor unit

Function	SW01B Setting	SW02B Setting	Remarks
Slave	<p>ON</p> <p>1 2 3 4 5 6 7</p>	<p>ON</p> <p>1 2 3 4 5 6 7</p> <p>8 9 10 11 12 13 14</p>	

3. Settings of corresponding outdoor unit

Function	SW01B Setting	SW02B Setting	Remarks
Inv Back Up	<p>ON</p> <p>1 2 3 4 5 6 7</p>	<p>ON</p> <p>1 2 3 4 5 6 7</p> <p>8 9 10 11 12 13 14</p>	
Unit Back Up	<p>ON</p> <p>1 2 3 4 5 6 7</p>	<p>ON</p> <p>1 2 3 4 5 6 7</p> <p>8 9 10 11 12 13 14</p>	

Group Number setting

Group Number setting for Indoor Units

- ① Confirm the power of whole system(Indoor Unit, Outdoor Unit) is OFF, otherwise turn off.
- ② The communication lines connected to INTERNET terminal should be connected to central control of Outdoor unit with care for their polarity(A → A, B → B)
- ③ Turn the whole system on.
- ④ Set the group and Indoor Unit number with a wired remote control.
- ⑤ To control several sets of Indoor Units into a group, set the group ID from 0 to F for this purpose.

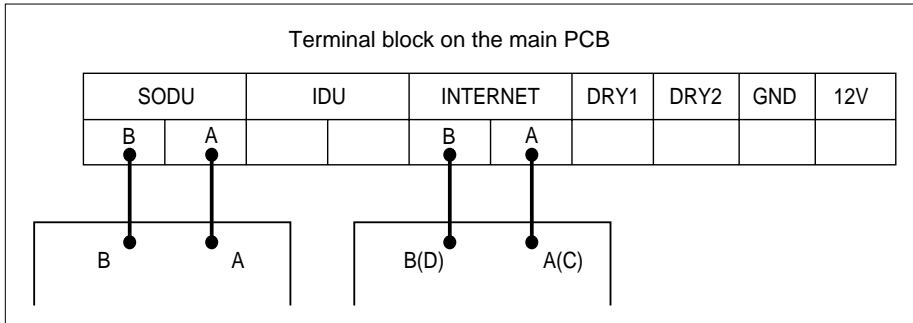

Group recognizing the simple central controller
No.0 group (00~0F)
No.1 group (10~1F)
No.2 group (20~2F)
No.3 group (30~3F)
No.4 group (40~4F)
No.5 group (50~5F)
No.6 group (60~6F)
No.7 group (70~7F)
No.8 group (80~8F)
No.9 group (90~9F)
No. A group (A0~AF)
No. B group (B0~BF)
No. C group (C0~CF)
No. D group (D0~DF)
No. E group (E0~EF)
No. F group (F0~FF)

! WARNING

- Valve address and central control address of its corresponding indoor unit should be set identical in manual addressing.

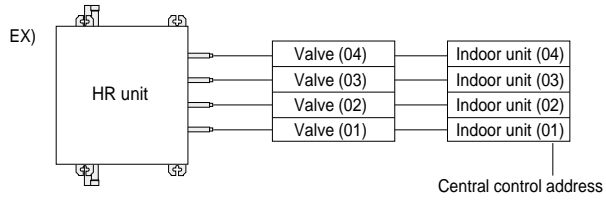

ENGLISH

Test Run

Checks Before Test Run

1	Check to see whether there is any refrigerant leakage, and slack of power or communication cable.
2	<p>Confirm that 500 V megger shows 2.0 MΩ or more between power supply terminal block and ground. Do not operate in the case of 2.0 MΩ or less.</p> <p>NOTE: Never carry out megaohm check over terminal control board. Otherwise the control board would be broken.</p> <p>Immediately after mounting the unit or after leaving it turned off for an extended length of time, the resistance of the insulation between the power supply terminal board and the ground may decrease to approx. 2 MΩ as a result of refrigerant accumulating in the internal compressor. If the insulation resistance is less than 2 MΩ, turning on the main power supply and energizing the crankcase heater for more than 6 hours will cause the refrigerant to evaporate, increasing the insulation resistance.</p>
3	<p>Check if Liquid pipe, High Pressure Gas, Low Pressure Gas are fully opened</p> <p>NOTE: Be sure to tighten caps.</p>
4	<p>Check if there are any problems in automatic addressing or not:</p> <p>Check and confirm that there are no error messages in the display of indoor units or remote controls and LED in outdoor units.</p>



CAUTION

when cutting main power of the Multi V

- Always apply main power of the outdoor unit during use of product
- Always apply power before 6 hours to heat the crank case heater where performing test run after installation of product. It may result in burning out of the compressor if not preheating the crank case with the electrical heater for more than 6 hours.(In case of the outdoor temperature below 10°C(50°F))

How to Cope with Test Run Abnormality

The phenomena from main component failure

Component	Phenomenon	Cause	Check method and Trouble shooting
Compressor	Not operating	Motor insulation broken	Check resistance between terminals and chassis
	Stop during running	Motor insulation failure	Check resistance between terminals and chassis
Outdoor fan	High pressure error at cooling	Motor failure, Bad ventilation around outdoor heat exchanger	Check the outdoor fan operation after being turned the outdoor units off for some time. Remove obstacles around the outdoor units
Outdoor EEV	Heating failure, frequent defrosting	Bad connector contact	Check connector
	No operating sound at applying power	Coil failure	Check resistance between terminals
	Heating failure, Frozen outdoor heat exchanger part	EEV clogged	Service necessary
	Low pressure error or discharge temperature error	EEV clogged	Service necessary

When system fault occurs, the error code is displayed at indoor unit display or remote control display, the trouble shooting guide is in the service manual

Sensor Checking Function

Note 1)

Sensor checking function judges whether the current temperature of indoor and outdoor unit sensors is right or not. -3 indoor temperature sensors, 9 outdoor temperature sensors, 2 outdoor pressure sensors.

It is used for judging sensor abnormality. Note 2)

Note

1. Sensor checking function is used with Refrigerant Checking and Refrigerant Auto Charging.
2. Check abnormal sensor
3. It is displayed at the LED on the main PCB at each step.
4. Refer to the next page for sensor error code part

Caution

1. Confirm auto addressing has been performed (Check installed number of IDU).
2. The error can be displayed even if the sensor is normal according to installation and temperature condition. If error occurs, check the sensor and judge abnormality.

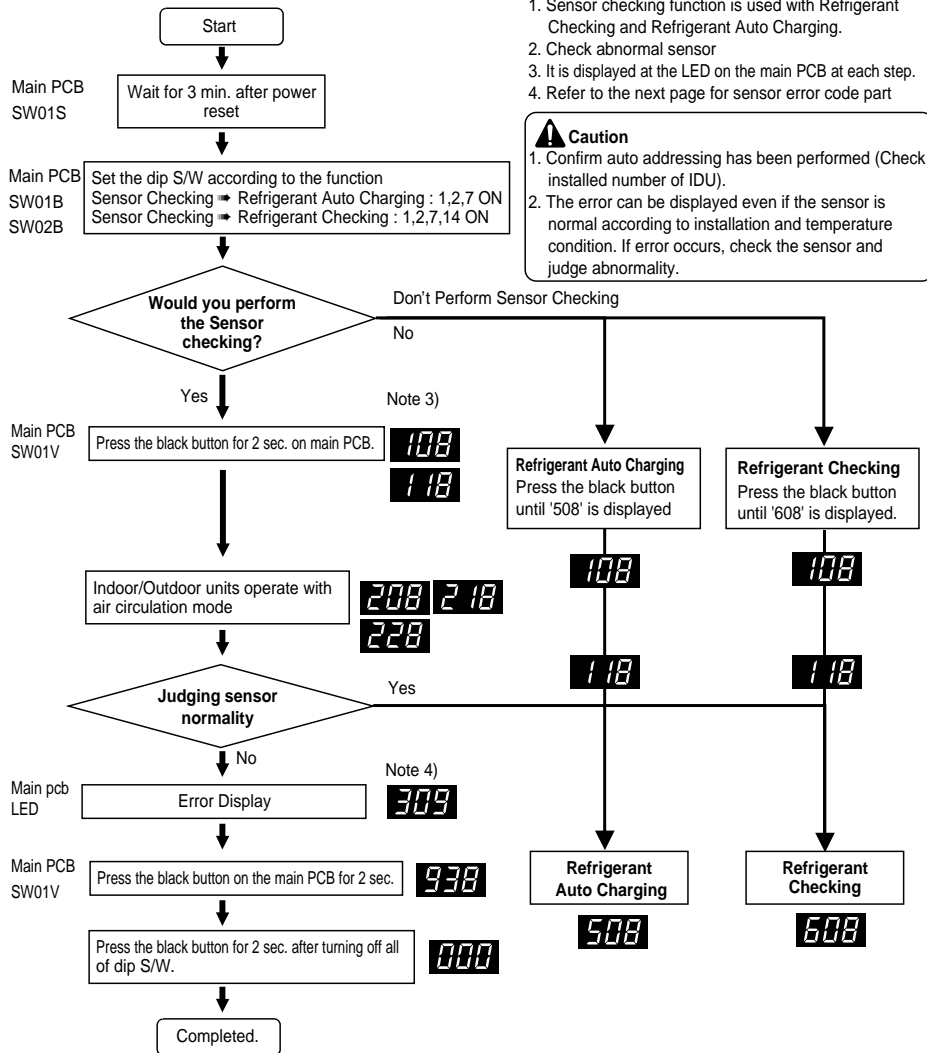

Sensor Check Error Code Display

In case error occurs during sensor checking process, error display is as shown below.
 Following contents are displayed one after the other on the main PCB of master outdoor unit.

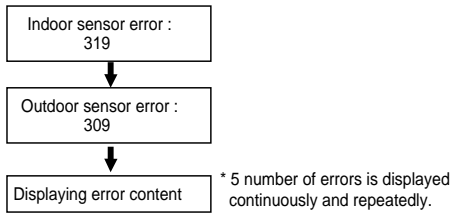

Displaying error content

■ Indoor unit error display

1. 1st and 2nd number represents indoor unit number.
 2. Last number represents sensor.

- 1: Pipe inlet temperature sensor
- 2: Pipe outlet temperature sensor
- 3: Air temperature sensor

■ Displaying outdoor unit error

1. 1st and 2nd number represents error content(code).
 2. Last number represents outdoor unit number.

- 1 : Master
- 2 : Slave

* Indoor unit number follows auto addressing number.
 (To check the LGMV Data)

1	Outdoor Air Temperature
2	Heat Exchanger 1
3	Heat Exchanger 2
4	Inverter Comp. Discharge Temperature
5	Const. Speed. Comp. Discharge Temperature
6	Suction Temperature
7	Liquid Pipe Temperature
8	SC pipe in
9	SC pipe out
10	High Pressure Sensor
11	Low Pressure Sensor

ex) Indoor unit No. 2 Pipe inlet temperature sensor error



ex) Outdoor Master Unit Liquid pipe temperature sensor error



ex) IDU No.2 Pipe inlet temperature sensor error and Master ODU suction temperature sensor, Slave 3 high pressure sensor error

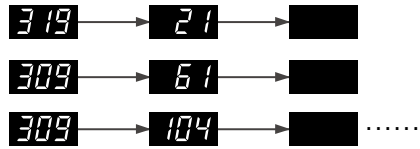

⚠ Caution

1. Up to 5 number of errors is displayed continuously and repeatedly. In case 5 error occurs, again perform sensor checking after solving errors.
2. IDU in which error occurred operates air circulation mode.

Refrigerant Auto Charging Function

This function charges appropriate amount of refrigerant automatically through cycle operation. It can be used when refrigerant amount isn't certain because of SVC and leakage.

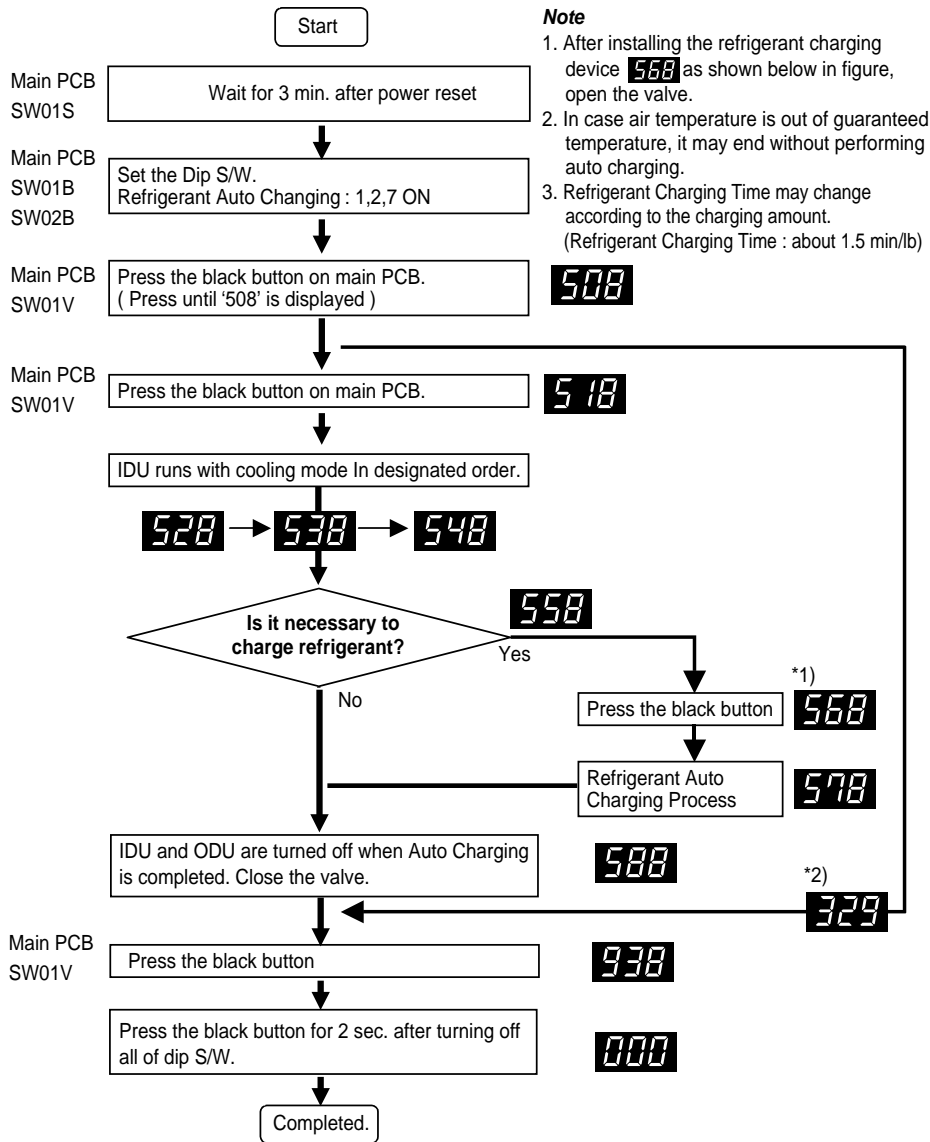

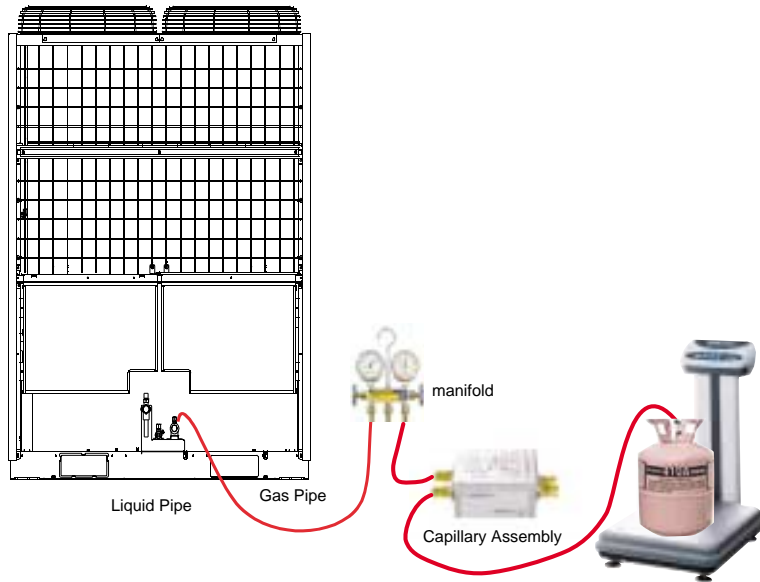

Procedure

1. Arrange manifold, capillary assembly, refrigerant vessel and scale
2. Connect manifold to the gas pipe service valve of ODU as shown in the figure.
3. Connect manifold and Capillary tube.
Use designated capillary assembly only.
If designated capillary assembly isn't used, the system may get damaged.
4. Connect capillary and refrigerant vessel.
5. Purge hose and manifold.
6. After **568** is displayed, open the valve and charge the refrigerant

■ Error contents about auto refrigerant charging function

1. **329** : Temperature Range Error (In case that IDU or ODU is out of range)
2. **339** : Low Pressure Descent Error (In case the system runs at low pressure limit for over 10 minutes)
3. **349** : Judging rapid refrigerant inflow (In case the liquid refrigerant flows in because of not using designated Capillary Assembly)
4. **359** : Instability Error(In case the high/low pressure target doesn't get satisfied for some time after the starting operation)

⚠ CAUTION

1. Guaranteed temperature range (Error will occur if temperature is out of range)
IDU : 20°C(68°F) ~ 32°C(90°F)
ODU : 0°C(32°F) ~ 43°C (77°F)
2. For refrigerant charging, use designated device only. (Capillary Assem Set)
3. Set the IDU wired remote controller temperature sensing mode as IDU
4. Be careful that IDU should not be thermo off.

Refrigerant Checking Function

1. This function charges appropriate amount of refrigerant automatically through cycle operation.
2. This function judges refrigerant leakage and overcharging.
3. It can be used with refrigerant auto charging function.

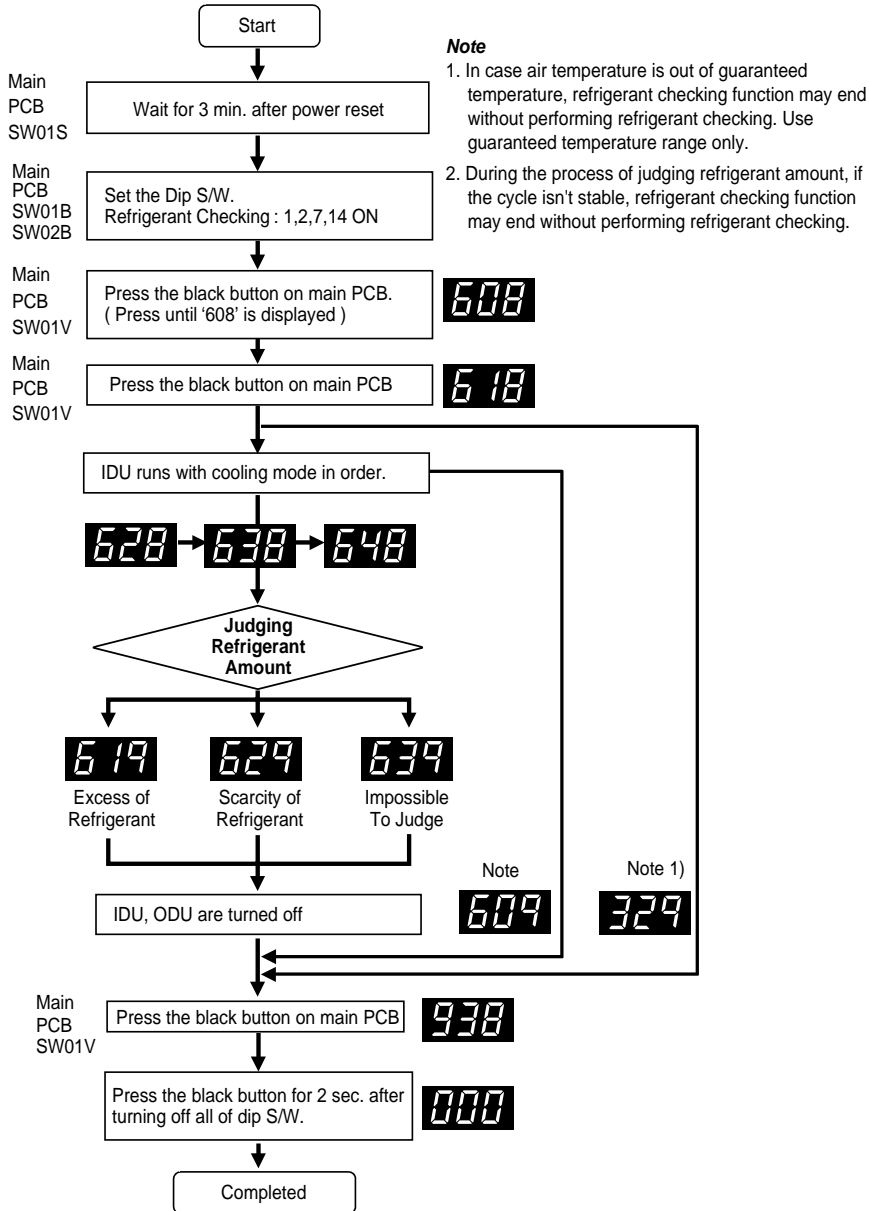

! CAUTION

1. **Guaranteed Temperature range**(Error occurs out of guaranteed temperature range)
IDU : 20~32°C(68~90°F)
ODU : 10~38°C(50~100.4°F)
2. Set IDU wired remote controller temperature sensor setting as 'IDU'.
3. Make certain that IDU doesn't run with thermo off mode during operation.

[Error contents about auto refrigerant charging function]

1. **329** : Temperature Range Error (In case that IDU or ODU is out of range)
2. **609** : System Unstable Error (In case, After 45 min operating the system, it does not be stable)

How to Cope with Result of Refrigerant checking

1. If the temperature is not in guaranteed Temperature range, the system will not execute Refrigerant checking and the system will be OFF.
2. **Excess of Refrigerant(619)**
After remove the 20% of calculated total refrigerant, recharge the refrigerant by using Refrigerant Auto Charging Function.
3. **Scarcity of Refrigerant(629)**
Charge the refrigerant by using Refrigerant Auto Charging Function.
4. **Impossible to Judge(639)**
IF the system is not in order, check the other problem except refrigerant.

Night silent operation Function

In cooling mode, this function makes the ODU fan operate at low RPM to reduce the fan noise of ODU at night which has low cooling load.

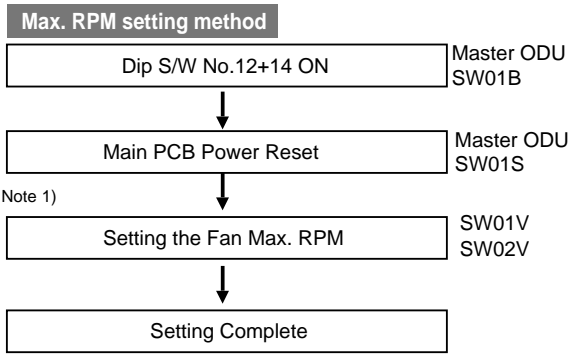

Example of Max. RPM Setting

Fan Max. RPM : Step 1

- Night silent operation start
→ 8 hours after max. ODU temp. sensing, the fan max. RPM is operated setting RPM.
- Night silent operation end
→ 9 hours after Night silent operation is started, the function should be stopped automatically.

CAUTION

1. Request installer to set the function during installation.
2. In case the function is not used, set the dip S/W OFF and reset the power.
3. If ODU RPM changes, cooling capacity may go down.

[Note]

1. Select appropriate RPM referencing noise table.

Step	Setting		Fan Max RPM	Judgment (hr)	Operation (hr)
	Black button	Red button			
1	1 time	1 time	510	8	9
2	2 times	1 time	510	6.5	10.5
3	3 times	1 time	510	5	12
4	4 times	1 time	450	8	9
5	5 times	1 time	450	6.5	10.5
6	6 times	1 time	450	5	12
7	7 times	1 time	400	8	9
8	8 times	1 time	400	6.5	10.5
9	9 times	1 time	400	5	12

Vacuum Mode

This function is used for creating vacuum in the system after compressor replacement, ODU parts replacement or IDU addition/replacement.

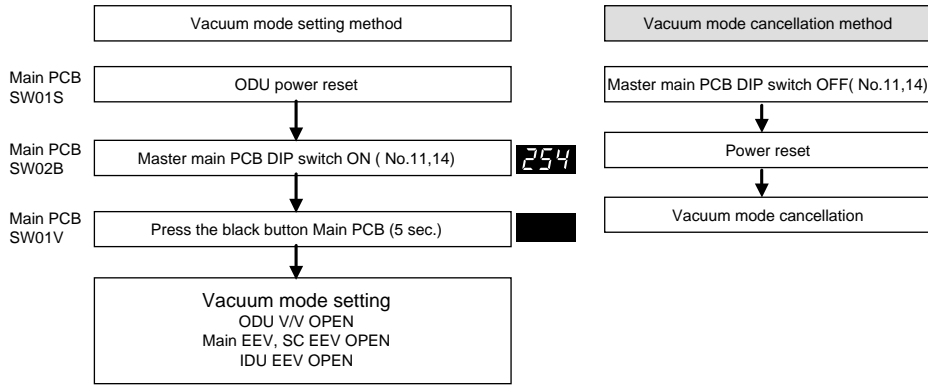

CAUTION
 ODU operation stops during vacuum mode. Compressor can't operate.

ENGLISH

Self-Diagnosis Function

Error Indicator

- This function indicates types of failure in self-diagnosis and occurrence of failure for air condition.
- Error mark is displayed on display window of indoor units and wired remote controller, and 7-segment LED of outdoor unit control board as shown in the table.
- If more than two troubles occur simultaneously, lower number of error code is first displayed.
- After error occurrence, if error is released, error LED is also released simultaneously.

Error Display

1st,2nd LED of 7-segment indicates error number, 3rd LED indicates unit number.

Ex) 211 : No.21 error of master unit

213 : No.21 error of slave

011 → 051 : No.105 error of master unit

			Display	Title	Cause of Error
Indoor unit related error	0	1	-	Air temperature sensor of indoor unit	Air temperature sensor of indoor unit is open or short
	0	2	-	Inlet pipe temperature sensor of indoor unit	Inlet pipe temperature sensor of indoor unit is open or short
	0	3	-	Communication error : wired remote controller ↔ indoor unit	Failing to receive wired remote controller signal in indoor unit PCB
	0	4	-	Drain pump	Malfunction of drain pump
	0	5	-	Communication error : outdoor unit ↔ indoor unit	Failing to receive outdoor unit signal in indoor unit PCB
	0	6	-	Outlet pipe temperature sensor of indoor unit	Outlet pipe temperature sensor of indoor unit is open or short
	0	7	-	Different operation mode	Operation mode between indoor unit and outdoor unit is different
	0	9	-	Serial No.	In case when the serial number marked on EEPROM of Indoor unit is 0 or FFFFFFFF
	1	0	-	Poor fan motor operation	Disconnecting the fan motor connector/Failure of indoor fan motor lock
	1	1	-	Communication error: indoor unit → main PCB of outdoor.	When the addressing signal doesn't respond for 3mins. suddenly, while the indoor unit gets the calling signal from the outdoor unit,
Outdoor unit related error	2	1	1	Master Outdoor Unit Inverter Compressor IPM Fault	Master Outdoor Unit Inverter Compressor Drive IPM Fault
			2	Slave1 Outdoor Unit Inverter Compressor IPM Fault	Slave1 Outdoor Unit Inverter Compressor Drive IPM Fault
			3	Slave2 Outdoor Unit Inverter Compressor IPM Fault	Slave2 Outdoor Unit Inverter Compressor Drive IPM Fault
	2	2	1	Inverter Board Input Over Current(RMS) of Master Outdoor Unit	Master Outdoor Unit Inverter Board Input Current excess (RMS)
			2	Inverter Board Input Over Current(RMS) of Slave1 Outdoor Unit	Slave1 Outdoor Unit Inverter Board Input Current excess (RMS)
			3	Inverter Board Input Over Current(RMS) of Slave2 Outdoor Unit	Slave2 Outdoor Unit Inverter Board Input Current excess (RMS)
	2	3	1	Master Outdoor Unit Inverter Compressor DC link Low Voltage	DC charging is not performed at Master Outdoor Unit after starting relay turn on.
			2	Slave1 Outdoor Unit Inverter Compressor DC link Low Voltage	DC charging is not performed at Slave1 Outdoor Unit after starting relay turn on.
			3	Slave2 Outdoor Unit Inverter Compressor DC link Low Voltage	DC charging is not performed at Slave2 Outdoor Unit after starting relay turn on.

			Display	Title	Cause of Error
Outdoor unit related error	2	4	1	Master Outdoor Unit High Pressure Switch	System is turned off by Master Outdoor Unit high pressure switch.
			2	Slave1 Outdoor Unit High Pressure Switch	System is turned off by slave1 Outdoor Unit high pressure switch.
			3	Slave2 Outdoor Unit High Pressure Switch	System is turned off by slave2 Outdoor Unit high pressure switch.
	2	5	1	Master Outdoor Unit Input Voltage High/Low Voltage	Master Outdoor Unit input voltage is over 487V or below 270V
			2	Slave1 Outdoor Unit Input Voltage High/Low Voltage	Slave1 Outdoor Unit input voltage is over 487V or below 270V
			3	Slave2 Outdoor Unit Input Voltage High/Low Voltage	Slave2 Outdoor Unit input voltage is over 487V or below 270V
	2	6	1	Master Outdoor Unit Inverter Compressor Start Failure	The First Start Failure by Master Outdoor Unit Inverter Compressor Abnormality
			2	Slave1 Outdoor Unit Inverter Compressor Start Failure	The First Start Failure by Slave1 Outdoor Unit Inverter Compressor Abnormality
			3	Slave2 Outdoor Unit Inverter Compressor Start Failure	The First Start Failure by Slave2 Outdoor Unit Inverter Compressor Abnormality
	2	8	1	Master Outdoor Unit Inverter DC link High Voltage	System is turned off by Master Outdoor Unit DC Voltage Over Charging
			2	Slave1 Outdoor Unit Inverter DC link High Voltage	System is turned off by Slave1 Outdoor Unit DC Voltage Over Charging
			3	Slave2 Outdoor Unit Inverter DC link High Voltage	System is turned off by Slave2 Outdoor Unit DC Voltage Over Charging
	2	9	1	Master Outdoor Unit Inverter Compressor Over Current	Master Outdoor Unit Inverter Compressor Fault OR Drive Fault
			2	Slave1 Outdoor Unit Inverter Compressor Over Current	Slave1 Outdoor Unit Inverter Compressor Fault OR Drive Fault
			3	Slave2 Outdoor Unit Inverter Compressor Over Current	Slave2 Outdoor Unit Inverter Compressor Fault OR Drive Fault
	3	2	1	Master Outdoor Unit Inverter Compressor High Discharge Temperature	System is turned off by Master Outdoor Unit Inverter Compressor High Discharge Temperature
			2	Slave1 Outdoor Unit Inverter Compressor High Discharge Temperature	System is turned off by Slave1 Outdoor Unit Inverter Compressor High Discharge Temperature
			3	Slave2 Outdoor Unit Inverter Compressor High Discharge Temperature	System is turned off by Slave2 Outdoor Unit Inverter Compressor High Discharge Temperature
	3	3	1	Master Outdoor Unit Constant Speed Compressor High Discharge Temperature	System is turned off by Master Outdoor Unit Constant Speed High Discharge Temperature
			2	Slave1 Outdoor Unit Constant Speed Compressor High Discharge Temperature	System is turned off by Slave1 Outdoor Unit Constant Speed High Discharge Temperature
			3	Slave2 Outdoor Unit Constant Speed Compressor High Discharge Temperature	System is turned off by Slave2 Outdoor Unit Constant Speed High Discharge Temperature
	3	4	1	High Pressure of Master Outdoor Unit	System is turned off by excessive increase of high pressure of Master Outdoor Unit
			2	High Pressure of Slave1 Outdoor Unit	System is turned off by excessive increase of high pressure of Slave1 Outdoor Unit
			3	High Pressure of Slave2 Outdoor Unit	System is turned off by excessive increase of high pressure of Slave2 Outdoor Unit
3	5	1	Low Pressure of Master Outdoor Unit	System is turned off by excessive decrease of low pressure of Master Outdoor Unit	
		2	Low Pressure of Slave1 Outdoor Unit	System is turned off by excessive decrease of low pressure of Slave1 Outdoor Unit	
		3	Low Pressure of Slave2 Outdoor Unit	System is turned off by excessive decrease of low pressure of Slave2 Outdoor Unit	

Test Run

		Display	Title	Cause of Error	
Outdoor unit related error	4	0	1	Master Outdoor Unit Inverter Compressor CT Sensor Fault	Master Outdoor Unit Inverter Compressor CT Sensor open or short
			2	Slave1 Outdoor Unit Inverter Compressor CT Sensor Fault	Slave1 Outdoor Unit Inverter Compressor CT Sensor open or short
			3	Slave2 Outdoor Unit Inverter Compressor CT Sensor Fault	Slave2 Outdoor Unit Inverter Compressor CT Sensor open or short
	4	1	1	Master Outdoor Unit Inverter Compressor Discharge Temperature Sensor Fault	Master Outdoor Unit Inverter Compressor Discharge Temperature Sensor open or short
			2	Slave1 Outdoor Unit Inverter Compressor Discharge Temperature Sensor Fault	Slave1 Outdoor Unit Inverter Compressor Discharge Temperature Sensor open or short
			3	Slave2 Outdoor Unit Inverter Compressor Discharge Temperature Sensor Fault	Slave2 Outdoor Unit Inverter Compressor Discharge Temperature Sensor open or short
	4	2	1	Master Outdoor Unit Low Pressure Sensor Fault	Master Outdoor Unit Low Pressure Sensor open or short
			2	Slave1 Outdoor Unit Low Pressure Sensor Fault	Slave1 Outdoor Unit Low Pressure Sensor open or short
			3	Slave2 Outdoor Unit Low Pressure Sensor Fault	Slave2 Outdoor Unit Low Pressure Sensor open or short
	4	3	1	Master Outdoor Unit High Pressure Sensor Fault	Master Outdoor Unit High Pressure Sensor open or short
			2	Slave1 Outdoor Unit High Pressure Sensor Fault	Slave1 Outdoor Unit High Pressure Sensor open or short
			3	Slave2 Outdoor Unit High Pressure Sensor Fault	Slave2 Outdoor Unit High Pressure Sensor open or short
	4	4	1	Master Outdoor Unit Air Temperature Sensor Fault	Master Outdoor Unit Air Temperature Sensor open or short
			2	Slave1 Outdoor Unit Air Temperature Sensor Fault	Slave1 Outdoor Unit Air Temperature Sensor open or short
			3	Slave2 Outdoor Unit Air Temperature Sensor Fault	Slave2 Outdoor Unit Air Temperature Sensor open or short
	4	5	1	Master Outdoor Unit Heat Exchanger Temperature Sensor (Front side) Fault	Master Outdoor Unit Heat Exchanger Temperature Sensor(Front side) open or short
			2	Slave1 Outdoor Unit Heat Exchanger Temperature Sensor (Front side) Fault	Slave1 Outdoor Unit Heat Exchanger Temperature Sensor (Front side) open or short
			3	Slave2 Outdoor Unit Heat Exchanger Temperature Sensor (Front side) Fault	Slave2 Outdoor Unit Heat Exchanger Temperature Sensor(Front side) open or short
	4	6	1	Master Outdoor Unit Suction Temperature Sensor Fault	Master Outdoor Unit Suction Temperature Sensor open or short
			2	Slave1 Outdoor Unit Suction Temperature Sensor Fault	Slave1 Outdoor Unit Suction Temperature Sensor open or short
			3	Slave2 Outdoor Unit Suction Temperature Sensor Fault	Slave2 Outdoor Unit Suction Temperature Sensor open or short
	4	7	1	Master Outdoor Unit Constant Speed Compressor Discharge Temperature Sensor Fault	Master Outdoor Unit Constant Speed Compressor Discharge Temperature Sensor open or short
			2	Slave1 Outdoor Unit Constant Speed Compressor Discharge Temperature Sensor Fault	Slave1 Outdoor Unit Constant Speed Compressor Discharge Temperature Sensor open or short
			3	Slave2 Outdoor Unit Constant Speed Compressor Discharge Temperature Sensor Fault	Slave2 Outdoor Unit Constant Speed Compressor Discharge Temperature Sensor open or short

		Display	Title	Cause of Error	
Outdoor unit related error	4	8	1	Master Outdoor Unit Heat Exchanger Temperature Sensor (Rear side) Fault	Master Outdoor Unit Heat Exchanger Temperature Sensor (Rear side) open or short
			2	Slave1 Outdoor Unit Heat Exchanger Temperature Sensor (Rear side) Fault	Slave1 Outdoor Unit Heat Exchanger Temperature Sensor (Rear side) open or short
			3	Slave2 Outdoor Unit Heat Exchanger Temperature Sensor (Rear side) Fault	Slave2 Outdoor Unit Heat Exchanger Temperature Sensor (Rear side) open or short
	5	0	1	Omitting connection of R, S, T power of Master Outdoor Unit	Omitting connection of Master outdoor unit
			2	Omitting connection of R, S, T power of Slave1 Outdoor Unit	Omitting connection of Slave1 Outdoor Unit
			3	Omitting connection of R, S, T power of Slave2 Outdoor Unit	Omitting connection of Slave2 Outdoor Unit
	5	1	1	Excessive capacity of indoor units	Excessive connection of indoor units compared to capacity of Outdoor Unit
	5	2	1	Communication error : inverter PCB → Main PCB	Failing to receive inverter signal at main PCB of Master Outdoor Unit
			2	Communication error : inverter PCB → Main PCB	Failing to receive inverter signal at main PCB of Slave1 Outdoor Unit
			3	Communication error : inverter PCB → Main PCB	Failing to receive inverter signal at main PCB of Slave2 Outdoor Unit
	5	3	1	Communication error : indoor unit → main PCB of Outdoor Unit	Failing to receive indoor unit signal at main PCB of Outdoor Unit .
	5	4	1	Reverse connection of R, S, T power of Master Outdoor Unit	Reverse connection or omitting connection of R, S, T power of Master Outdoor Unit
			2	Reverse connection of R, S, T power of Slave1 Outdoor Unit	Reverse connection or omitting connection of R, S, T power of Slave1 Outdoor Unit
			3	Reverse connection of R, S, T power of Slave2 Outdoor Unit	Reverse connection or omitting connection of R, S, T power of Slave2 Outdoor Unit
	5	9	1	Mixing Installation of Sub Outdoor Unit	Mixing Installation of Old Sub Outdoor Unit and New Slave Outdoor Unit
	6	0	1	Inverter PCB EEPROM Error of Master Outdoor Unit	Access Error of Inverter PCB of Master Outdoor Unit
			2	Inverter PCB EEPROM Error of Slave1 Unit	Access Error of Inverter PCB of Slave1 Outdoor Unit
			3	Inverter PCB EEPROM Error of Slave2 Unit	Access Error of Inverter PCB of Slave2 Outdoor Unit
	6	7	1	Master Outdoor Unit Fan Lock	Restriction of Master Outdoor Unit
			2	Slave1 Outdoor Unit Fan Lock	Restriction of Slave1 Outdoor Unit
			3	Slave2 Outdoor Unit Fan Lock	Restriction of Slave2 Outdoor Unit
	7	0	1	Constant CT Sensor Error of Master Outdoor Unit	Constant CT Sensor open or short of Master Outdoor Unit
			2	Constant CT Sensor Error of Slave1 Outdoor Unit	Constant CT Sensor open or short of Slave1 Outdoor Unit
			3	Constant CT Sensor Error of Slave2 Outdoor Unit	Constant CT Sensor open or short of Slave2 Outdoor Unit
7	1	1	PFC CT Sensor Error of Master Outdoor Unit	Master Outdoor Unit PFC CT Sensor open or short	
		2	PFC CT Sensor Error of Slave1 Outdoor Unit	Slave1 Outdoor Unit PFC CT Sensor open or short	
		3	PFC CT Sensor Error of Slave2 Outdoor Unit	Slave2 Outdoor Unit PFC CT Sensor open or short	

		Display	Title	Cause of Error	
Outdoor unit related error	7	3	1	Instant Over Current(Peak) of Master Outdoor Unit PFC	Instant Over Current(Peak) of Master Outdoor Unit PFC
			2	Instant Over Current(Peak) of Slave1 Outdoor Unit PFC	Instant Over Current(Peak) of Slave1 Outdoor Unit PFC
			3	Instant Over Current(Peak) of Slave2 Outdoor Unit PFC	Instant Over Current(Peak) of Slave2 Outdoor Unit PFC
	7	4	1	Master Outdoor Unit 3 Phase Power unbalance	Master Outdoor Unit R-T Phase Difference is over 5A
			2	Slave1 Outdoor Unit 3 Phase Power unbalance	Slave1 Outdoor Unit R-T Phase Difference is over 5A
			3	Slave2 Outdoor Unit 3 Phase Power unbalance	Slave2 Outdoor Unit R-T Phase Difference is over 5A
	7	5	1	Master Outdoor Unit Fan CT Sensor Error	Master Outdoor Unit Fan CT Sensor open or short
			2	Slave1 Outdoor Unit Fan CT Sensor Error	Slave1 Outdoor Unit Fan CT Sensor open or short
			3	Slave2 Outdoor Unit Fan CT Sensor Error	Slave2 Outdoor Unit Fan CT Sensor open or short
	7	6	1	Master Outdoor Unit Fan DC Link High Voltage Error	Master Outdoor Unit Fan DC Link High Voltage Error
			2	Slave1 Outdoor Unit Fan DC Link High Voltage Error	Slave1 Outdoor Unit Fan DC Link High Voltage Error
			3	Slave2 Outdoor Unit Fan DC Link High Voltage Error	Slave2 Outdoor Unit Fan DC Link High Voltage Error
	7	7	1	Master Outdoor Unit Fan Over Current Error	Master Outdoor Unit Fan Current is over 5A
			2	Slave1 Outdoor Unit Fan Over Current Error	Slave1 Outdoor Unit Fan is over 5A
			3	Slave2 Outdoor Unit Fan Over Current Error	Slave2 Outdoor Unit Fan is over 5A
	7	8	1	Master Outdoor Unit Fan Hall Sensor Error	Master Outdoor Unit Fan Hall Sensor open or Short
			2	Slave1 Outdoor Unit Fan Hall Sensor Error	Slave1 Outdoor Unit Fan Hall Sensor open or Short
			3	Slave2 Outdoor Unit Fan Hall Sensor Error	Slave2 Outdoor Unit Fan Hall Sensor open or Short
	7	9	1	Master Outdoor Unit Fan Start Failure Error	Master Outdoor Unit Fan First Position Sensing Failure
			2	Slave1 Outdoor Unit Fan Start Failure Error	Slave1 Outdoor Unit Fan First Position Sensing Failure
			3	Slave2 Outdoor Unit Fan Start Failure Error	Slave2 Outdoor Unit Fan First Position Sensing Failure
	8	6	1	Master Outdoor Unit Main PCB EEPROM Error	Communication Fail Between Master Outdoor Unit Main MICOM and EEPROM or omitting EEPROM
			2	Slave1 Outdoor Unit Main PCB EEPROM Error	Communication Fail Between Slave1 Outdoor Unit Main MICOM and EEPROM or omitting EEPROM
			3	Slave2 Outdoor Unit Main PCB EEPROM Error	Communication Fail Between Slave2 Outdoor Unit Main MICOM and EEPROM or omitting EEPROM
	8	7	1	Master Outdoor Unit Fan PCB EEPROM Error	Communication Fail Between Master Outdoor Unit Fan MICOM and EEPROM or omitting EEPROM
			2	Slave1 Outdoor Unit Fan PCB EEPROM Error	Communication Fail Between Slave1 Outdoor Unit Fan MICOM and EEPROM or omitting EEPROM
			3	Slave2 Outdoor Unit Fan PCB EEPROM Error	Communication Fail Between Slave2 Outdoor Unit Fan MICOM and EEPROM or omitting EEPROM

Display			Title	Cause of Error		
Outdoor unit related error	1	0	4	1	Communication Error Between Master Outdoor Unit and Other Outdoor Unit	Failing to receive Slave Unit signal at main PCB of Master Outdoor Unit
				2	Communication Error Between Slave1 Outdoor Unit and Other Outdoor Unit	Failing to receive master and other Slave Unit signal at main PCB of Slave1 Outdoor Unit
				3	Communication Error Between Slave2 Outdoor Unit and Other Outdoor Unit	Failing to receive master and other Slave Unit signal at main PCB of Slave2 Outdoor Unit
	1	0	5	1	Master Outdoor Unit Fan PCB Communication Error	Failing to receive fan signal at main PCB of master unit.
				2	Slave1 Outdoor Unit Fan PCB Communication Error	Failing to receive fan signal at main PCB of Slave1 unit.
				3	Slave2 Outdoor Unit Fan PCB Communication Error	Failing to receive fan signal at main PCB of Slave2 unit.
	1	0	6	1	Master Outdoor Unit FAN IPM Fault Error	Instant Over Current at Master Outdoor Unit Fan IPM
				2	Slave1 Outdoor Unit FAN IPM Fault Error	Instant Over Current at Slave1 Outdoor Unit Fan IPM
				3	Slave2 Outdoor Unit FAN IPM Fault Error	Instant Over Current at Slave2 Outdoor Unit Fan IPM
	1	0	7	1	Master Outdoor Unit Fan DC Link Low Voltage Error	Master Outdoor Unit Fan DC Link Input Voltage is under 380V
				2	Slave1 Outdoor Unit Fan DC Link Low Voltage Error	Slave1 Outdoor Unit Fan DC Link Input Voltage is under 380V
				3	Slave2 Outdoor Unit Fan DC Link Low Voltage Error	Slave2 Outdoor Unit Fan DC Link Input Voltage is under 380V
	1	1	3	1	Master Outdoor Unit Liquid pipe Temperature Sensor Error	Liquid pipe temperature sensor of Master Outdoor Unit is open or short
				2	Slave1 Outdoor Unit Liquid pipe Temperature Sensor Error	Liquid pipe temperature sensor of slave1 Outdoor Unit is open or short
				3	Slave2 Outdoor Unit Liquid pipe Temperature Sensor Error	Liquid pipe temperature sensor of slave2 Outdoor Unit is open or short
	1	1	4	1	Master Outdoor Unit Subcooling Inlet Temperature Sensor Error	Master Outdoor Unit Subcooling Inlet Temperature Sensor open or short
				2	Slave1 Outdoor Unit Subcooling Inlet Temperature Sensor Error	Slave1 Outdoor Unit Subcooling Inlet Temperature Sensor open or short
				3	Slave2 Outdoor Unit Subcooling Inlet Temperature Sensor Error	Slave2 Outdoor Unit Subcooling Inlet Temperature Sensor open or short
	1	1	5	1	Master Outdoor Unit Subcooling Outlet Temperature Sensor Error	Master Outdoor Unit Subcooling Outlet Temperature Sensor open or short
				2	Slave1 Outdoor Unit Subcooling Outlet Temperature Sensor Error	Slave1 Outdoor Unit Subcooling Outlet Temperature Sensor open or short
				3	Slave2 Outdoor Unit Subcooling Outlet Temperature Sensor Error	Slave2 Outdoor Unit Subcooling Outlet Temperature Sensor open or short
1	5	1	1	Failure of operation mode conversion at Master Outdoor Unit	Pressure unbalance between Outdoor Units	
			2	Failure of operation mode conversion at Slave1 Outdoor Unit	Pressure unbalance between Outdoor Units	
			3	Failure of operation mode conversion at Slave2 Outdoor Unit	Pressure unbalance between Outdoor Units	
1	7	3	1	Master Outdoor Unit Constant Speed Compressor Fault	Comp locking, Check Valve leakage, comp dielectric break down at Master Outdoor Unit	
			2	Slave1 Outdoor Unit Constant Speed Compressor Fault	Comp locking, Check Valve leakage, comp dielectric at Slave1 Outdoor Unit	
			3	Slave2 Outdoor Unit Constant Speed Compressor Fault	Comp locking, Check Valve leakage, comp dielectric at Slave2 Outdoor Unit	

Test Run

				Display	Title	Cause of Error
Outdoor unit related error	1	9	3	1	Excessive increase of Master Outdoor Unit Fan PCB Heat Sink Temperature	Master Outdoor Unit Fan Inverter PCB Temperature is Over 95°C
				2	Excessive increase of Slave1 Outdoor Unit Fan PCB Heat Sink Temperature	Slave1 Outdoor Unit Fan Inverter PCB Temperature is Over 95°C
				3	Excessive increase of Slave2 Outdoor Unit Fan PCB Heat Sink Temperature	Slave2 Outdoor Unit Fan Inverter PCB Temperature is Over 95°C
	1	9	4	1	Master Outdoor Unit Fan PCB Heat Sink Temperature Sensor Error	Master Outdoor Unit Fan PCB Heat Sink Temperature Sensor open or short
				2	Slave1 Outdoor Unit Fan PCB Heat Sink Temperature Sensor Error	Slave1 Outdoor Unit Fan PCB Heat Sink Temperature Sensor open or short
				3	Slave2 Outdoor Unit Fan PCB Heat Sink Temperature Sensor Error	Slave2 Outdoor Unit Fan PCB Heat Sink Temperature Sensor open or short

Caution For Refrigerant Leak

ENGLISH

The installer and system specialist shall secure safety against leakage according to local regulations or standards. The following standards may be applicable if local regulations are not available.

Introduction

Though the R410A refrigerant is harmless and incombustible itself, the room to equip the air conditioner should be large to such an extent that the refrigerant gas will not exceed the limiting concentration even if the refrigerant gas leaks in the room.

Limiting concentration

Limiting concentration is the limit of Freon gas concentration where immediate measures can be taken without hurting human body when refrigerant leaks in the air. The limiting concentration shall be described in the unit of lb/ft³ (Freon gas weight per unit air volume) for facilitating calculation.

Limiting concentration: 0.028 lb/ft³(R410A)

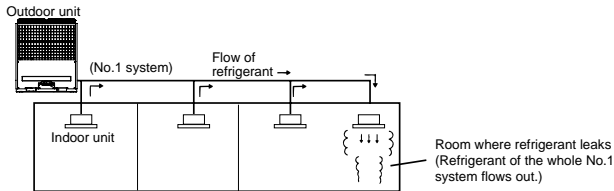

Checking procedure of limiting concentration

Check limiting concentration along following steps and take appropriate measure depending on the situation.

Calculate amount of all the replenished refrigerant (lb) per each refrigerant system.

Amount of replenished refrigerant per one outdoor unit system	+	Amount of additional replenished refrigerant	=	Total amount of replenished refrigerant in refrigerant facility (lb)
Amount of replenished refrigerant at factory shipment		Amount of additionally replenished refrigerant depending on piping length or piping diameter at customer		Note : In case one refrigerant facility is divided into 2 or more refrigerant systems and each system is independent, amount of replenished refrigerant of each system shall be adopted.

Calculate minimum room capacity

Calculate room capacity by regarding a portion as one room or the smaller room.

(1) Without partition

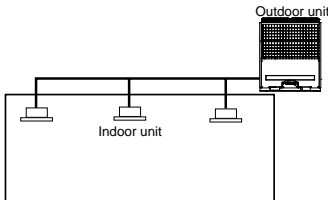

(2) With partition and with opening which serve as passage of air to adjoining room

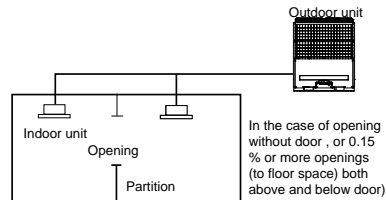

Caution For Refrigerant Leak

(3) With partition and without opening which serve as passage of air to adjoining room

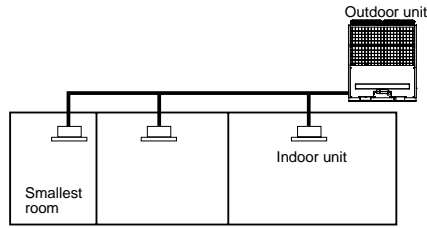

Calculate refrigerant concentration

$$\frac{\text{Total amount of replenished refrigerant in refrigerant facility (lb)}}{\text{Capacity of smallest room where indoor unit is installed (ft}^3\text{)}} = \text{Refrigerant concentration (lb/ft}^3\text{)} \quad \text{(R410A)}$$

In case the result of calculation exceeds the limiting concentration, perform the limiting concentration, perform the same calculations by shifting to the second smallest, and the third smallest rooms until at last the result is below the limiting concentration.

In case the concentration exceeds the limit

When the concentration exceeds the limit, change original plan or take one of the countermeasures shown below:

- **Countermeasure 1**
Provide opening for ventilation.
Provide 0.15% or more opening to floor space both above and below door, or provide opening without door.
- **Countermeasure 2**
Provide gas leak alarm linked with mechanical ventilator.
Reducing the outdoor refrigerant qty.

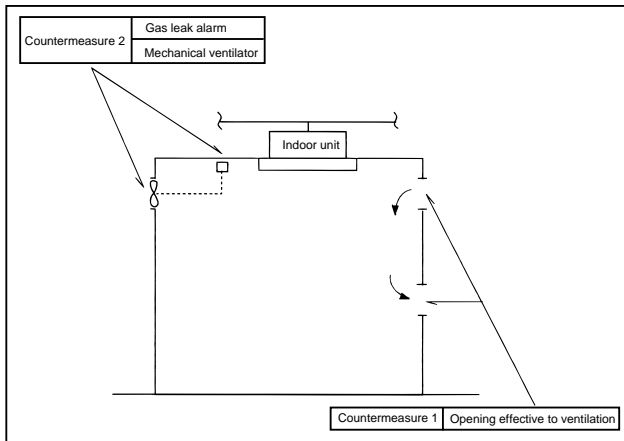

Pay a special attention to the place, such as a basement, etc. where refrigerant can stay, since refrigerant is heavier than air.

Installation guide at the seaside

ENGLISH

CAUTION

1. Air conditioners should not be installed in areas where corrosive gases, such as acid or alkaline gas, are produced.
2. Do not install the product where it could be exposed to sea wind (salty wind) directly. It can result corrosion on the product. Corrosion, particularly on the condenser and evaporator fins, could cause product malfunction or inefficient performance.
3. If outdoor unit is installed close to the seaside, it should avoid direct exposure to the sea wind. Otherwise it needs additional anticorrosion treatment on the heat exchanger.

Selecting the location(Outdoor Unit)

- 1) If the outdoor unit is to be installed close to the seaside, direct exposure to the sea wind should be avoided. Install the outdoor unit on the opposite side of the sea wind direction.

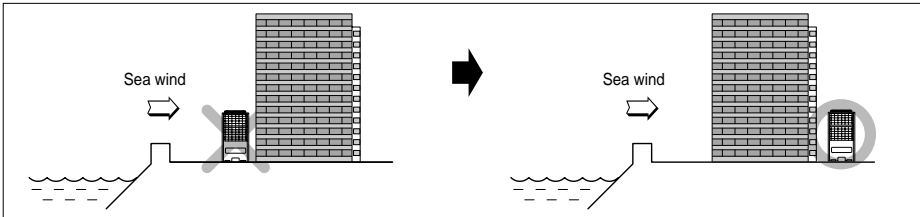

- 2) In case, to install the outdoor unit on the seaside, set up a windbreak not to be exposed to the sea wind.

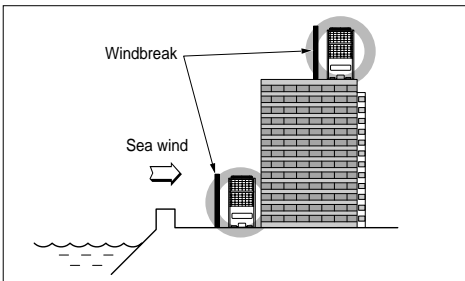

- It should be strong enough like concrete to prevent the sea wind from the sea.
- The height and width should be more than 150% of the outdoor unit.
- It should be keep more than 27.6 inch of space between outdoor unit and the windbreak for easy air flow.

- 3) Select a well-drained place.

1. If you can't meet above guide line in the seaside installation, please contact LG Electronics for the additional anticorrosion treatment.
2. Periodic (more than once/year) cleaning of the dust or salt particles stuck on the heat exchanger by using water



P/No.: MFL46912304

Printed in Korea

After reading this manual, keep it in a place easily accessible to the user for future reference.