



<http://www.lgservice.com>

LG

ENGLISH

FRANÇAIS

ESPAÑOL

LG

Room Air Conditioner

INSTALLATION MANUAL

IMPORTANT

- Please read this instruction manual completely before installing the product.
- When the power cord is damaged, replacement should be performed by authorized personnel only.
- Installation work must be performed in accordance with the national wiring standards by authorized personnel only.
- Please retain this installation manual for future reference after reading it thoroughly.

TABLE OF CONTENTS

Installation Requirements	Required Parts	Required Tools
Safety Precautions3		
Introduction9		
Symbols Ued in This Manual.....9	<input type="checkbox"/> Installation plate	<input type="checkbox"/> Level gauge
Features9	<input type="checkbox"/> Four type "A" screws	<input type="checkbox"/> Screwdriver
	<input type="checkbox"/> Connecting cable	<input type="checkbox"/> Electric drill
		<input type="checkbox"/> Hole core drill(ø70mm(2.76in))
Installation10		
Installation Parts10	<input type="checkbox"/> Pipes: Suction line	<input type="checkbox"/> Flaring tool set
Installation Tools10	Evaporator line	<input type="checkbox"/> Specified torque wrenches
Installation Map.....11	(Refer to page 13)	4.2kg-m, 6.6kg-m
Confirm The Refrigerant12	<input type="checkbox"/> Insulation materials	(different depending on model No.)
Select The Best Location13	<input type="checkbox"/> Additional drain pipe	(Refer to page 17)
Piping Length And Elevation.....14	(Outer Diameter15.5mm(0.61in))	<input type="checkbox"/> SpannerHalf union
How To Mount Installation Plate..15		
Drill a Hole In The Wall.....15		
Flaring Work.....16		
Connecting The Piping.....17		
Connection Of The Drain Hose...22		<input type="checkbox"/> A glass of water
Connection Of Piping -Outdoor...22		<input type="checkbox"/> Screw driver
Connection Of The Cable23		
Checking The Drainage25		<input type="checkbox"/> Hexagonal
Forming The Piping26		wrench(4mm(0.16in))
Air Purging27		<input type="checkbox"/> Gas Leak Detector
Air Purging With Vacuum Pump..27		<input type="checkbox"/> Vacuum pump
Charging.....29	<input type="checkbox"/> Two type "B" screws	<input type="checkbox"/> Manifold Gauge
		<input type="checkbox"/> Owner's manual
Test Running30		<input type="checkbox"/> Thermometer
		<input type="checkbox"/> Remote Control Holder
Installation guide		
at the seaside31		

Safety Precautions

To prevent the injury of the user or other people and property damage, the following instructions must be followed.

- Incorrect operation due to ignoring instruction will cause harm or damage. The seriousness is classified by the following indications.

⚠ WARNING This symbol indicates the possibility of death or serious injury.

⚠ CAUTION This symbol indicates the possibility of injury or damage to properties only.

- The meanings of the symbols used in this manual are as shown below.

	Be sure not to do.
	Be sure to follow the instruction.

⚠ WARNING

■ Installation

Do not use damaged power cords, plugs, or a loose socket.

- There is risk of fire or electric shock.



For electrical work, contact the dealer, seller, a qualified electrician, or an Authorized Service Center.

- There is risk of fire or electric shock.

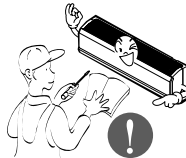

Always use the power plug and socket with the ground terminal.

- There is risk of electric shock.

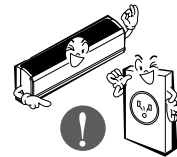

Install the panel and the cover of control box securely.

- There is risk of fire or electric shock.

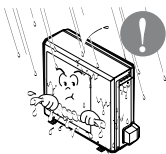

Do not modify or extend the power cord.

- There is risk of fire or electric shock.

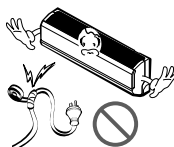

Do not install, remove, or re-install the unit by yourself (customer).

- There is risk of fire, electric shock, explosion or injury.



Be cautious when unpacking and installing the product.

- Shape edges could cause injury. Be especially careful of the sharp edges.

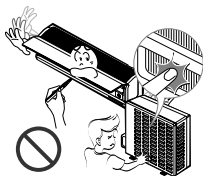

For installation, always contact the dealer or an Authorized Service Center.

- There is risk of fire, electric shock, explosion, or injury.

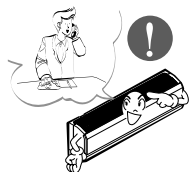

Do not install the product on a defective installation stand.

- It may cause injury, accident, or damage to the product.

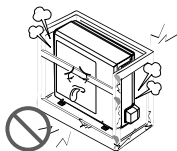

Be sure the installation area does not deteriorate with age.

- If the base collapses, the air conditioner could fall with it, causing property damage, product failure, and personal injury.

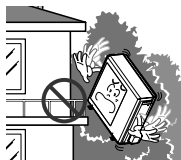

Install the indoor unit on the wall where the height from the floors more then 1.5m(4.9ft)

- There are sharp moving parts that could cause personal injury.

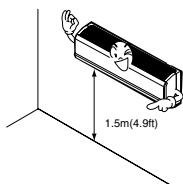

Do not handle the pipe by yourself(customer)

- High-Pressure refrigerant may cause personal injury.

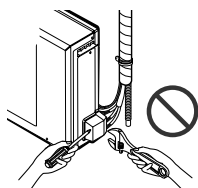

■ Operation

Use a dedicated outlet for this appliance.

- There is risk of fire or electric shock.

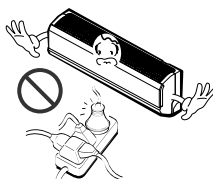

Grasp the plug to remove the cord from the outlet. Do not touch it with wet hands.

- There is risk of fire or electric shock.



Do not allow water to run into electric part.

- There is risk of fire, failure of the product, and/or electric shock.



Do not place a heater or other appliances near the power cable.

- There is risk of fire, failure of the product, and/or electric shock.

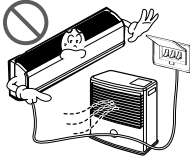

Do not let the air conditioner run for a long time when the humidity is very high and a door or a window is left open.

- Moisture may condense and wet or damage furnishings.



Do not store or use flammable gas or combustibles near the air conditioner.

- There is risk of fire or product failure.



Do not use the product in a tightly closed space for a long time.

- Oxygen deficiency could occur.
- Some ventilation by opening window is necessary for the fresh air.

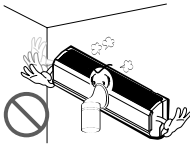

When flammable gas leaks, turn off the gas and open a window for ventilation before turning the product on. Do not use the telephone or turn switches on or off.

- There is risk of explosion or fire.

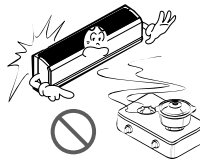

Unplug the unit if strange sounds odors or smoke comes from it.

- There is risk of fire product failure and/or electric shock.



Stop operation and close any window in storm or hurricane. before the hurricane arrives.

- There is risk of property damage, failure of product, or electric shock.

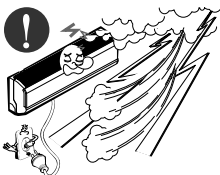

Do not open the inlet grill of the product during operation. (Do not touch the electrostatic filter, if the unit is so equipped.)

- There is risk of physical injury, electric shock, or product.



When the product is soaked (flooded or submerged), contact an Authorized Service Center.

- There is risk of electrical shock.



Ventilate the product from time to time when operating it together with a stove, etc.

- There is risk of fire or electrical shock.

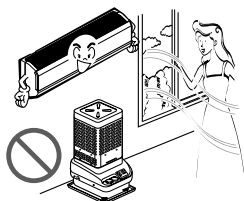

Unplug the appliance before performing cleaning or maintenance.

- There is risk of electric shock.



When the product is not be used for a long time disconnect the power supply plug or turn off the breaker.

- There is risk of product damage or failure, or unintended operation.

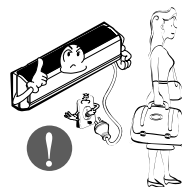

Take care to ensure that nobody could step on or fall onto the outdoor unit.

- There could result in personal injury and product damage.



Do not insert hands or other objects through the air inlet or outlet while the air conditioner is plugged in.

- There are sharp and moving parts that could cause personal injury.

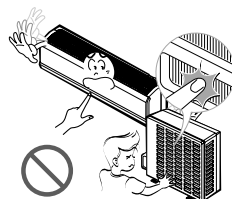

CAUTION

Installation

Always check for gas(refrigerant) leakage after installation or repair of product.

- Low refrigerant levels may cause product failure.

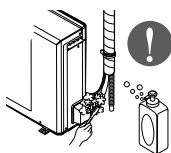

Install the drain hose to ensure that water is drained away properly.

- A bad connection may cause water leakage.

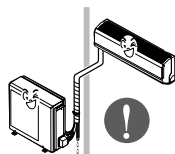

Keep level even when installing the product.

- To avoid vibration or water leakage.

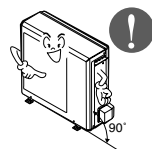

Do not install the product where the noise or hot air from the outdoor unit could damage the neighborhoods.

- It may cause a problem for your neighbors.

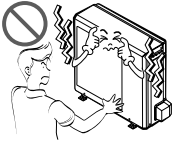

Use two or more people to lift and transport the air conditioner

- Avoid personal injury.



Do not install the product where it will be exposed to sea wind (salt spray) directly.

- It may cause corrosion in the product. Corrosion, particularly on the condenser and evaporator fins, could cause product malfunction or inefficient operation.

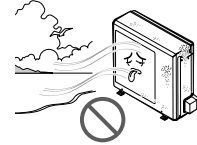

■ Operation

Do not direct airflow at room occupants.

- This could damage your health.



Do not use the product for special purposes, such as preserving foods, works of art, etc. It is a consumer air conditioner, not a precision refrigeration system.

- There is risk of damage or loss of property.

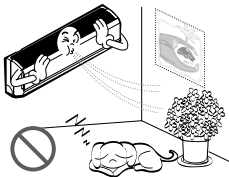

Do not block the inlet or outlet of air flow.

- It may cause product failure.

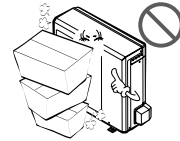

Use a soft cloth to clean. Do not use harsh detergents, solvents, etc.

- There is risk of fire, electric shock or damage to the plastic parts of the product.

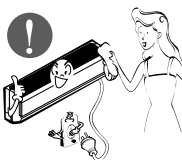

Do not touch the metal parts of the product when removing the air filter. They are very sharp!

- There is risk of personal injury.



Do not step on or put anything on the product. (outdoor unit)

- There is risk of personal injury and failure of product.



Always insert the filter securely. Clean the filter every two weeks or more often if necessary.

- A dirty filter reduces the efficiency of the air conditioner and could cause product malfunction or damage.



Do not drink the water drained from the unit.

- It is not sanitary and could cause serious health issues.



Use a firm stool or ladder when cleaning or maintaining the air conditioner.

- Be careful and avoid personal injury.

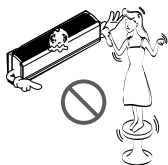

Replace all the batteries in the remote.

- There is risk of fire or explosion.

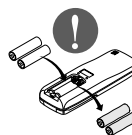

■ Disuse

Do not recharge or disassemble the batteries. Do not dispose of batteries in a fire.

- They may burn or explode.

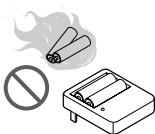

If the liquid from the batteries gets onto your skin or clothes, wash it well with clean water. Do not use the remote if the batteries have leaked.

- The chemicals in batteries could cause burns or other health hazards.



Introduction

Symbols Used In This Manual



This symbol alerts you to the risk of electric shock.



This symbol alerts you to hazards that may cause harm to the air conditioner.

NOTICE

This symbol indicates special notes.



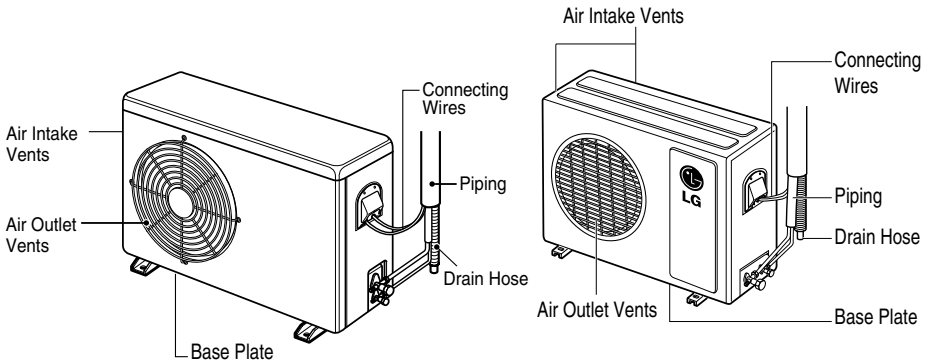
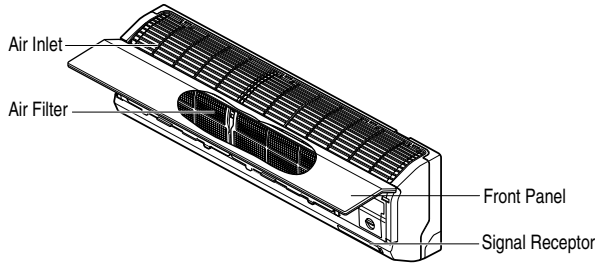

Features





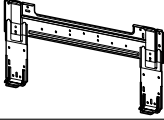



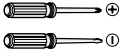

Installation

Read carefully, and then follow step by step.

Installation Parts

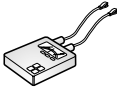
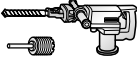
<p>Installation plate</p>	<p>Type "A" screw and plastic anchor</p>
	
<p>Type "B" screw</p>	<p>Remote Control Holder</p>
	

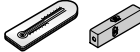
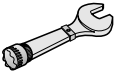
Installation Tools

Figure	Name	Figure	Name
	<p>Screw driver</p>		<p>Ohmmeter</p>
	<p>Electric Drill</p>		<p>Hexagonal wrench</p>
	<p>Measuring Tape, Knife</p>		<p>Ammeter</p>
	<p>Hole Core Drill</p>		<p>Gas Leak Detector</p>
	<p>Spanner</p>		<p>Thermometer, Level</p>
	<p>Torque wrench</p>		<p>Flaring Tool Set</p>

Installation Map

NOTICE

Installation parts you should purchase.

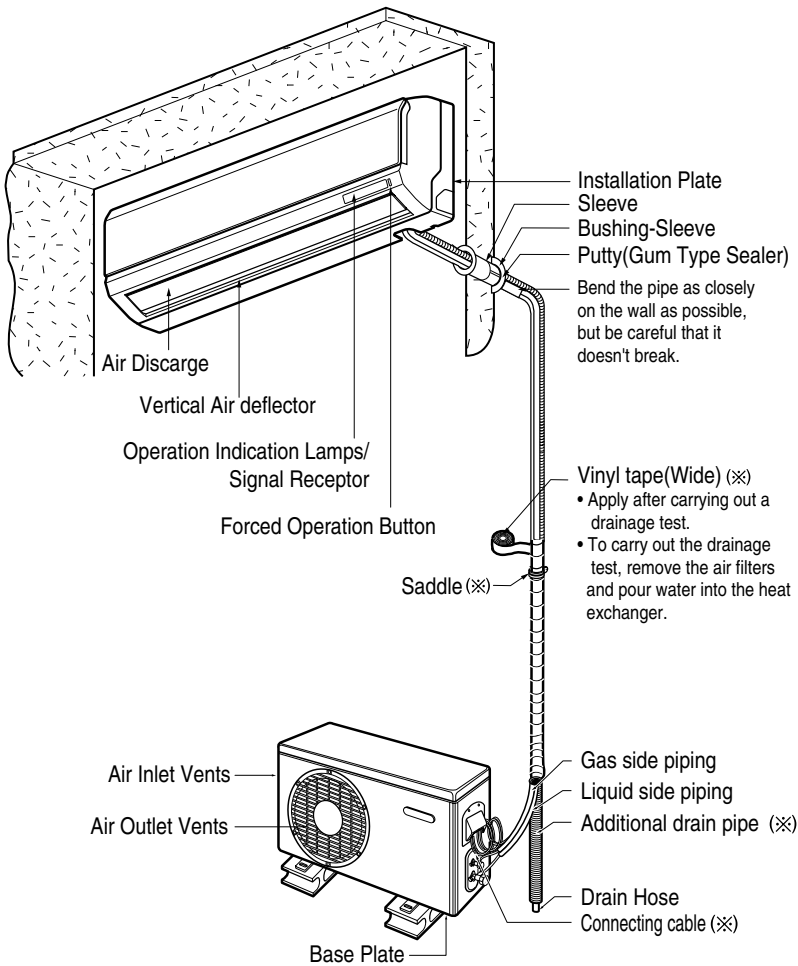

NOTE: refrigerant line wall thickness must be at least 0.8 mm (0.031 inch)

Confirm The Refrigerant

1. Check the quality label on the indoor and outdoor unit.
2. Make certain that the refrigerant is R-410A.

NOTICE

THIS PRODUCT CONTAINS R-410A REFRIGERANT

- 1) Different compressor oil
 - R-410A(Polyol ester) / R-22(Mineral).
 - Do not mix the existing mineral oil.
 - Do not apply used pipe, tools and gauges covered with the existing mineral oil.
- 2) Absorption of moisture
 - Compressor's oil has the high absorption rate of moisture.
- 3) Composition
 - R-410A(R32:R125=50:50wt%).

NOTE: Never mix with other refrigerants

Example : Split type 12,000 Btu/h

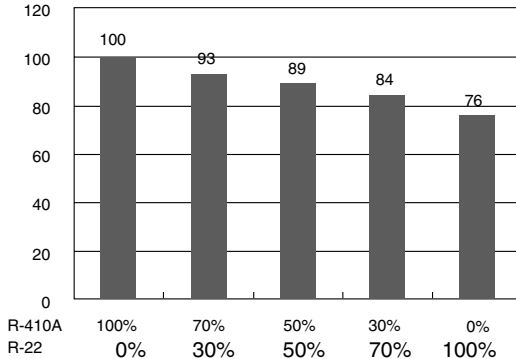

- 4) High pressure.
 - 1.6 times higher than R-22.
 - High Pressure refrigerant may cause personal injury.

	Boiling Pt.(°C)	Vapor pressure(25°C)(kg f/cnf)	Vapor density(25°C)(kg/m ³)
R-410A	-51.4	15.9	64
R-22	-40.8	9.6	44.4

Do not handle the pipe by yourself (customer) High-pressure refrigerant may cause personal injury.
 - manifold gauge ,charging and any piping tools must be dedicated to R-410A systems.

Select The Best Location

Indoor unit

1. Do not have any heat or steam near the unit.
2. Select a place where there are no obstacles in front of the unit.
3. Make sure that condensation drainage can be conveniently routed away.
4. Do not install near a doorway.
5. Ensure that the space around the left and right of the unit is more than 30cm(11.8in).
The unit should be installed as high on the wall as possible, allowing a minimum of 20cm(7.9in) from ceiling.

6. Use a stud finder to locate studs to prevent unnecessary damage to the wall.

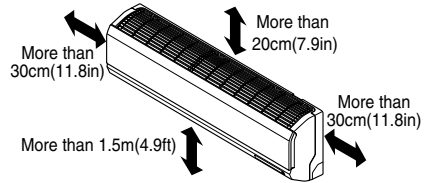

⚠ CAUTION

Install the indoor unit on the wall where the height from the floors more than 1.5meters(4.9ft). A minimum pipe run of 7.5meters(24.6ft) is required to minimize vibration and excessive noise.

Outdoor unit

1. If an awning is built over the unit to prevent direct sunlight or rain exposure, make sure that heat radiation from the condenser is not restricted.
2. Ensure that the space around the back and sides is more than 30cm(11.8in). The front of the unit should have more than 70cm(27.6in) of space.
3. Do not place animals and plants in the path of the warm air.
4. Take the air conditioner weight into account and select a place where noise and vibration are minimum.

5. Select a place so that the warm air and noise from the air conditioner do not disturb neighbors.

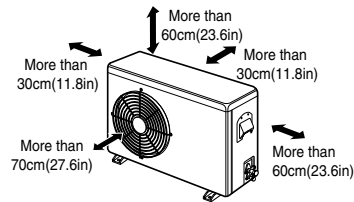

Rooftop Installations

If the outdoor unit is installed on a roof structure, be sure to level the unit. Ensure the roof structure and anchoring method are adequate for the unit location. Consult local codes regarding rooftop mounting.

If the outdoor unit is installed on roof structures or walls, this may result in excessive noise and vibration, and may be also classed as non serviceable installation.

Piping Length And Elevation

Capacity (Btu/h)	Pipe Size		Standard Length m(ft)	Max. Elevation ⓑ m(ft)	Max. length Ⓐ m(ft)	Additional Refrigerant g/m(oz/ft)
	Suction	Evap				
9k(C/O)	Ø9.52(3/8")	Ø6.35(1/4")	7.5(25)	7.5(25)	15(49)	20(0.22)
9K(H/P), 12k	Ø12.7(1/2")	Ø6.35(1/4")	7.5(25)	7.5(25)	15(49)	20(0.22)
18k(C/O)	Ø12.7(1/2")	Ø6.35(1/4")	7.5(25)	15(49)	30(98)	20(0.22)
18k(H/P), 24k	Ø15.88(5/8")	Ø6.35(1/4")	7.5(25)	15(49)	30(98)	20(0.22)

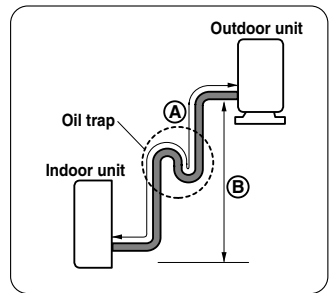
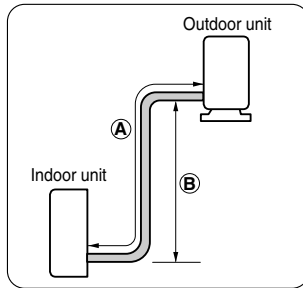
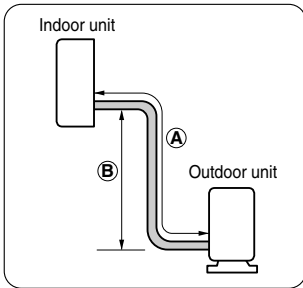

In case more than 5m(16.4ft)

⚠ CAUTION

- Capacity is based on standard length and maximum allowance length is on the basis of reliability.
- Oil trap should be installed every 5~7meters (16.4~23.0ft).

How To Mount Installation Plate

The wall you select should be strong and solid enough to prevent vibration

1. Mount the installation plate on the wall with type "A" screws. If mounting the unit on a concrete wall, use anchor bolts.
 - Mount the installation plate horizontally by aligning the centerline using a level.

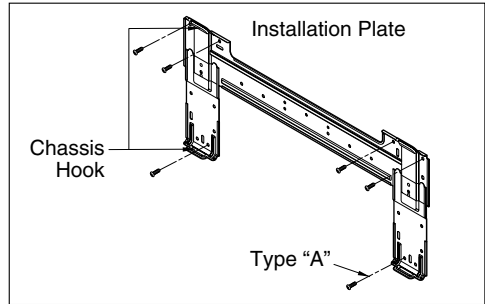

2. Measure the wall and mark the centerline. It is also important to use caution concerning the location of the installation plate—routing of the wiring to power outlets is through the walls typically. Drilling the hole through the wall for piping connections must be done safely.

CHASSIS (Grade)	Distance (mm)			
	A	B	C	D
S4	50	105	59	105
SE	65	110	85	110
S5	95	122	235	122

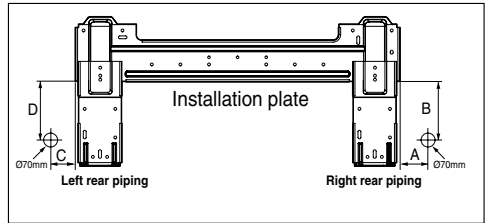

Drill a Hole In The Wall

- Drill the piping hole with a $\varnothing 70\text{mm}$ (2.76in) hole core drill. Drill the piping hole at either the right or the left with the hole slightly slanted to the outdoor side.

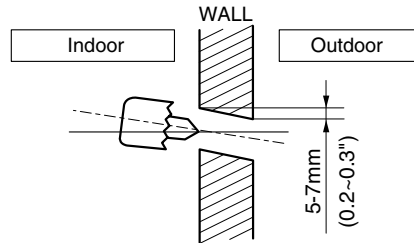

Flaring Work

Main cause for gas leakage is due to defect in flaring work. Carry out correct flaring work in the following procedure.

Cut the pipes and the cable.

1. Use the piping kit accessory or the pipes purchased locally.
2. Measure the distance between the indoor and the outdoor unit.
3. Cut the pipes a little longer than measured distance.
4. Cut the cable 1.5m(59.1in) longer than the pipe length.

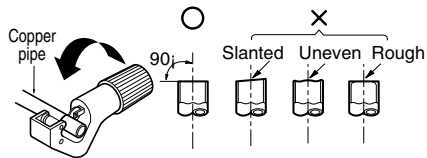

Burrs removal

1. Completely remove all burrs from the cut cross section of pipe/tube.
2. Put the end of the copper tube/pipe in a downward direction as you remove burrs in order to avoid dropping burrs into the tubing.

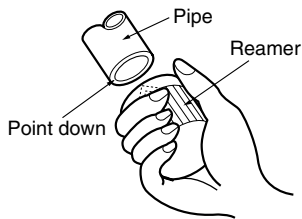

Putting nut on

- Remove flare nuts attached to indoor and outdoor unit, then put them on pipe/tube having completed burr removal. (not possible to put them on after flaring work)

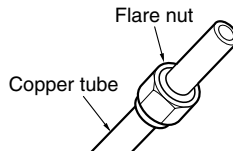

Flaring work

- Carry out flaring work using flaring tool as shown below.

Outside diameter		A
mm	inch	mm
Ø6.35	1/4	1.1~1.3
Ø9.52	3/8	1.5~1.7
Ø12.7	1/2	1.6~1.8
Ø15.88	5/8	1.6~1.8

Firmly hold copper pipe in a die in the dimension shown in the table above.

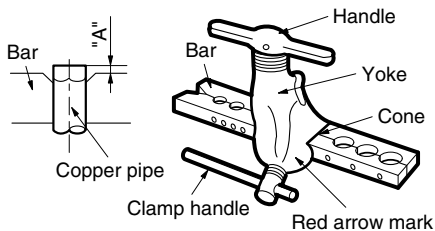

Connecting The Piping

Indoor

1. Prepare the indoor unit's piping and drain hose for installation through the wall.
2. Remove the plastic tubing retainer(see the illustration by) and pull the tubing and drain hose away from chassis.
3. Replace only the plastic tubing holder 1, not the holder 2 in the original position.

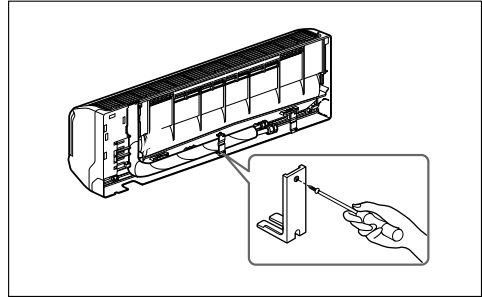

For left rear piping

Route the indoor tubing and the drain hose in the direction of rear left.

Insert the connecting cable into the indoor unit from the outdoor unit through the piping hole.

- Do not connect the cable to the indoor unit.
- Make a small loop with the cable for easy connection later.

Tape the tubing, drain hose and the connecting cable. Be sure that the drain hose is located at the lowest side of the bundle. Locating at the upper side can cause drain pan to overflow inside the unit.

NOTE: If the drain hose is routed inside the room, insulate the hose with an insulation material* so that dripping from "sweating"(condensation) will not damage furniture or floors.

*Foamed polyethylene or equivalent is recommended.

Indoor unit installation

- Hook the indoor unit onto the upper portion of the installation plate.(Engage the three hooks of the rear top and rear lower of the indoor unit with the upper edge and lower edge of the installation plate.) Ensure that the hooks are properly seated on the installation plate by moving it left and right.

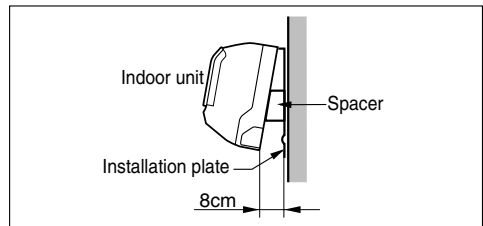
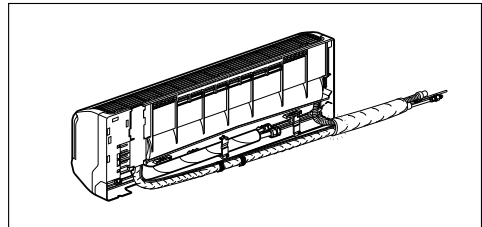
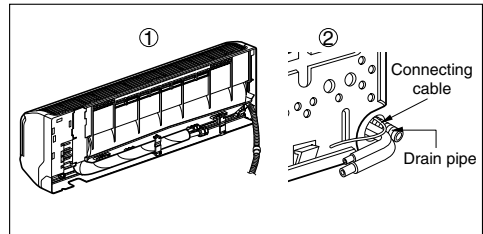

Connecting the pipings to the indoor unit and drain hose to drain pipe.

- Put a couple drops of refrigerant oil on the face of the flare before assembling taking care not to add any contaminants.
- Align the center of the pipings and sufficiently tighten the flare nut by hand.

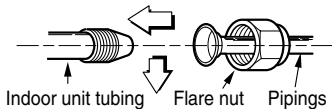

- Tighten the flare nut with a wrench.

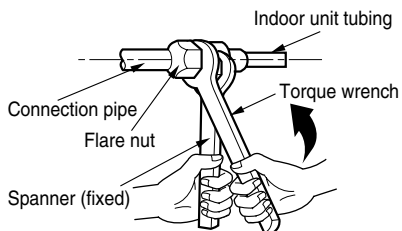

Outside diameter		Torque kgf·m
mm	inch	
Ø6.35	1/4	1.8~2.5
Ø9.52	3/8	3.4~4.2
Ø12.7	1/2	5.5~6.6
Ø15.88	5/8	6.3~8.2

- Mount the clamp on the boss with a type "B" screw. (SE-H/P: 9k, 12k C/O: 12k)

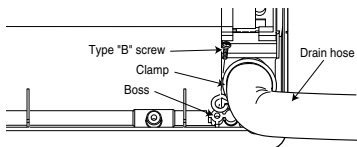

- When extending the drain hose at the indoor unit, install the drain pipe.

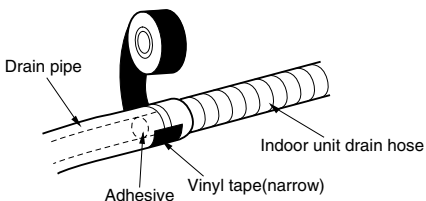

Wrap the insulation material around the connecting portion.

- Overlap the connection pipe insulation material and the indoor unit pipe insulation material. Bind them together with vinyl tape so that there is no gap.

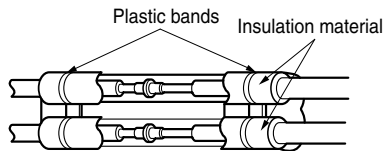

- Wrap the area which accommodates the rear piping housing section with vinyl tape.

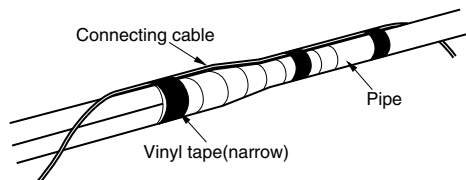
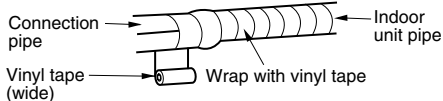

- Bundle the piping and drain hose together by wrapping them with vinyl tape over the range within which they fit into the rear piping housing section.

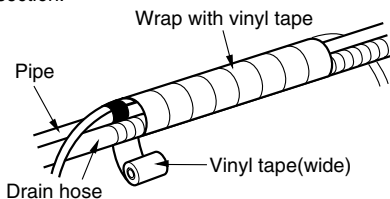

For right rear piping

Route the indoor tubing and the drain hose to the required piping hole position.

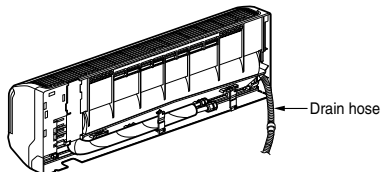

Insert the connecting cable into the indoor unit.

- Don't connect the cable to the indoor unit.
- Make a small loop with the cable for easy connection later.

Tape the drain hose and the connecting cable.

- Connecting cable

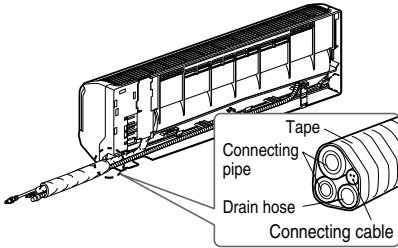

Indoor unit installation

- Hook the indoor unit onto the upper portion of the installation plate. (Engage the three hooks of the rear top and rear lower of the indoor unit with the upper edge and lower edge of the installation plate.) Ensure that the hooks are properly seated on the installation plate by moving it left and right.

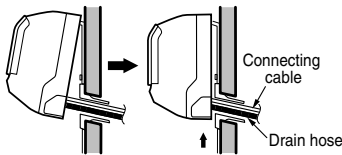

Connecting the pipings to the indoor unit and the drain hose to drain pipe.

- Put a couple drops of refrigerant oil on the face of the flare before assembling taking care not to add any contaminants
- Align the center of the pipings and sufficiently tighten the flare nut by hand.

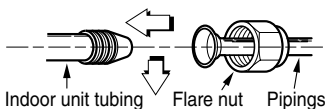

- Tighten the flare nut with a wrench.

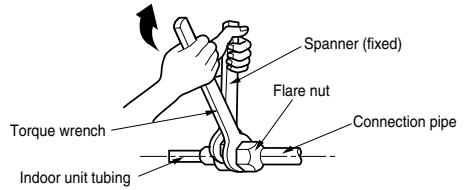

Outside diameter		Torque
mm	inch	kgf·m
Ø6.35	1/4	1.8~2.5
Ø9.52	3/8	3.4~4.2
Ø12.7	1/2	5.5~6.6
Ø15.88	5/8	6.3~8.2

- Mount the clamp on the boss with a type "B" screw. (SE-H/P: 9k, 12k C/O: 12k)

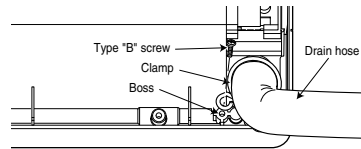

- When extending the drain hose at the indoor unit, install the drain pipe.

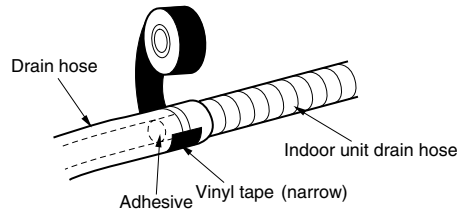

Wrap the insulation material around the connecting portion.

- Overlap the connection pipe heat insulation and the indoor unit pipe heat insulation material. Bind them together with vinyl tape so that there is no gap.

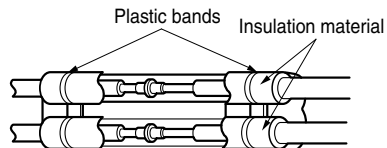

- Wrap the area which accommodates the rear piping housing section with vinyl tape.

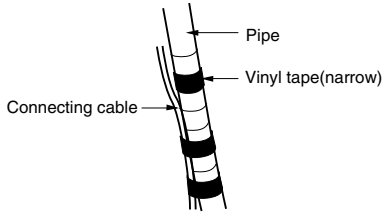
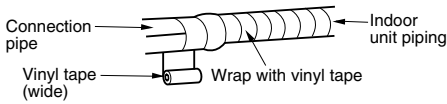

- Bundle the piping and drain hose together by wrapping them with cloth tape over the range within which they fit into the rear piping housing section.

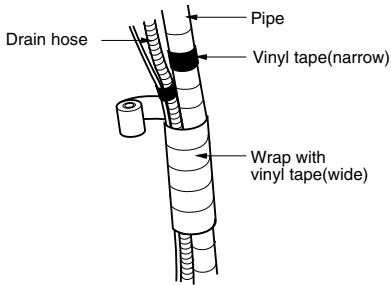

Reroute the pipings and the drain hose across the back of the chassis.

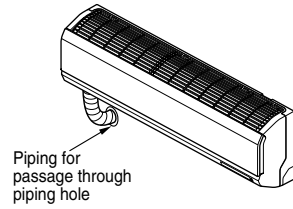

Reroute the pipings and the drain hose across the back of the chassis.

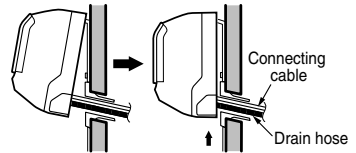

▲ CAUTION

Installation Information. For left piping. Follow the instruction below.

Correct case

- Press on the upper side of clamp and unfold the tubing to downward slowly.

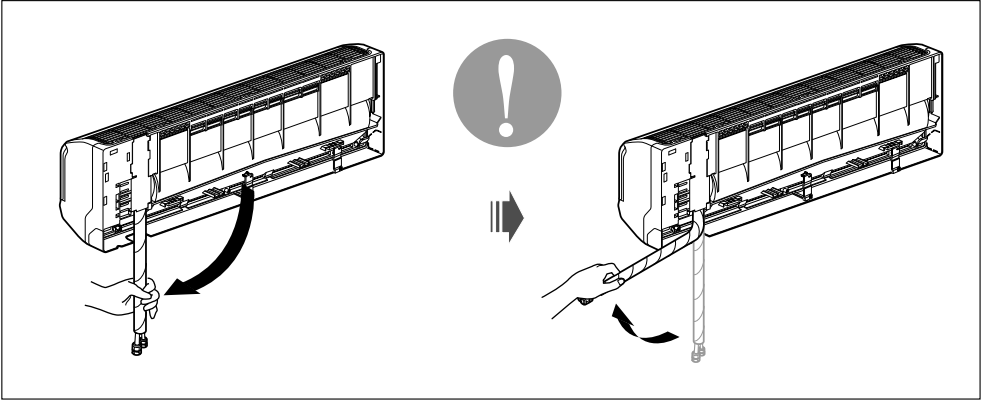
**Incorrect case**

- Following bending type from right to left may cause damage to the tubing.

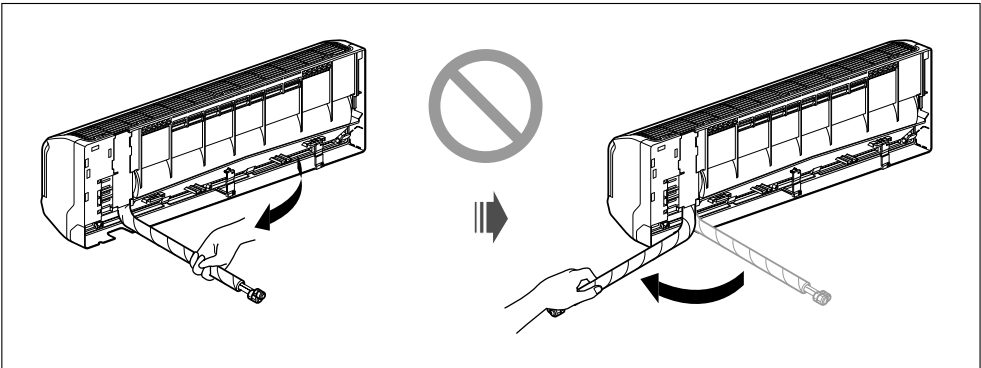

Connection Of The Drain Hose

- The drain hose can be connected at two different positions. Use the most convenient position and, if necessary, exchange the position of the drain pan, rubber cap and the drain hose.

- ❶ Drain pan
- ❷ Rubber cap
- ❸ Drain hose
- ❹ Exchange if necessary

- Remove the drain hose.
- Securely insert both the rubber plug and drain hose into the drain outlets.
Be sure the rubber the cap is securely fastened so that there is no leakage.

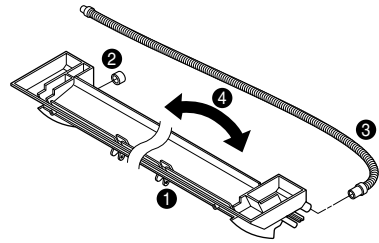

Connection Of Piping -Outdoor

Put a couple drops of refrigerant oil on the face of the flare before assembling taking care not to add any contaminants.

Align the center of the pipings and sufficiently tighten the flare nut by hand.

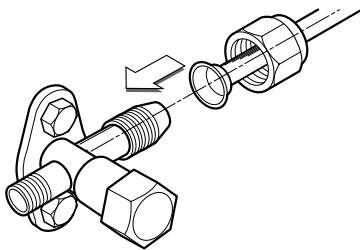

Finally, tighten the flare nut with torque wrench until the wrench clicks.

- When tightening the flare nut with torque wrench, ensure the direction for tightening follows the arrow on the wrench.

Outside diameter		Torque kgf·m
mm	inch	
Ø6.35	1/4	1.8~2.5
Ø9.52	3/8	3.4~4.2
Ø12.7	1/2	5.5~6.6
Ø15.88	5/8	6.3~8.2

Outdoor unit

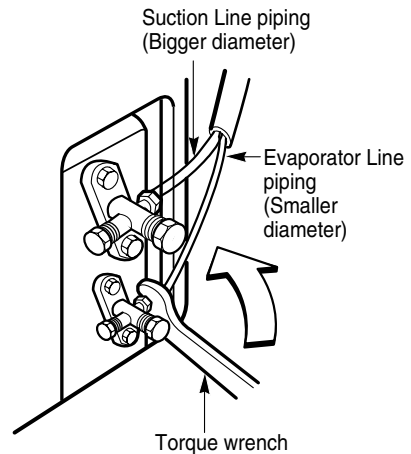

Connection Of The Cable

1. Remove the cover control from the unit by loosening the 3 screws.
2. Dismount caps on the conduit panel.
3. Temporarily mount the conduit tubes on the conduit panel.
4. Properly connect both the power supply and low voltage lines to the corresponding terminals on the terminal block.
5. Ground the unit in accordance with local codes.
6. Be sure to size each wire allowing several inches longer than the required length for wiring.
7. Use lock nuts to secure the conduit tubes.

NOTE

Connector trade size for this unit is 1/2" for instructions on connecting depending on the wire type you are using.

⚠ WARNING

- Be sure to comply with local codes while running the wire from the indoor unit to the outdoor unit (size of wire and wiring method, etc).
- Every wire must be connected firmly.
- No wire should be allowed to touch refrigerant tubing, the compressor or any moving parts.

Power Supply

Model	Power source	AWG(MIN.)		Fuse or breaker Capacity
		(a)	(b)	
9k(C/O)	1Ø,115V	14	18	15A
9K(H/P),12k	1Ø,115V	14	18	20A
18k(C/O)	1Ø,230/208V	14	18	20A
18k(H/P),24k	1Ø,230/208V	12	18	30A

Wiring Diagram

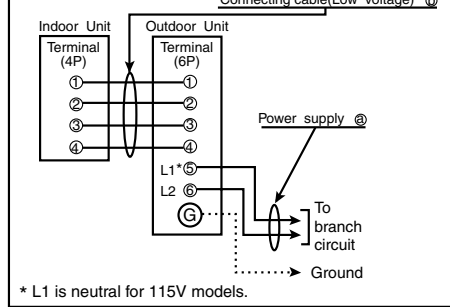

NOTE

1. shows field wiring.
2. Separately wire the high and low voltage line.
3. Use heat-proof electrical wiring capable of withstanding temperatures up to 167°F.
4. Use outdoor and waterproof connection cable rated more than 300V for the connection between indoor and outdoor unit. (For example, Type STOW)

Outdoor unit

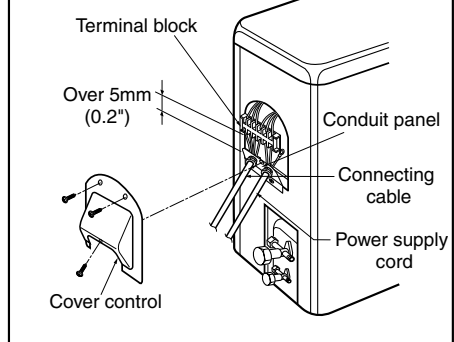

CAUTION

After the confirmation of the above conditions, prepare the wiring as follows:

- 1) **Never fail to have an individual power circuit specifically for the air conditioner. As for the method of wiring, be guided by the circuit diagram posted on the inside of control cover.**
- 2) **The screw which fasten the wiring in the casing of electrical fittings are liable to come loose from vibrations to which the unit is subjected during the course of transportation. Check them and make sure that they are all tightly fastened. (If they are loose, it could cause burn-out of the wires.)**
- 3) **Specification of power source.**
- 4) **Confirm that electrical capacity is sufficient.**
- 5) **Confirm that the starting voltage is maintained at more than 90 percent of the rated voltage marked on the name plate.**
- 6) **Confirm that the cable thickness is as specified in the power source specification. (Particularly note the relation between cable length and thickness.**
- 7) **Always install an GFCI circuit breaker in a wet or moist area.**
- 8) **The following would be caused by voltage drop.**
 - **Vibration of a magnetic switch, which will damage the contact point, open fuse, disturbance of the normal function of the overload.**
- 9) **The means for disconnection from a power supply shall be incorporated in the fixed wiring and have an air gap contact separation of at least 3mm(0.12in) in each active(phase) conductors.**

Checking The Drainage

- Pour a glass of water on the drain pan.
- Ensure the water flows through the drain hose of the indoor unit without any leakage and goes out the drain exit.

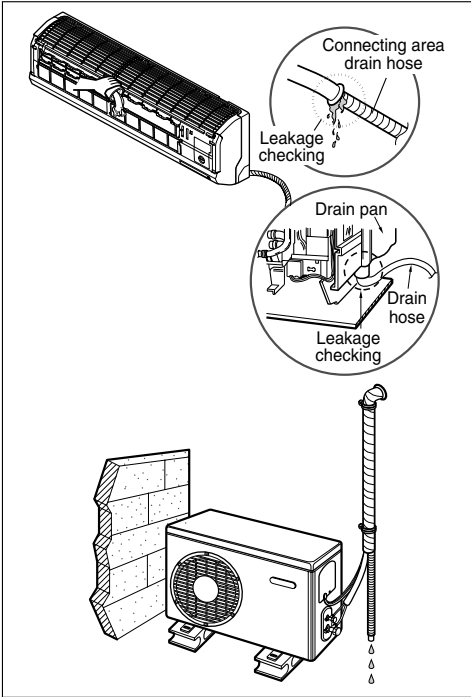

Drain piping

- The drain hose should point downward for easy drain flow.

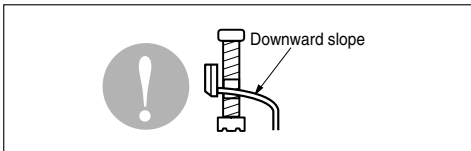

- Avoid these situations.

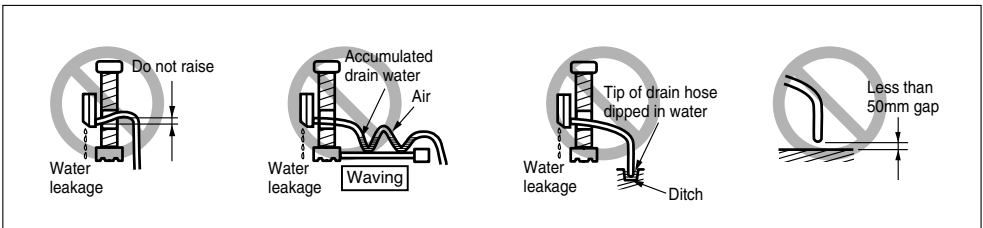

Forming The Piping

Form the piping by wrapping the connecting portion of the indoor unit with insulation material and secure it with two kinds of vinyl tapes.

- If you want to connect an additional drain hose, the end of the drain outlet should be routed above the ground. Secure the drain hose appropriately.

In cases where the outdoor unit is installed below the indoor unit perform the following.

- Tape the piping, drain hose and connecting cable from down to up.
- Secure the tapped piping along the exterior wall using saddle or equivalent.

In cases where the Outdoor unit is installed above the Indoor unit perform the following.

- Tape the piping and connecting cable from down to up.
- Secure the taped piping along the exterior wall. Form a trap to prevent water entering the room.
- Fix the piping onto the wall by saddle or equivalent.

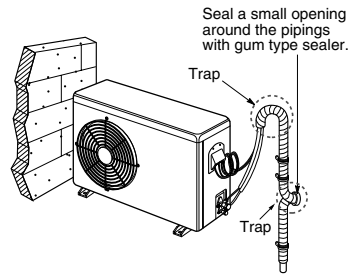
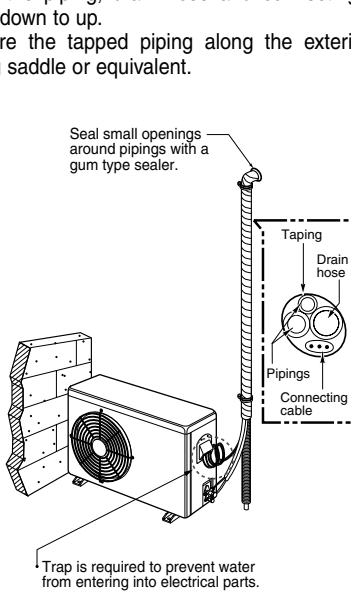

Air Purging

Air and moisture remaining in the refrigerant system have undesirable effects as indicated below.

- Pressure in the system rises.
- Operating current rises.
- Cooling(or heating) efficiency drops.
- Moisture in the refrigerant circuit may freeze and block capillary tubing.
- Water may lead to corrosion of parts in the refrigeration system.

Therefore, the indoor unit and tubing between the indoor and outdoor unit must be leak tested and evacuated to remove any noncondensables and moisture from the system.

Air purging With Vacuum Pump

Preparation

- Check that each tubing(both liquid and gas side tubes) between the indoor and outdoor units have been properly connected and all wiring for the test run has been completed. Remove the service valve caps from both the gas and the liquid side on the outdoor unit. Note that both the liquid and the gas side service valves on the outdoor unit are kept closed at this stage.

Leak test

- Connect the manifold valve(with pressure gauges) and dry nitrogen gas cylinder to this service port with charge hoses.

CAUTION

Be sure to use a manifold valve for air purging. If it is not available, use a stop valve for this purpose. The "Hi" knob of the manifold valve must always be kept close.

- Pressurize the system to no more than 150 P.S.I.G. with dry nitrogen gas and close the cylinder valve when the gauge reading reached 150 P.S.I.G. Next, test for leaks with liquid soap.

CAUTION

To avoid nitrogen entering the refrigerant system in a liquid state, the top of the cylinder must be higher than its bottom when you pressurize the system. Usually, the cylinder is used in a vertical standing position.

- Do a leak test of all joints of the tubing(both indoor and outdoor) and both gas and liquid side service valves. Bubbles indicate a leak. Be sure to wipe off the soap with a clean cloth.
- After the system is found to be free of leaks, relieve the nitrogen pressure by loosening the charge hose connector at the nitrogen cylinder. When the system pressure is reduced to normal, disconnect the hose from the cylinder.

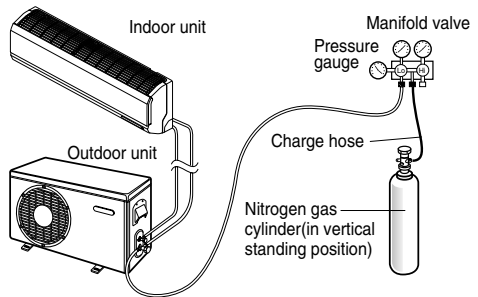

Soap water method

- (1) Remove the caps from the gas side and liquid side valves.
- (2) Remove the service-port cap from the gas side valve.
- (3) To open the gas side valve turn the valve stem counterclockwise approximately 90°, wait for about 2~3 seconds, and close it.
- (4) Apply a soap water or a liquid neutral detergent on the indoor unit connection or outdoor unit connections by a soft brush to check for leakage of the connecting points of the piping.
- (5) If bubbles come out, the pipes have leakage.

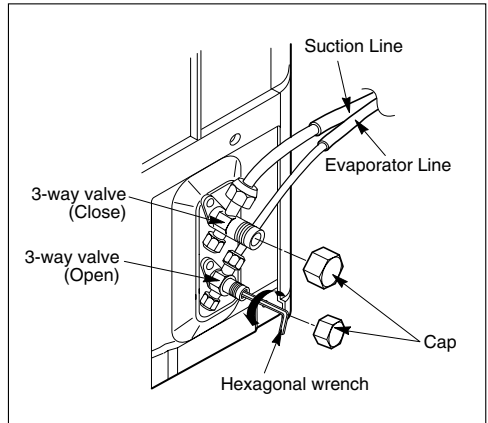

Evacuation

- Connect the charge hose end described in the preceding steps to the vacuum pump to evacuate the tubing and indoor unit. Confirm the "Lo" knob of the manifold valve is open. Then, run the vacuum pump. The operation time for evacuation varies with tubing length and capacity of the pump. The following table shows the time required for evacuation.

Required time for evacuation when 30 gal/h vacuum pump is used	
If tubing length is less than 10m (33 ft)	if tubing length is longer than 10m (33 ft)
10 min. or more	15 min. or more

- When the desired vacuum is reached, close the "Lo" knob of the manifold valve and stop the vacuum pump.

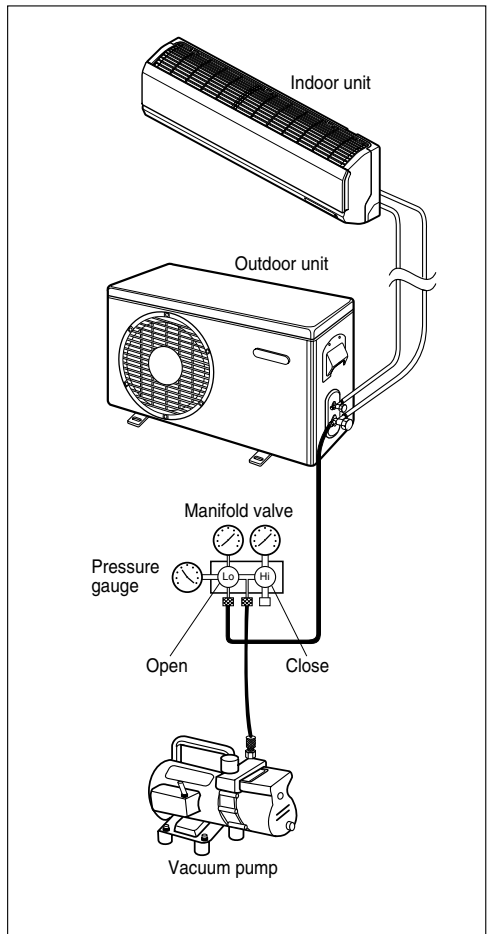

Finishing the job

- With a service valve wrench, turn the valve stem of liquid side valve counter-clockwise to fully open the valve.
 - Turn the valve stem of gas side valve counter-clockwise to fully open the valve.
 - Loosen the charge hose connected to the gas side service port slightly to release the pressure, then remove the hose.
 - Replace the flare nut and its bonnet on the gas side service port and fasten the flare nut securely with an adjustable wrench. This process is very important to prevent leakage from the system.
 - Replace the valve caps at both gas and liquid side service valves and fasten them tight.
- This completes air purging with a vacuum pump. The air conditioner is now ready to test run.

Charging

- Each outdoor unit is factory charged (nameplate charge) for the evaporator as well as a 7.5m(25ft) line set. Any time a line set is used either shorter or longer than the nominal 7.5m(25ft) line set length the refrigerant charge has to be adjusted.
- Whether the line set is made shorter or longer you must adjust the charge based on how many ft of tubing are either added or removed based on 20g(0.22oz) of R-410A per meter(foot).

Capacity (Btu/h)	Pipe Size		Standard Length m(ft)	Max. Elevation Ⓢ m(ft)	Max. length Ⓐ m(ft)	Additional Refrigerant g/m(oz/ft)
	Suction	Evap				
9k(C/O)	Ø9.52(3/8")	Ø6.35(1/4")	7.5(25)	7.5(25)	15(49)	20(0.22)
9K(H/P),12k	Ø12.7(1/2")	Ø6.35(1/4")	7.5(25)	7.5(25)	15(49)	20(0.22)
18k(C/O)	Ø12.7(1/2")	Ø6.35(1/4")	7.5(25)	15(49)	30(98)	20(0.22)
18k(H/P),24k	Ø15.88(5/8")	Ø6.35(1/4")	7.5(25)	15(49)	30(98)	20(0.22)

Example: A 30ft line set is used

5 additional ft X 0.22 ounce per foot= add 1.1 ounces of R-410A

Important:

If you are ever uncertain of the unit charge, reclaim, evacuate and weigh in the correct charge using the unit nameplate charge adjusting for line sets longer or shorter than 7.5m(25ft).

⚠ CAUTION

Confirm the refrigerant R-410A. Use manifold gauge and hose for R-410A.

Test Running

1. Check that all tubing and wiring have been properly connected.
2. Check that the gas and liquid side service valves are fully open.

Prepare remote control

1. Remove the battery cover by pulling it according to the arrow direction.
2. Insert new batteries making sure that the (+) and (-) of battery are installed correctly.
3. Reattach the cover by pushing it back into position.

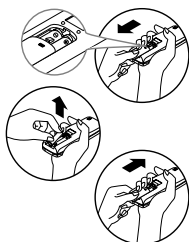

NOTE:

- Use 2 AAA(1.5volt) batteries. Do not use rechargeable batteries.
- Remove the batteries from the remote control if the system is not going to be used for a long time.

Settlement of outdoor unit

- Anchor the outdoor unit with a bolt and nut($\phi 10\text{mm}(0.39\text{in})$) tightly and horizontally on a concrete or rigid mount.
- When installing on the wall, roof or rooftop, anchor the mounting base securely with a nail or wire assuming the influence of wind and earthquake.
- In the case when the vibration of the unit is conveyed to the hose, secure the unit with an anti-vibration rubber.

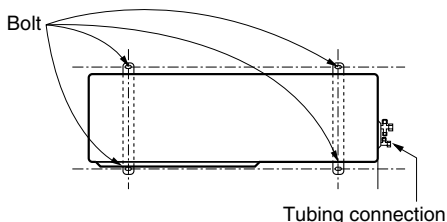

Evaluation of the performance

Operate unit for 15~20 minutes, then check the system refrigerant charge:

1. Measure the pressure of the gas side service valve.
2. Measure the temperature of the intake and discharge of air.

3. Ensure the difference between the intake temperature and the discharge is more than $46.4^{\circ}\text{F}(8^{\circ}\text{C})$ (Cooling) or (Heating).

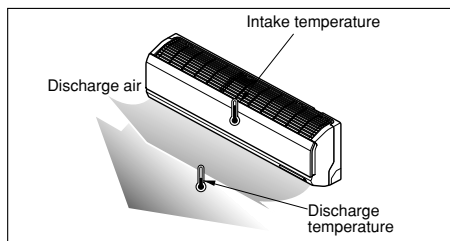

4. For reference; the gas side pressure of optimum condition is as below.(Cooling)

Outside ambient TEMP.	The pressure of the gas side service valve
$95^{\circ}\text{F}(35^{\circ}\text{C})$	$8.5\text{--}9.5\text{kg}/\text{cm}^2\text{G}(120\text{--}135\text{ P.S.I.G.})$

NOTE: If the actual pressure are higher than shown, the system is most likely over-charged, and charge should be removed. If the actual pressure are lower than shown, the system is most likely undercharged, and charge should be added.

The air conditioner is now ready for use.

PUMP DOWN

This is performed when the unit is to be relocated or the refrigerant circuit is serviced.

Pump Down means collecting all refrigerant in the outdoor unit without loss of refrigerant.

CAUTION:

Be sure to perform Pump Down procedure with the unit cooling mode.

Pump Down Procedure

1. Connect a low-pressure gauge manifold hose to the charge port on the gas side service valve.
2. Open the gas side service valve halfway and purge the air from the manifold hose using the refrigerant gas.
3. Close the liquid side service valve(all the way in).
4. Turn on the unit's operating switch and start the cooling operation.
5. When the low-pressure gauge reading becomes 1 to $0.5\text{kg}/\text{cm}^2\text{G}(14.2$ to $7.1\text{ P.S.I.G.})$, fully close the gas side valve stem and then quickly turn off the unit. At that time, Pump Down has been completed and all refrigerant will have been collected in the outdoor unit.

Installation guide at the seaside

⚠ CAUTION

1. Air conditioners should not be installed in areas where corrosive gases, such as acid or alkaline gas, are produced.
2. Do not install the product where it could be exposed to sea wind (salty wind) directly. It can result corrosion on the product. Corrosion, particularly on the condenser and evaporator fins, could cause product malfunction or inefficient performance.
3. If outdoor unit is installed close to the seaside, it should avoid direct exposure to the sea wind. Otherwise it needs additional anticorrosion treatment on the heat exchanger.

Selecting the location(Outdoor Unit)

- 1) If the outdoor unit is to be installed close to the seaside, direct exposure to the sea wind should be avoided. Install the outdoor unit on the opposite side of the sea wind direction.

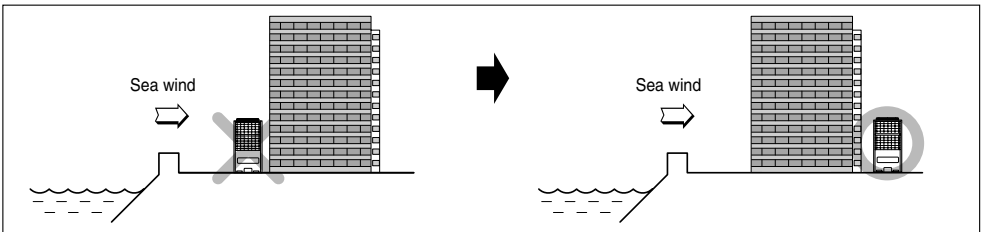

- 2) In case, to install the outdoor unit on the seaside, set up a windbreak not to be exposed to the sea wind.

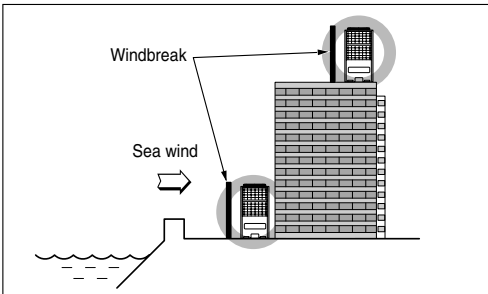

- It should be strong enough like concrete to prevent the sea wind from the sea.
- The height and width should be more than 150% of the outdoor unit.
- It should be keep more than 70 cm of space between outdoor unit and the windbreak for easy air flow.

- 3) Select a well-drained place.

1. If you can't meet above guide line in the seaside installation, please contact LG Electronics for the additional anticorrosion treatment.
2. Periodic (more than once/year) cleaning of the dust or salt particles stuck on the heat exchanger by using water

