

This Owner's Manual is provided and hosted by [Appliance Factory Parts](#).



LG LSN181HSV Owner's Manual

[Shop genuine replacement parts for LG LSN181HSV](#)



[Find Your LG Air Conditioner Parts - Select From 2330 Models](#)

----- Manual continues below part list -----

Available Replacement Parts for LG LSN181HSV

4280A20004M	Bearing
6871A20259D	Sub Pcb Assembly
EAU62004011	Motor Assembly,dc,indoor
ADQ68719501	Air Cleaner Filter Assembly
EAU57945603	Motor Assembly,dc,stepping
EBG60787304	Thermistor Assembly
MCR60969401	Decor
MDJ56986401	Air Filter
MFH59924301	Horizontal Louver
EAU62004010	Motor Assembly,dc,indoor
4681A20042G	Motor Assembly,dc,stepping
ADP67813503	Cross Flow Fan Assembly

INSTALLATION MANUAL

AIR CONDITIONER

- Please read this installation manual completely before installing the product.
- Installation work must be performed in accordance with the national wiring standards by authorized personnel only.
- Please retain this installation manual for future reference after reading it thoroughly.

TYPE : WALL MOUNTED

CONTENTS

<i>Installation Requirements</i>	<i>Required Parts</i>	<i>Required Tools</i>
Safety Precautions4	<input type="checkbox"/> Some pieces of type "A" screws	<input type="checkbox"/> Level gauge
	<input type="checkbox"/> Connecting cable	<input type="checkbox"/> Screw driver
Introduction7	<input type="checkbox"/> Installation guide map	<input type="checkbox"/> Electric drill
Symbols used in this Manual.....7	<input type="checkbox"/> Pipes: Gas side Liquid side	<input type="checkbox"/> Hole core drill(ø70mm)
Installation8	<input type="checkbox"/> Insulation materials	<input type="checkbox"/> Horizontal meter
Installation Parts8	<input type="checkbox"/> Additional drain pipe (Outer diameter15.5mm)	<input type="checkbox"/> Flaring tool set
Installation Tools8	<input type="checkbox"/> Some pieces of type "B" screws	<input type="checkbox"/> Specified torque wrenches 1.8kg.m, 4.2kg.m, 5.5kg.m, 6.6kg.m (different depending on model No.)
Installation Map.....9	<input type="checkbox"/> Some pieces of type "C" screws	<input type="checkbox"/> Spanner.....Half union
Select the best Location10		<input type="checkbox"/> A glass of water
Fixing Installation Plate.....11		<input type="checkbox"/> Hexagonal wrench(4mm)
Drill a Hole in the Wall11		<input type="checkbox"/> Gas-leak detector
Flaring Work.....12		<input type="checkbox"/> Vacuum pump
Connecting the Piping.....13		<input type="checkbox"/> Gauge manifold
Connecting the Cables.....19		<input type="checkbox"/> Owner's manual
Checking the Drainage22		<input type="checkbox"/> Thermometer
Forming the Piping23		<input type="checkbox"/> Remote controller holder
Air Purging24		
Test Running.....26		
Installation guide at the seaside ...28		
Piping Length and Elevation.....29		

Wall Mounted Mini-Split System Single Zone INSTALLATION INSTRUCTIONS

IMPORTANT!

Please read this instruction sheet completely before installing the product.

This air conditioning system meets strict safety and operating standards. As the installer or service person, it is an important part of your job to install or service the system so it operates safely and efficiently.



WARNING

- Refer to local code for all wiring size.
- Installation or repairs made by unqualified persons can result in hazards to you and others. Installation **MUST** conform with local building codes or, in the absence of local codes, with the National Electrical Code NFPA 70/ANSI C1-1993 or current edition and Canadian Electrical Code Part 1 CSA C.22.1.
- The information contained in the manual is intended for use by a qualified service technician familiar with safety procedures and equipped with the proper tools and test instruments.
- Failure to carefully read and follow all instructions in this manual can result in equipment malfunction, property damage, personal injury and/or death.

CAUTION: Improper installation, adjustment, alteration, service or maintenance can void the warranty.

The weight of the condensing unit requires caution and proper handling procedures when lifting or moving to avoid personal injury. Use care to avoid contact with sharp or pointed edges.

Safety Precautions

- Always wear safety eye wear and work gloves when installing equipment.
- Never assume electrical power is disconnected. Check with meter and equipment.
- Keep hands out of fan areas when power is connected to equipment.
- R-410A causes frostbite burns.
- R-410A is toxic when burned.

NOTE TO INSTALLING DEALER: The Owners Instructions and Warranty are to be given to the owner or prominently displayed near the indoor Furnace/Air Handler Unit.



WARNING

When wiring:

Electrical shock can cause severe personal injury or death. Only a qualified, experienced electrician should attempt to wire this system.

- Do not supply power to the unit until all wiring and tubing are completed or reconnected and checked.
- Highly dangerous electrical voltages are used in this system. Carefully refer to the wiring diagram and these instructions when wiring. Improper connections and inadequate grounding can cause accidental injury or death.
- Ground the unit following local electrical codes.
- Connect all wiring tightly. Loose wiring may cause overheating at connection points and a possible fire hazard.

When transporting:

Be careful when picking up and moving the indoor and outdoor units. Get a partner to help, and bend your knees when lifting to reduce strain on your back. Sharp edges or thin aluminum fins on the air conditioner can cut your finger.

When installing...

... **in a wall:** Make sure the wall is strong enough to hold the unit's weight.

It may be necessary to construct a strong wood or metal frame to provide added support.

... **in a room:** Properly insulate any tubing run inside a room to prevent "sweating" that can cause dripping and water damage to wall and floors.

... **in moist or uneven locations:** Use a raised concrete pad or concrete blocks provide a solid, level foundation for the outdoor unit. This prevents water damage and abnormal vibration.

... **in an area with high winds:** Securely anchor the outdoor unit down with bolts and a metal frame. Provide a suitable air baffle.

... **in a snowy area(for Heat Pump Model):** Install the outdoor unit on a raised platform that is higher than drifting snow. Provide snow vents.

When connecting refrigerant tubing

- Keep all tubing runs as short as possible.
- Use the flare method for connecting tubing.
- Check carefully for leaks before starting the test run.

When servicing

- Turn the power OFF at the main power box(mains) before opening the unit to check or repair electrical parts and wiring.
- Keep your fingers and clothing away from any moving parts.
- Clean up the site after you finish, remembering to check that no metal scraps or bits of wiring have been left inside the unit being serviced.

Safety Precautions



To prevent the injury of the user or other people and property damage, the following instructions must be followed.

- Be sure to read before installing the air conditioner.
- Be sure to observe the cautions specified here as they include important items related to safety.
- Incorrect operation due to ignoring instruction will cause harm or damage. The seriousness is classified by the following indications.

 **WARNING** This symbol indicates the possibility of death or serious injury.

 **CAUTION** This symbol indicates the possibility of injury or damage to properties only.

- The meanings of the symbols used in this manual are as shown below.

	Be sure not to do.
	Be sure to follow the instruction.

WARNING

■ Installation

Always perform grounding.

- Otherwise, it may cause electrical shock.

Don't use a power cord, a plug or a loose socket which is damaged.

- Otherwise, it may cause a fire or electrical shock.

For installation of the product, always contact the service center or a professional installation agency.

- Otherwise, it may cause a fire, electrical shock, explosion or injury.

Securely attach the electrical cover to indoor and pipe cover to outdoor unit.

- If the electrical part cover to indoor unit and pipe cover to outdoor unit are not attached securely, it could result in a fire or electric shock due to dust, water, etc.

Always install an air leakage breaker and a dedicated switching board.

- No installation may cause a fire and electrical shock.

Do not keep or use flammable gases or combustibles near the air conditioner.

- Otherwise, it may cause a fire or the failure of product.

Ensure that an installation frame of the outdoor unit is not damaged due to use for a long time.

- It may cause injury or an accident.

Do not disassemble or repair the product randomly.

- It will cause a fire or electrical shock.

Do not install the product at a place that there is concern of falling down.

- Otherwise, it may result in personal injury.

Use caution when unpacking and installing.

- Sharp edges may cause injury.

■ Operation

Do not share the outlet with other appliances.

- It will cause an electric shock or a fire due to heat generation.

Do not use the damaged power cord.

- Otherwise, it may cause a fire or electrical shock.

Do not modify or extend the power cord randomly.

- Otherwise, it may cause a fire or electrical shock.

Take care so that the power cord may not be pulled during operation.

- Otherwise, it may cause a fire or electrical shock.

Unplug the unit if strange sounds, smell, or smoke comes from it.

- Otherwise, it may cause electrical shock or a fire.

Keep the flames away.

- Otherwise, it may cause a fire.

Take the power plug out if necessary, holding the head of the plug and do not touch it with wet hands.

- Otherwise, it may cause a fire or electrical shock.

Do not use the power cord near the heating tools.

- Otherwise, it may cause a fire and electrical shock.

Do not open the inlet of the indoor/outdoor unit during operation.

- Otherwise, it may cause electrical shock and failure.

Do not allow water to run into electrical parts.

- Otherwise, it may cause the failure of machine or electrical shock.

Hold the plug by the head when taking it out.

- It may cause electric shock and damage.

Never touch the metal parts of the unit when removing the filter.

- They are sharp and may cause injury.

Do not step on the indoor/outdoor unit and do not put anything on it.

- It may cause an injury through dropping of the unit or falling down.

Do not place a heavy object on the power cord.

- Otherwise, it may cause a fire or electrical shock.

When the product is submerged into water, always contact the service center.

- Otherwise, it may cause a fire or electrical shock.

Take care so that children may not step on the outdoor unit.

- Otherwise, children may be seriously injured due to falling down.

 **CAUTION**

■ Installation

Install the drain hose to ensure that drain can be securely done.

- Otherwise, it may cause water leakage.

Install the product so that the noise or hot wind from the outdoor unit may not cause any damage to the neighbors.

- Otherwise, it may cause dispute with the neighbors.

Always inspect gas leakage after the installation and repair of product.

- Otherwise, it may cause the failure of product.

Keep level parallel in installing the product.

- Otherwise, it may cause vibration or water leakage.

■ Operation

Avoid excessive cooling and perform ventilation sometimes.

- Otherwise, it may do harm to your health.

Use a soft cloth to clean. Do not use wax, thinner, or a strong detergent.

- The appearance of the air conditioner may deteriorate, change color, or develop surface flaws.

Do not use an appliance for special purposes such as preserving animals vegetables, precision machine, or art articles.

- Otherwise, it may damage your properties.

Do not place obstacles around the flow inlet or outlet.

- Otherwise, it may cause the failure of appliance or an accident.

Introduction

Symbols used in this Manual



This symbol alerts you to the risk of electric shock.



This symbol alerts you to hazards that may cause harm to the air conditioner.

NOTICE





This symbol indicates special notes.

The figure of product can be different according to the type of model.



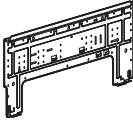





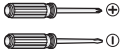

Installation

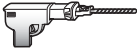
Read carefully, and then follow step by step.

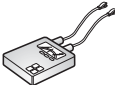
Installation Parts

<p>Installation plate</p>  <p>The feature can be changed according to a type of model.</p>		<p>Type "A" screw</p> 
<p>Type "B" screw</p> 	<p>Type "C" screw</p> 	<p>Remote control holder</p> 

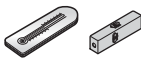
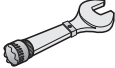
Installation Tools

Figure	Name	Figure	Name
	Screw driver		Multi-meter
	Electric drill		Hexagonal wrench
	Measuring tape, Knife		Ammeter
	Hole core drill		Gas-leak detector
	Spanner		Thermometer, Level
	Torque wrench		Flaring tool set

Installation Map

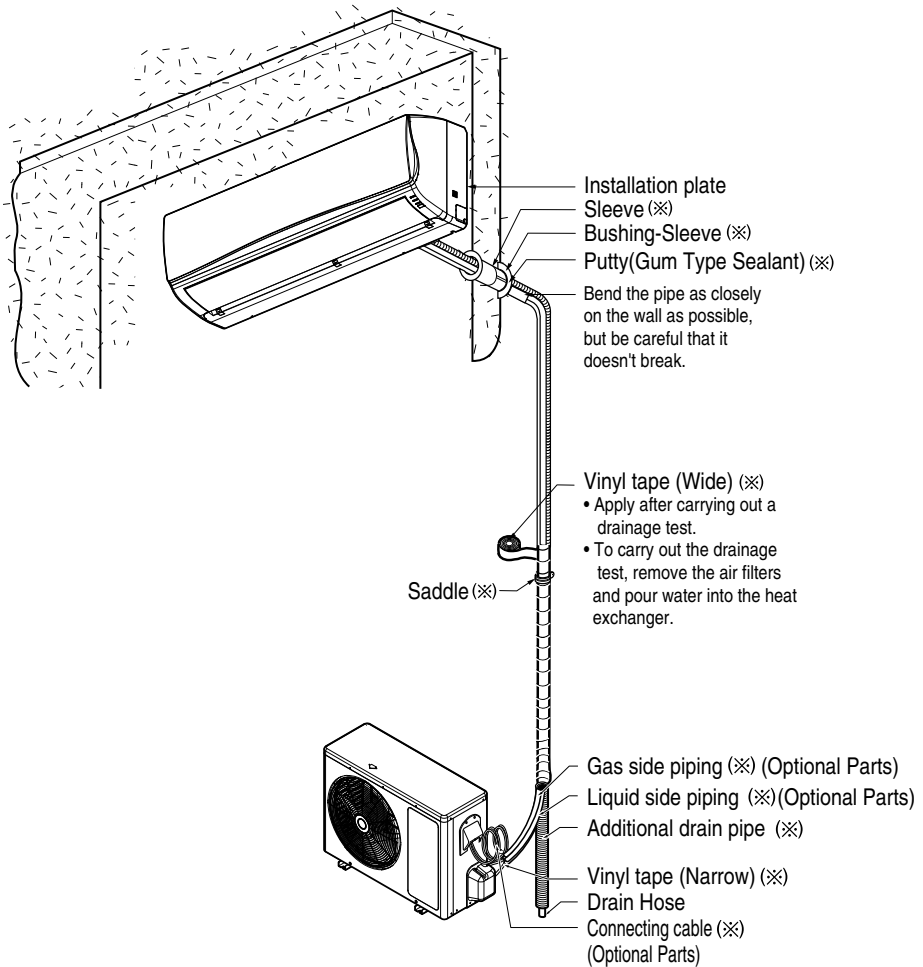

- The feature can be changed according a type of model.

NOTICE

(※) You should purchase the installation parts.

Select the best Location

Indoor unit

1. There should not be any heat or steam near the unit.
2. Select a place where there are no obstacles around of the unit.
3. Make sure that condensation drainage can be conveniently routed away.
4. Do not install near a doorway.
5. Ensure that the interval between a wall and the left (or right) of the unit is more than 10cm(3.9in). The unit should be installed as high as possible on the wall, allowing a minimum of 20cm(7.9in) from ceiling.
6. Use a metal detector to locate studs to prevent unnecessary damage to the wall.

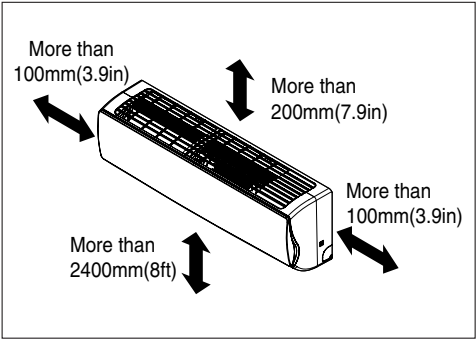

⚠ CAUTION

Install the indoor unit on the wall where the height from the floor is more than 2.4m(8ft).

Outdoor unit

1. If an awning is built over the unit to prevent direct sunlight or rain exposure, make sure that heat radiation from the condenser is not restricted.
2. Ensure that the space around the back and sides is more than 30cm(11.8in). The space in front of the unit should be more than 70cm(27.6in) of space.
3. Do not place animals and plants in the path of the warm air.
4. Take the weight of the air conditioner into account and select a place where noise and vibration are minimum.
5. Select a place where the warm air and noise from the air conditioner do not disturb neighbors.

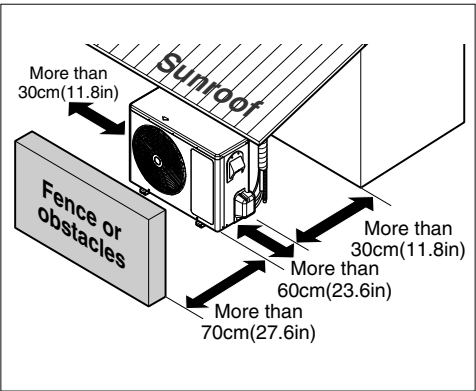

Flaring Work

Main cause for gas leakage is due to defect of flaring work. Carry out correct flaring work in the following procedure.

Cut the pipes and the cable.

1. Use the piping kit accessory or the pipes purchased locally.
2. Measure the distance between the indoor and the outdoor unit.
3. Cut the pipes a little longer than measured distance.
4. Cut the cable 1.5m(59.1in) longer than the pipe length.

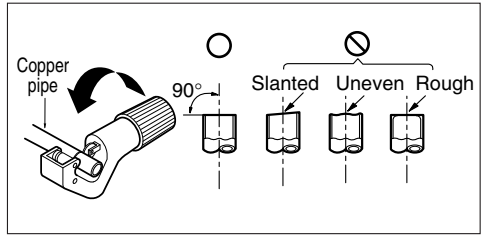

Burrs removal

1. Completely remove all burrs from the cut cross section of pipe/tube.
2. While removing burrs put the end of the copper tube/pipe in a downward direction while removing burrs location is also changed in order to avoid dropping burrs into the tubing.

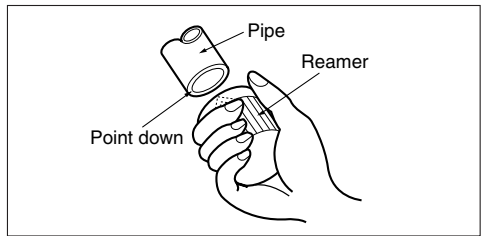

Putting nut on

- Remove flare nuts attached to indoor and outdoor unit, then put them on pipe/tube having completed burr removal. (not possible to put them on after finishing flare work)

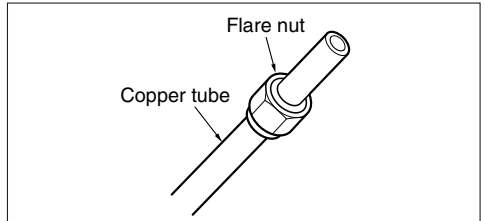

Flaring work

1. Firmly hold copper pipe in a bar with the dimension shown in table below.
2. Carry out flaring work with the flaring tool.

Outside diameter		A
mm	inch	mm
Ø6.35	1/4	1.1~1.3
Ø9.52	3/8	1.5~1.7
Ø12.7	1/2	1.6~1.8
Ø15.88	5/8	1.6~1.8
Ø19.05	3/4	1.9~2.1

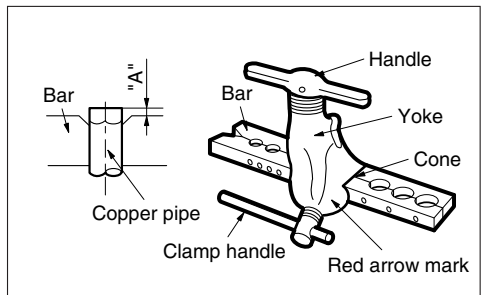

Check

1. Compare the flared work with the figure by.
2. If a flared section is defective, cut it off and do flaring work again.

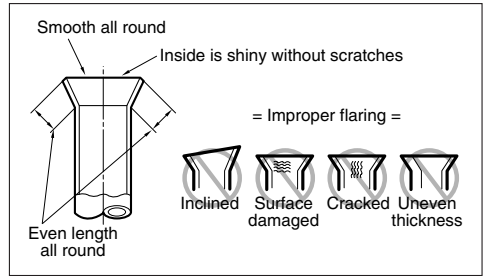

ENGLISH

Connecting the Piping

Indoor unit

1. Pull the screw cap at the bottom of the indoor unit
2. Remove the chassis cover from the unit by losing 3 screws

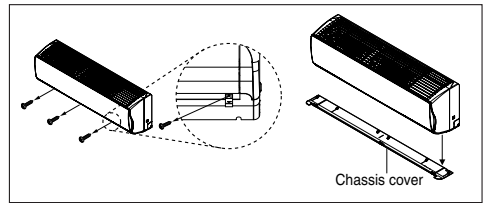

3. Pull back the tubing holder.
4. Remove pipe port cover and positioning the tubing

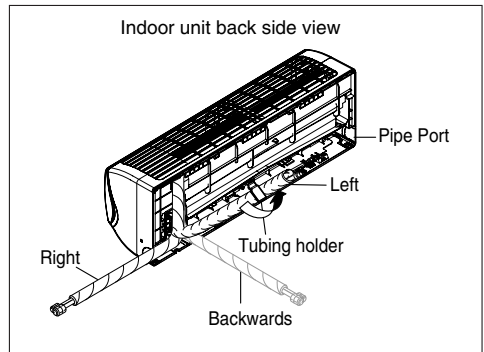

⚠ CAUTION

Installation Information. For right piping. Follow the instruction below.

Good case

- Press on the tubing cover and unfold the tubing to downward slowly. And then bend to the left side slowly.

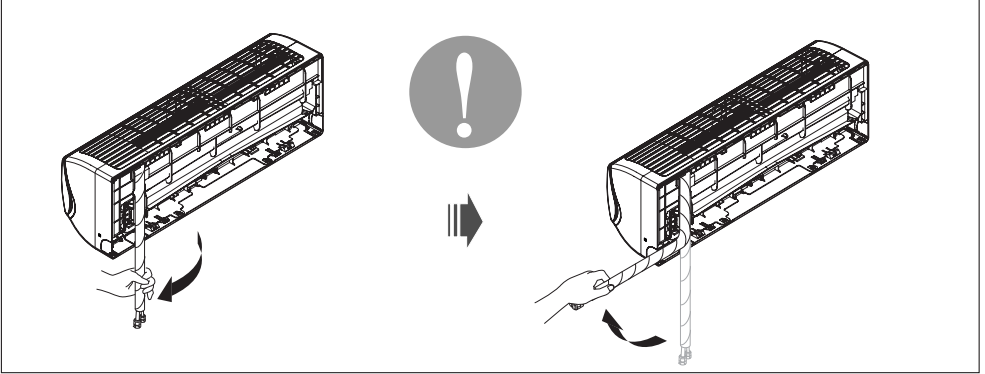

Bad case

- Following bending case from right to left directly may cause damage to the tubing.

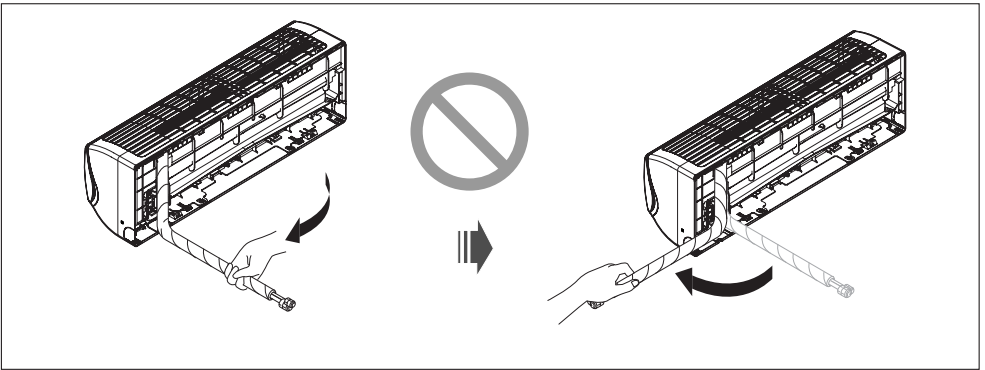

Installation of Indoor Unit

1. Hook the indoor unit onto the upper portion of the installation plate. (engage the three hooks at the top of the indoor unit with the upper edge of the installation plate) Ensure that the hooks are properly seated on the installation plate by moving it left and right

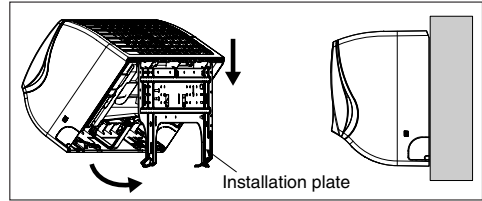

2. Unlock the tubing holder from the chassis and mount between the chassis and installation plate in order to separate the bottom side of the indoor unit from the wall

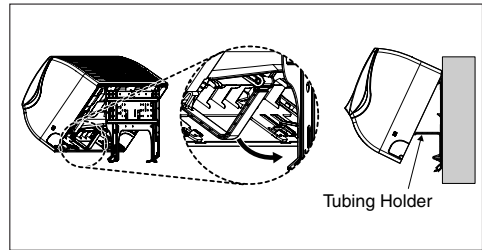

▲ CAUTION

If the drain hose is routed inside the room insulate the hose with an insulation material* so that dripping from sweating (condensation) will not damage furniture or floors.

Be sure to install in the sequence of Connecting cable (Conduit), Drain hose and Connecting pipe as the picture below describes.

* Foamed polyethylene or equivalent is recommended.

<Left side piping>

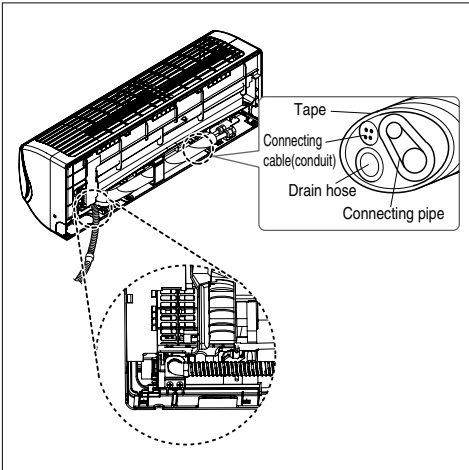

<Right side piping>

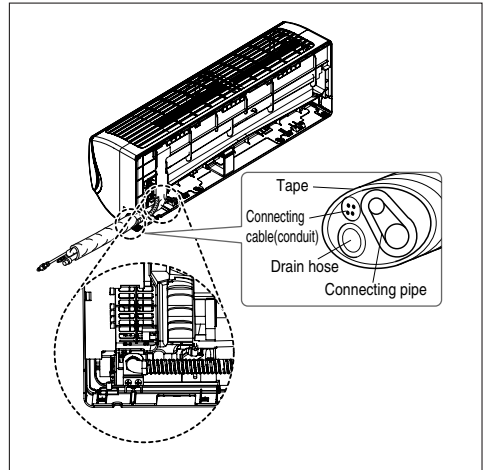

Connecting the installation pipe and drain hose to the indoor unit.

1. Align the center of the pipes and sufficiently tighten the flare nut by hand

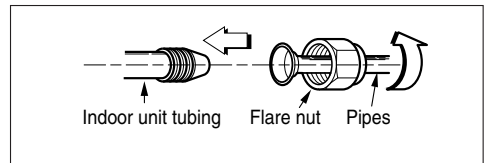

2. Tighten the flare nut with a wrench

Outside diameter		Torque	
mm	inch	kgf·m	lbf·ft
Ø6.35	1/4	1.8~2.5	13~18
Ø9.52	3/8	3.4~4.2	24.6~30.4
Ø12.7	1/2	5.5~6.6	39.8~47.7
Ø15.88	5/8	6.3~8.2	45.6~59.3

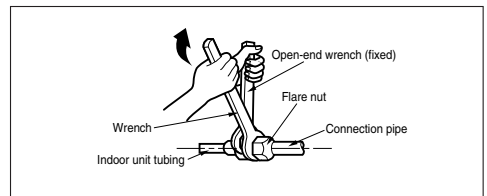

3. When needed to extend the drain hose of indoor unit, assemble the drain pipe as shown on the drawing

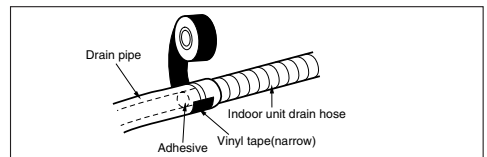

Wrap the insulation material around the connecting portion.

1. Overlap the connection pipe insulation material and the indoor unit pipe insulation material. Bind them together with vinyl tape so that there may be no gap.
2. Wrap the area which accommodates the rear piping housing section with vinyl tape.
3. Bundle the piping and drain hose together by wrapping them with vinyl tape sufficient enough to cover where they fit into the rear piping housing section.

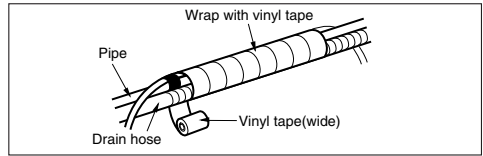
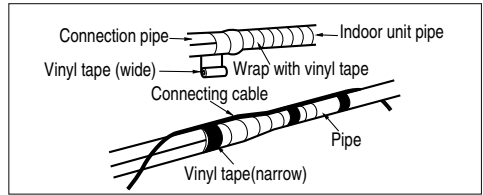
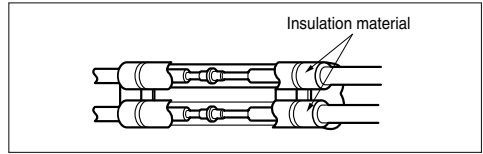

Finishing the indoor unit installation

1. Mount the tubing holder in the original position.
2. Ensure that the hooks are properly seated on the installation plate by moving it left and right.
3. Press the lower left and right sides of the unit against the installation plate until the hooks engage into their slots (clicking sound).
4. Finish the assembly by screwing the unit to the installation plate by using two pieces of type "C" screws. And assemble a chassis cover.

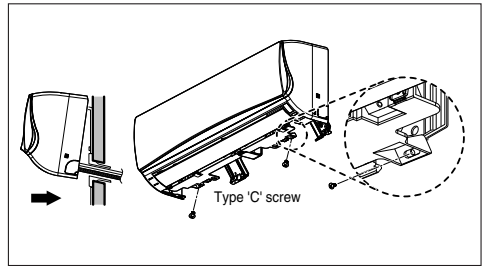

Installation of filters

1. Pull out the triple filter and allergy free filter from the separately packed plastic bag.
2. Insert the triple filter into the left case and insert the allergy free filter into the right case.
3. Detach two attached tapes from the plasma filter.

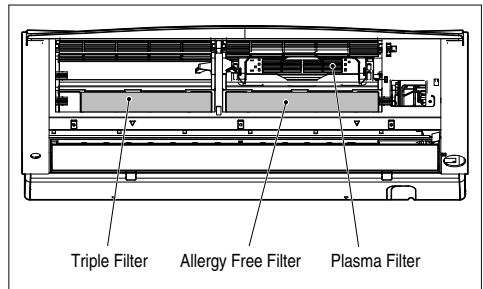

Outdoor unit

1. Remove the tubing cover from the unit by loosening the screw.

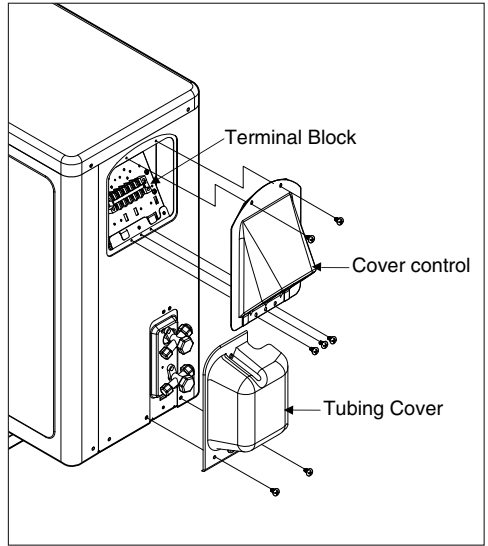

2. Align the center of the pipings and sufficiently tighten the flare nut by hand.

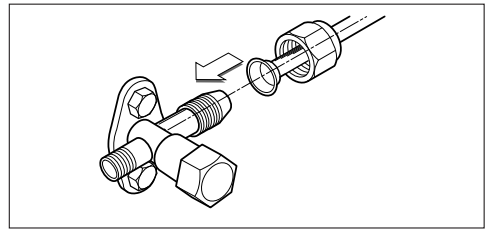

3. Finally, tighten the flare nut with torque wrench until the wrench clicks.
 - When tightening the flare nut with torque wrench, ensure the direction for tightening follows the arrow on the wrench.

Outside diameter		Torque	
mm	inch	kgf-m	lbf-ft
Ø6.35	1/4	1.8~2.5	13~18
Ø9.52	3/8	3.4~4.2	24.6~30.4
Ø12.7	1/2	5.5~6.6	39.8~47.7
Ø15.88	5/8	6.3~8.2	45.6~59.3
Ø19.05	3/4	9.9~12.1	71.6~87.5

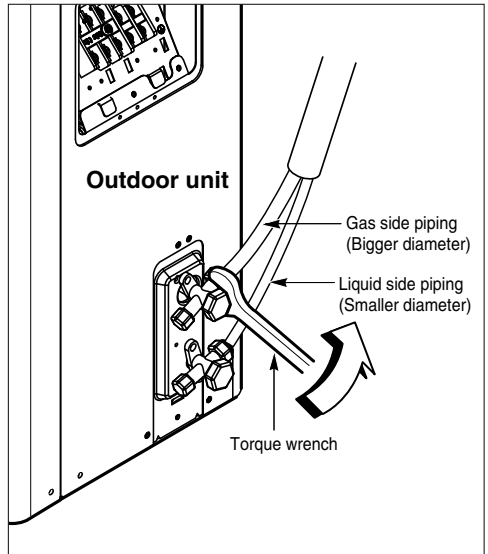

Connecting the Cables

Indoor

Connect the cable to the indoor unit by connecting the wires to the terminals on the control board individually according to the outdoor unit connection. (Ensure that the color of the wires of the outdoor unit and the terminal No. are the same as those of the indoor unit.)

⚠ CAUTION

- The circuit diagram is a subject to change without notice.
- The earth wire should be longer than the common wires.
- When installing, refer to the circuit diagram on the chassis cover.
- Connect the wires firmly so that they may not be pulled out easily.
- Connect the wires according to color codes, referring to the wiring diagram.

⚠ CAUTION

Provide a circuit breaker between power source and the outdoor unit as shown below.

Circuit Breaker (A)	Capacity(Btu/h)	
		18k
	20	25

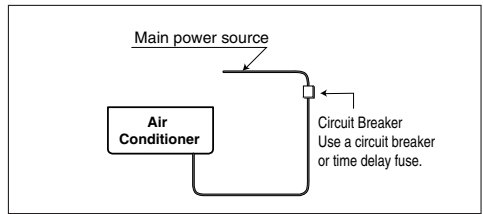

⚠ CAUTION

The power cord connected to the outdoor unit should be complied with the following specifications (UL recognized or CSA certified).

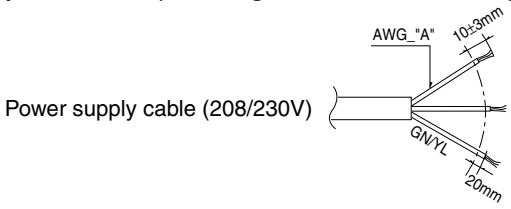

Power	Capacity(Btu/h)	
		18k
"A"	14	12

The power connecting cable connected to the indoor and outdoor unit should be complied with the following specifications (UL recognized or CSA certified).

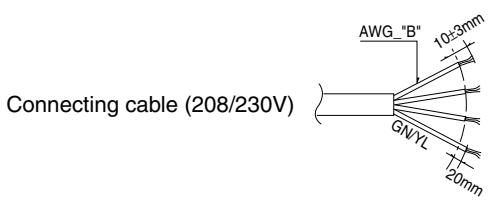

Power	Capacity(Btu/h)	
		18k/24k
"B"	18	

⚠ CAUTION

When using the separate wire as the power cord, please fix the separate wire into the control box panel by using tie wrap as the fixture.

Outdoor

1. Remove the cover control from the unit by loosening the screw.
Connect the wires to the terminals on the control board individually as the following.
2. Secure the cable onto the control board with the holder (clamer).
3. Refix the cover control to the original position with the screw.

Wiring Diagram

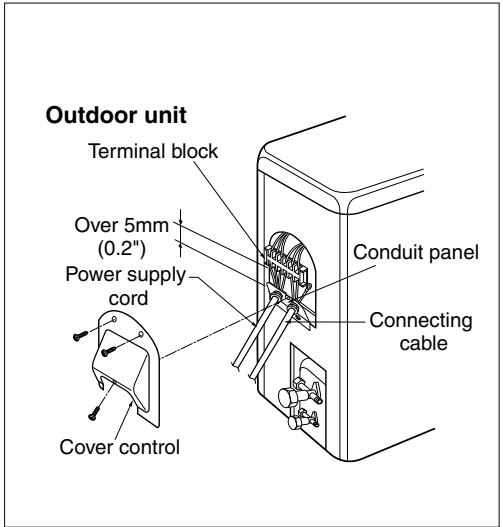
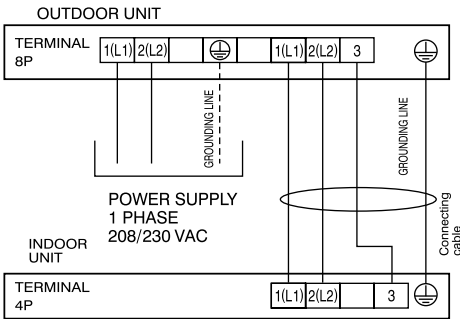

NOTICE

1. Separately wire power supply cord and connecting cable.
2. Use heat-proof electrical wiring capable of withstanding temperature up to 75°C(167°F).
3. Use outdoor and waterproof connection cable rated more than 300V for the connection between indoor and outdoor unit. (For example, Type SJO-WA)

⚠ WARNING

- Be sure to comply with local codes while running the wire from the indoor unit to the outdoor unit(size of wire and wiring method, etc).
- Every wire must be connected firmly.
- No wire should be allowed to touch refrigerant tubing, the compressor or any moving parts.

How to connect wiring to the terminals

■ For strand wiring

- (1) Cut the wire end with a wire cutter or wire-cutting pliers, then strip the insulation to expose the strand wiring about 10mm(3/8in).
- (2) Using a screwdriver, remove the terminal screw(s) on the terminal plate.
- (3) Using a round terminal fastener or pliers, securely clamp each stripped wire end with a round terminal.
- (4) Position the round terminal wire, and replace and tighten the terminal screw using a screwdriver.

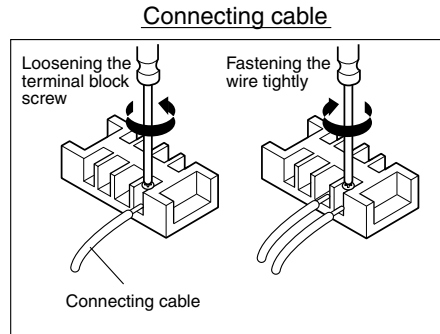
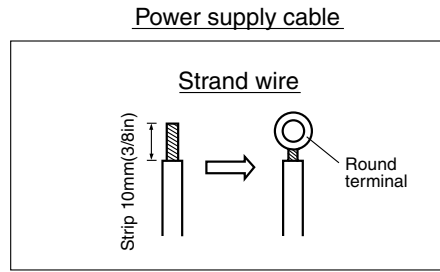

⚠ CAUTION

According to the confirmation of the above conditions, prepare the wiring as follows.

1. Never fail to have an individual power circuit specifically for the air conditioner. As for the method of wiring, be guided by the circuit diagram posted on the inside of control cover.
2. The screw which fasten the wiring in the casing of electrical fittings are liable to come loose from vibrations to which the unit is subjected during the course of transportation. Check them and make sure that they are all tightly fastened. (If they are loose, it could cause burn-out of the wires.)
3. Specification of power source.
4. Confirm that electrical capacity is sufficient.
5. See that the starting voltage is maintained at more than 90 percent of the rated voltage marked on the name plate.
6. Confirm that the cable thickness is as specified in the power source specification. (Particularly note the relation between cable length and thickness.)
7. Always install an earth leakage circuit breaker in a wet or moist area.
8. The following would be caused by voltage drop.
 - Vibration of a magnetic switch, which will damage the contact point, fuse breaking, disturbance of the normal function of the overload.
9. The means for disconnection from a power supply shall be incorporated in the fixed wiring and have an air gap contact separation of at least 3mm in each active(phase) conductors.

Checking the Drainage

To check the drainage.

1. Pour a glass of water on the evaporator.
2. Ensure the water flows through the drain hose of the indoor unit without any leakage and goes out the drain exit.

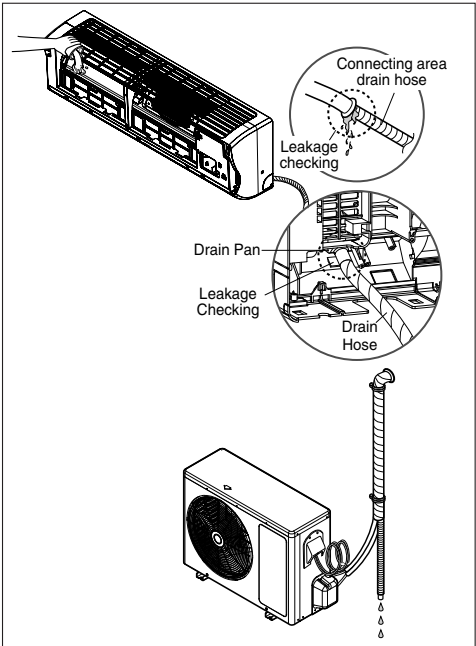

Drain piping

1. The drain hose should point downward for easy drain flow.

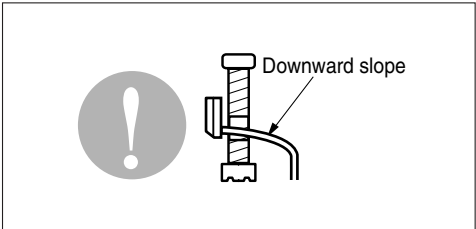

2. Do not make drain piping like the following.

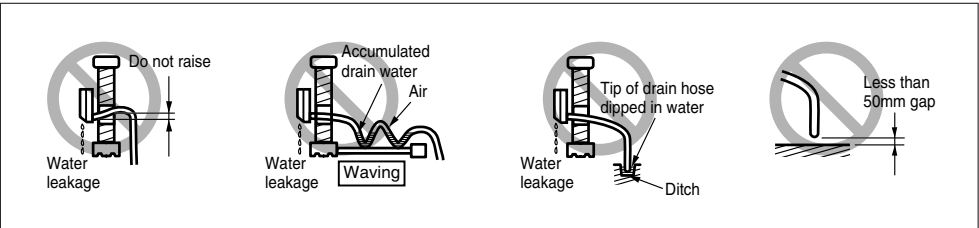

Forming the Piping

In cases where the outdoor unit is installed below the indoor unit perform the following.

1. Tape the piping, drain hose and connecting cable from down to up.
2. Secure the taped piping along the exterior wall using saddle or equivalent.

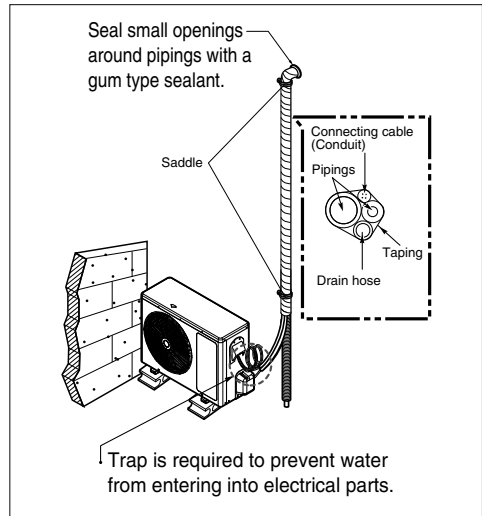

In cases where the Outdoor unit is installed above the Indoor unit perform the following.

1. Tape the piping and connecting cable from down to up.
2. Secure the taped piping along the exterior wall. Form a trap to prevent water entering the room.
3. Fix the piping onto the wall using saddle or equivalent.

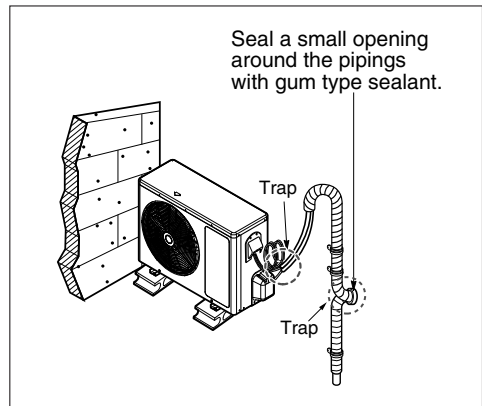

Air Purging

The air and moisture remaining in the refrigerant system have undesirable effects as indicated below.

1. Pressure in the system rises.
2. Operating current rises.
3. Cooling(or heating) efficiency drops.
4. Moisture in the refrigerant circuit may freeze and block capillary tubing.
5. Water may lead to corrosion of parts in the refrigeration system.

Therefore, after evacuating the system, take a leak test for the piping and tubing between the indoor and outdoor unit.

Air purging with vacuum pump

1. Preparation

- Check that each tube(both liquid and gas side tubes) between the indoor and outdoor units have been properly connected and all wiring for the test run has been completed. Remove the service valve caps from both the gas and the liquid side on the outdoor unit. Note that both the liquid and the gas side service valves on the outdoor unit are kept closed at this stage.

2. Leak test

- Connect the manifold valve(with pressure gauges) and dry nitrogen gas cylinder to this service port with charge hoses.

▲ CAUTION

Be sure to use a manifold valve for air purging. If it is not available, use a stop valve for this purpose. The knob of the 3-way valve must always be kept close.

- Pressurize the system to not more than 150 P.S.I.G. with dry nitrogen gas and close the cylinder valve when the gauge reading reaches 150 P.S.I.G. Next, test for leaks with liquid soap.

▲ CAUTION

To avoid nitrogen entering the refrigerant system in a liquid state, the top of the cylinder must be higher than its bottom when you pressurize the system. Usually, the cylinder is used in a vertical standing position.

1. Do a leak test of all joints of the tubing(both indoor and outdoor) and both gas and liquid side service valves.

Bubbles indicate a leak. Be sure to wipe off the soap with a clean cloth.

2. After the system is found to be free of leaks, relieve the nitrogen pressure by loosening the charge hose connector at the nitrogen cylinder. When the system pressure is reduced to normal, disconnect the hose from the cylinder.

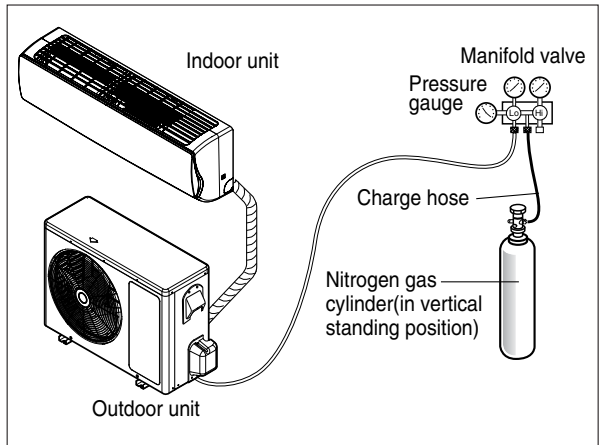

Soap water method

1. Remove the caps from the 2-way and 3-way valves.
2. Remove the service-port cap from the 3-way valve.
3. Apply a soap water or a liquid neutral detergent on the indoor unit connection or outdoor unit connections by a soft brush to check for leakage of the connecting points of the piping.
4. If bubbles come out, the pipes have leakage

Evacuation

1. Connect the charge hose end described in the preceding steps to the vacuum pump to evacuate the tubing and indoor unit. Confirm the "Lo" knob of the pressure Gauge is open. Then, run the vacuum pump. The operation time for evacuation varies with tubing length and capacity of the pump. The following table shows the time required for evacuation.

Required time for evacuation when 30 gal/h vacuum pump is used	
If tubing length is less than 10m (33 ft)	If tubing length is longer than 10m (33 ft)
10 min. or more	15 min. or more

2. When the desired vacuum is reached, close the knob of the 3-way valve and stop the vacuum pump.

Finishing the Job

1. With a service valve wrench, turn the valve of liquid side counter-clockwise to fully open the valve
2. Turn the valve of gas side counter clockwise to fully open the valve
3. Loosen the charge hose connected to the gas side service port slightly to release the pressure, then remove the hose.
4. Replace the flare nut and its bonnet on the gas side service port and fasten the flare nut securely with an adjustable wrench. This process is very important to prevent leakage from the system
5. Replace the valve caps at both gas and liquid side service valves and fasten them tight. This completes air purging with a vacuum pump.

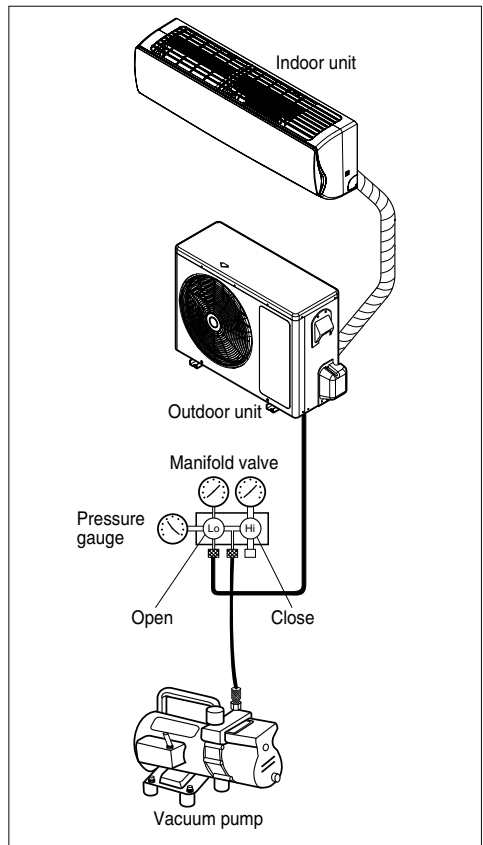
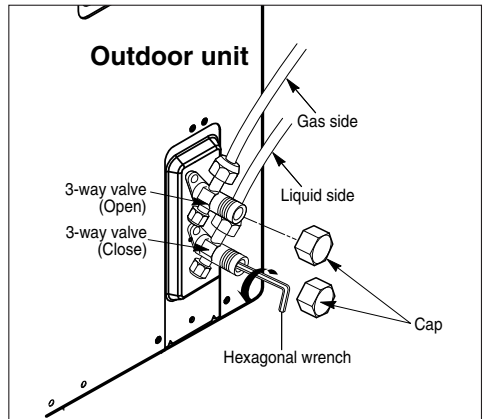

6. Replace the pipe cover to the outdoor unit by one screw
Now the air conditioner is ready for test run.

Test Running

1. Check that all tubing and wiring are properly connected.
2. Check that the gas and liquid side service valves are fully open.

Prepare remote controller

1. Remove the battery cover by pulling it according to the arrow direction.
2. Insert new batteries making sure that the (+) and (-) of battery are installed correctly.
3. Reattach the cover by pushing it back into position.

NOTICE

- Use 2 AAA(1.5volt) batteries. Do not use rechargeable batteries.
- Remove the batteries from the remote controller if the system is not used for a long time.

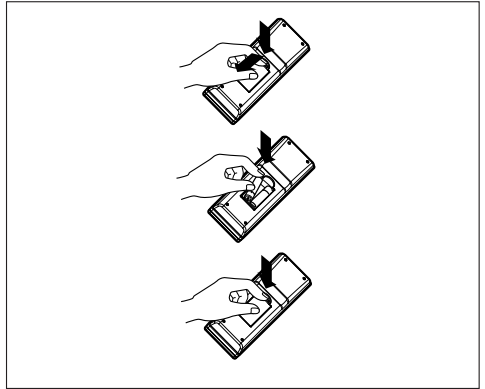

Settlement of outdoor unit

1. Fix the outdoor unit with a bolt and nut($\phi 10\text{mm}$) tightly and horizontally on a concrete or rigid mount.
2. When installing on the wall, roof or rooftop, anchor the mounting base securely with a nail or wire assuming the influence of wind and earthquake.
3. If the vibration of the unit is transmitted to the pipe, secure the unit with an anti-vibration rubber.

Evaluation of the performance

Operate the unit for 15~20 minutes, then check the system refrigerant charge:

1. Measure the pressure of the gas side service valve.
2. Measure the air temperature from inlet and outlet of air conditioner.
3. Ensure the difference between the inlet and outlet temperature is more than $8^{\circ}\text{C}(46.4^{\circ}\text{F})$.
4. For reference; the gas side pressure at optimum condition is shown on table (cooling)

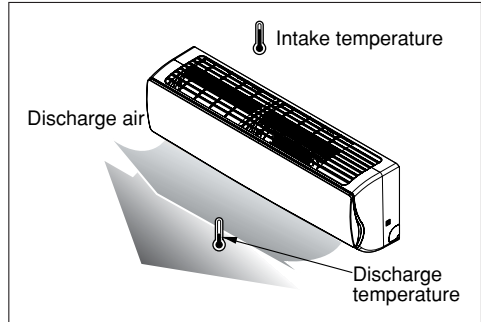
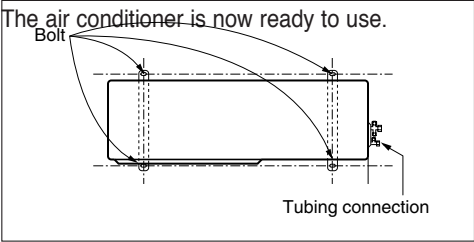

Refrigerant	Outside ambient TEMP.	The pressure of the gas side
R-410A	$35^{\circ}\text{C}(95^{\circ}\text{F})$	$8.5\sim 9.5\text{kg}/\text{cm}^2\text{G}(120\sim 135\text{ P.S.I.G.})$

NOTICE

If the actual pressure is higher than shown, the system is most likely over-charged, and charge should be removed. If the actual pressure are lower than shown, the system is most likely undercharged, and charge should be added.

PUMP DOWN

This is performed when the unit is relocated or the refrigerant circuit is serviced.

Pump Down means collecting all refrigerant into the outdoor unit without the loss of refrigerant.

CAUTION

Be sure to perform Pump Down procedure in the cooling mode.

Pump Down Procedure

1. Connect a low-pressure gauge manifold hose to the charge port on the gas side service valve.
2. Open the gas side service valve halfway and purge the air in the manifold hose using the refrigerant.
3. Close the liquid side service valve(all the way).
4. Turn on the unit's operating switch and start the cooling operation.
5. When the low-pressure gauge reading becomes 1 to $0.5\text{kg}/\text{cm}^2\text{ G}(14.2$ to $7.1\text{ P.S.I.G.})$, fully close the gas side valve and then quickly turn off the unit. Now Pump Down procedure is completed, and all refrigerant is collected into the outdoor unit.

Installation guide at the seaside

⚠ CAUTION

1. Air conditioners should not be installed in areas where corrosive gases, such as acid or alkaline gas, are produced.
2. Do not install the product where it could be exposed to sea wind (salty wind) directly. It can result corrosion on the product. Corrosion, particularly on the condenser and evaporator fins, could cause product malfunction or inefficient performance.
3. If outdoor unit is installed close to the seaside, it should avoid direct exposure to the sea wind. Otherwise it needs additional anticorrosion treatment on the heat exchanger.

Selecting the location(Outdoor Unit)

1) If the outdoor unit is to be installed close to the seaside, then direct exposure to the sea wind should be avoided. Install the outdoor unit on the opposite side of the sea wind direction.

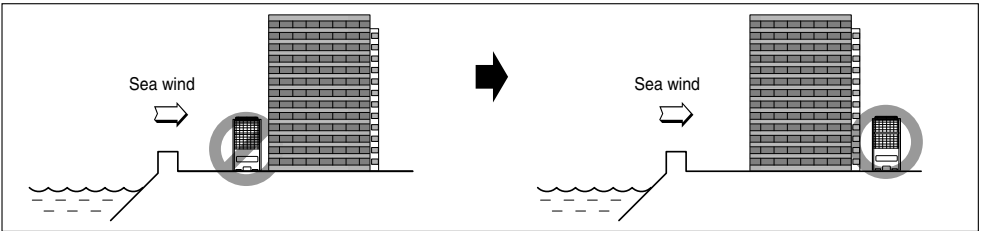

2) In case of installing the outdoor unit on the sea side, setup a windbreak to prevent sea wind.

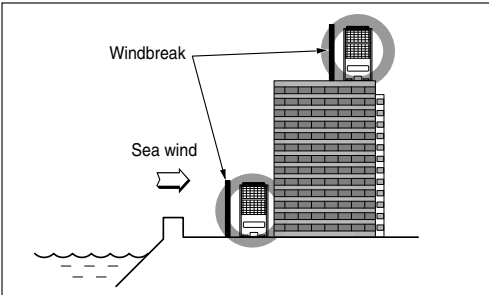

- It should be strong enough like concrete to prevent the sea wind from the sea.
- The height and width should be more than 150% of the outdoor unit.
- Keep more than 70 cm of space between outdoor unit and the windbreak for easy air flow.

3) Select a well-drained place.

1. If you can't meet above guide line in the seaside installation, please contact LG Electronics for the additional anticorrosion treatment.
2. Periodic (more than once/year) cleaning of the dust or salt particles stuck on the heat exchanger by using water

Piping Length and Elevation

Capacity (Btu/h)	Pipe Size				Standard Length m (ft)	Max. Elevation Ⓑ m(ft)	Max. Length Ⓐ m(ft)	Additional Refrigerant (g/m)
	GAS		LIQUID					
	mm	inch	mm	inch				
18k	Ø12.7	1/2	Ø6.35	1/4	7.5(25)	15(50)	30(99)	20
24k	Ø15.88	5/8	Ø9.52	3/8	7.5(25)	15(50)	30(99)	35

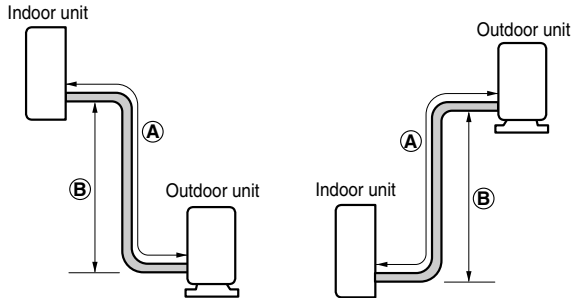

⚠ CAUTION

Capacity is based on standard length and maximum allowable length is on the basis of reliability. Additional refrigerant must be charged after 7.5m(25ft).



LGEUS
LG Electronics, Air conditioning Division
1000 Sylvan Ave., Englewood Cliffs, NJ 07632

LGECI
LG Electronics Canada Inc.
550 Matheson Blvd. East, Mississauga, Ontario, L4Z 4G3

LG Customer Information Center

888-865-3026 USA, press #2 for PTAC, TTW
888-865-3026 USA, press #3 for DFS, Multi V
1-888-LG-Canada CANADA

Register your product Online!

www.lge.com