

INSTALLATION INSTRUCTIONS

SINGLE SPLIT WALL MOUNTED AIR CONDITIONER

- Please read this instruction sheet completely before installing the product.
- When the power cord is damaged, replacement work shall be performed by authorized personnel only.
- Installation work must be performed in accordance with the national wiring standards by authorized personnel only.

Installation Parts Provided

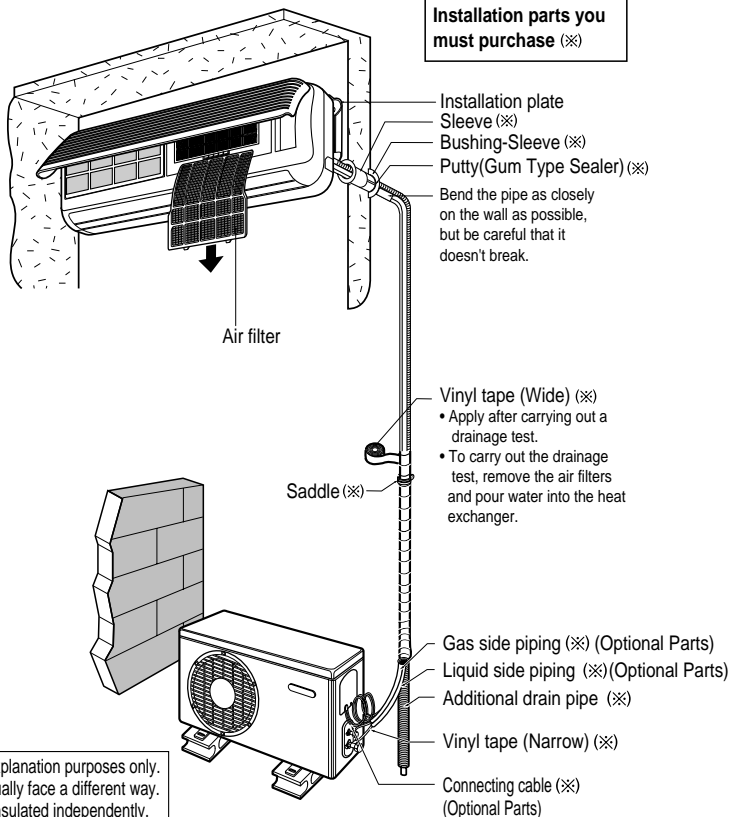
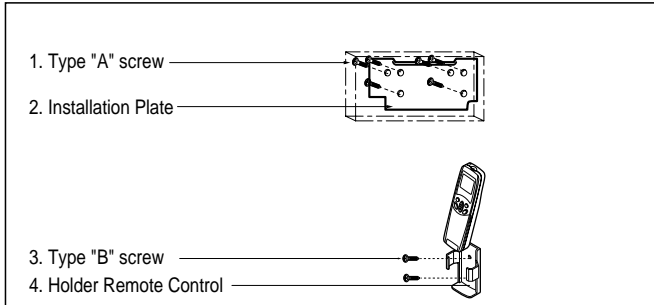

- This illustration is for explanation purposes only.
- The indoor unit will actually face a different way.
- Copper lines must be insulated independently.

INSTALLATION OVERVIEW

Installation Requirements

The following should be always observed for safety.....3

Installation of indoor, outdoor unit.....4

Flaring work and connection of piping6
Connection of piping(Indoor)7
For right rear piping
For left rear piping
Connection of piping(Outdoor)10

Connecting the cable between indoor unit and outdoor unit11

Checking the drainage and forming the piping14

Air purging15

Test running17

Required Parts

- Installation plate
- Four type "A" screws
- Connecting cable

- Pipes: Gas side1/2"(9K,12K)
5/8"(18K,24K)
Liquid side.....1/4"(9K,12K,18K)
3/8"(24K)
(Refer to page 4)
- Insulation materials
- Additional drain pipe
(Outer Diameter.....15.5mm)

Required Tools

- Level gauge
- Screw driver
- Electric drill
- Hole core drill \varnothing 70mm(2.79")

- Flaring tool set
- Specified torque wrenches
Liquid side - 1.8kg·m(13ft·lbs):9K,12K,18K
4.0kg·m(28.9ft·lbs):24K
Gas side - 5.5kg·m(39.8ft·lbs):9K, 12K
6.6kg·m(47.7ft·lbs):18K, 24K
- Spanner.....Half union

- A glass of water
- Screw driver

- Hexagonal wrench(4mm: 5.32")
- Gas-leak detector
- Vacuum pump
- Gauge manifold

- Owner's manual
- Thermometer
- Holder Remote Control

THE FOLLOWING SHOULD BE ALWAYS OBSERVED FOR SAFETY

- Be sure to read "THE FOLLOWING SHOULD BE ALWAYS OBSERVED FOR SAFETY" before installing the air conditioner.
- Be sure to observe the cautions specified here as they include important items related to safety.
- The indications and meanings are as follows.



WARNING

: Could lead to death, serious injury, etc.



CAUTION

: Could lead to serious injury in particular environments when operated incorrectly.

- After reading these instructions, be sure to keep it together with the owner's manual in a handy place on the customer's site.



WARNING

Do not install it yourself (customer).

Incorrect installation could cause injury due to fire, electric shock, the unit falling or leakage of water. Consult the dealer from whom you purchased the unit or special installer.

Install the unit securely in a place which can bear the weight of the unit's.

When installed in an insufficiently strong place, the unit could fall causing injury.

Use the specified wires to connect the indoor and outdoor units securely and attach the wires firmly to the terminal board connecting sections so the stress of the wires is not applied to the sections.

Incorrect connection and attachment could cause fire.

Attach the electrical part cover to the indoor unit and the service panel to the outdoor unit securely.

If the electrical part covers of the indoor unit and/or the service panel of the outdoor unit are not attached securely, it could result in a fire or electric shock due to dust, water, etc.

Perform the installation securely referring to the installation instruction.

Incorrect installation could cause a personal injury due to fire, electric shock, the unit falling or leakage of water.

Perform electrical work according to the installation manual and be sure to use a dedicated circuit.

If the capacity of the power circuit is insufficient or there is incomplete electrical work, it could result in a fire or an electric shock.

Check that the refrigerant gas does not leak after installation is completed.

Be sure to use the part provided or specified parts for the installation work.

The use of defective parts could cause an injury due to a fire, electric shock, the unit's falling, etc.



CAUTION

Do not install the unit in a place where a flammable gas leaks.

If gas leaks and accumulates in the area surrounding the unit, it could cause an explosion.

Perform the drainage/piping work according to the installation instruction.

If there is a defect in the drainage/piping work, water could leak from the unit and household goods could come wet and be damaged.

INSTALLATION OF INDOOR, OUTDOOR UNIT

Read completely, then follow step by step.

1 Select the best location

A Indoor unit

- Do not have any heat or steam near the unit.
- Select a place where there are no obstacles in front of the unit.
- Make sure that condensation drainage can be conveniently routed away. Do not install near a doorway.
- Ensure that the space around the left and right of the unit is more than "A". The unit should be installed as high on the wall as possible, allowing a minimum of "B" from ceiling.
- Use a stud finder to locate studs to prevent unnecessary damage to the wall.

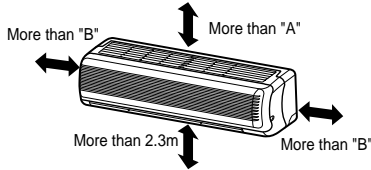

CAUTION

Install the indoor unit on the wall where the height from the floors more than 2.3 meters.

B Outdoor unit

- If an awning is built over the unit to prevent direct sunlight or rain exposure, make sure that heat radiation from the condenser is not restricted.
- Ensure that the space around the back and sides is more than 10cm. The front of the unit should have more than 70cm of space.
- Do not place animals and plants in the path of the warm air.
- Take the air conditioner weight into account and select a place where noise and vibration are minimum.
- Select a place so that the warm air and noise from the air conditioner do not disturb neighbors.

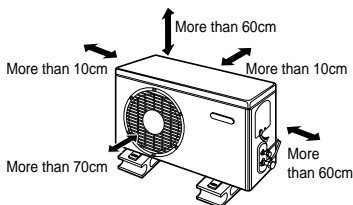

C Rooftop Installations:

- If the outdoor unit is installed on a roof structure, be sure to level the unit. Ensure the roof structure and anchoring method are adequate for the unit location.
- Consult local codes regarding rooftop mounting.

2 Piping length and elevation

MODEL (Cooling Capa.)	Pipe Size		Max. length A	Max. Elevation B
	GAS	LIQUID		
9K, 12K	1/2"	1/4"	15m(50ft)	8m(26ft)
18K	5/8"	1/4"	15m(50ft)	8m(26ft)
24K	5/8"	3/8"	15m(50ft)	8m(26ft)

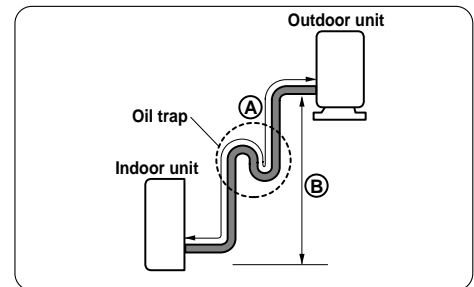
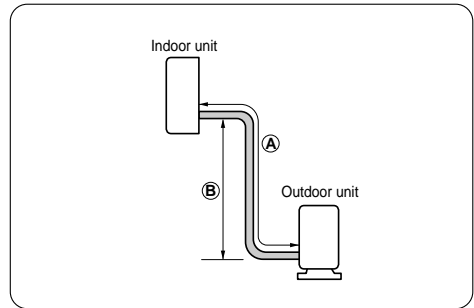

If case more than 5m

CAUTION

- Capacity is based on standard length and maximum allowance length is on the basis of reliability.
- Oil trap should be installed every 5~7 meters.

3

How to fix installation plate

The wall you select should be strong and solid enough to prevent vibration

A Mount the installation plate on the wall with 6 type "A" screws. If mounting the unit on a concrete wall, use anchor bolts.

■ Mount the installation plate horizontally by aligning the centerline using a level.

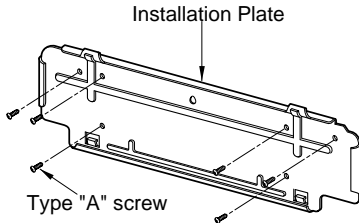

B Measure the wall and mark the centerline. It is also important to use caution concerning the location of the installation plate—routing of the wiring to power outlets is through the walls typically. Drilling the hole through the wall for piping connections must be done safely.

4

Drill a hole in the wall

■ Drill the piping hole with a $\phi 70\text{mm}$ hole core drill. Drill the piping hole at either the right or the left with the hole slightly slanted to the outdoor side.

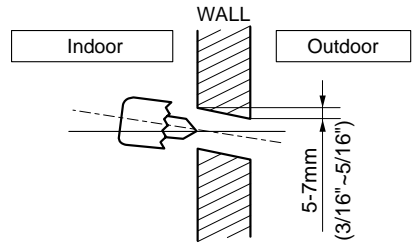

9K Btu

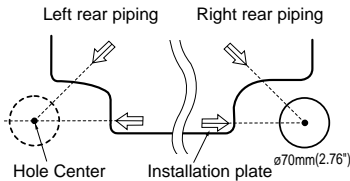

12K Btu

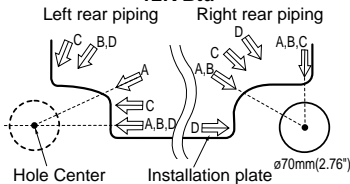

18K, 24K Btu

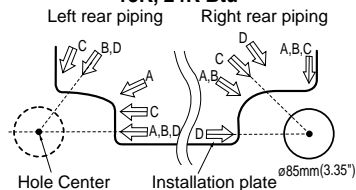

FLARING WORK AND CONNECTION OF PIPING



Flaring work

Main cause for refrigerant leakage is due to defect in the flaring work. Carry out correct flaring work using the following procedure.

A Cut the pipes and the cable.

- Use the piping kit accessory or pipes purchased locally.
- Measure the distance between the indoor and the outdoor unit.
- Cut the pipes a little longer than the measured distance.
- Cut the cable 1.5m longer than the pipe length.

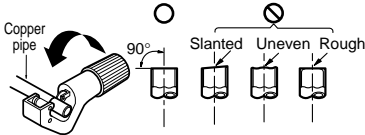

B Burr removal

- Completely remove all burrs from the cut cross section of pipe/tube.
- Put the end of the copper tube/pipe in a downward direction as you remove burrs in order to avoid dropping burrs into the tubing.

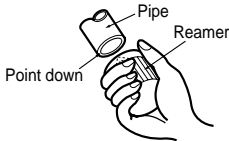

C Putting nut on

- Remove flare nuts attached to indoor and outdoor unit, then put them on pipe/tube having completed burr removal. (not possible to put them on after flaring work)

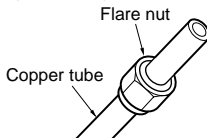

D Flaring work

- Firmly hold copper pipe in a die in the dimension shown in the table above.

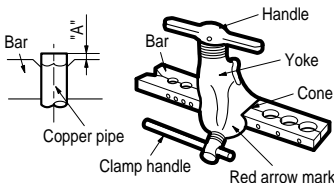

- Carry out flaring work using flaring tool as shown below.

Outside diameter		A
mm	inch	mm
Ø6.35	1/4	0~0.5
Ø9.52	3/8	0~0.5
Ø12.7	1/2	0~0.5
Ø15.88	5/8	0~1.0

E Check

- Compare the flared work with figure below.
- If flare is noted to be defective, cut off the flared section and re-flare it.

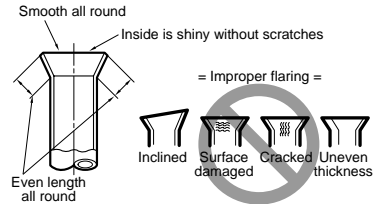

2

Connection of piping -- Indoor

- Preparing the indoor unit's piping and drain hose for installation through the wall.
- Remove the plastic tubing retainer (see illustration below) and pull the tubing and drain hose away from chassis.
- Replace the plastic tubing holder in the original position. (Optional)

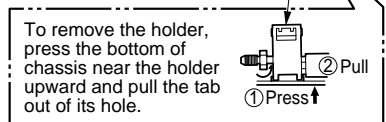
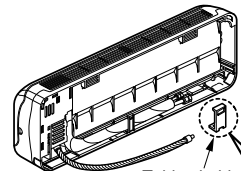

CAUTION

When install, make sure that the remaining parts must be removed clearly so as not to damage the piping and drain hose, especially power cord and connecting cable.

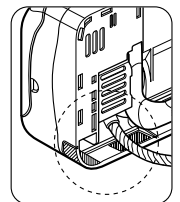

For right rear piping

A Route the indoor tubing and the drain hose in the direction of rear right.

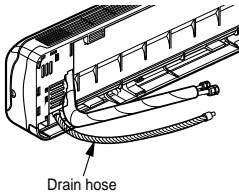

B Insert the connecting cable into the indoor unit from the outdoor unit through the piping hole.

- Do not connect the cable to the indoor unit.
- Make a small loop with the cable for easy connection later.

C Tape the tubing, drain hose, and the connecting cable. Be sure that the drain hose is located at the lowest side of the bundle. Locating at the upper side can cause drain pan to overflow inside the unit.

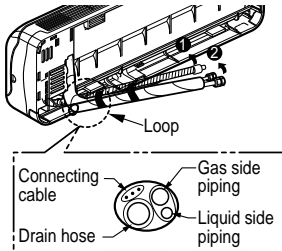

NOTE: If the drain hose is routed inside the room, insulate the hose with an insulation material* so that dripping from "sweating"(condensation) will not damage furniture or floors.

*Foamed polyethylene or equivalent is recommended.

D Indoor unit installation

- Hook the indoor unit onto the upper portion of the installation plate.(Engage the two hooks of the rear top of the indoor unit with the upper edge of the installation plate.) Ensure that the hooks are properly seated on the installation plate by moving it left and right.

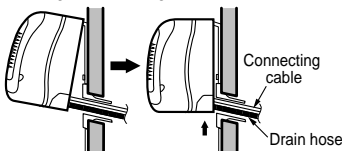

Press the lower left and right sides of the unit against the installation plate until the hooks engage into their slots(clicking sound).

E Connecting the pipings to the indoor unit and drain hose to drain pipe.

- Align the center of the pipes and sufficiently tighten the flare nut by hand.

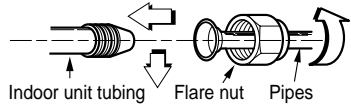

- Tighten the flare nut with a wrench.

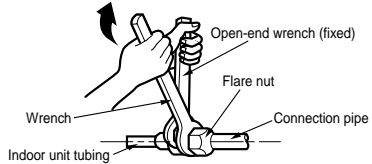

Capacity (Btu/h)	Pipe Size[Torque]	
	GAS	LIQUID
9K	1/2"[5.5kg·m]	1/4"[1.8kg·m]
12K	1/2"[5.5kg·m]	1/4"[1.8kg·m]
18K	5/8"[6.6kg·m]	1/4"[1.8kg·m]
24K	5/8"[6.6kg·m]	3/8"[4.2kg·m]

- When extending the drain hose at the indoor unit, install the drain pipe.

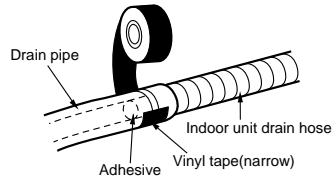

F Wrap the insulation material around the connecting portion.

- Overlap the connection pipe insulation material and the indoor unit pipe insulation material. Bind them together with vinyl tape so that there is no gap.

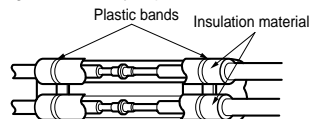

- Wrap the area which accommodates the rear piping housing section with vinyl tape.

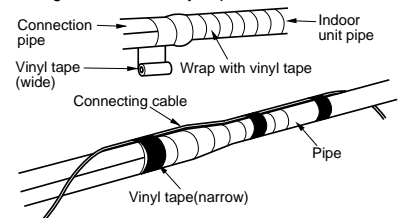

- Bundle the piping and drain hose together by wrapping them with vinyl tape for enough to cover where they fit into the rear piping housing section.

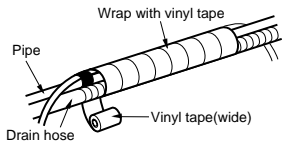

For left rear piping

- A** Route the indoor tubing and the drain hose to the required piping hole position.

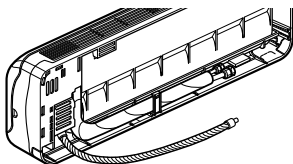

- B** Insert the piping, drain hose, and the connecting cable into the piping hole.

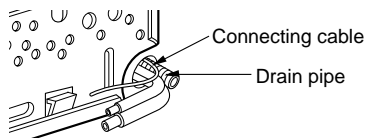

- C** Insert the connecting cable into the indoor unit.

- Don't connect the cable to the indoor unit.
- Make a small loop with the cable for easy connection later.

- D** Tape the drain hose and the connecting cable.

- Connecting cable

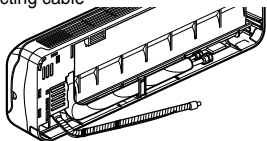

- E** Indoor unit installation

- Hang the indoor unit from the hooks at the top of the installation plate.
- Insert the spacer etc. between the indoor unit and the installation plate and separate the bottom of the indoor unit from the wall.

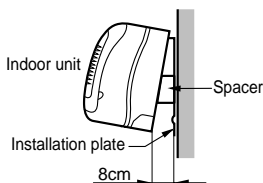

- F** Connecting the pipings to the indoor unit and the drain hose to drain pipe.

- Align the center of the pipes and sufficiently tighten the flare nut by hand.

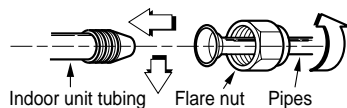

- Tighten the flare nut with a wrench.

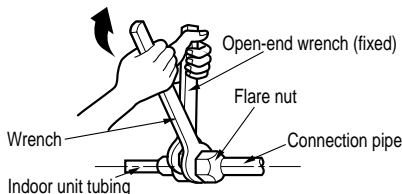

Capacity (Btu/h)	Pipe Size[Torque]	
	GAS	LIQUID
9K	1/2"[5.5kg·m]	1/4"[1.8kg·m]
12K	1/2"[5.5kg·m]	1/4"[1.8kg·m]
18K	5/8"[6.6kg·m]	1/4"[1.8kg·m]
24K	5/8"[6.6kg·m]	3/8"[4.2kg·m]

- When extending the drain hose at the indoor unit, install the drain pipe.

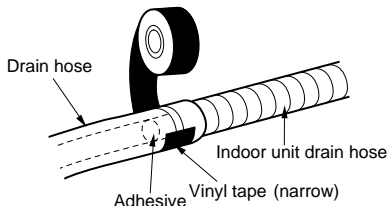

- G** Wrap the insulation material around the connecting portion.

- Overlap the connection pipe heat insulation and the indoor unit pipe heat insulation material. Bind them together with vinyl tape so that there is no gap.

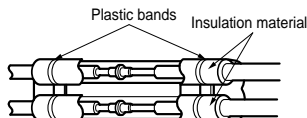

- Wrap the area which accommodates the rear piping housing section with vinyl tape.

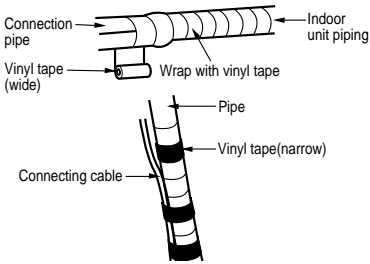

- Bundle the piping and drain hose together by wrapping them with cloth tape over the range within which they fit into the rear piping housing section.

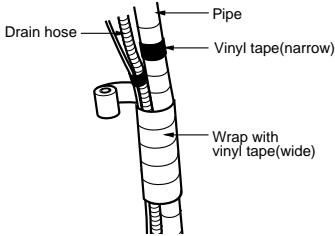

H Reroute the pipings and the drain hose across the back of the chassis.

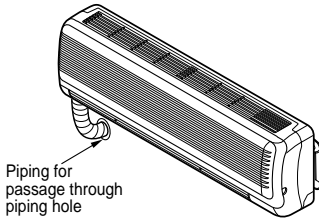

I Set the pipings and the drain hose to the back of the chassis with the tubing holder.

- Hook the edge of tubing holder to tap on chassis and push the bottom of tubing holder to be engaged at the bottom of chassis.

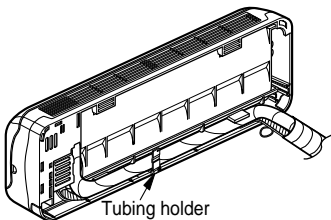

J Indoor unit installation

- Remove the spacer.
- Ensure that the hooks are properly seated on the installation plate by moving it left and right.

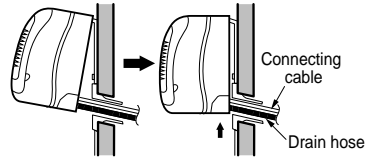

Press the lower left and right sides of the unit against the installation plate until the hooks engage into their slots (clicking sound).

CAUTION

Installation Information (For left piping)

• Good case

For left piping, Follow the instruction below.

- Press on the upper side of clamp. (A)

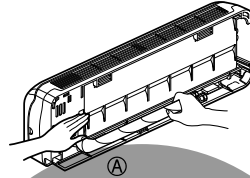

- Unfold the tubing to downward slowly. (B)

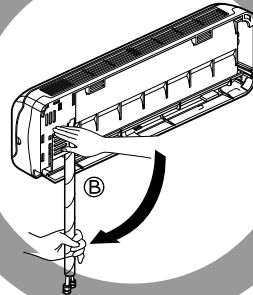

- Bend the tubing to the left side of chassis.

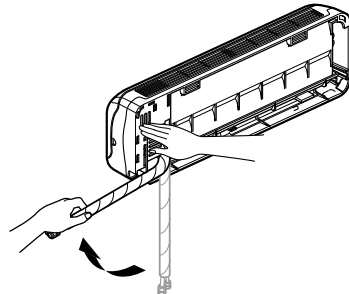

CAUTION

• **Bad case**

- Following bending type from right to left could cause problem of pipe damage.

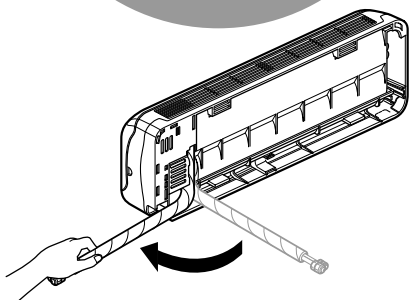
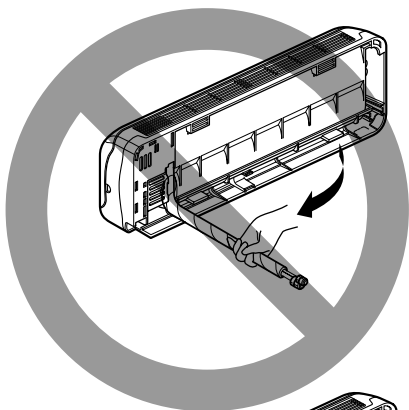
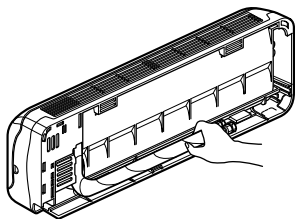

3 Connection of the pipes-Outdoor

- A** Align the center of the pipings and sufficiently tighten the flare nut by hand.

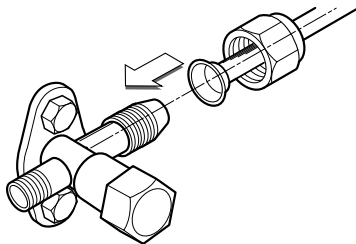

- B** Finally, tighten the flare nut with torque wrench until the wrench clicks.

- When tightening the flare nut with torque wrench, ensure the direction for tightening follows the arrow on the wrench.

Capacity (Btu/h)	Pipe Size[Torque]	
	GAS	LIQUID
9K	1/2"[5.5kg-m]	1/4"[1.8kg-m]
12K	1/2"[5.5kg-m]	1/4"[1.8kg-m]
18K	5/8"[6.6kg-m]	1/4"[1.8kg-m]
24K	5/8"[6.6kg-m]	3/8"[4.2kg-m]

Outdoor unit

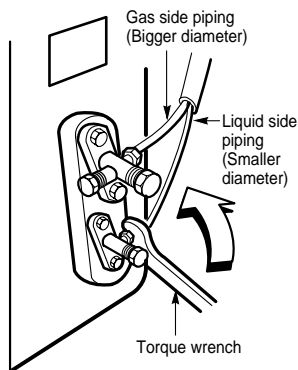

1 Connection of the cable

1. Remove the cover control from the unit by loosening the 3 screws.
2. Dismount caps on the conduit panel.
3. Temporarily mount the conduit tubes on the conduit panel.
4. Properly connect both the power supply and low voltage lines to the corresponding terminals on the terminal block.
5. Ground the unit in accordance with local codes.
6. Be sure to size each wire allowing several inches longer than the required length for wiring.
7. Use lock nuts to secure the conduit tubes.

NOTE

Connector trade size for this unit is 1/2". Refer to "How to connect wiring to the terminals" for instructions on connecting depending on the wire type you are using.



WARNING

- Be sure to comply with local codes while running the wire from the indoor unit to the outdoor unit (size of wire and wiring method, etc).
- Every wire must be connected firmly.
- No wire should be allowed to touch refrigerant tubing, the compressor or any moving parts.

Power Supply

Model	Power source	AWG(MIN.)		Fuse or breaker Capacity
		Ⓐ	Ⓑ	
9K	1ø, 115V	14	18	15A
12K	1ø, 115V	14	18	20A
18K	1ø, 230/208V	14	18	20A
24K	1ø, 230/208V	12	18	25A

Wiring Diagram

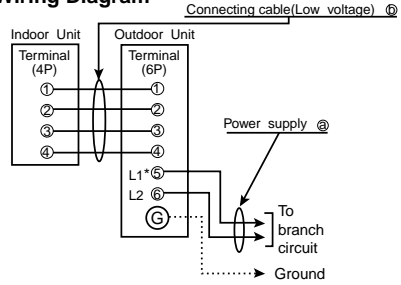

NOTE

1. shows field wiring.
2. Separately wire the high and low voltage line.
3. Use heat-proof electrical wiring capable of withstanding temperatures up to 167°F.
4. Use outdoor and waterproof connection cable rated more than 300V for the connection between indoor and outdoor unit.
(For example, Type SJO-WA)

Outdoor unit

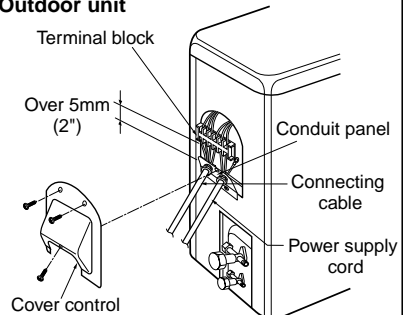

2

Connection method of the connecting cable (Example)

- (1) Dismount two-caps on the conduit panel.
- (2) Make a hole appropriate for the passage of connection cable through on cap by tool.
(for low voltage line)
- (3) Pass the connecting cable through the hole.
- (4) Properly connect the cable on the terminal block.
- (5) Fix the connection cable with clamp cord provided on the unit not to have strain at the terminal when the connection cable is pulled outside up to a 35 pound weight.
- (6) Wind the vinyl tape round the connecting cable for sealing between the surface of the connection cable and cap.
- (7) Mount the taped part of cable on the cap.
- (8) Finally, mount the holed cap with the wound cable on the conduit panel.

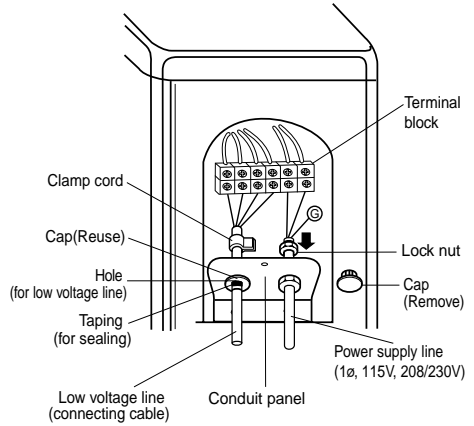

WARNING

Loose wiring may cause the terminal to overheat or result in unit malfunction. A fire hazard may also exist. Therefore, be sure all wiring is tightly connected.

When connecting each power wire to the corresponding terminal, follow instructions "How to connect wiring to the terminals" and fasten the wire tightly with the fixing screw of the terminal plate.

How to connect wiring to the terminals

■ For solid core wiring (or F-cable)

- (1) Cut the wire end with a wire cutter or wire-cutting pliers, then strip the insulation to expose the solid wire about 25mm(15/16")
- (2) Using a screwdriver, remove the terminal screw(s) on the terminal plate.
- (3) Using pliers, bend the solid wire to form a loop suitable for the terminal screw.
- (4) Shape the loop wire properly, place it on the terminal plate and tighten securely with the terminal screw using a screwdriver.

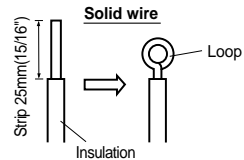

■ For strand wiring

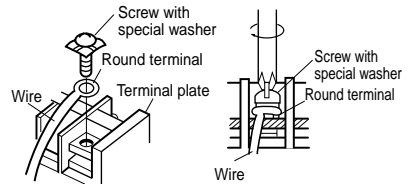
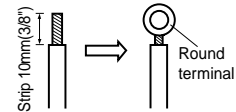

■ For strand wiring

- (1) Cut the wire end with a wire cutter or wire-cutting pliers, then strip the insulation to expose the strand wiring about 10mm(3/8").
- (2) Using a screwdriver, remove the terminal screw(s) on the terminal plate.
- (3) Using a round terminal fastener or pliers, securely clamp each stripped wire end with a round terminal.
- (4) Position the round terminal wire, and replace and tighten the terminal screw using a screwdriver.

CAUTION

If a power plug is not to be used, provide a circuit breaker between power source and the unit as shown below.

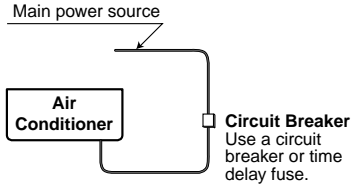

3 *Connect the cable to the indoor unit*

1. Connect the wires to the terminals on the control board individually according to the outdoor unit connection.

- Ensure that the color of the wires of outdoor unit and the terminal No. are the same as those of indoor unit respectively.
(Refer to Wiring diagram on page 11.)

WARNING

- Be sure to refer to the wiring diagram label inside the cover control and carry out the correct field wiring. Wrong wiring can cause the unit to misoperate to result in a fire hazard.
- Check local electrical codes and any specified wiring instructions or limitations.

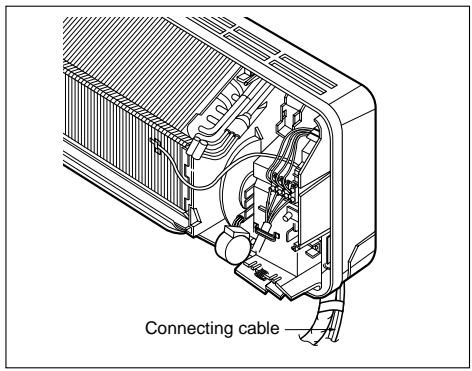

2. Attach the Grille onto the cabinet.

- Grasp lower the left and right side of the Grille and engage four tabs on the top inside edge of the chassis.
- Press the Grille toward the chassis until it will be back into place.

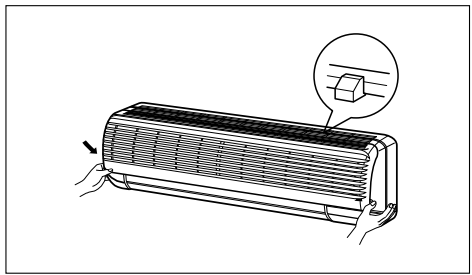

CHECKING THE DRAINAGE AND FORMING THE PIPINGS

1

Checking the drainage

A To remove the front panel from the indoor unit.

- Set the air direction louvers up-and-down to the position(horizontally) by hand.
- Remove the securing screws that retain the front panel. Pull the lower left and right sides of the grille toward you and lift it off.

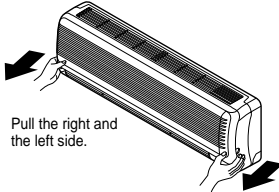

Pull the right and the left side.

B To check the drainage.

- Pour a glass of water on the evaporator.
- Ensure the water flows through the drain hose of the indoor unit without any leakage and goes out the drain exit.

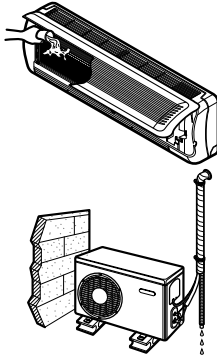

C Drain piping

- The drain hose should point downward for easy drain flow.

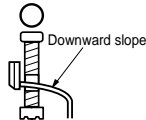

- Do not make drain piping.

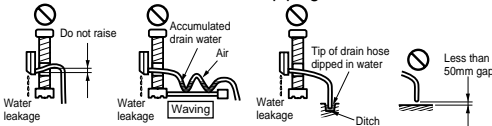

2

Form the piping

A Form the piping by wrapping the connecting portion of the indoor unit with insulation material and secure it with two kinds of vinyl tapes.

- If you want to connect an additional drain hose, the end of the drain outlet should be routed above the ground. Secure the drain hose appropriately.

B In cases where the outdoor unit is installed below the indoor unit perform the following.

- Tape the piping, drain hose and connecting cable from down to up.
- Secure the tapped piping along the exterior wall using saddle or equivalent.

Seal small openings around pipings with a gum type sealer.

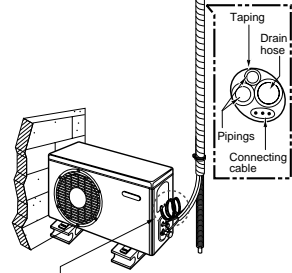

Trap is required to prevent water from entering into electrical parts.

C In cases where the Outdoor unit is installed above the Indoor unit perform the following.

- Tape the piping and connecting cable from down to up.
- Secure the taped piping along the exterior wall. Form a trap to prevent water entering the room.
- Fix the piping onto the wall by saddle or equivalent.

Seal a small opening around the pipings with gum type sealer.

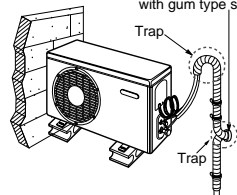

1

Air purging

Air and moisture remaining in the refrigerant system have undesirable effects as indicated below.

- Pressure in the system rises.
- Operating current rises.
- Cooling(or heating) efficiency drops.
- Moisture in the refrigerant circuit may freeze and block capillary tubing.
- Water may lead to corrosion of parts in the refrigeration system.

Therefore, the indoor unit and tubing between the indoor and outdoor unit must be leak tested and evacuated to remove any noncondensables and moisture from the system.

- Do a leak test of all joints of the tubing(both indoor and outdoor) and both gas and liquid side service valves. Bubbles indicate a leak. Be sure to wipe off the soap with a clean cloth.
- After the system is found to be free of leaks, relieve the nitrogen pressure by loosening the charge hose connector at the nitrogen cylinder. When the system pressure is reduced to normal, disconnect the hose from the cylinder.

2

Air purging with vacuum pump

A Preparation

- Check that each tube(both liquid and gas side tubes) between the indoor and outdoor units have been properly connected and all wiring for the test run has been completed. Remove the service valve caps from both the gas and the liquid side on the outdoor unit. Note that both the liquid and the gas side service valves on the outdoor unit are kept closed at this stage.

B Leak test

- Connect the manifold valve(with pressure gauges) and dry nitrogen gas cylinder to this service port with charge hoses.

CAUTION

Be sure to use a manifold valve for air purging. If it is not available, use a stop valve for this purpose. The "Hi" knob of the manifold valve must always be kept close.

- Pressurize the system to no more than 150 P.S.I.G. with dry nitrogen gas and close the cylinder valve when the gauge reading reached 150 P.S.I.G. Next, test for leaks with liquid soap.

CAUTION

To avoid nitrogen entering the refrigerant system in a liquid state, the top of the cylinder must be higher than its bottom when you pressurize the system. Usually, the cylinder is used in a vertical standing position.

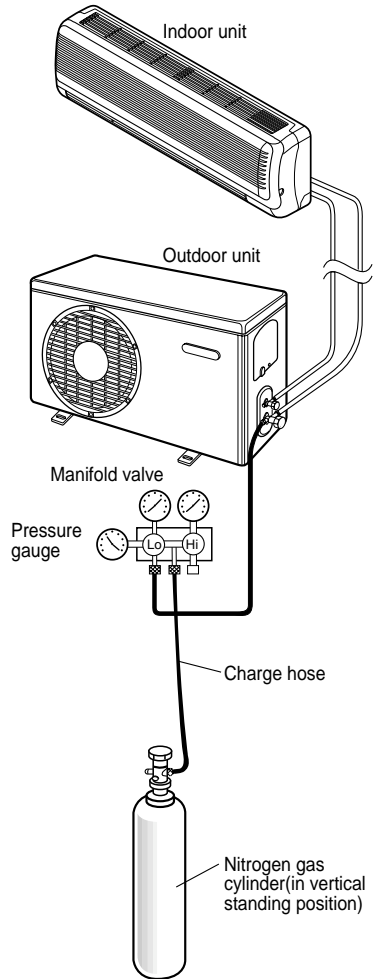

C Evacuation

- Connect the charge hose end described in the preceding steps to the vacuum pump to evacuate the tubing and indoor unit. Confirm the "Lo" knob of the manifold valve is open. Then, run the vacuum pump. The operation time for evacuation varies with tubing length and capacity of the pump. The following table shows the time required for evacuation.

Required time for evacuation when 30 gal/h vacuum pump is used	
If tubing length is less than 10m (33 ft)	if tubing length is longer than 10m (33 ft)
10 min. or more	15 min. or more

- When the desired vacuum is reached, close the "Lo" knob of the manifold valve and stop the vacuum pump.

D Finishing the job

- With a service valve wrench, turn the valve stem of liquid side valve counter-clockwise to fully open the valve.
- Turn the valve stem of gas side valve counter-clockwise to fully open the valve.
- Loosen the charge hose connected to the gas side service port slightly to release the pressure, then remove the hose.
- Replace the flare nut and its bonnet on the gas side service port and fasten the flare nut securely with an adjustable wrench. This process is very important to prevent leakage from the system.
- Replace the valve caps at both gas and liquid side service valves and fasten them tight.

This completes air purging with a vacuum pump. The air conditioner is now ready to test run.

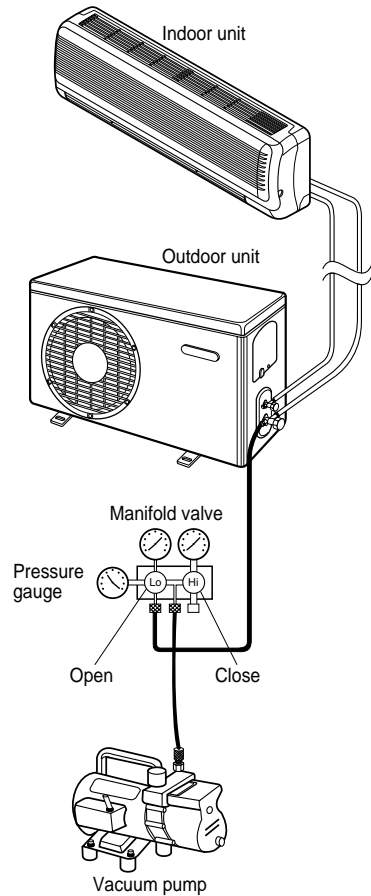

TEST RUNNING

1. Check that all tubing and wiring have been properly connected.
2. Check that the gas and liquid side service valves are fully open.

A Prepare remote control

- 1 Remove the battery cover by pulling it according to the arrow direction.
- 2 Insert new batteries making sure that the (+) and (-) of battery are installed correctly.
- 3 Reattach the cover by pushing it back into position.

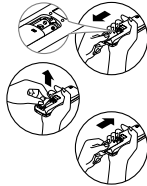

NOTE:

- Use 2 AAA(1.5volt) batteries. Do not use rechargeable batteries.
- Remove the batteries from the remote control if the system is not going to be used for a long time.

B Settlement of outdoor unit

- Anchor the outdoor unit with a bolt and nut(ø10mm) tightly and horizontally on a concrete or rigid mount.
- When installing on the wall, roof or rooftop, anchor the mounting base securely with a nail or wire assuming the influence of wind and earthquake.
- In the case when the vibration of the unit is conveyed to the hose, secure the unit with an anti-vibration bushing.

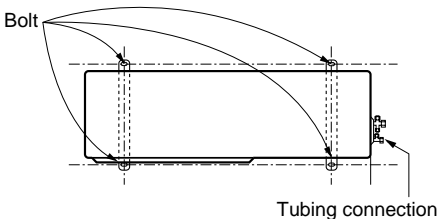

C Evaluation of the performance

Operate unit for 15~20 minutes, then check the system refrigerant charge:

1. Measure the pressure of the gas side service valve.
2. Measure the temperature of the intake and discharge of air.

3. Ensure the difference between the intake temperature and the discharge is more than 8°C(46°F) (Cooling) or (Heating).

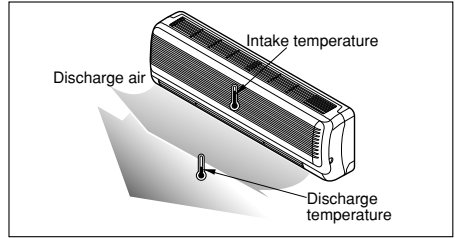

4. For reference; the gas side pressure of optimum condition is as below.(Cooling)

Outside ambient TEMP.	The pressure of the gas side service valve.
35°C (95°F)	4~5kg/cm ² G(56.8~71.0 P.S.I.G.)

NOTE: If the actual pressure is higher than shown, the system is most likely over-charged, and charge should be removed. If the actual pressure are lower than shown, the system is most likely undercharged, and charge should be added. The air conditioner is now ready for use.

PUMP DOWN

This is performed when the unit is to be relocated or the refrigerant circuit is serviced. Pump Down means collecting all refrigerant in the outdoor unit without loss in refrigerant gas.

CAUTION:

Be sure to perform Pump Down procedure with the unit cooling mode.

Pump Down Procedure

1. Connect a low-pressure gauge manifold hose to the charge port on the gas side service valve.
2. Open the gas side service valve halfway and purge the air from the manifold hose using the refrigerant gas.
3. Close the liquid side service valve(all the way in).
4. Turn on the unit's operating switch and start the cooling operation.
5. When the low-pressure gauge reading becomes 1 to 0.5kg/cm² G(14.2 to 7.1 P.S.I.G.), fully close the gas side valve stem and then quickly turn off the unit. At that time, Pump Down has been completed and all refrigerant gas will have been collected in the outdoor unit.

MEMO
