

This Owner's Manual is provided and hosted by [Appliance Factory Parts](#).



LG PQCPB11A0E Owner's Manual

[Shop genuine replacement parts for LG PQCPB11A0E](#)



[Find Your LG Air Conditioner Parts - Select From 2328 Models](#)

----- Manual continues below -----



website <http://www.lgservice.com>

LG

ACP

Advanced Control Platform

(PQCPA11A0E, PQCPB11A0E)

Installation/Owner's Manual

Caution

- Read this manual thoroughly before installing the product.
- Only the certified professional should install this product.
- Keep this manual for referring during the operation later.

Contents

1. ACP FUNCTIONS & SPECIFICATION1-1

Functions of ACP	1-1
Denomination of ACP	1-4
Components of ACP	1-6
Hardware specification of ACP	1-7

2. INSTALLING ACP2-1

Before installing the ACP	2-2
• Using the single ACP as web server	2-3
• Connecting the single ACP to the AC Manager	2-5
• Connecting more than on ACPs to the AC Manager	2-7
Setting the indoor unit address	2-8
• Setting the address by the wired remote controller	2-9
• Setting the address by the wireless remote controller.....	2-10
Setting the PI485 and Connecting the cable	2-12
• Setting the PI485 DIP switch	2-12
• Connecting the 2PIN connector	2-14
• Connecting RS485 cable to PI485.....	2-16
Installing the ACP and Connecting the cable.....	2-19
• Fixing the ACP at the installation site	2-19
• Connecting RS485 cable to ACP	2-20
• Connecting Ethernet cable to ACP	2-23
• Connecting Power adaptor to ACP.....	2-24
Configuring the ACP network.....	2-25
• Before configuring the ACP environment.....	2-25
• Setting the IP address.....	2-29
• Setting the gateway address.....	2-30
• Setting the net mask address	2-31
• Checking the network environment	2-32

Setting the functions of the ACP	2-33
• Before setting the functions of the ACP	2-33
• Selecting Peak or Demand	2-34
• Selecting the ACCS display language.....	2-36
• Setting whether to use the schedule function or not	2-38
• Setting whether to use the wattage display function or not	2-40
• Setting error history display	2-42
Configuring the ACCS access	2-43
• Chceking the MS JAVA VM installation	2-43
• Checking the MS Explorer security setting	2-45
Entering the indoor unit & ventilator information.....	2-49
• If the ACP is connected to the AC Manager	2-49
• If the ACP is not connected to the AC Manager.....	2-50
Making sure and checking the ACP installation	2-67

3. ACP OPERATION BY USING THE LG ACCS3-1

Accessing the ACCS.....	3-1
Reviewing the initial ACCS screen.....	3-4
Controlling the air conditioner.....	3-7
Controlling the ventilator	3-14
Setting the schedule	3-21
• Reviewing the schedule setup screen	3-21
• Example for setting the schedule	3-32
Controlling the peak operation rate	3-44
Controlling the demand electric power.....	3-51
Monitoring the air conditioner status.....	3-56
Reviewing the error history.....	3-58
Reviewing the power consumption (interconnecting with the power display).....	3-61
Setting the system	3-66

4. REFERENCE4-1

Troubleshooting.....	4-1
Guide for the open source software.....	4-2
UTP cable connection chart.....	4-3

Note for safety

In order to prevent the user's injury or the damage of the product, keep the followings to use the product.

- The service center or the professional installation agency certified by our company should perform the installation because the professional technique is required to install.
- The installer should be responsible for all problems related the installation occurred by the installation work without the installation certification, for which our company does not offer the free-of-charge service.
- Using the product ignoring the note for safety may cause the misoperation of the product, which may cause the body's injury or the damage of the product. The note for safety is classified into two following items:

 **WARNING** For causing the critical injury to the body.

 **CAUTION** For the body's injury or the damage of the product.

- The symbols used at this manual have the following meanings:



It should not be followed.



It should be carefully kept to perform.

! WARNING

■ When installing

Any question about the product should be asked to the service center or the professional installation agency.

- The non-professional may cause accident, electric shock, explosion or injury.

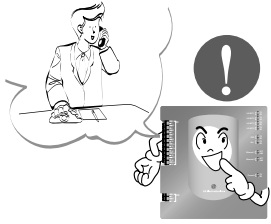

Consult the service center or the professional installation agency about reinstalling the installed product.

- The non-professional may cause accident, electric shock, explosion or injury.

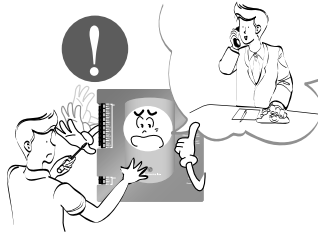

The standardized part.

- The non-standard part may cause electric shock, explosion, injury or failure.

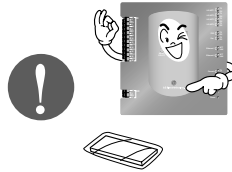

Consult the service center or the professional installation agency about reinstalling the installed product

- The non-professional may cause electric shock, explosion or injury.

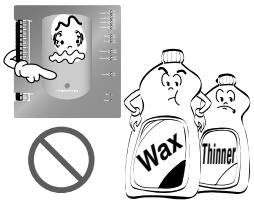

The flammable gas or the combustible substance such as gasoline, benzene and thinner should not be used near the power cord.

- It may cause explosion or fire.



Do not disassemble, repair or modify the product at random.

- It may cause electric shock or fire.



Do not install the product at the wet place.

- It may cause to degrade the insulating ability and may cause fire.



■ When using

Do not change or extend the power cord.

- It may cause fire or electric shock.



Do not place any heating device near the product.

- It may cause fire.

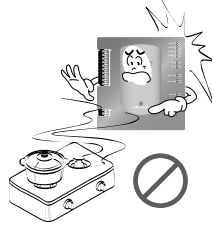

Do not use any heating device near the power cord.

- It may cause fire or electric shock.

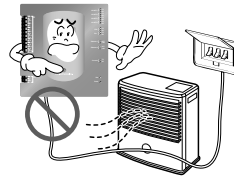

Do not let water flow into the product.

- It may cause electric shock and failure.



Do not put heavy weight on the power cord.

- It may cause fire or electric shock.

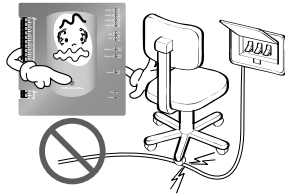

Do not put heavy weight on the product.

- It may cause the failure of the product.

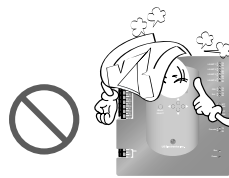

If the product is flooded, consult the service centre or the professional installation agency.

- It may cause fire or electric shock.



Let the children or the old and the weak be controlled by the guardian to use.

- It may cause accident or failure.

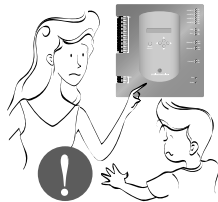

Do not give any shock to the product.

- Any shock to the product may cause failure.

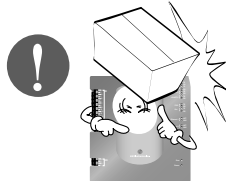

⚠ CAUTION

■ When using

Do not use strong detergent such as solvent, but a soft cloth.

- It may cause fire or to deform the product.

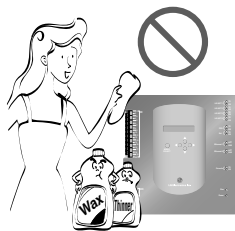

Grab the head of the plug of the power cord to pull when disconnecting the plug, and do not touch the plug with wet hands.

- It may cause fire or electric shock.

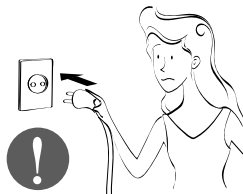

1. ACP Functions & Specification

The ACP(Advanced Control Platform) is the central controller which can control up to 256 indoor units of the airconditioner at one place individually or totally. The ACP can monitor or control to operate the airconditioner and the ventilator installed at each room of the building from the place such as the control room of a building, the administrative room of a school.

Functions of ACP

Main functions of the ACP are as follows:

Using the external button of the ACP to set the environment

The following functions can be set by using the external buttons of the ACP.

- Set the network environment (IP address, net mask, gateway)
- Set one of Peak/Demand function to use
- Set the language displayed on the LG ACCS screen
- Set whether to use the schedule feature or not
- Set whether to use the wathour meter feature or not.

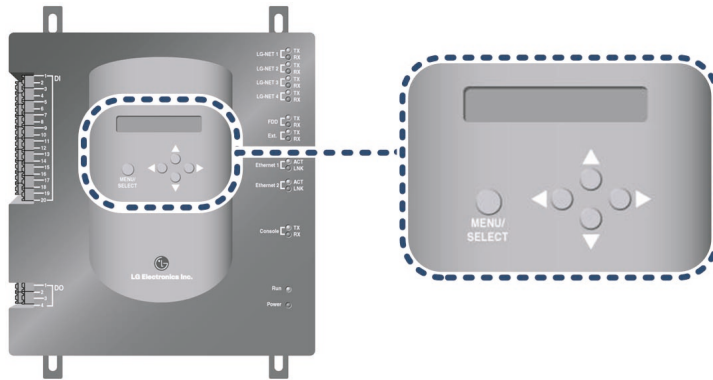

Built-in Web server

Various functions of contents can be used when the IP address of the ACP is entered at the address window by using the Internet Explorer without installing a separate PC program to automatically execute the central control program at the ACP web server.

Also, the demand control feature to control the demand power is controlled by directly connecting the ACP to the demand controller without installing a separate PC program.

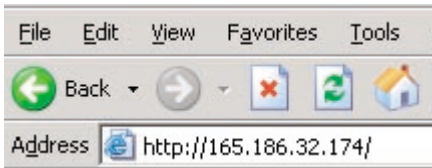
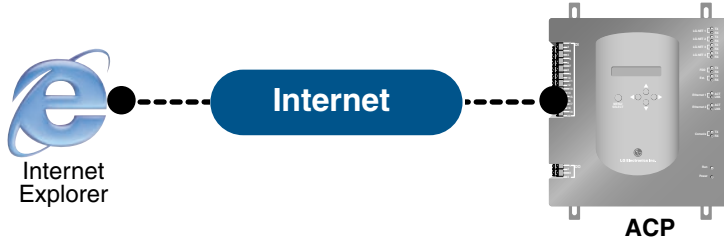

- ▷ Control 256 indoor units of the airconditioner at maximum
- ▷ Monitoring the error and operation state
- ▷ Controlling the peak/demand electric power
- ▷ Setting the system

Interconnecting with the AC Manager

Various features offered by the AC Manager are offered by connecting the AC Manager program installed at the PC to the ACP. Especially, when using the schedule feature of the AC Manager, because the ACP has its own engine, even though the user turns off the PC where the AC Manager is installed, the ACP can perform the schedule feature by itself.

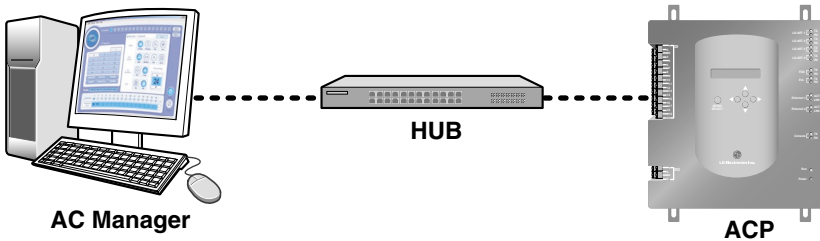

Interconnecting with the simple central controller

The 16-room simple central controller can be interconnected with the ACP. When the ACP centrally controlling all airconditioners and the simple central controller at each floor of the building are used together, the airconditioner can be controlled more easily.

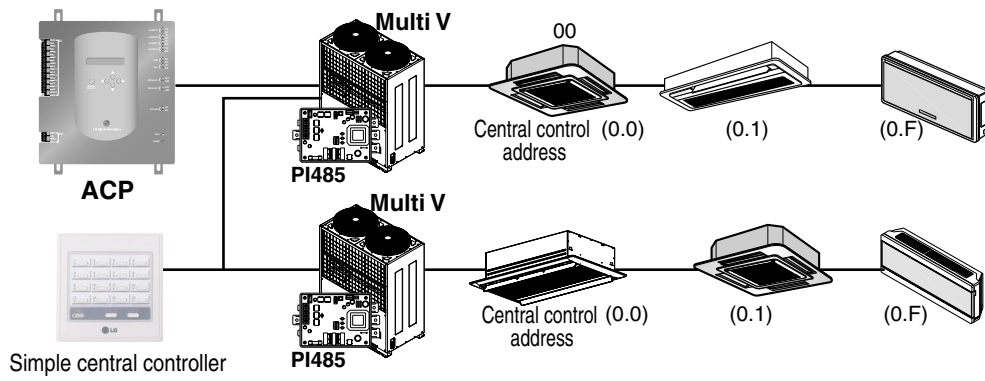

Denomination of ACP

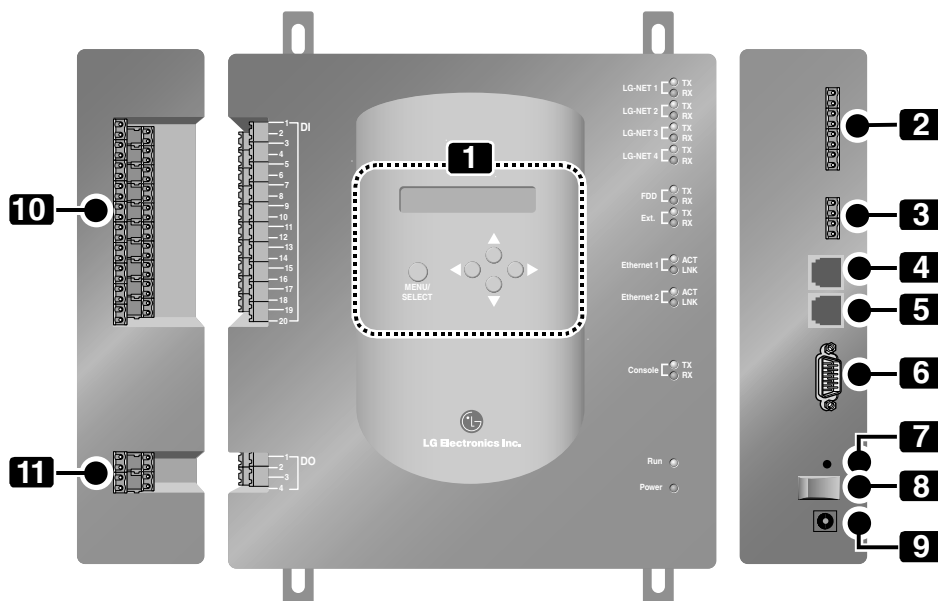

1 Buttons and LCD

Buttons and the LCD to display the network environment setting and other information

2 RS485 communication port (for PI485 connection)

RS485 communication port connecting to the PI485 to connect the airconditioner and the ventilator (4EA in total)

3 RS485 communication port (for external extension)

RS485 communication port spar for exter extension (2EA in total)

4 Ethernet port (for connecting the Internet and the AC Manager)

The Ethernet port for connecting the Internet and the AC Manager

5 Ethernet port (spare)

Ethernet port spare for the function extension of the ACP

6 RS232 port

RS232 port for updating the software of the ACP

7 Reset switch

Switch for resetting the ACP by the software

8 Power switch

Switch for turning on/off the ACP

9 Adaptor connection port

Port for DC 12V to connect the adaptor supplying the power

10 External input signal terminal

Port for connecting the external input signal (20EA in total). Input terminal not requiring the power.

11 External output signal terminal

Connection port spare for the function extension of the ACP (4EA in total)

Note: External input/output signal terminal

9 external input signal terminal and 10 external output signal terminal are configured at the PQCPB11A0E only. These terminals are used to connect the AC Manager to set the fire control function. These terminal are used to set the indoor unit to operate or stop for responding High or Low signal of each external input signal.

In case of PQCPA11A0E model, a separate IO Kit (Model: PQCPE11A0E) can be purchased and installed to use for connecting the external signal.

Components of ACP

The following components are contained within the packaging box of the ACP. Open the packaging box of the ACP to make sure that all components are contained.

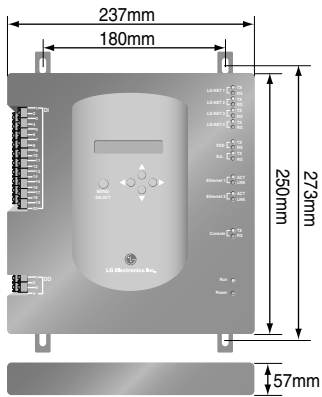

ACP
(Advanced Control Platform)

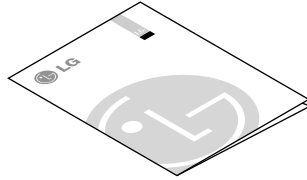

ACP
Installation/Owner's Manual

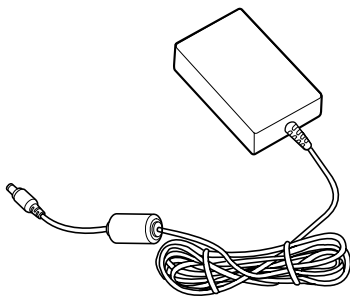

Adaptor for Power supply

Input: 100~240V
AC 50/60Hz 1.5A
Output: DC 12V
3.33A, 40W MAX

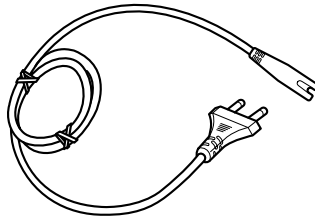

Power Cord

International Standard
IEC320 C14 Type

Caution: Using the standardized part



We are not responsible for any problem caused by using the adaptor other than the standardized one offered by us, so using any non-standard part should be prohibited. You can consult the LG System Air Conditioner Support Division about the applicable product.

Notice : In Australia, purchase the power code

In Australia, the power code from local area.
The power code is not included in the package

Hardware Specification of ACP

Item	Description
CPU	PXA255-400MHz Xscale
RAM	128MB (32x4) SDRAM
ROM	<ul style="list-style-type: none"> • 512KB NOR Flash – Boot image • 128MB (64x2) NAND Flash – Program image, Database, others
RS-232 Console	For updating the program (for developing)
Communication port	<ul style="list-style-type: none"> • RS485 port: PI485 communication port 4EA, External device connection port 2EA • RS-232 communication port: Port for updating the program 1EA • Ethernet port: for Internet connection 1EA (10Base-T) Spare 1EA <p>For the PQCPB11A0E model, the following ports are supplied as default.</p> <ul style="list-style-type: none"> • External input port: 20EA (Pulse contable, DC 12V) • External output port: 4EA (Relay output, 5V) <p>For the PQCPA11A0E model, the IO Kit (PQCPE11A0E) should be separately purchased for connecting the above port</p>
LED	20EA (for displaying RS communication status, Ethernet communication status, RS232 communication status, Power operation status)
LCD	16x2 Character, displaying Network environment setting and information

Note: License policy

This product follows the GPL(General Public License) for using the embedded Linux.

2. Installing ACP

This chapter describes how to install the ACP to use.

Caution: Installing the ACP



The ACP installation work needs the professional technique. Therefore, **the installation described at this chapter should be performed by the certified installation professional.**

Consult the service center or the professional installation agency certified by us about any question or request related to the installation.

In order to use the ACP, the environment for the ACP, the indoor unit and the ventilator to communicate should be built and the indoor unit should be registered.

In order to use the ACP, the installation should be performed by the following order.

STEP 1. Check the environment before installing the ACP

Before installing the ACP, check the network configuration according to the interconnection between the ACP and the external device.

STEP 2. Set the indoor unit address and Connecting the PI485

Set the address of the ACP not overlapped with the connecting indoor unit and connect the PI485.

STEP 3. Install the ACP and set the environment and the function

Install the ACP and set the network environment and the function.

STEP 4. ACCS access and Information input

Set the access environment at the LG ACCS, the ACP operation program and enter the air conditioner information.

STEP 5. Make sure and check the ACP installation

Make sure and check that the ACP is normally installed.

Before installing the ACP

ACP provides 4 RS485 ports to connect the indoor unit. Maximum of 16 units can be connected to PI485 for outdoor unit in 1 RS385 port, and maximum of 31 units for SINGLE/Ventilator PI485.

256 indoor units at maximum can be connected to one ACP. All of 256 indoor units may be connected to one RS485 port, which is the maximum number of units for the ACP to connect. But, in order to improve the communication performance of the RS485, we recommend to distribute them to four ports.

Note: Change the number of connections of RS485

If it is inevitable to change the above specification, call the system air conditioner support division

By considering three following cases using the ACP, perform the installation after carefully considering how to use.

- Install the single ACP to use as web server
- Connect the single ACP to the AC Manager to use
- Connect more than one ACP to the AC Manager via the hub to use

Using the single ACP as web server

When one ACP is used as web server, the ACP should be connected with the network structure as shown at the following examples.

Using the hub

If it is connected via the hub, the network can be configured as shown at the following example.

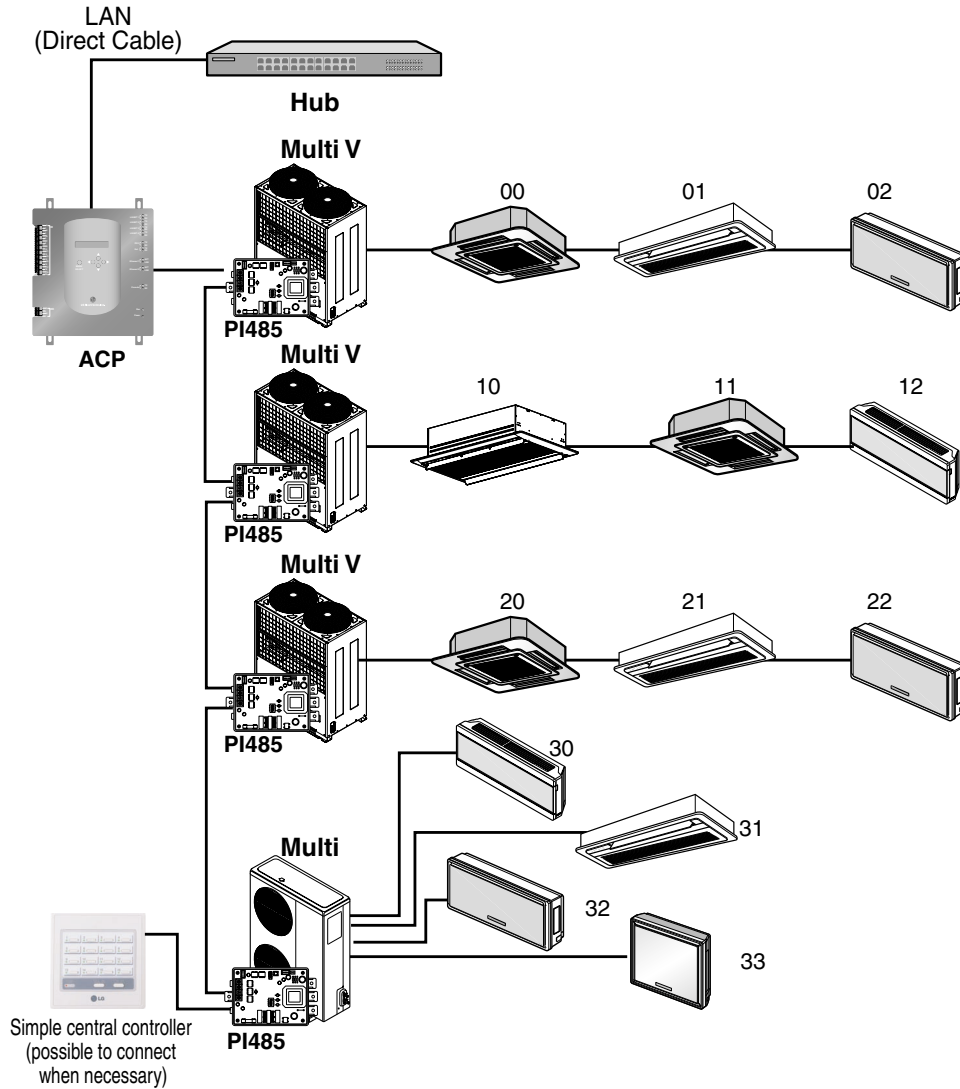

Not using the hub

If it is connected without the hub, the network can be configured as shown at the following example.

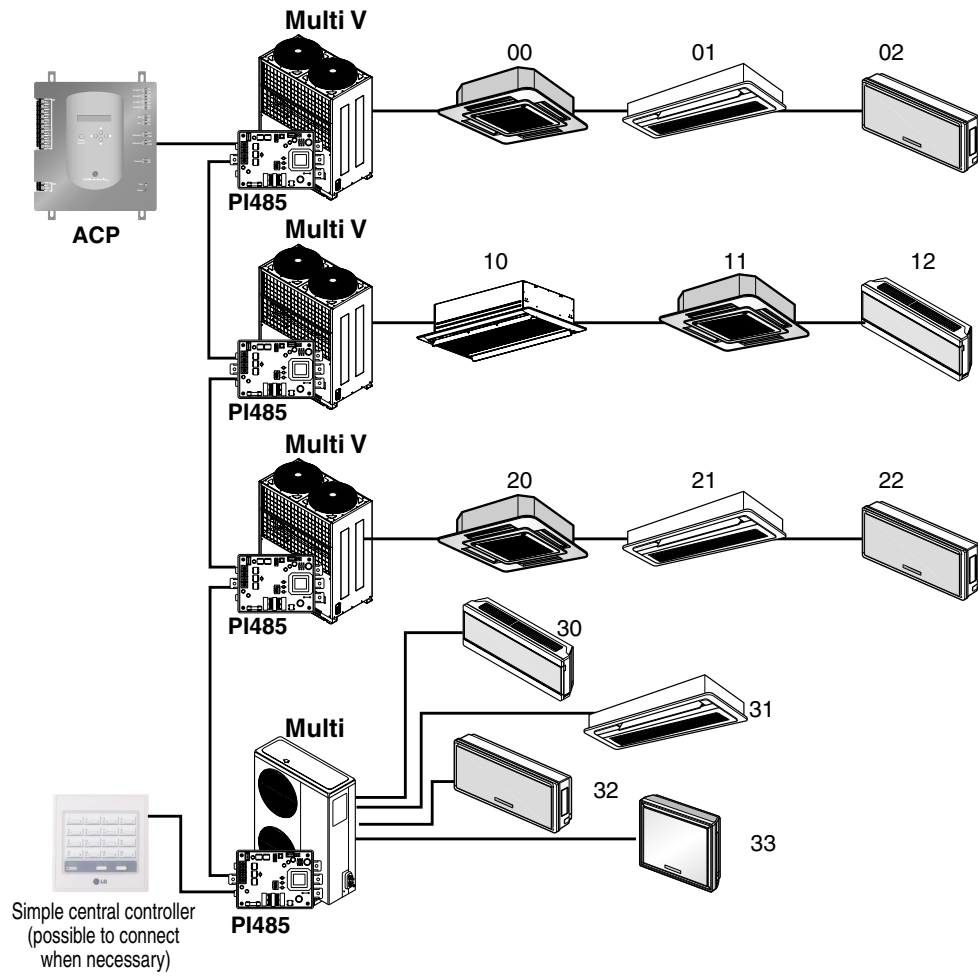

Connecting the single ACP to the AC Manager

When one ACP is connected to the AC Manager without the hub, the ACP should be connected with the network structure as shown at the following examples.

Using the hub

If it is connected via the hub, the network can be configured as shown at the following example.

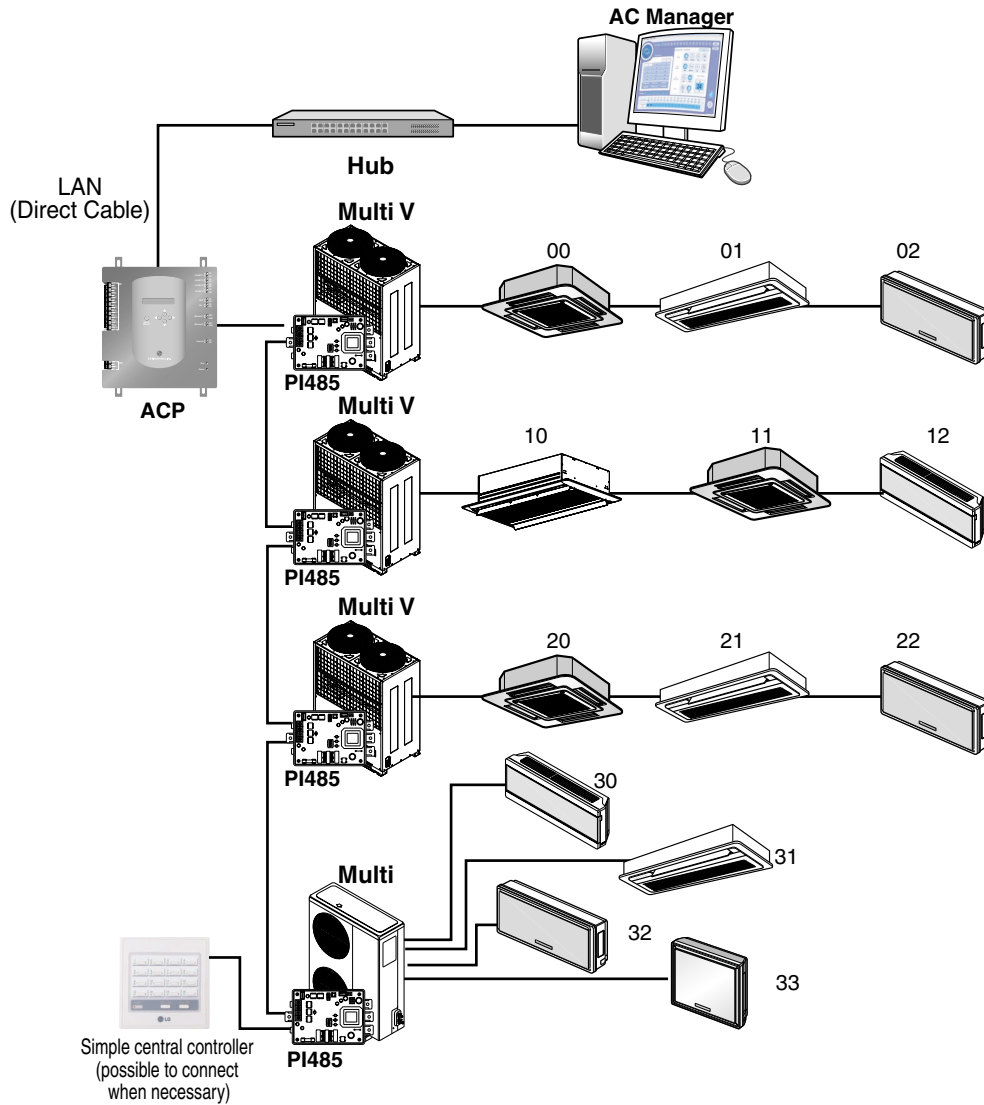

Not using the hub

If it is connected without the hub, the network can be configured as shown at the following example.

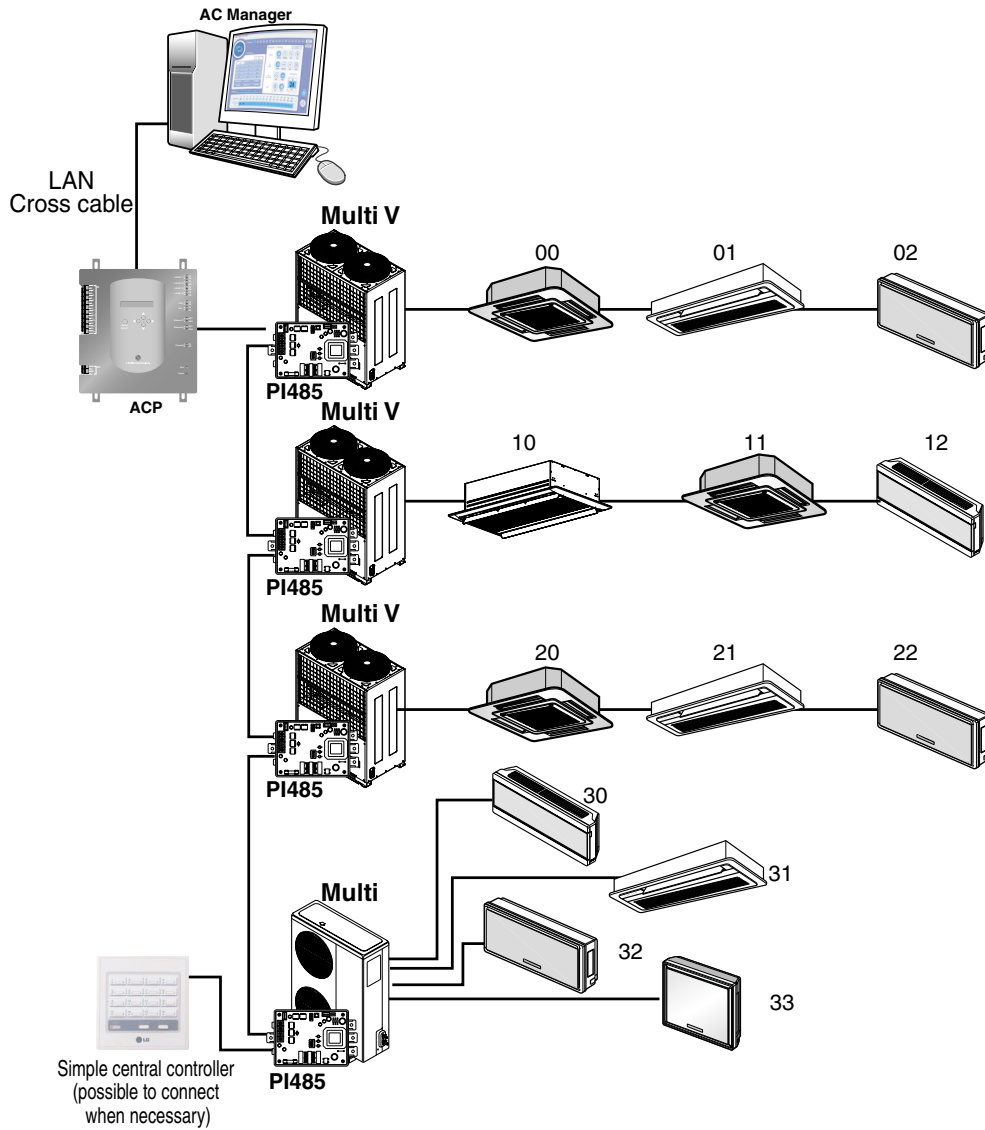

Connecting more than one ACPs to the AC Manager

When more than one ACP are connected to the AC Manager via the hub, the ACP should be connected with the network structure as shown at the following examples.

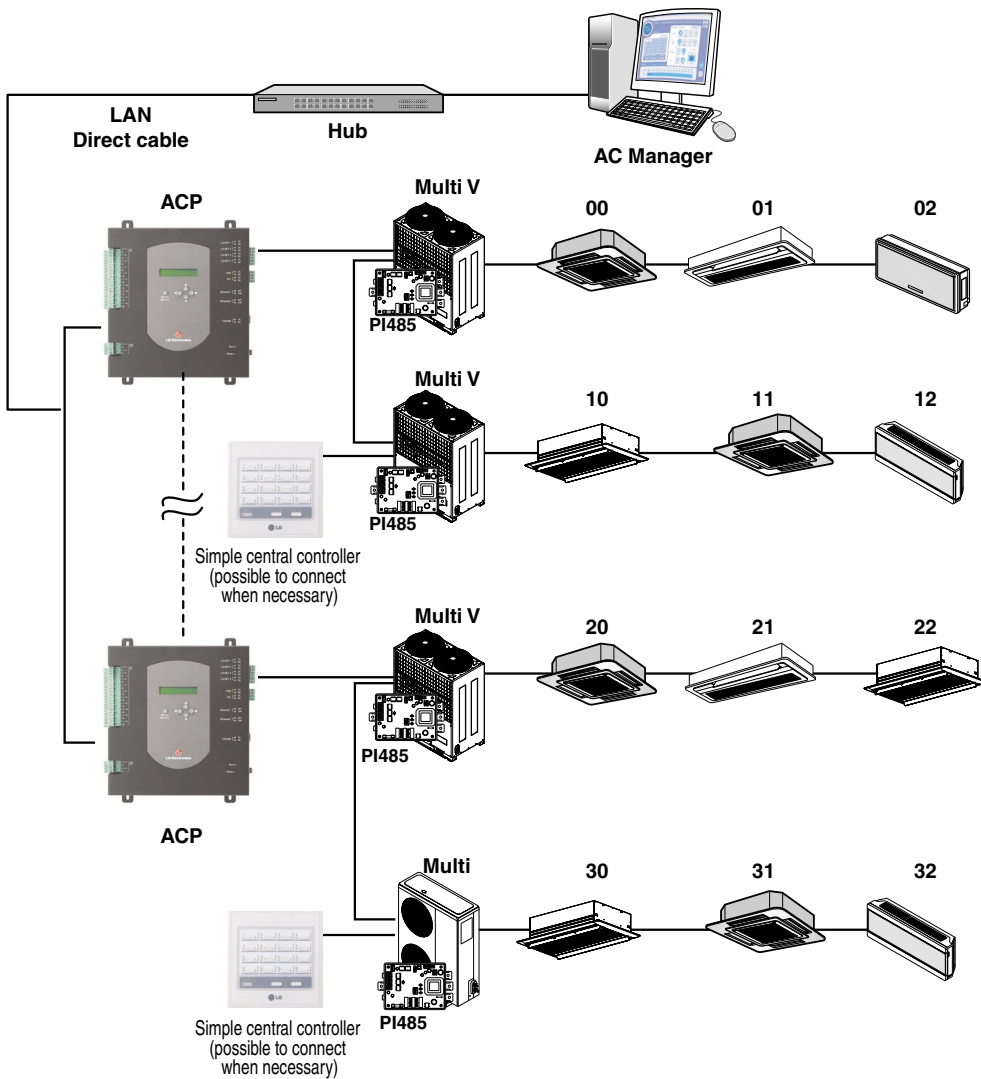

Setting the indoor unit address

By considering the entire installation configuration connecting to one ACP, set the address to each indoor unit not to be overlapped. 00~FF in hexadecimal can be set to the indoor unit address.

The following example sets the address to the indoor unit.

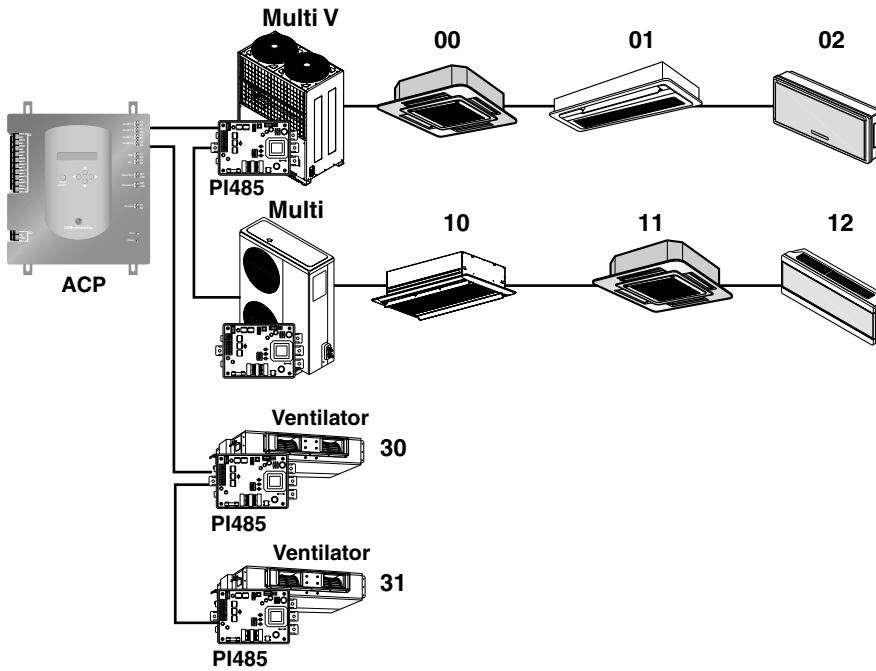

When the ACP is interconnected with the AC Manager, the ventilator can be together installed and controlled. The above figure shows the example that sets 30 and 31 to the ventilators as address and connects to the ACP.

Caution: Connecting the ventilator to the RS485



The ventilator and the air conditioner can not be connected together to the same RS485 communication cable. When connecting the ventilator to the RS485 communication cable, the cable other than the RS485 communication cable connecting the air conditioner should be used.

The next section describes how to set the address to each indoor unit by using the wired or wireless remote controller according to the given number.

Setting address with wired remote controller

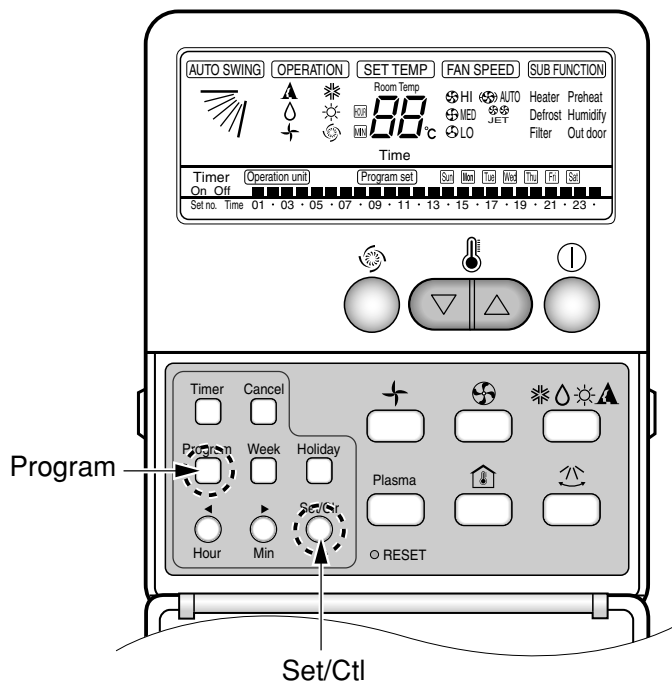

1. Press Week Program & Set/Ctl keys at the same time.
2. Set the indoor unit address using the temperature controller.
Allowed Range : 00-FF

EX) 3 A

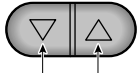

Group No. Indoor Unit No.

3. Complete the address setting to press the week Program & Set/Ctl keys at the same time for 3 seconds.

※ Some remote controllers may not be supported by above functions, according to the production date of wired/wireless remote controllers. As it has no concern with customers' use, use the remote controller available for the address setting during installation.

Setting address with wireless remote controller

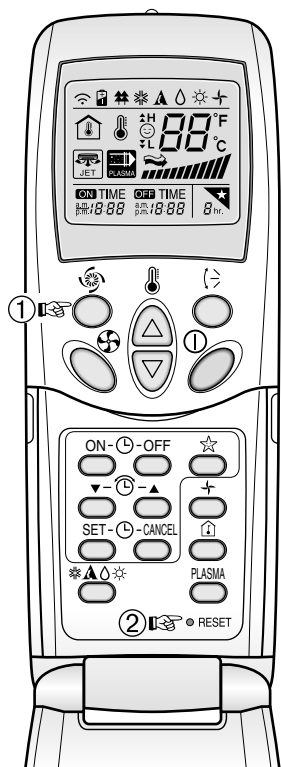

You can set the address of the indoor unit through the wireless remote controller that controls the indoor unit. To set the address of the indoor unit with the wireless remote controller, proceed as follows.

1. With the [Power Cool] button pressed, press the [RESET] button. The [Power Cool] button must be pressed for more than 3 seconds.
2. Use the [Temperature Adjustment] button to set the address of the indoor unit.

Temperature adjustment

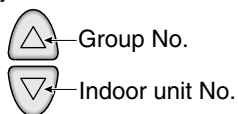

3. After setting the address, press the [Operate/Stop] button once toward the indoor unit.
4. When the set address is displayed on the indoor unit, the address setting is complete.

Reference: Address display time and method

The address display time and method may differ by the type of the indoor unit.

5. When you reset the remote controller, it switches from the address setting mode to general operation mode.

Reference: Type of remote controller

When using a different type of remote controller from the one described above, refer to the user manual of the applicable remote controller.

Information: Checking the set address

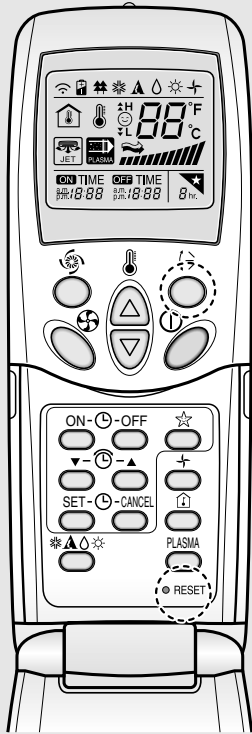

You can check the set address by using the wireless remote controller. To check the set address, proceed as follows.

1. With the [Wind Up/Down] button pressed, press the [RESET] button. The [Wind Up/Down] button must be pressed for more than 3 seconds.
2. Press the [Operate/Stop] button once toward the indoor unit. The set address will be shown on the display part of the indoor unit. The address display time and method can differ by the type of indoor unit.
3. Reset the remote controller again to use it in general operation mode.

Setting the PI485 and Connecting the cable

After setting the address of the indoor unit, install the PI485 and set the DIP switch. And then, connect the RS485 cable for communicating with the ACP.

Note: Installing the PI485

Installing the PI485 depends on the outdoor unit. So, install the PI485 by referring to the PI485 manual or the installation technique information.

Setting the PI485 DIP switch

After installing the PI485 suitable to the product, the DIP switch should be set. The DIP switch of the PI485 can be checked at the following place.

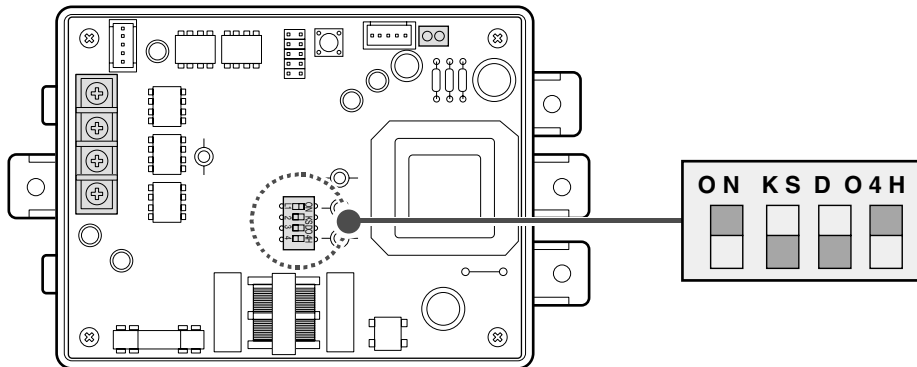

Dip switch	Setting	Product type
	1, 4 ON 2, 3 OFF	- Multi V product(CRUN, LRA product excluded) - MPS product with the common PCB applied - MPS inverter product
	2, 4 ON 1, 3 OFF	- MPS product with the common PCB not applied
	1, 2, 3, 4 ON	- Multi V CRUN, LRA product
	3, 4 ON	- Single indoor unit (connected to the PI485 for the indoor unit) - Ventilator (connected to the PI485 for ventilating)

Note: PCB part number

The MPS product with the common PCB applied has the following PCB part number:

- PCB P/NO. : 6871A20910A ~ Z
- PCB P/NO. : 6871A20917A ~ Z
- PCB P/NO. : 6871A20918A ~ Z

Caution: Setting the PI485 DIP switch

If the air conditioner selection switch is incorrectly set, the air conditioner may incorrectly operate.

For more information about installing the PI485, see the PI485(M) manual.

Tip: Checking the PI485 DIP switch setting

It can be checked whether the indoor unit address and the DIP switch of the PI485 are correctly set as follows:

- The LED01G blinks as many as the number of the connected indoor units.
- The LED02G and the LED03G continue to blink alternately. (When the LRA/CRUN is connected, the LED02G may blink more than the LED03G.)

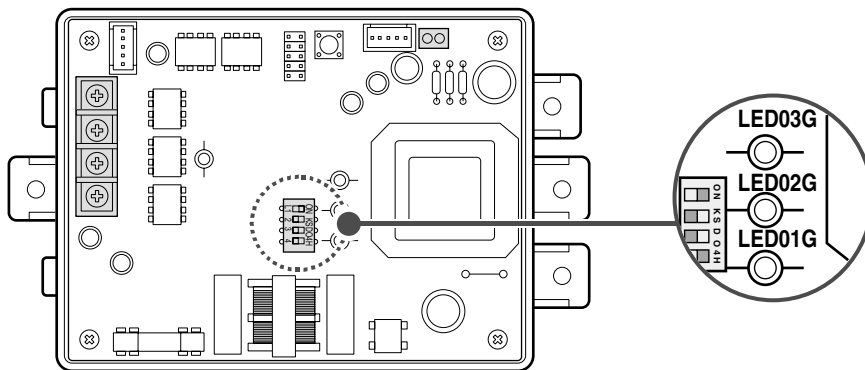

If the LED is abnormally different from the above description, check again the indoor unit address setting and the DIP switch setting.

Connecting the 2PIN connector

If you want to use the individual lock function for setting mode, wind flow, and temperature lock by the central control, the 2PIN connector should be connected to the CN_DRY terminal of the PI485 according to the product type.

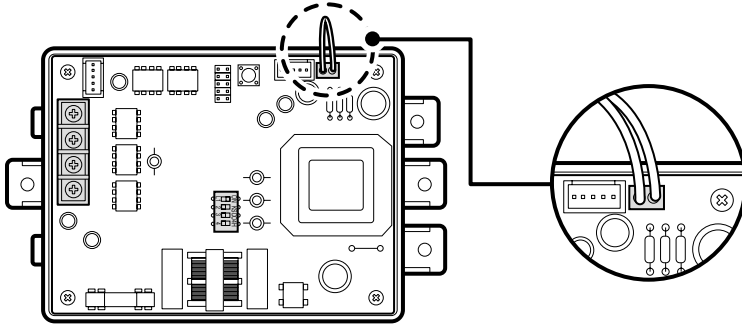

The following figure shows the example of the central control for connecting the 2PIN connector to the CN_DRY terminal.

- 1) 'Heating operation, 20°C , Strong wind, Temperature lock' function is ordered by the central control such as ACP or AC Manager, which is transferred to the remote controller.
- 2) If the user changes the temperature to 25°C by the remote controller, the related command is transferred to the outdoor unit and the remote controller displays the 25°C setting.
- 3) The outdoor unit receives the related command and transfers it to the PI485.
- 4) The PI485 cancels this command and transfers the previous central control command again. And, the remote controller displays again the 20°C temperature transferred by the central control command.

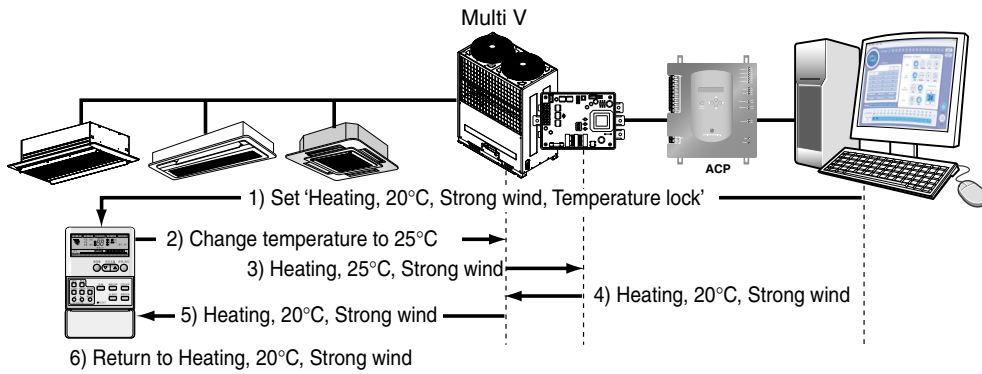

On the other hand, let's see an example of connecting the 2PIN connector to CN_DRY terminal. When a command is given for function of "Heat operation, 20°C setting, high fan level, temperature lock" through the central control, the applicable command is transmitted through the remote controller. "HL (Hard Lock)" message showing the central control status is displayed on the remote controller. If the user sets the temperature to 25°C, the command is blocked at the remote controller.

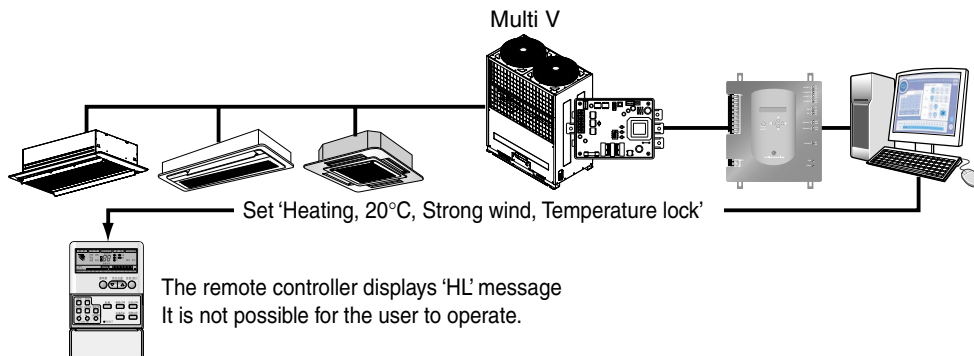

Conncting RS485 cable to PI485

In order to connect the PI485 and the ACP, two RS485 cables should be connected to the BUS_A and the BUS_B of the PI485. Connect the RS485 cables by referring to the following figure.

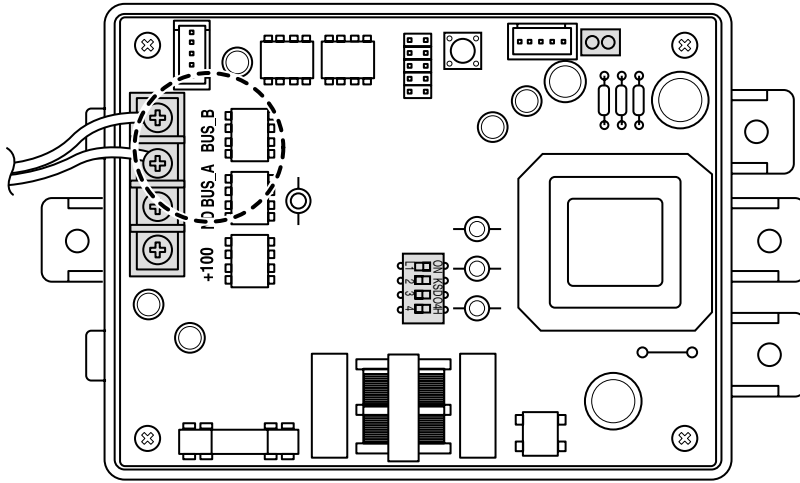

When connecting more than one PI485 to one ACP, connect the BUS_A/BUS_B of the PI485 to the BUS_A/BUS_B of the other PI485 respectively.

The following figure shows the example for connecting more than one PI485 to one ACP.

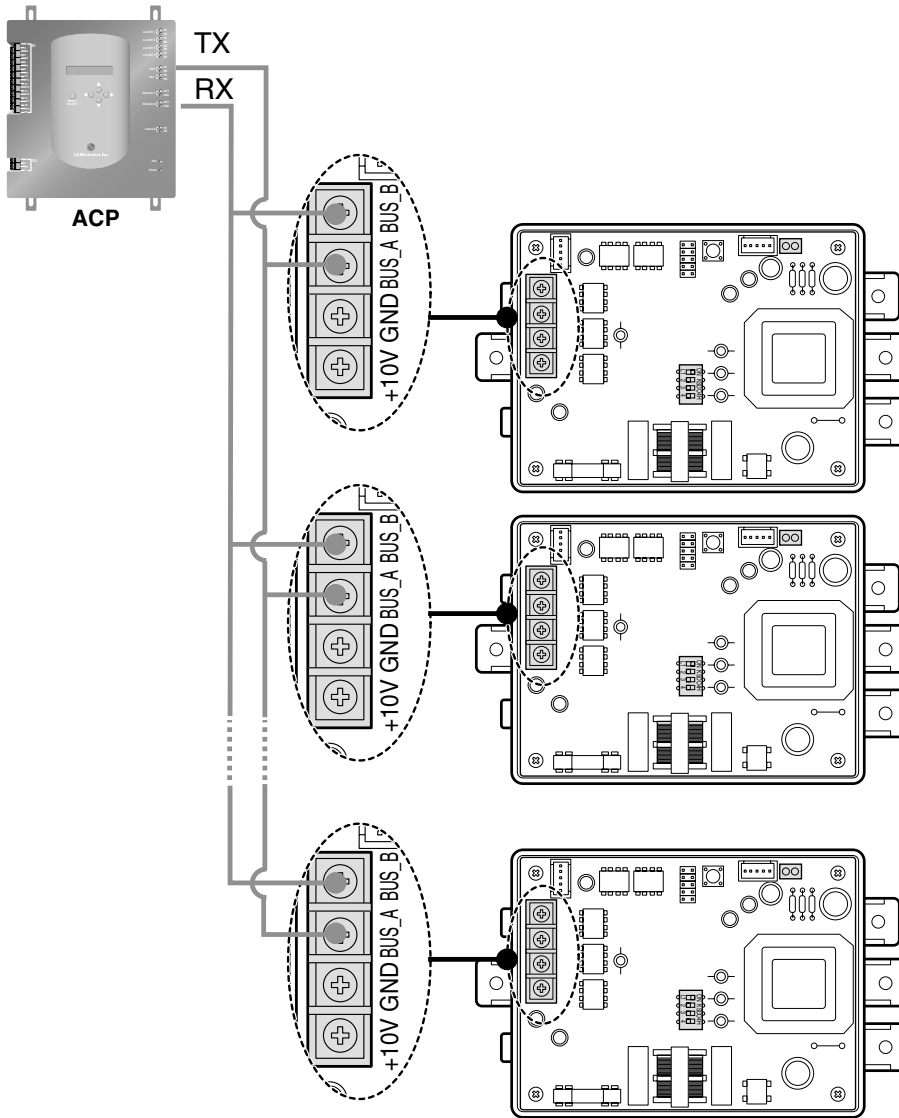

Tip: Connection setup when using the simple central controller together with the ACP

The simple central controller can be used with the ACP. Connect the simple central controller to the ACP as follows:

Note: Checking the LGAP Label
 Check the LGAP Label at the right side of the case of the simple central controller. Only the product with the label can be together connected to the ACP.
 The VCC and the GND terminals of the simple central controller should be connected to the wire from the PI485 or the separate adaptor. For more information, see the manual for the simple central controller.

1. Connect the BUS-A and the BUS-B ports of the PI485 to the terminals C and D of the simple central controller by using the RS485 communication cable.
2. Set the rotary switch of the simple central controller to match with the group number of the indoor unit to be controlled. For example, in order to control the indoor units with the addresses 00~0F, set the rotary switch to 0.
3. Set the DIP switch No. 1 of the simple central controller to OFF (slave) and No. 2 to ON (LGAP mode).

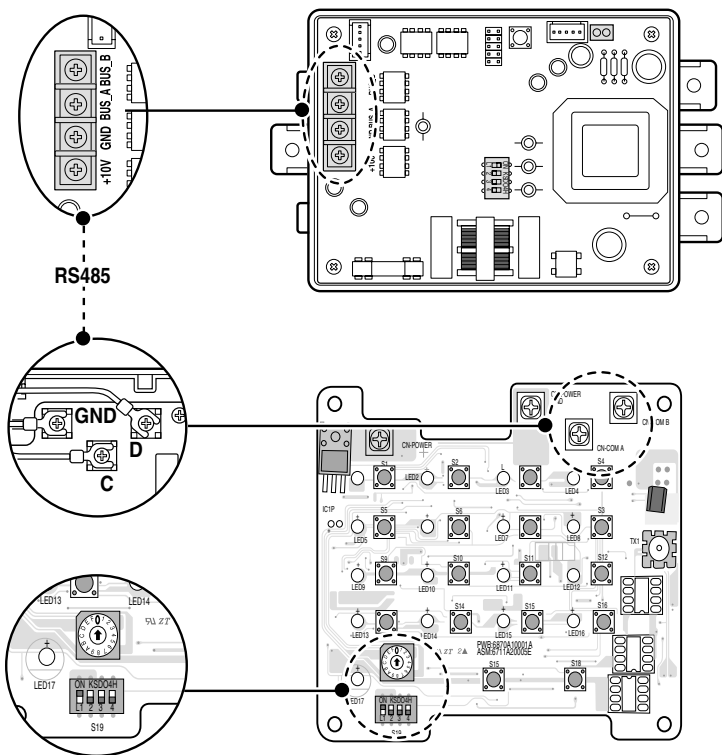

Installing the ACP and Connecting the cable

After setting the PI485, the ACP should be installed at the suitable place and the RS485 cable should be connected to communicate with the PI485. And, the Ethernet cable should be connected for connecting to the Internet or the AC Manager.

Fixing the ACP at the installation site

The ACP is basically designed to be installed at the wall to use. Install the ACP at the suitable place as the following description. Here, the installation method of the ACP is described with the example installing the ACP at the wall.

1. Decide the space to install the ACP. Before installing the ACP, check whether the place is suitable for connecting the ACP and the RS485 cable.
2. Use the screw driver to fix them at the wall. It can be fixed as shown at the following figure according to the installation place.

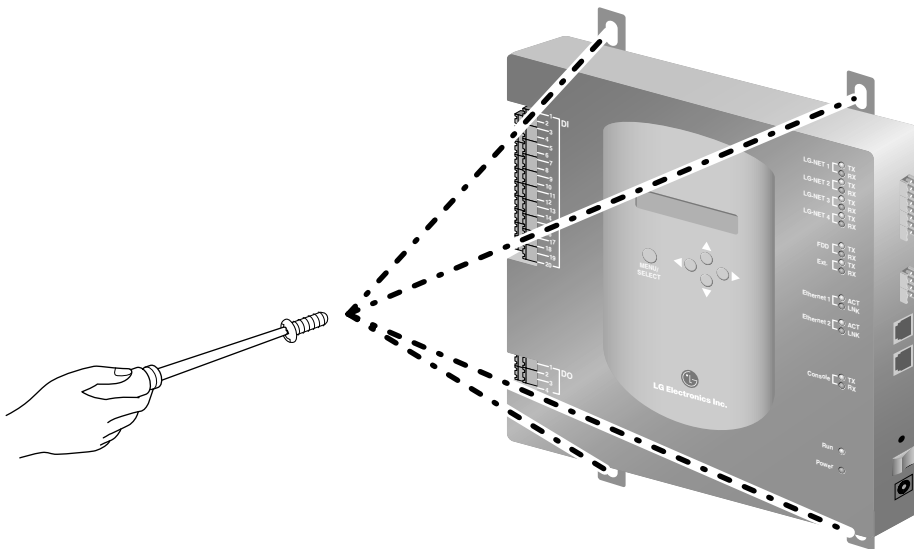

Connecting RS485 cable to ACP

After fixing the ACP at the installation place, the RS485 cable connecting the PI485 to the ACP. Connect the RS485 cable to the ACP as follows:

1. The end of the RS485 cable connecting to the BUS_A of the PI485 of the connector possible to be connected to the ACP to the TX. Next, connect the end of the RS485 cable connecting to the BUS_B of the PI485 to the RX.

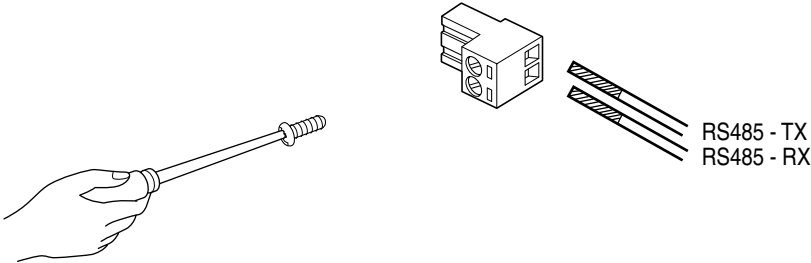

Caution: Connecting the RS485 communication cable



Because the connection of the RS485 communication cable has a polarity, be careful that the connection of two cables is not changed.

2. The RS485 cable connecting to the PI485 to the LG-NET port (RS485 port) of the ACP. Connect the connector connecting the RS485 cable to one of the ports LG-NET1~LG-NET4. The number of LG-NET ports is 1~4 and it is possible to connect to any of them to use.

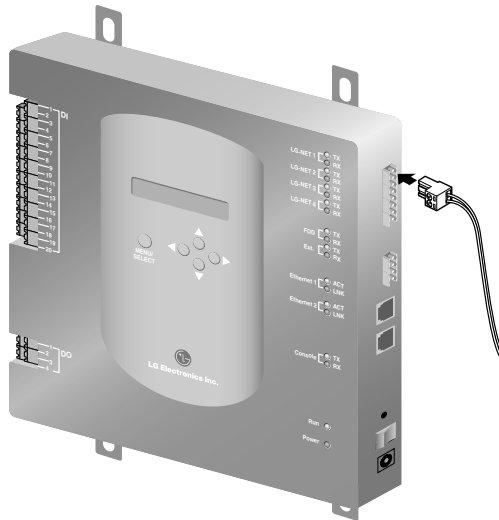

Tip: Connecting the RS485 of the ACP

64 outdoor units at maximum can be connected to one port of the RS485 of the ACP and 256 indoor units at maximum can be connected to one ACP. When there are many outdoor units to connect, connect the outdoor units suitably from LG-NET1 to LG-NET4 with the BUS form. Otherwise, the ACP may cause the malfunction.

The following figure shows the example for separately connecting the LG-NET1 and the LG-NET2 with the BUS form.

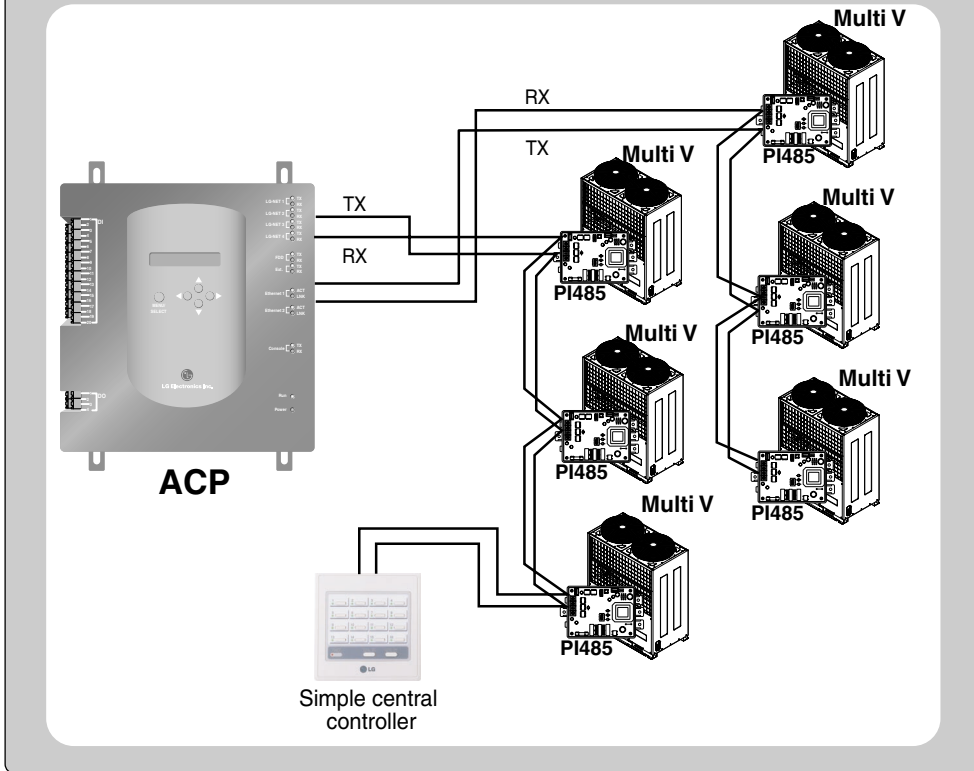

The following figure shows the example of the incorrect connection of the RS485 of the ACP.

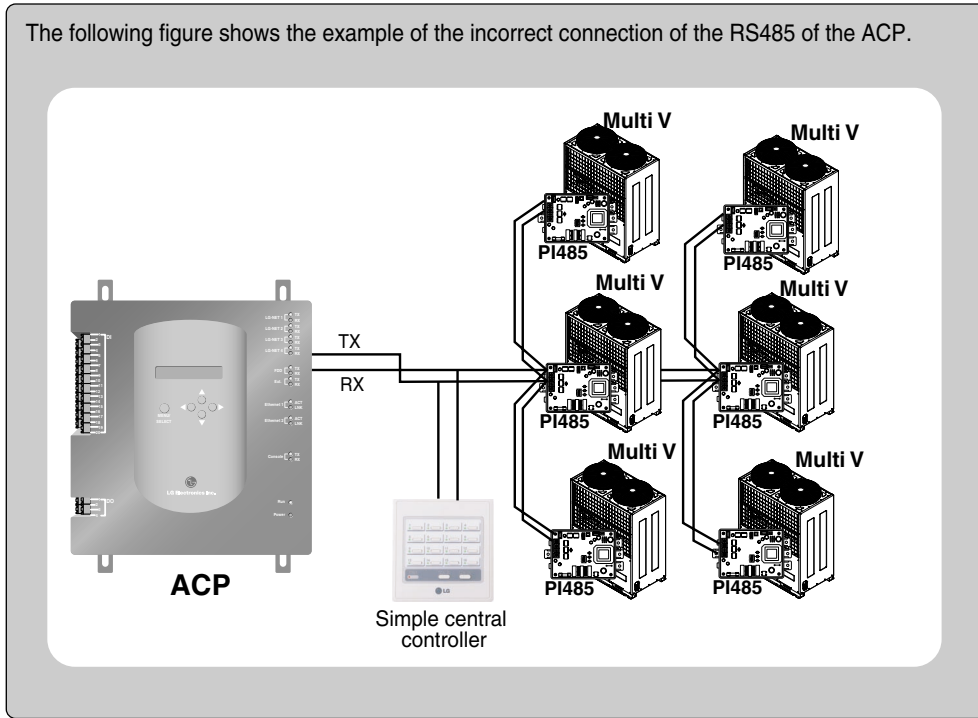

Connecting Ethernet cable to ACP

After connecting the ACP and the RS485 cable, the Ethernet cable should be connected to the ACP. The ACP can be connected to the hub via the Ethernet cable or directly to the AC Manager.

Connecting the ACP and the hub

The ACP is connected to the basic Internet network installed at the field, generally to the hub. In this case, the Ethernet cable should be connected by the direct cable.

Use the Ethernet cable (direct cable) to connect to the Ethernet 1 port of the ACP.

Connecting the ACP and the AC Manager

It is the case installing the AC Manager to the separate PC and directly connecting the ACP to the PC. In this case, the Ethernet cable should be connected by the cross cable.

Use the Ethernet cable (cross cable) to connect to the Ethernet 1 port of the ACP.

Caution: Ethernet cable type



It should be identified whether the Ethernet cable to be connected is the direct cable or the cross cable. Also, connect the cable by using the LAN tester to check whether the cable has any problem. For more information about the direct cable and the cross cable, see Chapter 4. UTP cable connection chart.

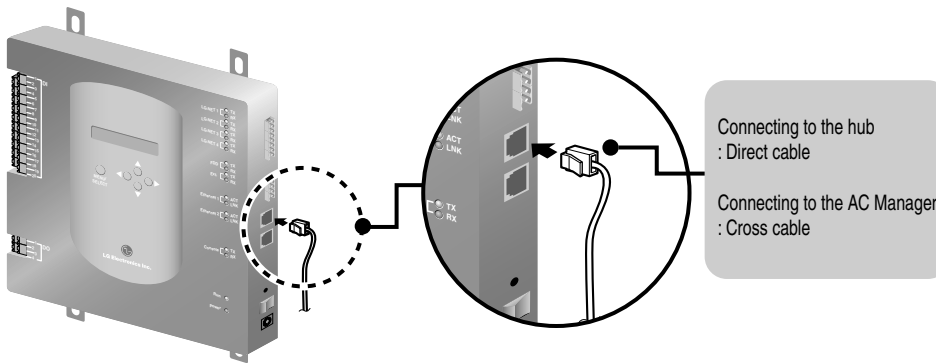

Note: Ethernet 2 port

Because the Ethernet 2 is the spare port, it is not used to connect to the hub and the AC Manager. Check the location of the Ethernet 1 port and the Ethernet 2 port and connect them correctly.

Connecting Power adaptor to ACP

After connecting the Ethernet cable, the power adaptor should be connected for supplying the power to the ACP.

1. Connect the power adaptor supplied with the ACP product to the power adaptor connection port of the ACT as shown at the below figure.

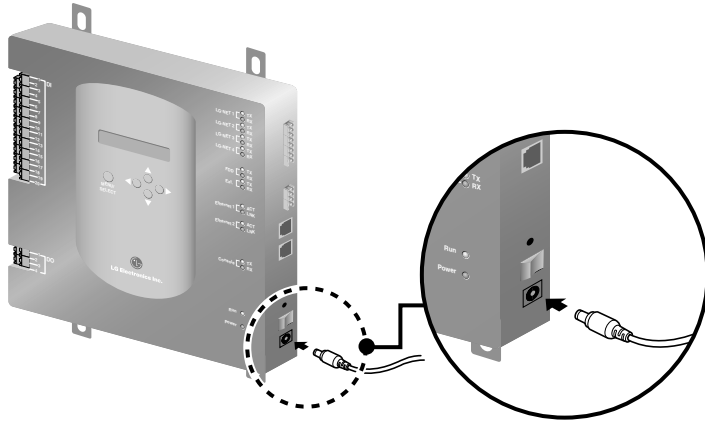

2. After connecting the power adaptor, connect the power cord connected to the power adaptor to the outlet.

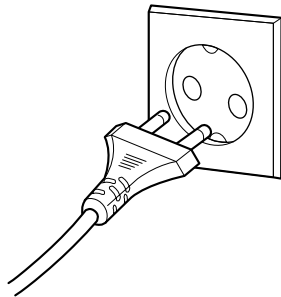

Configuring the ACP network

After connecting the ACP to various devices via the cable, the network environment of the ACP should be set by driving the ACP. The following information should be set for using the ACP.

- IP address of the ACP
- Gateway address
- Net mask address

Caution: Setting the network environment information



If the above information is not entered, the communication error may be occurred or it may be impossible to control by the ACP. So, be careful to correctly input.

Before configuring the ACP environment

The network environment of the ACP can be set by the LCD and the buttons at the front side of the ACP. The current ACP information and the menu are displayed at the LCD, and the menu can be changed and selected by pressing 'MENU/SELECT' button and Up/Down/Left/Right (▲, ▼, ◀, ▶) buttons.

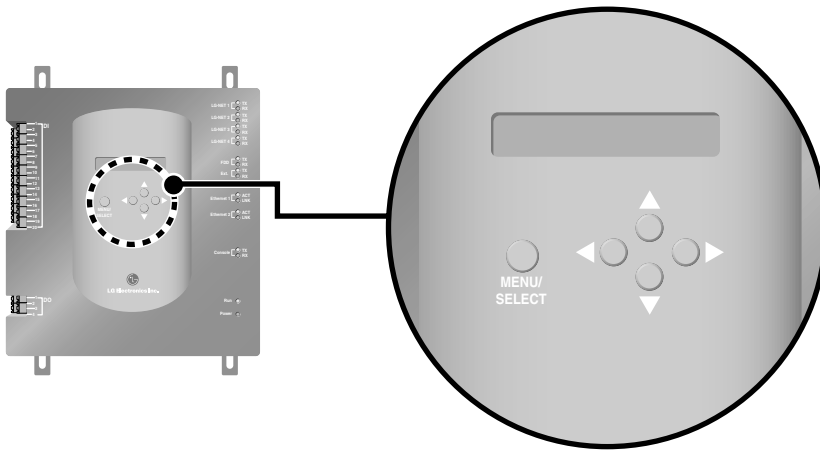

Turning on the ACP

Turn on the ACP to set the network environment of the ACP.

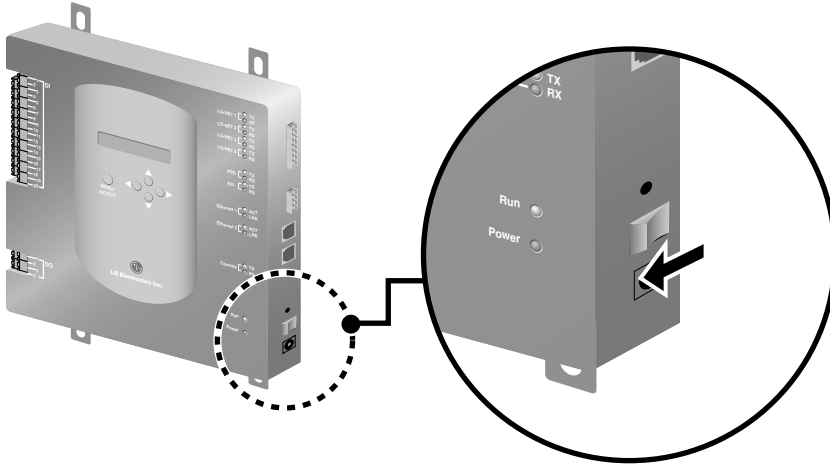

When the power switch is turned on, the ACP booting screen is displayed on the LCD as shown at the below figure, and when booting is completed, the initial ACP screen is displayed.

ACP booting screen

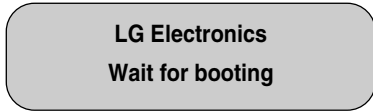

Initial ACP screen

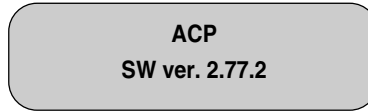

Note: Software version

The software version of the current ACP is displayed at the initial ACP screen. Also, the software version may be different according to the manufacturing date of the ACP.

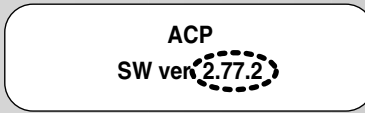

Entering into the environment setup mode

Press 'MENU/SELECT' button of the ACP to enter into the environment setup mode of the ACP. When the 'MENU/SELECT' button is pressed for the first time, the menu to set the IP address is displayed as shown below.

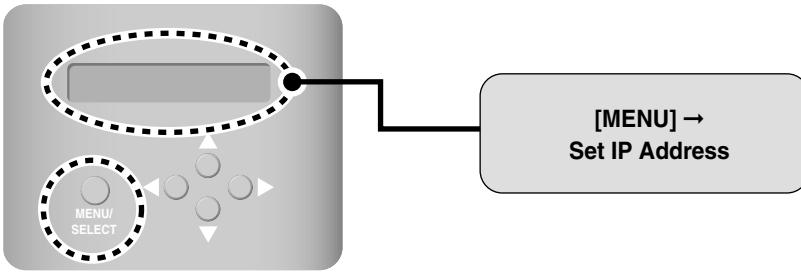

Select the desired function by pressing the left/right button (◀, ▶). Whenever the left/right button (◀, ▶) is pressed, the menu is changed as shown below.

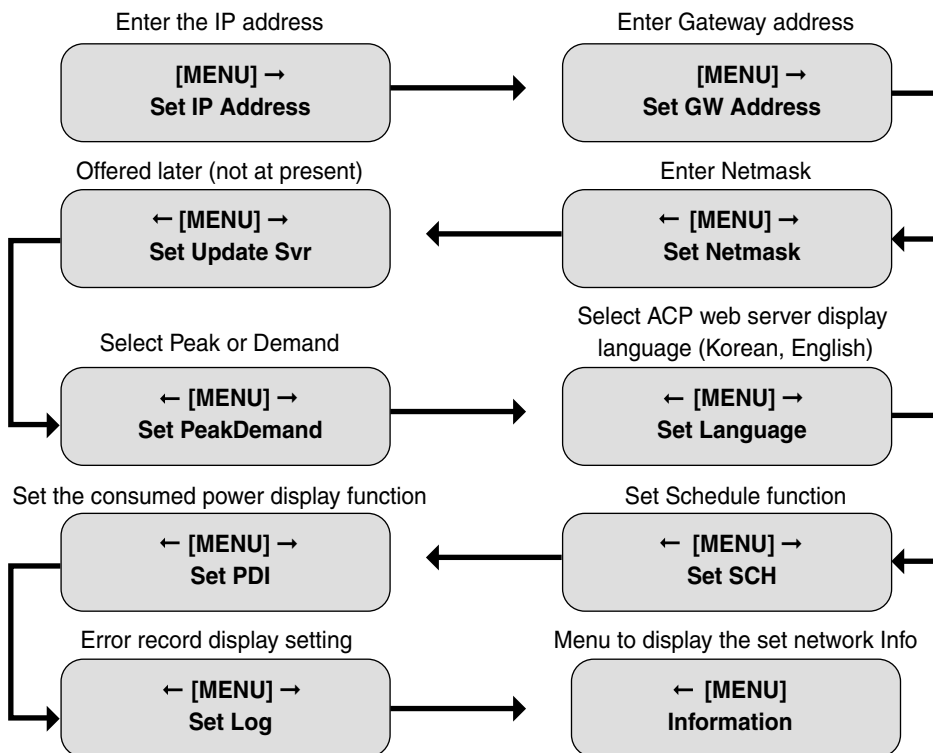

Press the 'MENU/SELECT' button at the desired function to enter into the setup screen for the related mode.

How to set the network address

The network address consists of four 3-digit numbers. In case of setting the network address, the name of the related address is displayed on the LCD of the ACP. Press Up/Down/Left/Right (▲, ▼, ◀, ▶) button to set.

Press Up/Down (▲, ▼) button to increase/decrease the number of the digit where the cursor is placed, and press Left/Right (◀, ▶) button to move the digit of the network address.

When pressing the down(▼) button

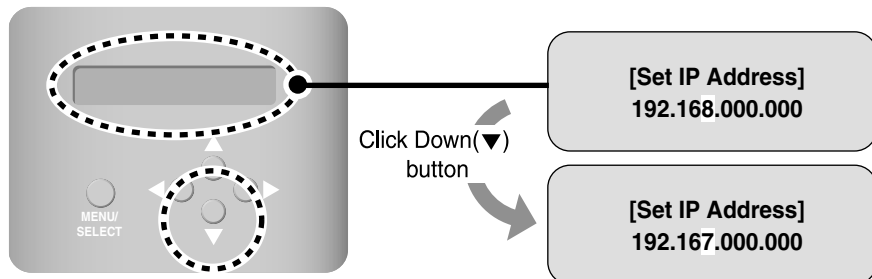

When pressing the right(▶) button

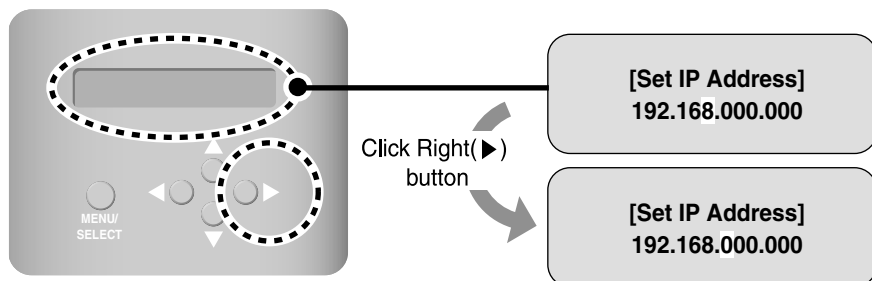

Also, in order the sum of three numbers not to exceed 255, the first digit of each address is set only when the second digit is set to less than or equal to 4. At the following example, '1' can not be changed to '2.' In this case, it can be changed after '6', the next digit, is set to less than or equal to '4.'

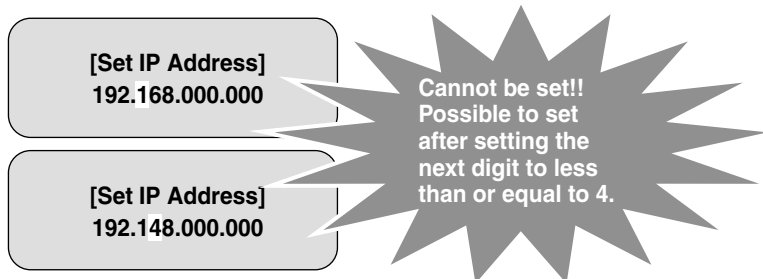

Setting the IP address

In order for the user to use the functions of the ACP via the web, the unique IP address should be given to the ACP. Set the IP address as follows:

1. Press the 'MENU/SELECT' button of the ACP. [MENU] screen is displayed as shown at below. Press the 'MENU/SELECT' button again. The screen to enter the IP address is displayed.

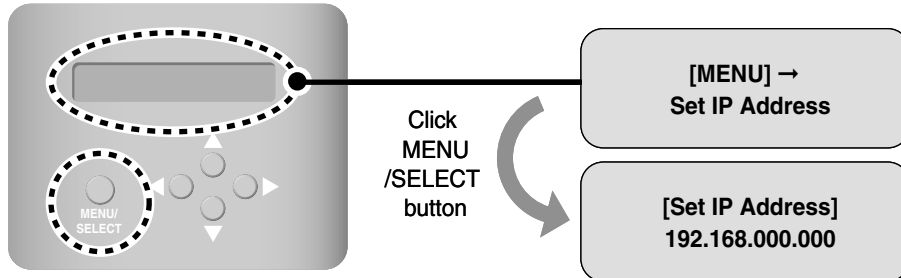

2. Use Up/Down/Left/Right (▲, ▼, ◀, ▶) button to enter the desired IP address.

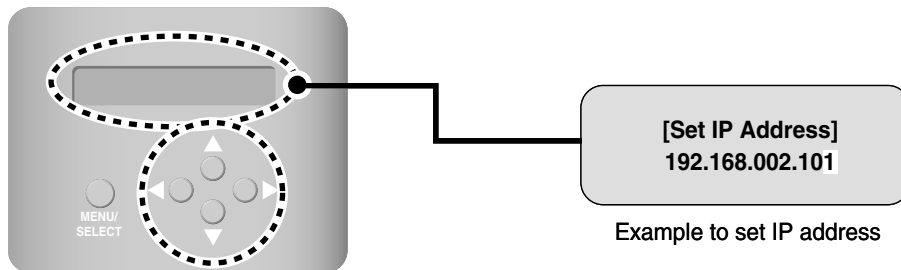

3. After entering the IP address, press the 'MENU/SELECT' button to set the entered IP address. But, there is no 'MENU/SELECT' button pressed for a specific period (about 5 seconds), it returns to the initial screen with the entered IP address not applied to the system, and the existing set IP address is used.

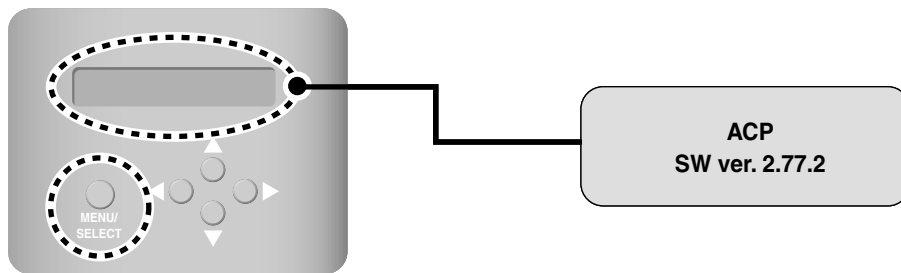

Setting the gateway address

After setting the IP address, the gateway address should be set. Set the gateway address as follows:

1. Press the 'MENU/SELECT' button of the ACP and then press Left/Right (◀, ▶) button to display the following Gateway setup screen. Press the 'MENU/SELECT' button again. The screen to enter the gateway address is displayed.

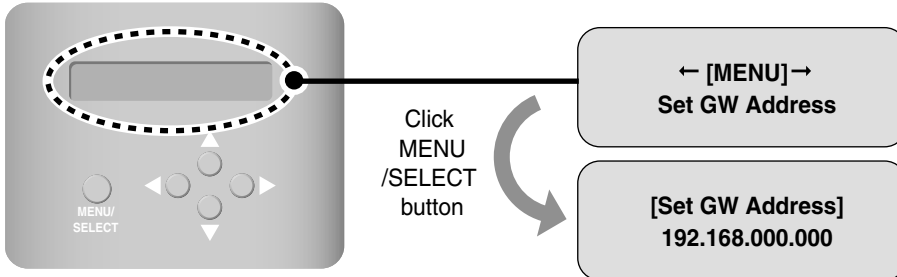

2. Use Up/Down/Left/Right (▲, ▼, ◀, ▶) button to enter the desired gateway address.

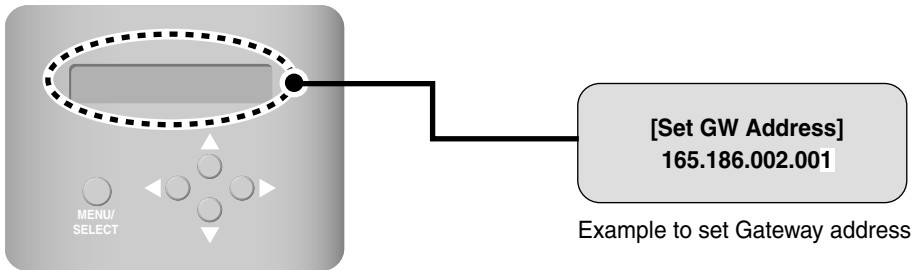

3. After entering the gateway address, press the 'MENU/SELECT' button to set the entered gateway address. But, there is no 'MENU/SELECT' button pressed for a specific period (about 5 seconds), it returns to the initial screen with the entered gateway address not applied to the system, and the existing set gateway address is used.

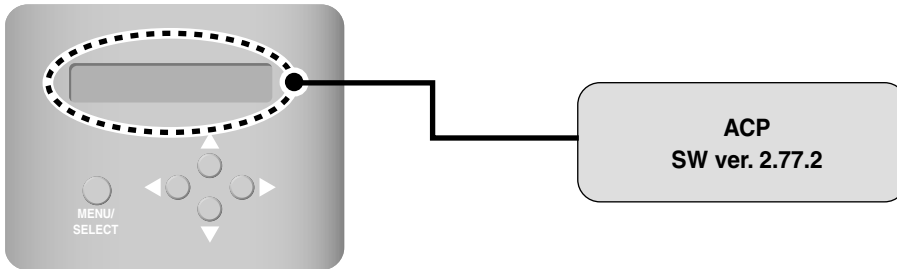

Setting the netmask address

After setting the gateway address, the netmask address should be set. Set the netmask address as follows:

1. Press the 'MENU/SELECT' button of the ACP and then press Left/Right (◀, ▶) button to display the following Netmask setup screen. Press the 'MENU/SELECT' button again. The screen to enter the netmask address is displayed.

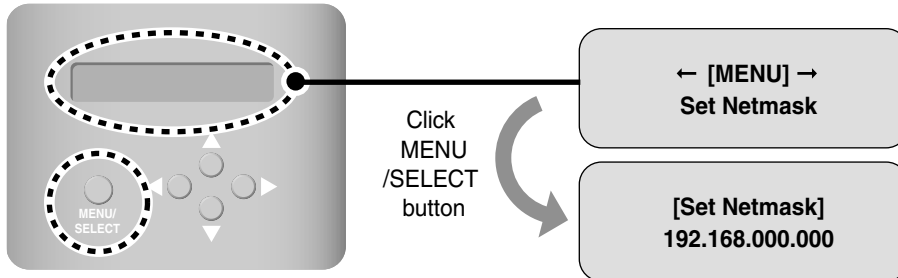

2. Use Up/Down/Left/Right (▲, ▼, ◀, ▶) button to enter the desired net mask address.

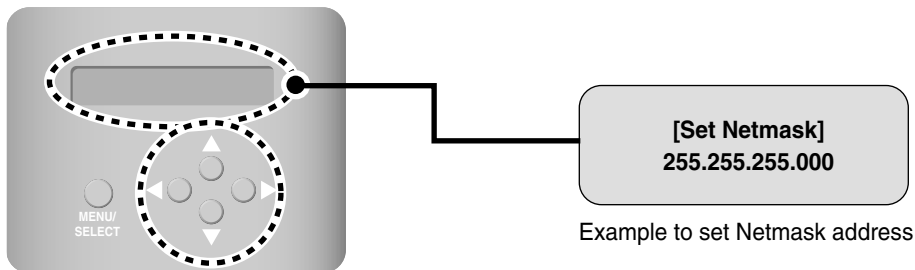

3. After entering the netmask address, press the 'MENU/SELECT' button to set the entered netmask address. But, there is no 'MENU/SELECT' button pressed for a specific period (about 5 seconds), it returns to the initial screen with the entered netmask address not applied to the system, and the existing set netmask address is used.

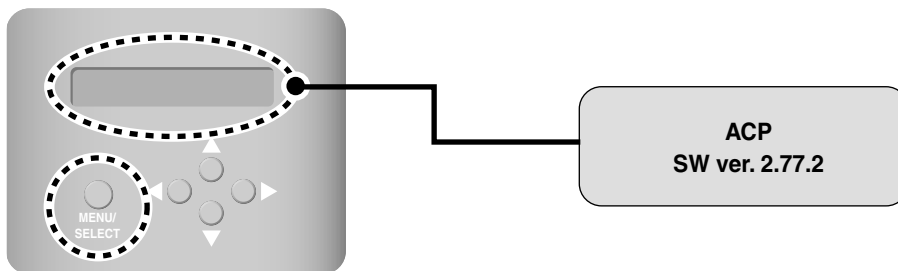

Checking the network environment

When the IP address, the gateway address, and the netmask address are set, the essential network environment setup of the ACP is completed. So, make sure that all settings are successfully completed.

Check the network environment setting as follows:

Press the 'MENU/SELECT' button of the ACP and then press Left/Right (◀, ▶) button to display the following Information screen. Press the 'MENU/SELECT' button again. The currently set network information can be checked.

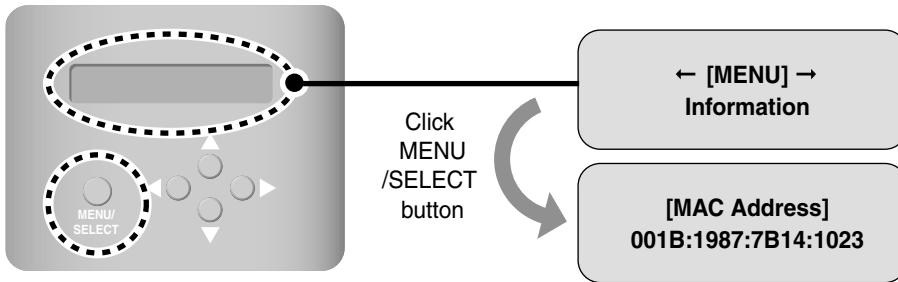

Each different information is displayed on the LCD screen about every 3 seconds. It is displayed as follows:

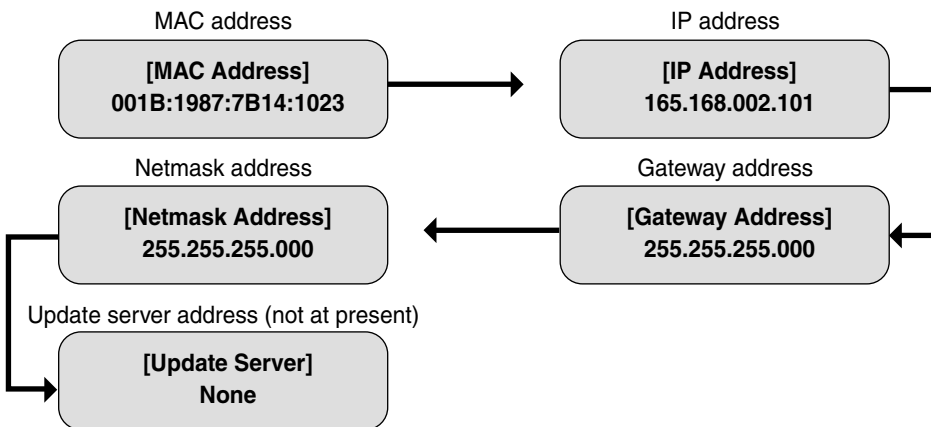

Setting the functions of the ACP

The following functions can be set by using the menu of the ACP:

- Select Peak or Demand
- Select the web display language
- Set the schedule to use
- Set the wattage display to use

Before setting the functions of the ACP

The function setting of the ACP should be changed depending on the case that only the ACP is used or the case that the ACP is interconnected with the external devices such as AC Manager, Wattmeter and Demand controller.

In general, the function of the ACP should be set and used as follows:

	ACP only	ACP interconnected with AC Manager	ACP interconnected with Demand controller
Select Peak or Demand	Set to Peak function	Set to Demand function	Set to Demand function
Schedule	Set the schedule function to use	Set the schedule function not to use	Set the schedule function to use
Wattage display	Set to use if interconnected with the wattmeter or set not to use if not.		

Caution: Setting the wattage display to use



If the ACP and the wattmeter are not connected, the wattage display function should be set not to use. If it is set to use, be careful of it because the control speed of the ACP is getting slow.

Selecting Peak or Demand

The ACP offers the function to manage the wattage consumed by the connected air conditioner, by which the electric charges can be effectively saved. The ACP offers two functions to limit the peak wattage of the air conditioner as follows:

- Peak: The peak wattage of the air conditioner can be managed by setting the peak wattage to the ACP.
- Demand: The ACP and the Demand Controller are connected without any separate software. When the current wattage exceeds the target value, the wattage of the air conditioner can be restricted by interconnecting with other power device to set the total target wattage.

One of these methods can be selected and used at the ACP. And, if it is set by the menu of the ACP, the UI screen is differently displayed when accessing the web screen to set the function. The ACP should be set to the Demand function for the following cases:

- Interconnecting with the Demand Controller of the professional Demand control company
- Interconnecting with the AC Manager

Note: Default value

The default value when shipped from the factory is set to Peak.

Change the wattage control method as follows:

1. Press the 'MENU/SELECT' button of the ACP and then press Left/Right (◀, ▶) button to display the following Peak/Demand setup screen. Press the 'MENU/SELECT' button again. The screen to set Peak or Demand method is displayed.

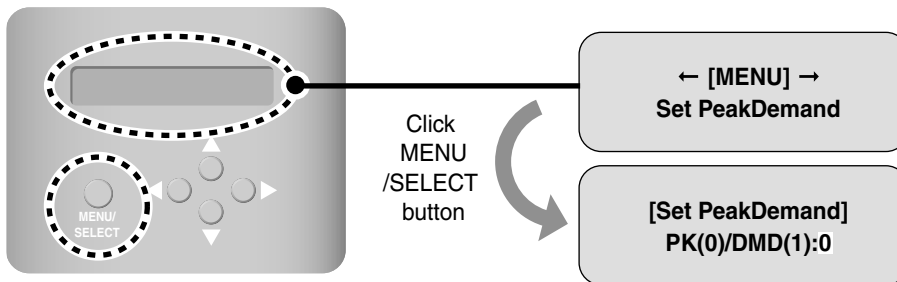

2. Use Up/Down (▲, ▼) button to set the desired wattage control method. Press the Up (▲) button to set the Peak method, or press the Down (▼) button to set the Demand method.

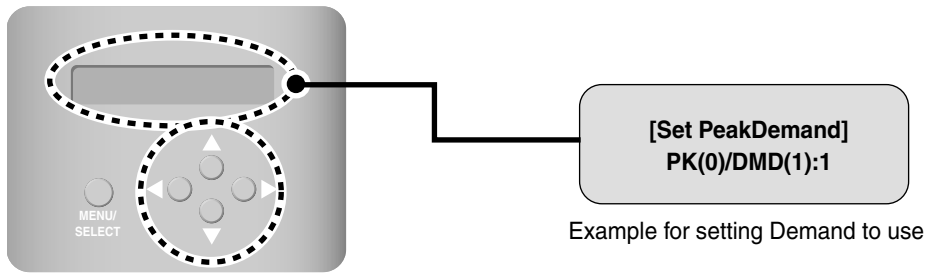

3. When the 'MENU/SELECT' button is pressed, the set wattage control method is applied to the system. But, there is no 'MENU/SELECT' button pressed for a specific period (about 5 seconds), it returns to the initial screen with the set control method not applied to the system, and the existing set method is used.

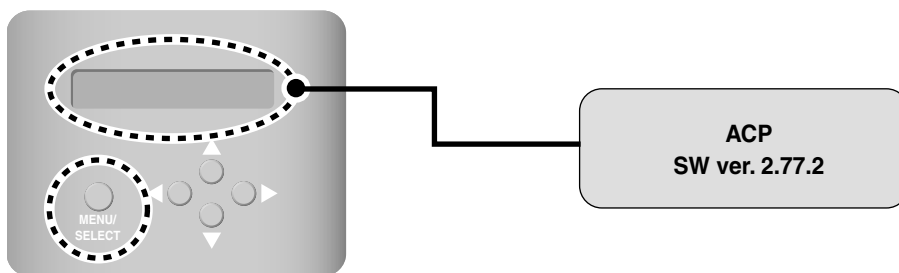

Selecting ACCS display language

The ACP offers the web server function. So, when the user accesses the ACP by using the Internet Explorer at the computer connecting to the ACP, the LG ACCS (Advanced Centralized Control System), the control program to use the functions of the ACP, is displayed.

Note: How to use the LG ACCS

For more information on the method to use the LG ACCS, see Chapter 3. ACP operation by using the ACCS

The following figure is the initial screen of the LG ACCS program.

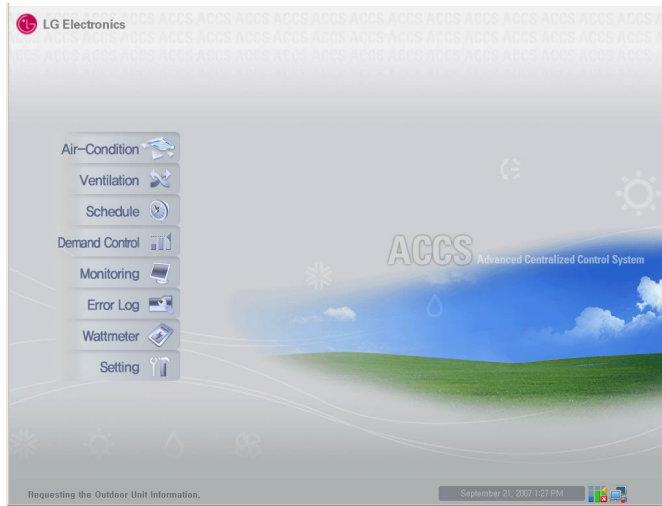

The LG ACCS is offered with the Korean version and the English version, which can be changed by the user's setting. Change the language setting of the LG ACCS as follows:

1. Press the 'MENU/SELECT' button of the ACP and then press Left/Right (◀, ▶) button to display the following language setup screen. Press the 'MENU/SELECT' button again. The screen to set the display language is displayed.

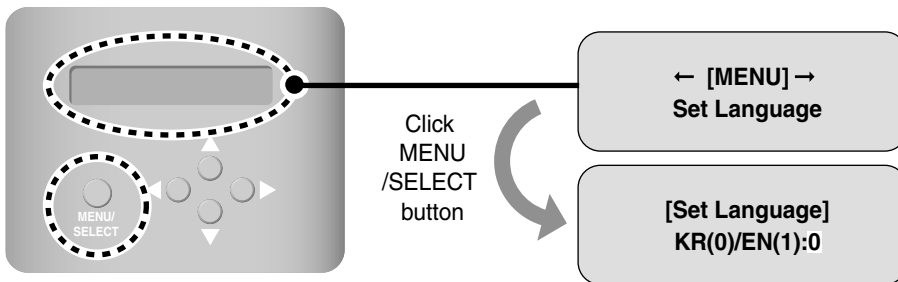

2. Use Up/Down (▲, ▼) button to set the desired language. Press the Up (▲) button to display in English (1), or press the Down (▼) button to display in Korean (0).

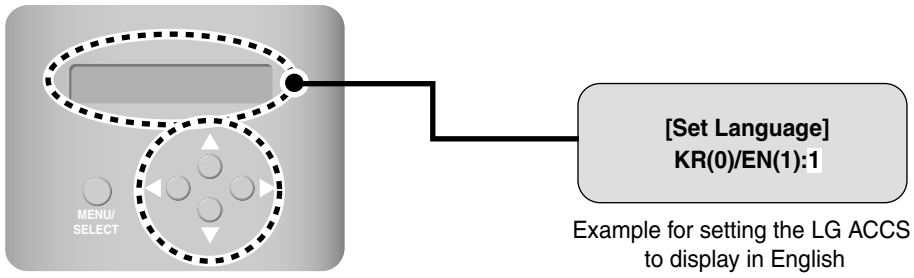

3. When the 'MENU/SELECT' button is pressed, the set display language is applied to the system. But, there is no 'MENU/SELECT' button pressed for a specific period (about 5 seconds), it returns to the initial screen with the set display language not applied to the system, and the existing set method is used.

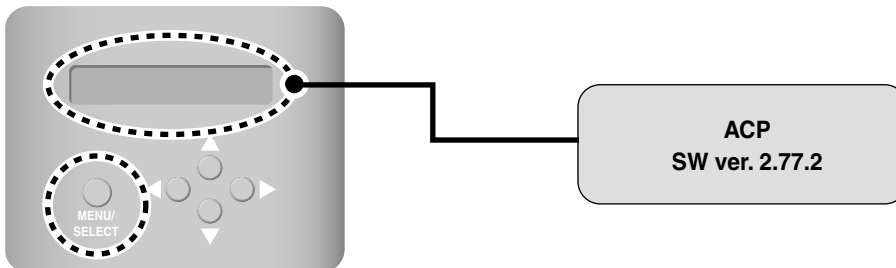

Setting whether to use the schedule function or not

The LG ACCS, the operation program of the ACP, offers the schedule setup function for the indoor unit of the air conditioner connected to the ACP to automatically operate at the specified time. Whether to use the schedule function at the ACP or not should be set.

Caution: Deciding whether to use the schedule function or not



When the ACP and the AC Manager are interconnected, the ACP has the preemptive priority to use the schedule function of the AC Manager, so it should be set not to use the schedule function of the ACP. When only the ACP is operated, the schedule function of the ACP can be used.

Set whether to use the schedule function as follows:

1. Press the 'MENU/SELECT' button of the ACP and then press Left/Right (◀, ▶) button to display the following schedule function setup screen. Press the 'MENU/SELECT' button again. The screen to set whether to use the schedule function or not is displayed.

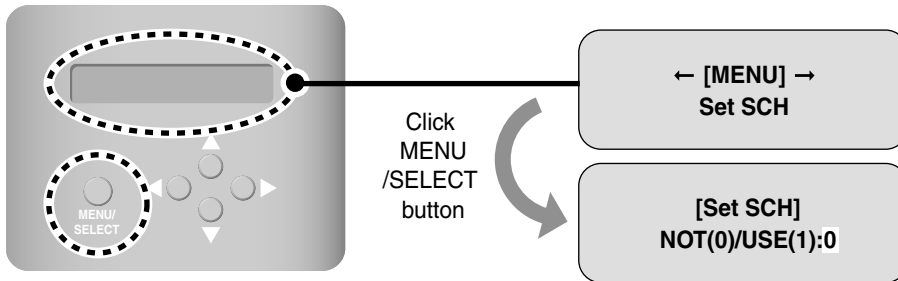

2. Use Up/Down (▲, ▼) button to set whether to use the schedule function or not. Press the Up (▲) button to use the schedule function, or press the Down (▼) button not to set the schedule function.

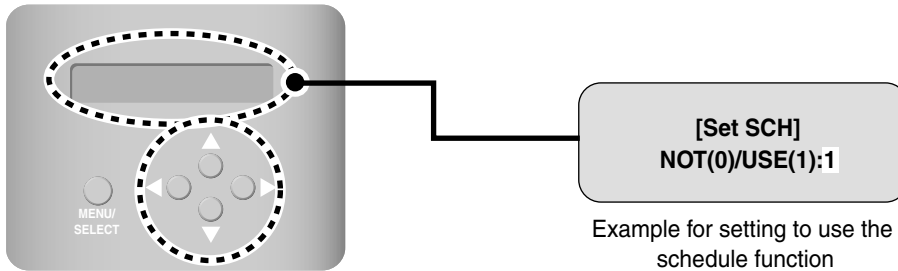

3. When the 'MENU/SELECT' button is pressed, whether to use the schedule function or not is applied to the system. But, there is no 'MENU/SELECT' button pressed for a specific period (about 5 seconds), it returns to the initial screen with the setting not applied to the system, and the existing set method is used.

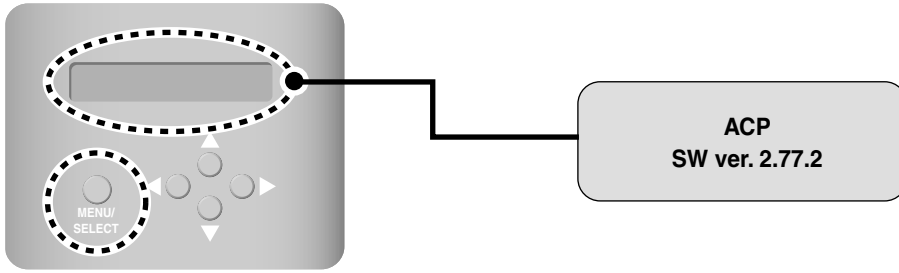

Setting whether to use the wattage display function or not

The LG ACCS, the operation program of the ACP, offers the wattage display interconnection function to check and manage the wattage of the indoor unit of the air conditioner connected to the ACP.

Caution: Wattage display interconnection



In order to use the wattage display interconnection function, the wattmeter should be connected and interconnected with the PI485 connecting to the ACP. See the related product manual for the installation and the operation of the wattmeter and the PI485.

In order to use the wattage display interconnection function with the wattmeter installed, whether to use it at the ACP or not should be set. Set whether to use the wattage display interconnection function as follows:

Set whether to use the wattage display interconnection function as follows:

1. Press the 'MENU/SELECT' button of the ACP and then press Left/Right (◀, ▶) button to display the wattage display setup screen. Press the 'MENU/SELECT' button again. The screen to set whether to use the wattage display or not is displayed.

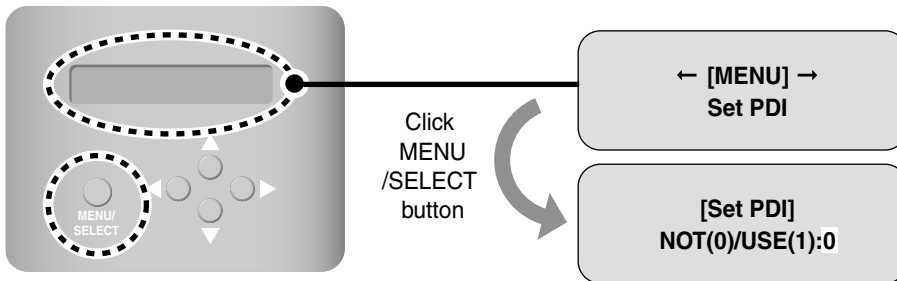

2. Use Up/Down (▲, ▼) button to set whether to use the wattage display function or not. Press the Up (▼) button to use the wattage display function, or press the Down (▲) button not to set the wattage display function.

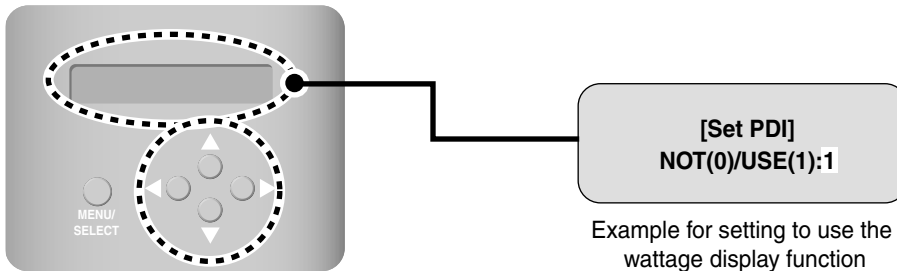

3. When the 'MENU/SELECT' button is pressed, whether to use the wattage display function or not is applied to the system. But, there is no 'MENU/SELECT' button pressed for a specific period (about 5 seconds), it returns to the initial screen with the setting not applied to the system, and the existing set method is used.

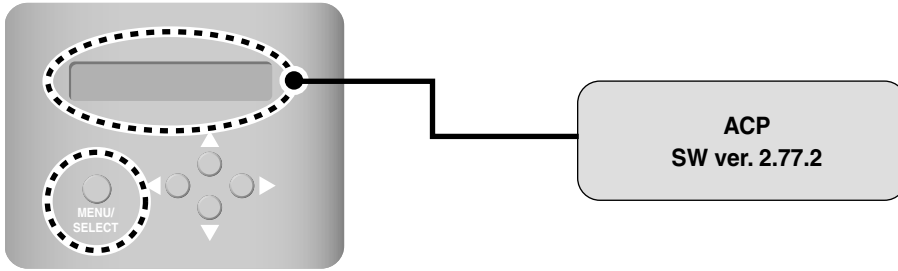

Setting error history display

LG ACCS, operating program of ACP, provides error history function to monitor various types of errors occurring in between the air condition and indoor unit connected to ACP. For the error history function, the user can select conveniently whether to display in LG ACCS or not.

The user must set whether to use the error history function in ACP. To set to use the error history function, proceed as follows.

1. After pressing the 'MENU/SELECT' button of ACP, press the left and right (◀, ▶) button to display the setting screen of the error history function as shown below. Once again, press the 'MENU/SELECT' button. The screen to set whether to use the error history function will be displayed.

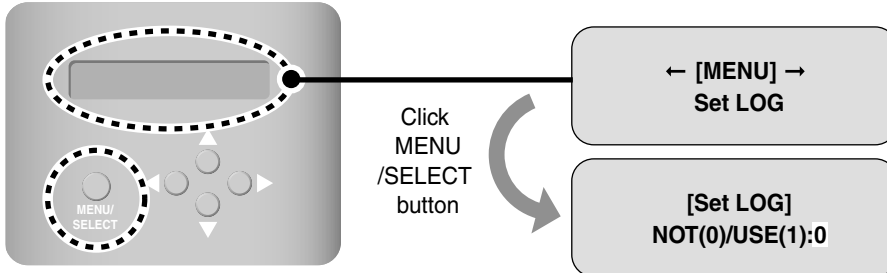

2. Use the up and down (▲, ▼) button to set whether to use the error history function. When you press the up (▲) button, it will be set to use the error history function and down (▼) button not to use the error history function.

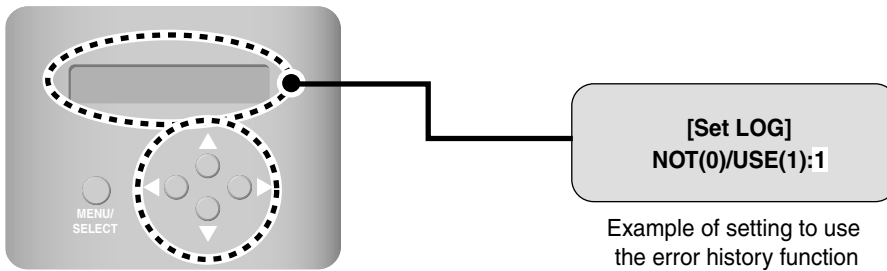

3. When you press the 'MENU/SELECT' button, setting of whether to use the error history function will be applied to the system. But if the 'MENU/SELECT' button is not pressed within a certain period of time (5 seconds), the setting will not be applied to the system and the system will return to the initial screen. The system will use the method set by the existing setting.

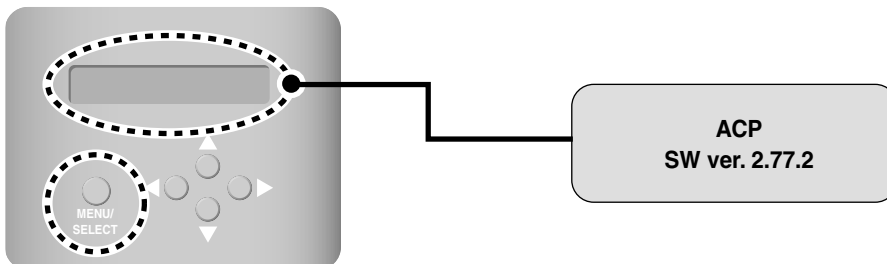

Configuring the ACCS access

The user can use the LG ACCS program at the computer connected with the ACP via the network to control the functions of the ACP. The LG ACCS (Advanced Centralized Control System) is the function control program of the ACP developed with the Java. The LG ACCS is automatically executed when the user accesses the ACP by using the Internet Explorer with no separate program installed.

Checking the MS JAVA VM installation

The MS JAVA Virtual Machine should be installed for accessing the LG ACCS program of the ACP. Because it is not automatically installed since the Windows XP version, the user using the Windows XP or higher version should manually install the MS JAVA Virtual Machine.

1. Execute [Start] → [Program] → [Internet Explorer] at the Windows.

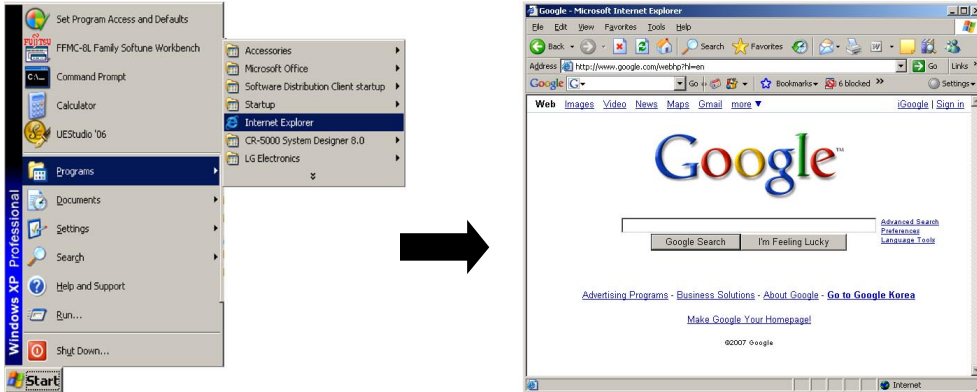

2. When the Internet Explorer is executed, execute [Tools] → [Internet Option] at the menu.

The 'Internet Option' window is displayed as follows:

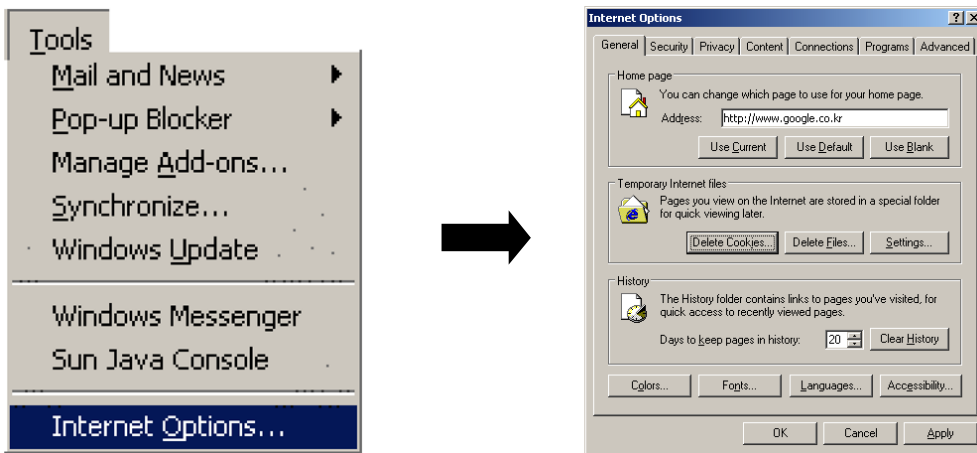

3. After selecting the [Advanced] tab at the 'Internet Option' window, check whether there is the 'Microsoft VM' item or not. If it is possible to check at the checkbox, the VM(Virtual Machine) is already installed at the Windows.

Check only the 'Use Java JIT Compiler (system rebooting required)' item at the 'Microsoft VM' item and unselect all other items. If 'JAVA (Sun)' item exists at 'Microsoft VM' item and it is checked, it should be unselected.

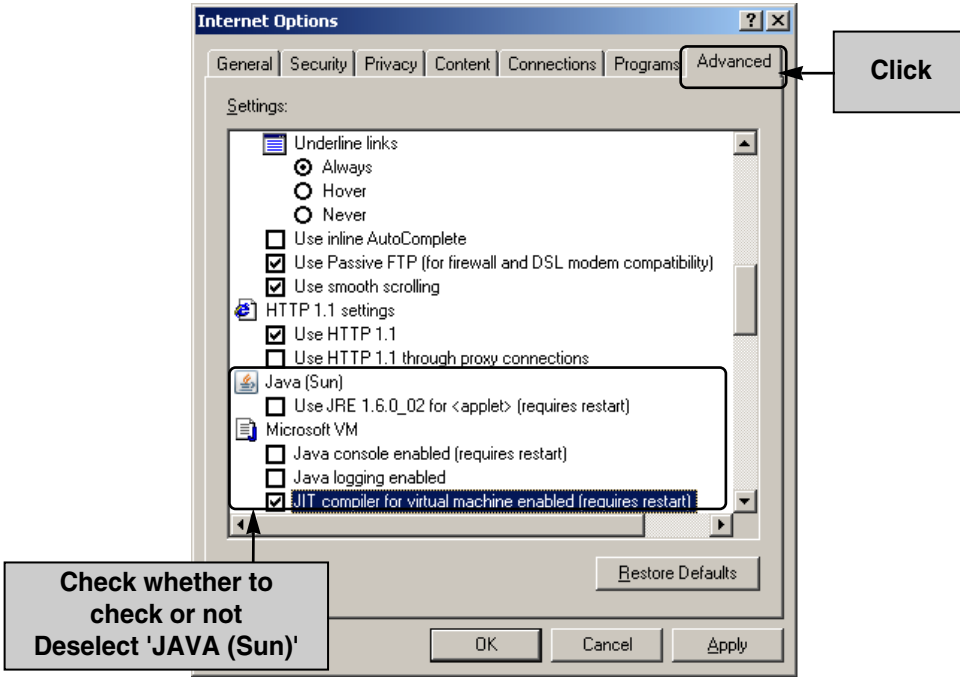

Caution: If Microsoft Java Virtual Machine is not installed



If the Java Virtual Machine of the Microsoft is not installed, 'msjv86.exe' file should be downloaded and installed by the search site.

Checking the MS Explorer security setting

For the stable operation of the LG ACCS (Advanced Centralized Control System), the security setting of the Microsoft Internet Explorer, a web browser, should be changed. Change the security setting of the Microsoft Internet Explorer by the following procedure. Here, it is described by the example changing the setting at the Windows XP operating environment.

1. Execute [Start] → [Program] → [Internet Explorer] at the Windows.

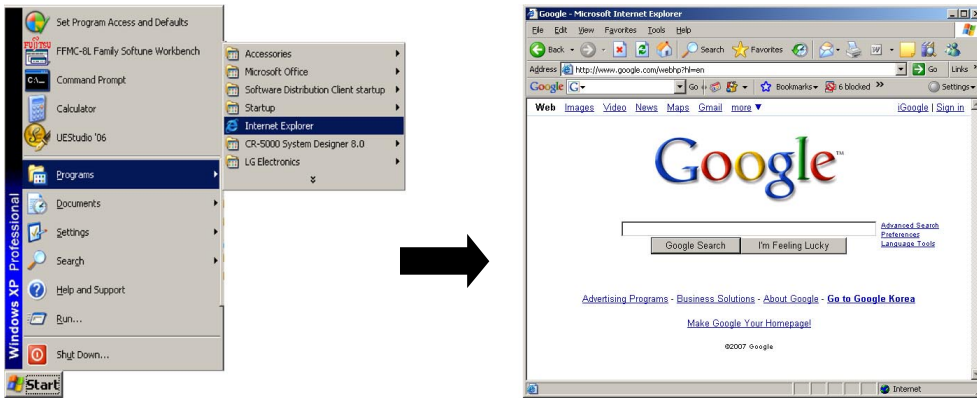

2. When the Internet Explorer is executed, execute [Tools] → [Internet Option] at the menu. The 'Internet Option' window is displayed as follows:

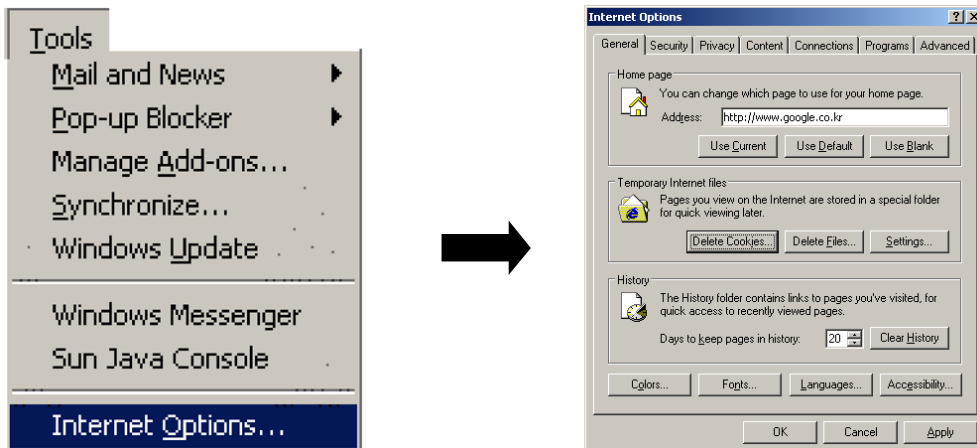

- After selecting the [Security] tab at the 'Internet Option' window, press [Custom Level] at the bottom. 'Security setup' window is displayed.

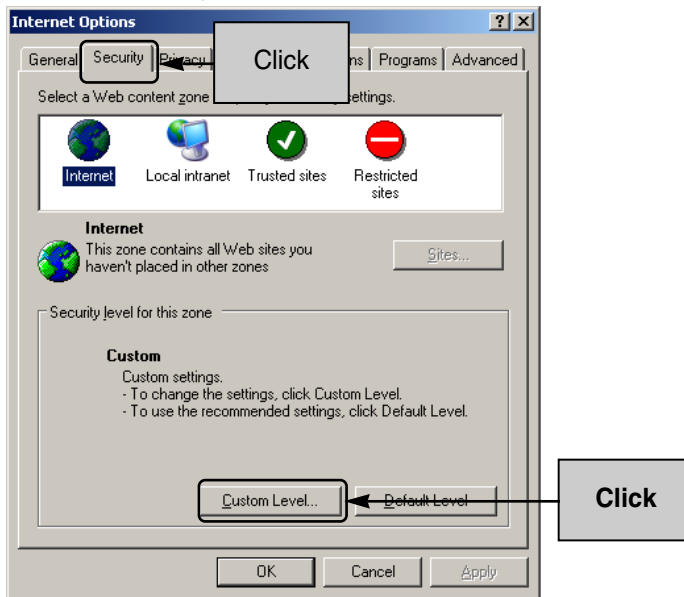

- When the 'Security setup' window is displayed, find out 'Microsoft VM' and check 'Custom'. When [Java Custom Settings] button is displayed later, click it. Then, 'Internet' window is displayed.

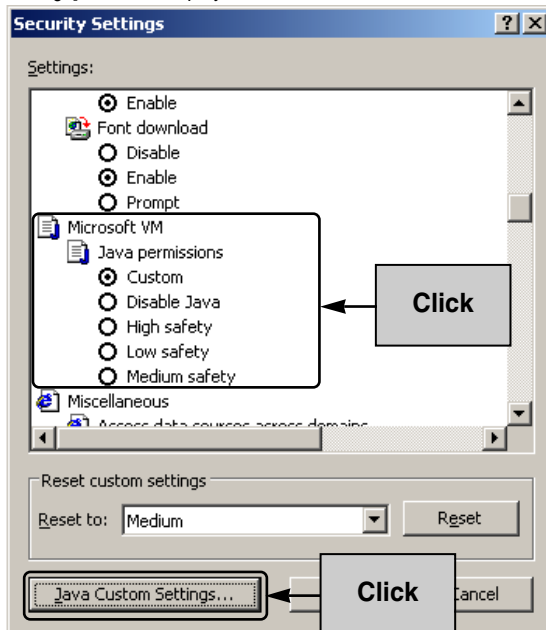

5. After selecting 'Edit Right' tab at the Internet window, set 'Run Unsigned Content' item to 'Enable.'
Press [OK] button to exit 'Internet' window.

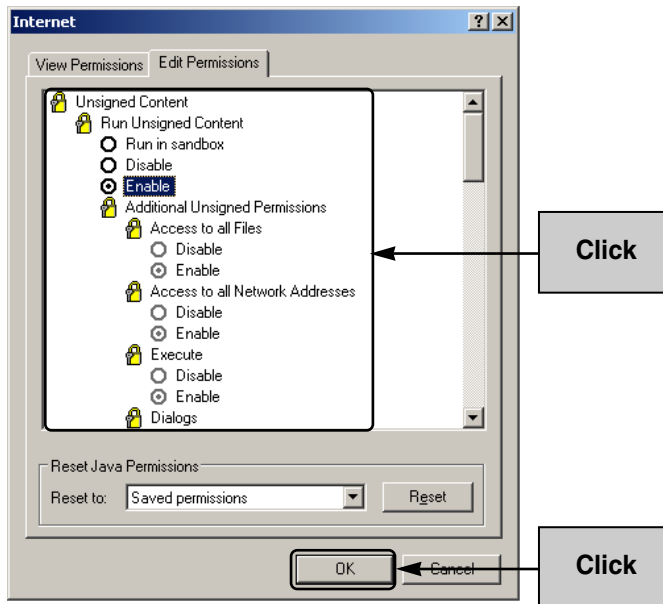

6. Press [OK] button at the previous 'Security setup' window. 'Warning!' window for checking the security setting is displayed. Press [Yes] button.

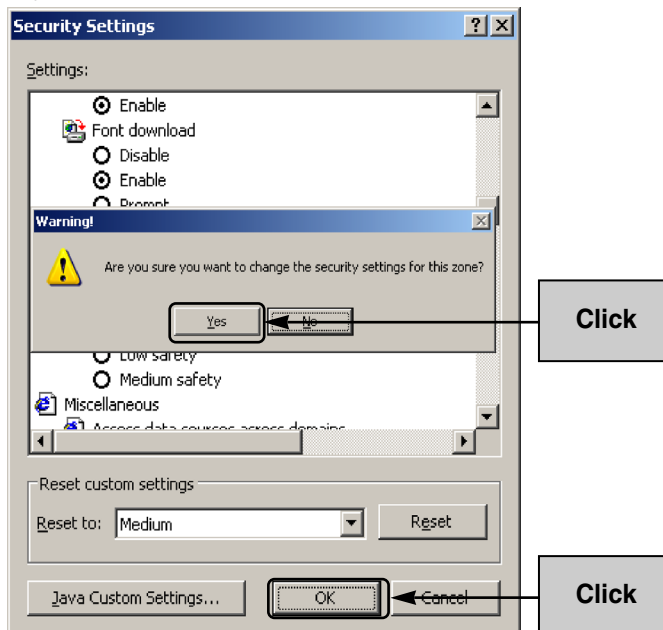

7. Finally, press [OK] button at the 'Internet Options' window. Now, the security setup to use the LG ACCS is completed.

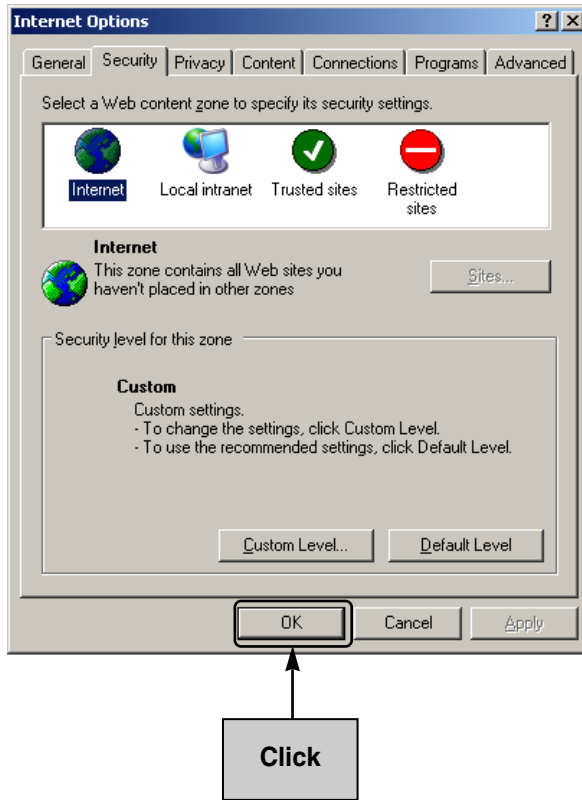

Entering the indoor unit & ventilator information

When the installation at the previous steps is completed, finally, the information of the outdoor unit, the indoor unit, and the ventilator connected to the ACP should be entered. The air conditioner can be controlled by using the ACP only after this information is entered.

There are two methods to enter the information of the outdoor unit, the indoor unit, and the ventilator depending on the condition as follows:

- When the ACP is connected to the AC Manager, register the information by using the AC Manager
- When the ACP is not connected to the AC Manager, register the information by using the LG ACCS program of the ACP

If the ACP is connected to the AC Manager

When the AC Manager is installed at the specific PC to connect to the ACP, the information set at the AC Manager is automatically entered into the ACP. So, the ACP can control the air conditioner even if the information of the outdoor unit, the indoor unit, and the ventilator is not entered.

Note: How to use the AC Manager

For more information to use the AC Manager, see the Owner's manual of the AC Manager.

If the ACP is not connected to the AC Manager

When the ACP is not connected to the AC Manager, the information of the indoor unit and the ventilator can be entered by using the LG ACCS (Advanced Centralized Control System) program of the ACP.

Accessing the LG ACCS

In order to enter the indoor unit information by using the LG ACCS program of the ACP, you should access the LG ACCS, first of all.

Access the LG ACCS at the PC connected to the internal network to which the Internet or the ACP can be connected as follows:

1. Execute the Internet Explorer at the PC connected to the ACP via the Internet or the internal network. And then, enter the IP address set at the ACP into the address window, and press [Enter] key.



Note: ACP access IP

If you don't know the access IP of the ACP, check the ACP setup IP by referring to Chapter 2. Configuring the ACP network – Checking the network environment.

2. When the IP address is correctly entered, the following LG ACCS Login screen is displayed. Enter the ID and the password and then click [Login] button.
Set the ID to 'admin' and the password to 'digital21' for the first access to the ACP.

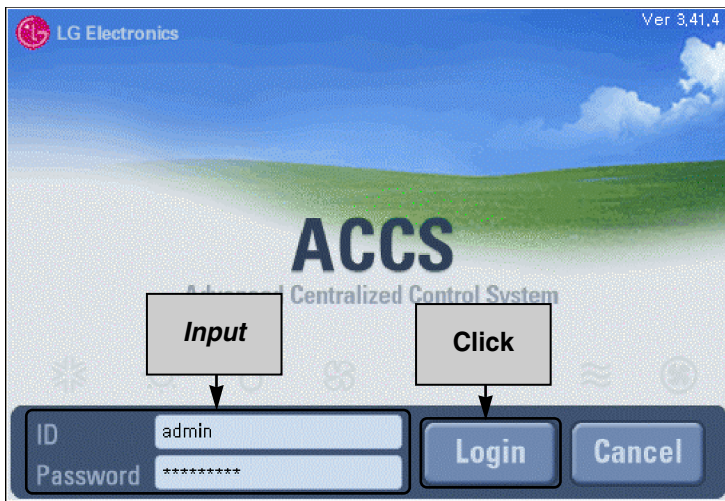

3. When the login is successfully done, the following access procedure will be executed.

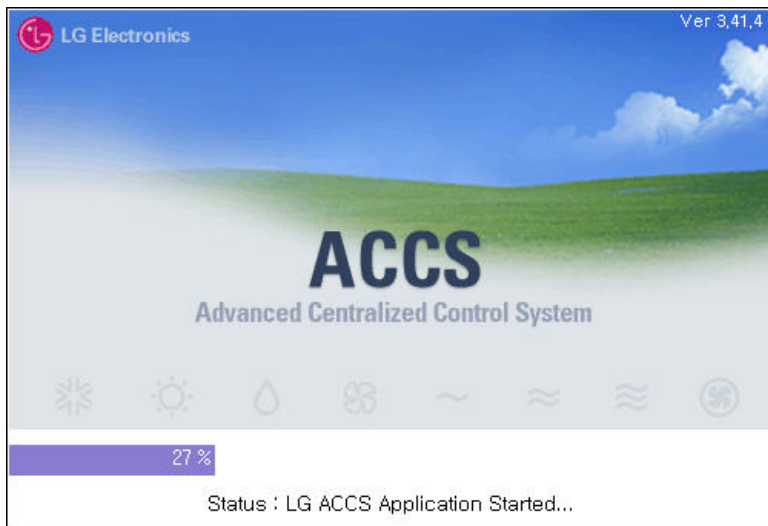

4. When the login is successfully done, the initial screen of the LG ACCS is displayed as shown at the below. Click [System setup] button, the last menu. The system setup screen to set the system is displayed.

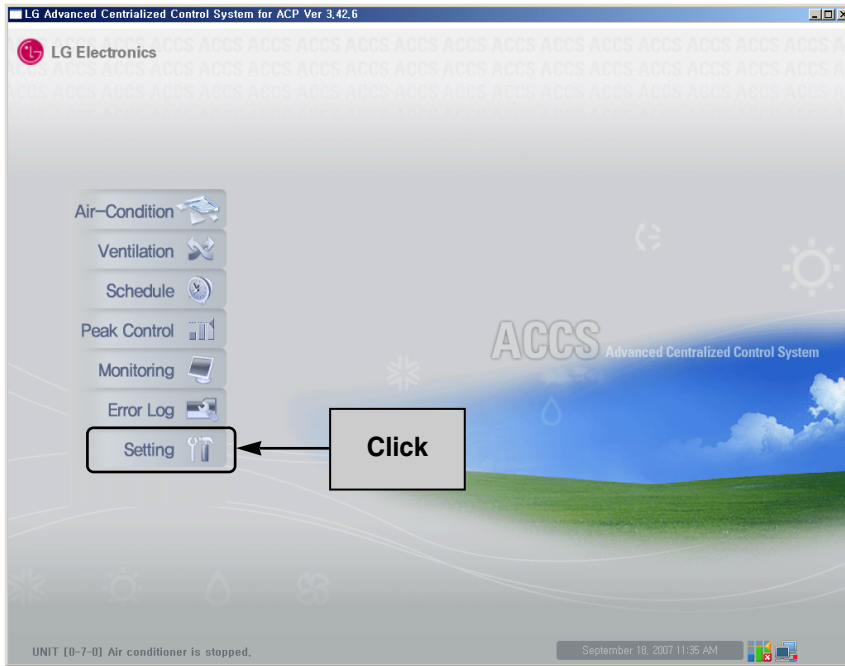

Setting the air conditioner

Set the indoor unit of the air conditioner as follows. The setup method is described by the assumption that 5 indoor units of the air conditioner are connected to each of four groups. Set the group number (indoor unit number) to 0, 1, 2, and 3.

1. Click 'Air conditioner setup' tab at 'System setup' menu of the LG ACCS.

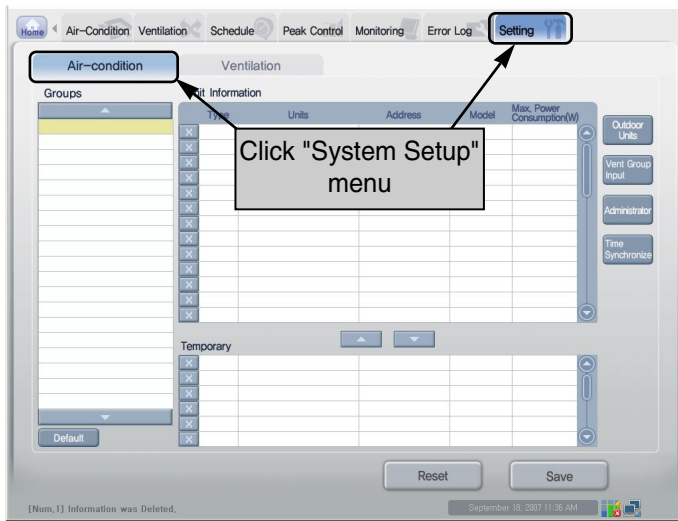

2. In order to set the air conditioner, first of all, enter the outdoor unit information (group number) of the air conditioner. Each outdoor unit information is used as the information of the physical group connecting the indoor unit. Click [Outdoor unit input] at 'System setup' screen of the LG ACCS to display the window for setting the group number.

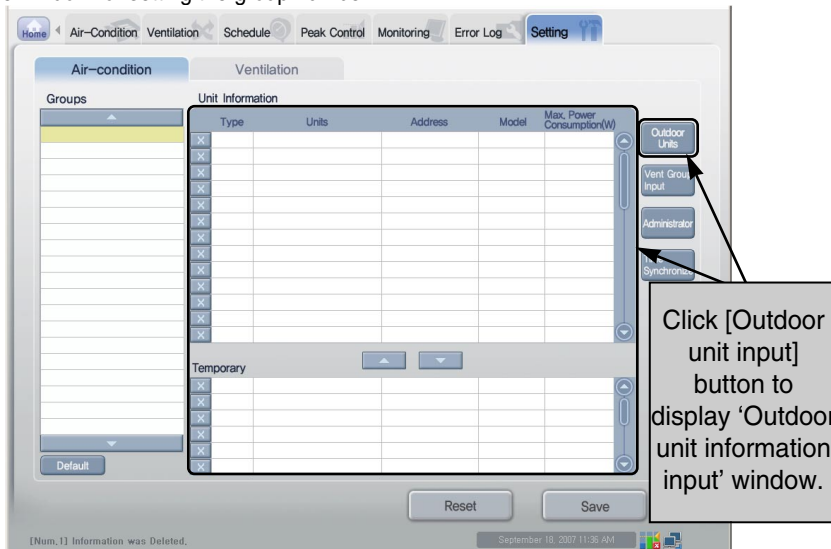

3. Click [Default input] button. The outdoor unit information (group number) is automatically entered.

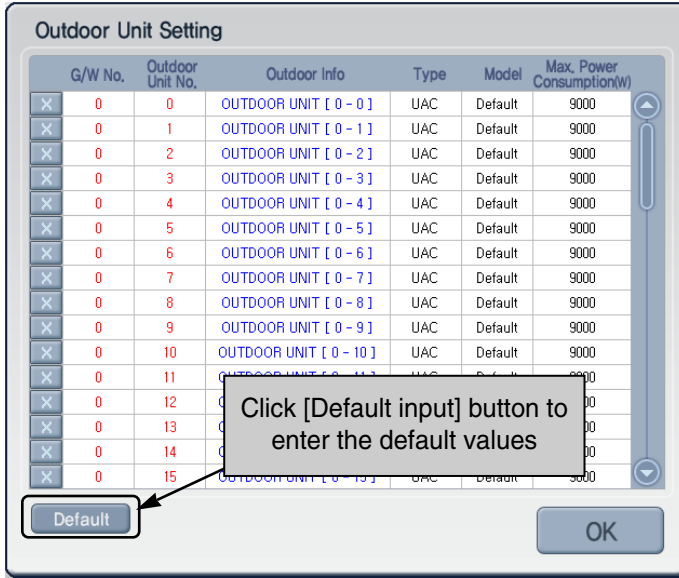

4. Except the outdoor units as many as the number of the outdoor units (the number of groups) to set according to the air conditioner installation plan, delete all remaining outdoor units by pressing button. Here, because we assume that four groups in total are set and the group number is set to 0, 1, 2, and 3, leave only four groups as shown at the below figure.

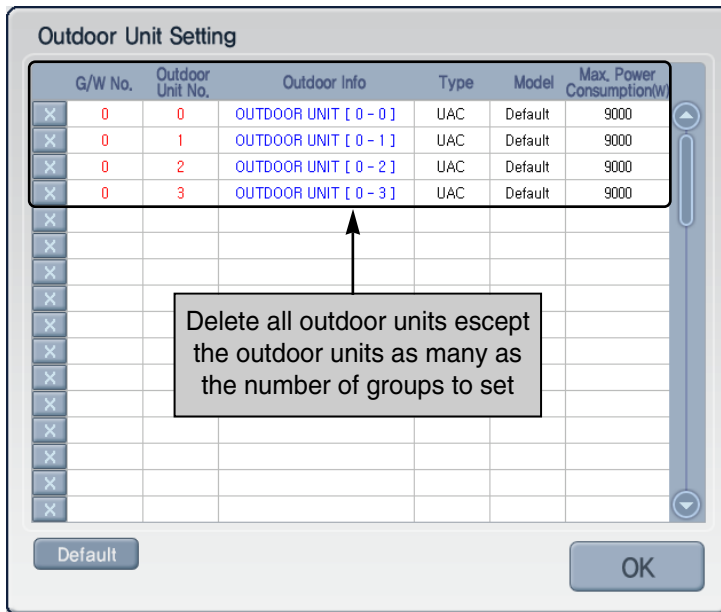

6. When you click [Done] button, 'Outdoor unit information input' window is closed and it returns to the previous screen. Click [Default input] button at 'Air conditioner setup' tab. The groups as many as the number of set outdoor units are automatically created and the information of the air conditioner included at the group is also created.

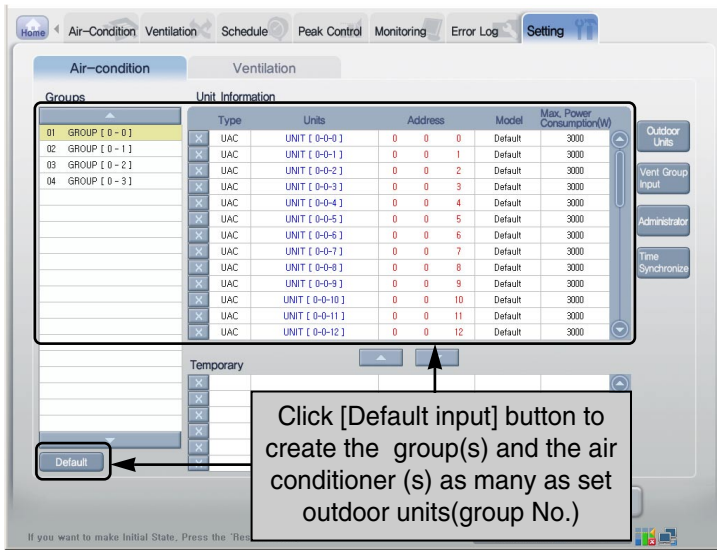

7. Leave the indoor units as many as the number of the air conditioners to set for each group, and delete the remaining indoor units by pressing button. As five indoor units of the air conditioner are connected for each group, all units are deleted except five indoor units information.

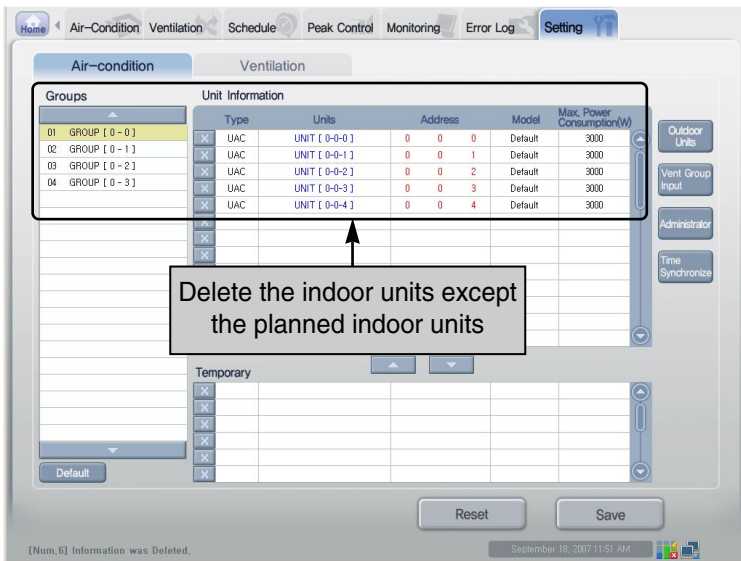

8. Enter the air conditioner group name and the information of the indoor unit. When each displayed item is clicked, its color is changed to yellow for its contents to be directly entered or the list box is displayed. Enter the setting value suitable for each item. See the following table for the description on the setting item.

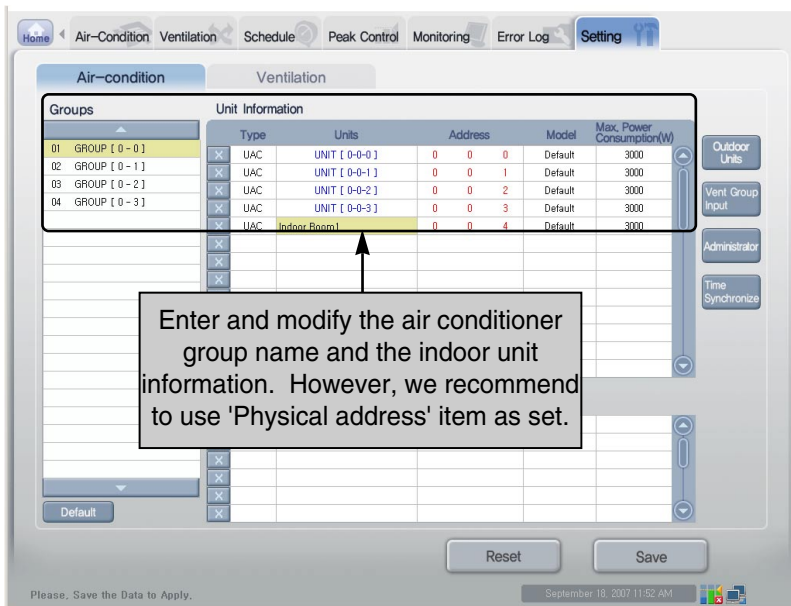

Item	Description
Group name	Enter the air conditioner group name for the user to easily recognize.
Type	<p>Enter the indoor unit type. Indoor types to set are as follows:</p> <ul style="list-style-type: none"> • UAC: Unified air conditioner • SGL: Single type air conditioner <div style="border: 1px solid gray; padding: 5px; background-color: #f0f0f0;"> <p>Caution: Set to UAC type</p> <p> The indoor unit type should be set to UAC (unified air conditioner) type. At present, the SGL (single type air conditioner) type can not be set.</p> </div>
Air conditioner name	Enter the air conditioner name for the user to easily recognize.

Dip switch	Description
Physical address	<p>Enter the physical address of the indoor unit. The physical address consists of three numbers.</p> <p>The first number and the second number are the G/W number and the outdoor unit number respectively, which can be set within the information entered from the existing [G/W information] and [outdoor unit information].</p> <p>The third number is the indoor unit number, which can not be set overlapped within the same indoor unit number and should be set within the range of 0~15.</p> <p>If the user directly enters the physical address, it can be easily entered incorrectly. So, [Default value] button should be used to enter.</p>
Model name	Enter the model name of the indoor unit.
Maximum consumed power	Enter the maximum consumed power for the indoor unit to use. The maximum consumed power depends on the model.

9. For the remaining three groups, set the number of the indoor units and the item by the procedure same to Step 7 and 8.
10. When all items are set, press [Save] button to save. Press [Save] button to display the window to confirm to save the setting information. Press [OK] button to save the setting information.

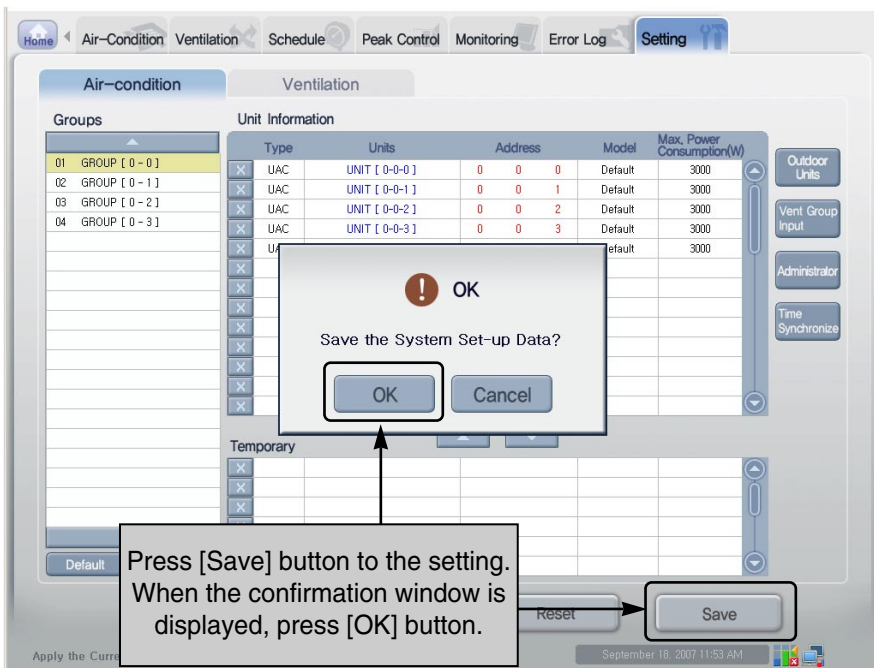

11. The saving process is performed. When the air conditioner setup is successfully done, the group and the air conditioner information set at present can be checked.

The screenshot displays the 'Air-Condition' control interface. At the top, there is a navigation bar with tabs for Home, Air-Condition, Ventilation, Schedule, Peak Control, Monitoring, Error Log, and Setting. Below this is a status bar showing 'GROUP [0 - 7]' and a grid of 16 units with their respective modes and temperatures. A central panel on the left lists 'Groups' and 'Units', with 'GROUP [0 - 7]' and 'UNIT [0-7-0]' selected. The right panel provides detailed controls for the selected unit, including Mode (Cooling, Heating, Dry, Fan, AI), Fan Speed (Low, Medium, High, Auto), Auto Swing (On/Off), Lock (Temp Lock, All Lock), and Set Temp (22°C). A 'Run' button and a 'Stop' button are at the bottom. A callout box with an arrow points to the 'Units' list, stating: 'Possible to check the set group and air conditioner information'.

GROUP [0 - 7]	01	02	03	04	05	06	07	08	09	10	11	12	13	14	15	16
Mode	❄️	❄️	❄️	❄️	❄️	❄️	❄️	❄️	❄️	❄️	💧	❄️	❄️	❄️	❄️	❄️
Temp (°C)	28	28	28	28	28	28	28	28	28	28	28	28	28	28	28	28
Set Temp (°C)	22	23	23	23	24	20	27	23	20	23	--	27	27	26	24	27

Note: Physical and Logical group

At the ACP, the connected air conditioners can be grouped by using the concept “Physical group” and “Logical group.”

The physical group is the outdoor unit physically connecting the indoor unit. The example of the physical group is setting the address to the indoor unit at the installation step. However, the logical group is used for the convenient control regardless to the physical connection.

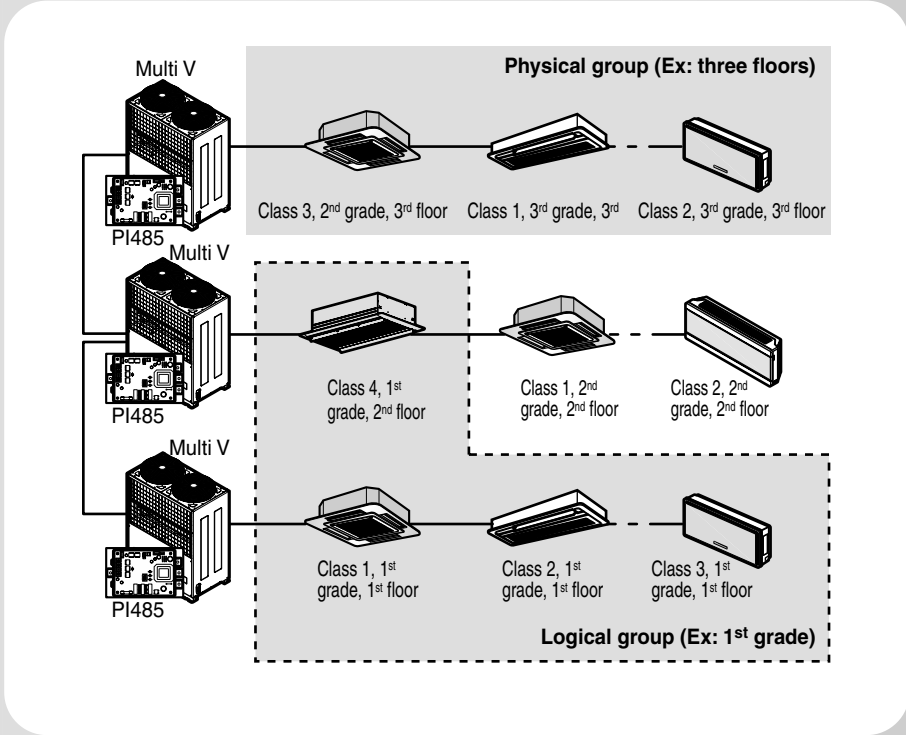

For describing the difference between the physical group and the logical group by the example of the school, as shown at the above figure, the logical group can be said the set of the air conditioners connected to the same outdoor unit. However, the logical group can be configured even when the air conditioners at the 1st grade classrooms are connected to the different outdoor units regardless to the physical connection.

Setting the ventilator

Set the ventilator as follows. In this case, the method for setting the ventilator is described by the assumption that five ventilators are connected to two groups (Group number 0 and 1) respectively.

1. Click 'Ventilating setup' tab at 'System setup' menu of the LG ACCS.

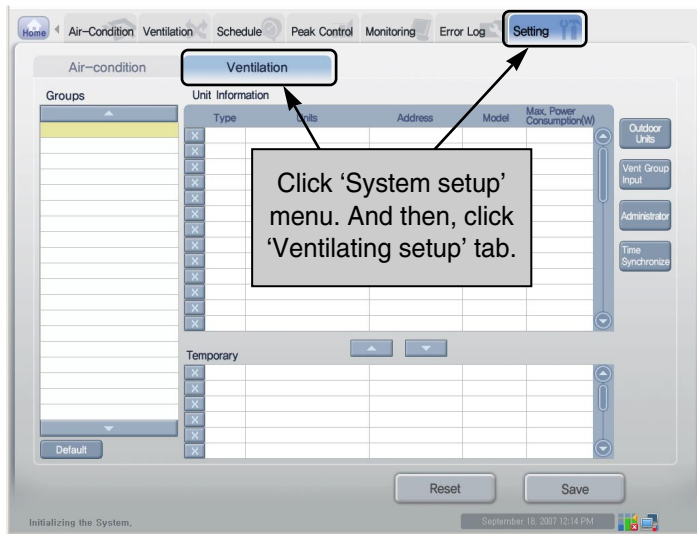

2. To set up the ventilator, you must first enter the group number of the ventilator. The information of each outdoor unit is used as the physical group information connecting the ventilator. When you click on [Enter ventilator group] button in the 'System setting' screen of LG ACCS, the window to set the group number is displayed.

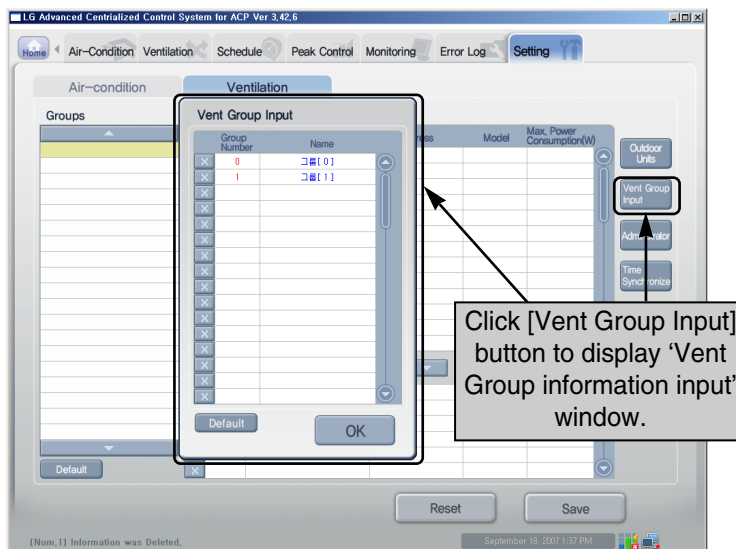

3. Click [Default input] button. The group number (outdoor unit number) is automatically entered.

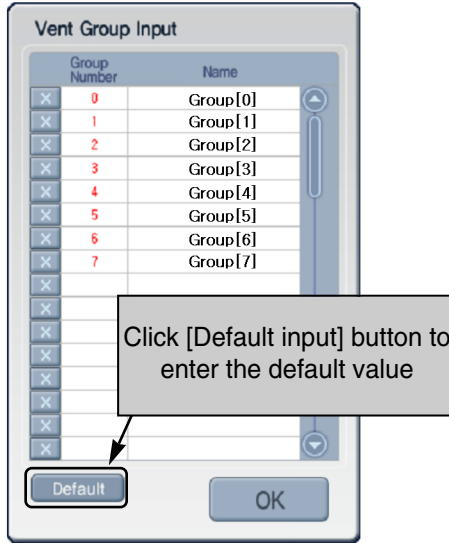

4. Leave the item(s) as many as the number of groups to set according to the installation plan of the ventilator, and press button to delete all remaining outdoor units. Here, because two groups (group number 0 and 1) are assumed to be set in total, leave only two groups as shown at the below figure.

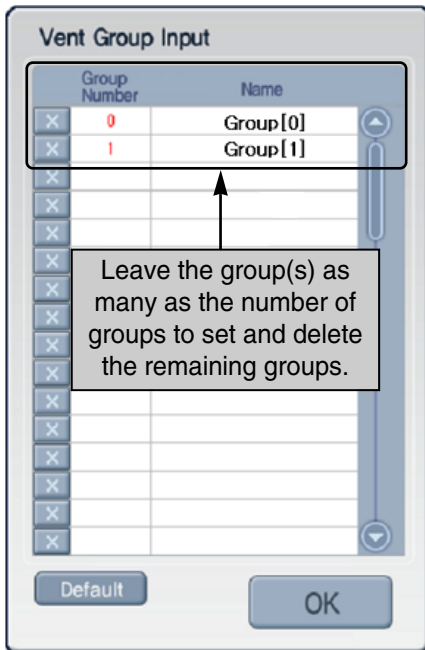

5. Enter the setting value suitable to each item. When the item to be set is clicked, the related item is changed to yellow and its setting value can be modified. See the below table for the description on the item to set.

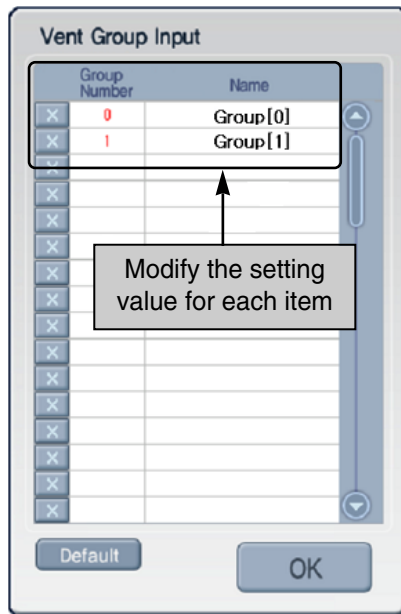

Item	Description
Group number	Enter the number to classify the ventilator group. When the number is entered through the [Input default value] button, it is good to keep the number as it is.
Name	Do not set up the name and keep the default value.

6. When [Done] button is clicked, 'Outdoor unit information input' window is closed and it returns to the previous screen. Click [Default input] button at 'Ventilating setup' tab. The group(s) are automatically created as many as the number of the set outdoor units, and the information about the ventilator included at the group is created.

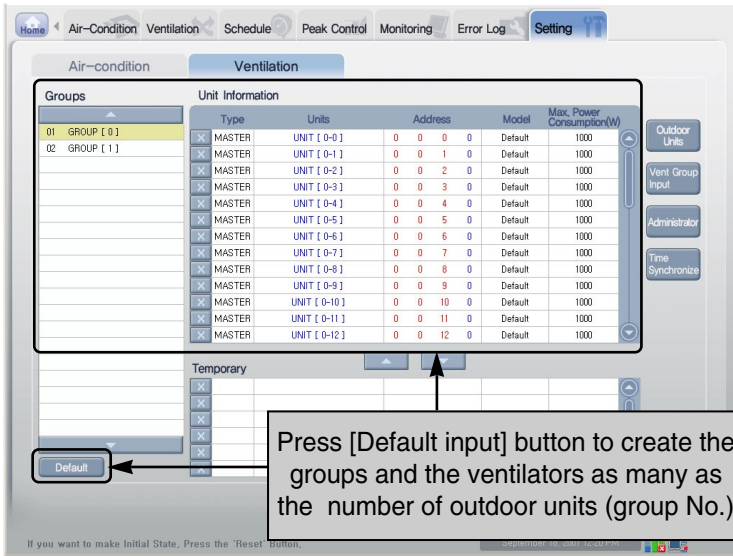

7. Leave the item(s) as many as the number of ventilators to set for each group, and press button to delete all remaining ventilators. Here, because five ventilators are assumed to be connected to each group, only five ventilator information is left and all remaining ones are deleted.

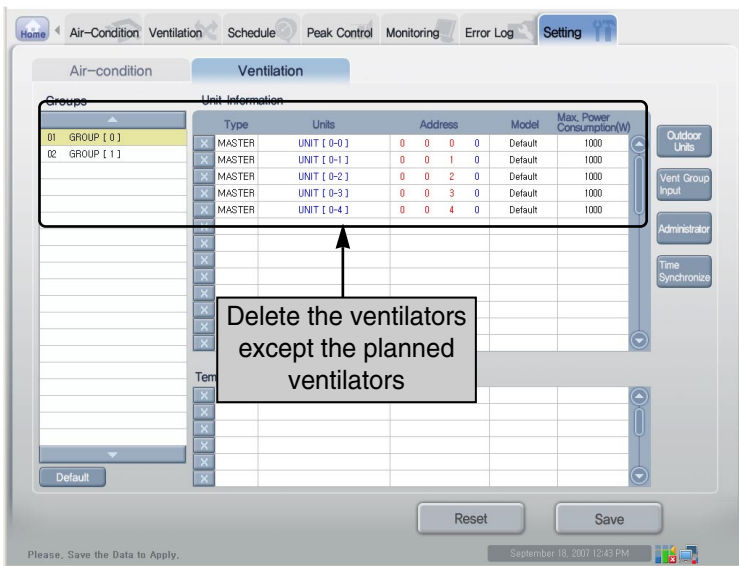

8. Enter the ventilator group name and the information of the ventilator. When each displayed item is clicked, it's color is changed to yellow for its contents to be directly entered or the list box is displayed. Enter the setting value suitable for each item. See the following table for the description on the setting item.

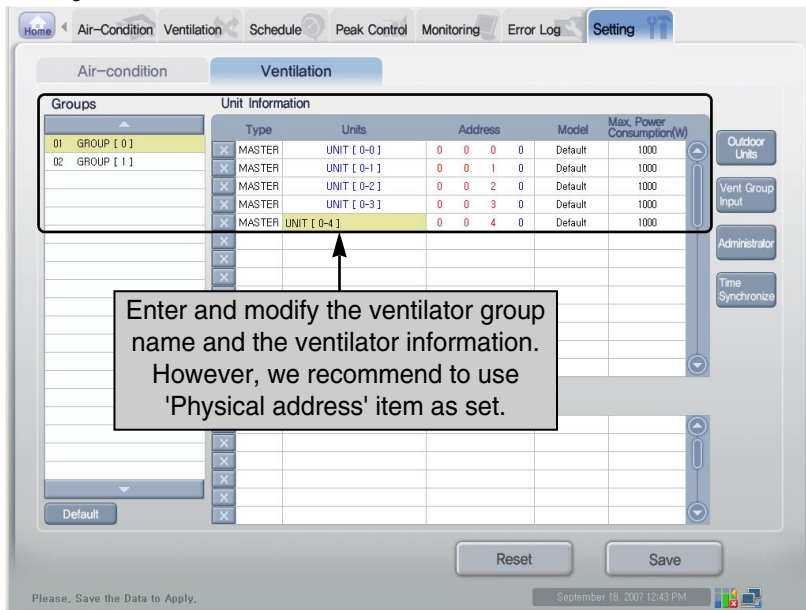

Item	Description
Group name	Enter the ventilator group name for the user to easily recognize.
Type	Leave this information as it is without changing.
Ventilator name	Enter the ventilator name for the user to easily recognize.
Physical address	Enter the physical address of the ventilator. When [Default input] button is pressed, it is automatically created by inheriting the higher information. Physical address is composed of 4 numbers. The first and second number is the G/W number and ventilator group number, respectively. This can be set only within the entered information from existing [G/W information] and [Ventilator group input] menu. The third number is the ventilator number, which cannot be duplicated within the same ventilator group number and must be set within the range of 0~15. The fourth number is the Master and Slave setting. This value is set to 0 (Master) and must not be changed.
Model name	Enter the model name of the ventilator.
Maximum consumed power	Enter the maximum consumed power for the ventilator to use. The maximum consumed power depends on the model.

9. For the remaining one group, set the number of the ventilators and the item by the procedure same to Step 7 and 8.
10. When all items are set, press [Save] button to save. Press [Save] button to display the window to confirm to save the setting information. Press [OK] button to save the setting information.

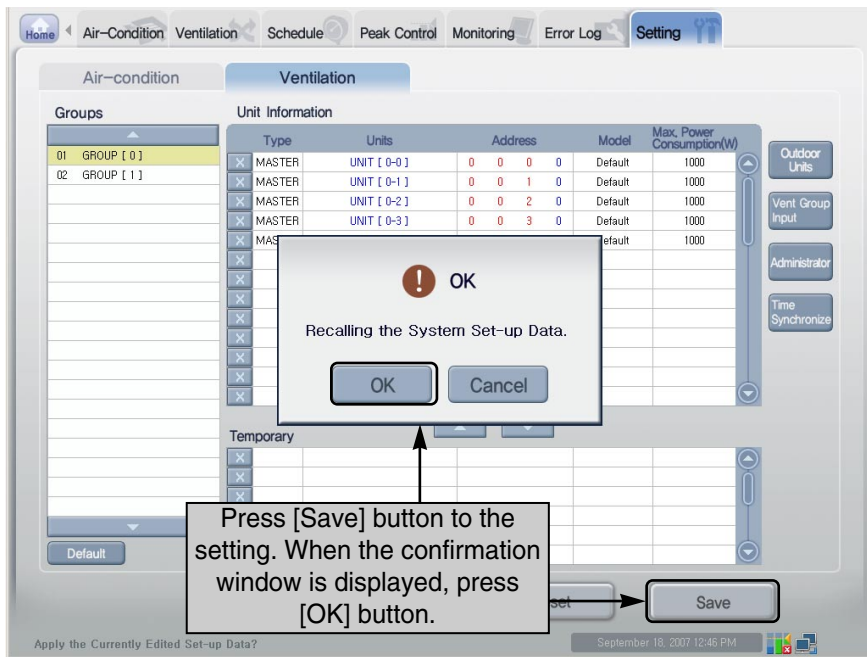

11. The saving process is performed. When the ventilator setup is successfully done, the group and the ventilator information set at present can be checked at the 'Ventilating' menu.

Making sure and checking the ACP installation

After installing the ACP, the condition of the ACP can be checked by the following flow chart.

Checking whether the indoor unit of the air conditioner is connected or not

First, it should be checked whether the indoor unit of the air conditioner is connected or not by executing the LG ACCS of the ACP. Check the condition of the ACP by the following flow chart.

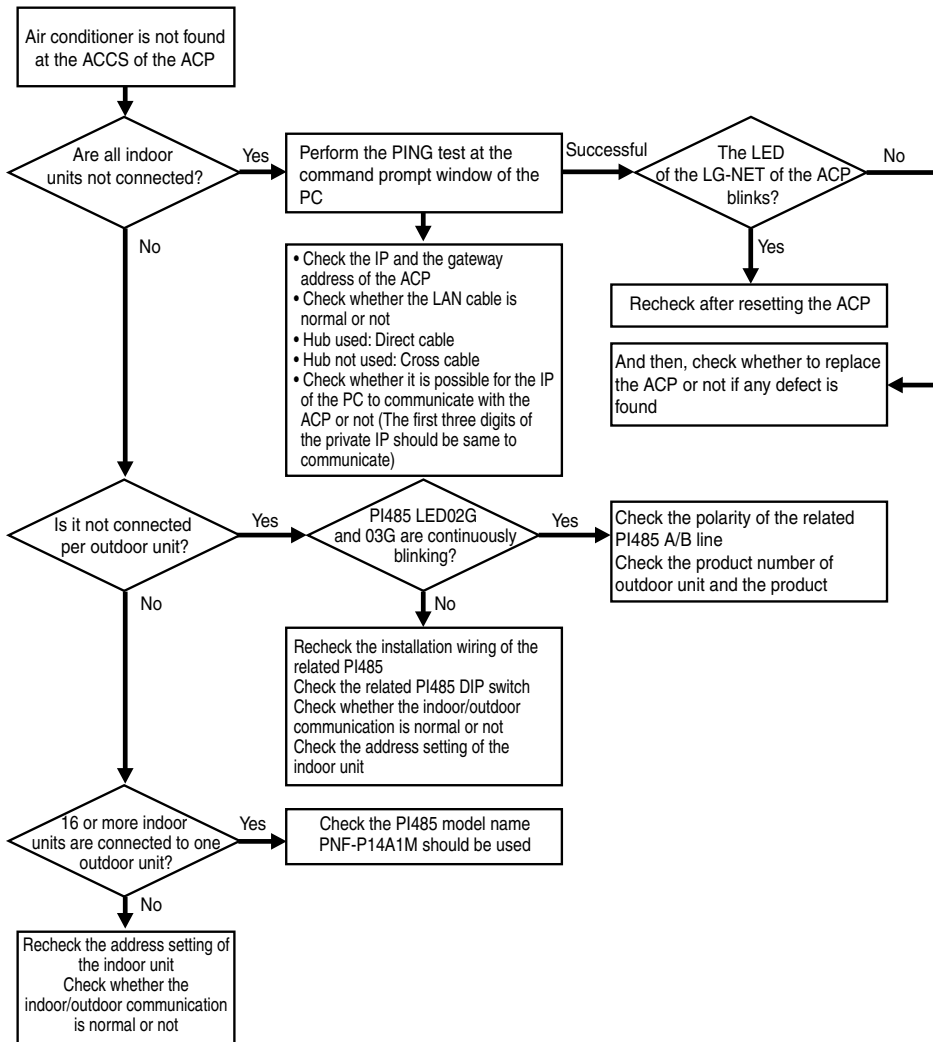

Monitoring the ACP condition after the lock all and the temperature lock

Execute the LG ACCS of the ACP to select all indoor units and execute the lock all function. And then, after performing the temperature lock function again, monitor the ACP condition. Check the ACP condition according to the following flow chart.

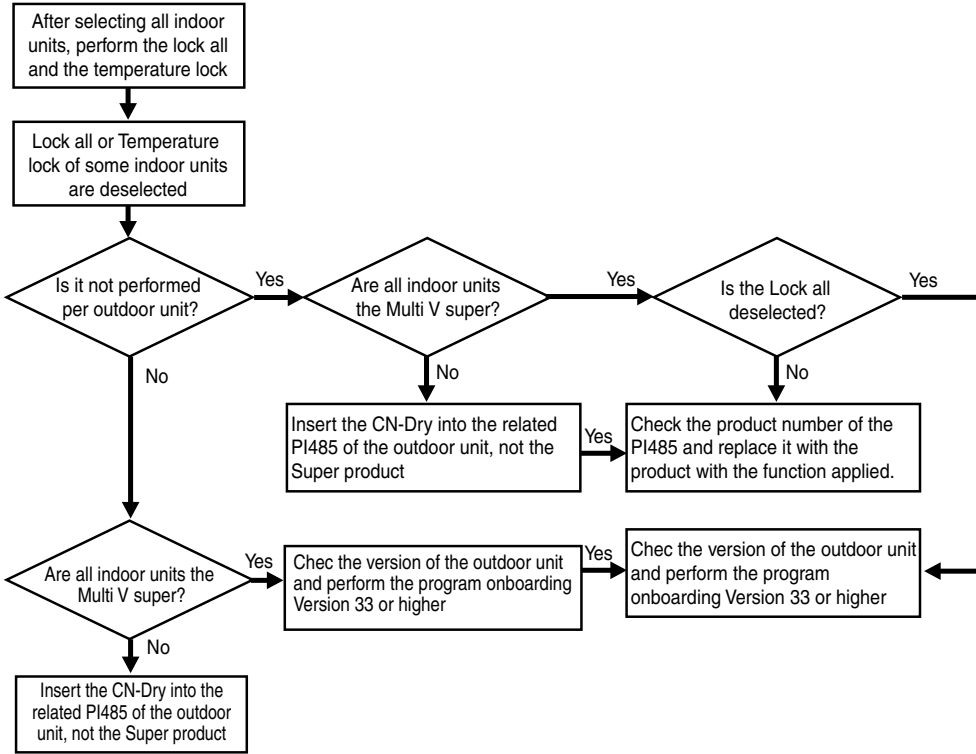

3. ACP operation by using the LG ACCS

The LG ACCS is the UI program of the web server which can operate the ACP. This chapter describes the function and the procedure to use the LG ACCS for operating the ACP.

Accessing the ACCS

In order to enter the indoor unit information by using the LG ACCS program of the ACP, first of all, the LG ACCS should be accessed.

In order to access the LG ACCS, perform the following procedure at the PC connecting the internal network where can be connected to the ACP.

1. Execute the Internet Explorer at the PC connecting the ACP via the Internet or the internal network. And, enter the IP address set to the ACP into the address window, and press [Enter] key.

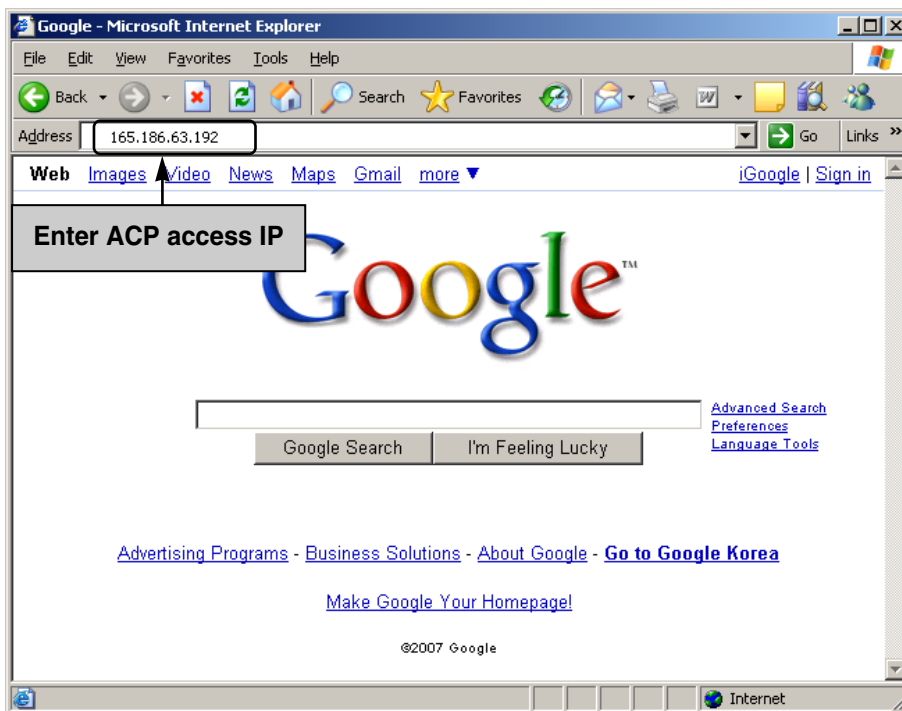

Note: ACP access IP

If the access IP of the ACP is not known, check the ACP setup IP by referring to 'Chapter 2. Configuring the ACP network – Checking the network environment setting.'

2. When the IP address is correctly entered, the following LG ACCS Login screen is displayed. Enter the ID and the password and then click [Login] button.
Set the ID to 'admin' and the password to 'digital21' for the first access to the ACP.

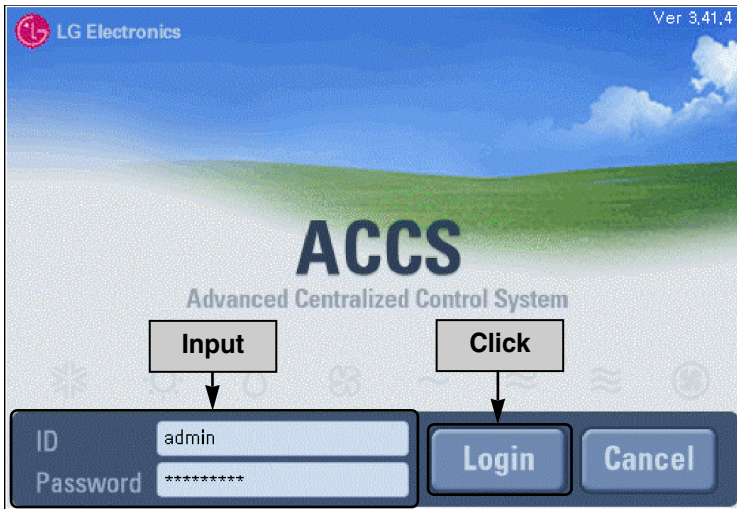

3. When the login is successfully done, the following access procedure will be executed.

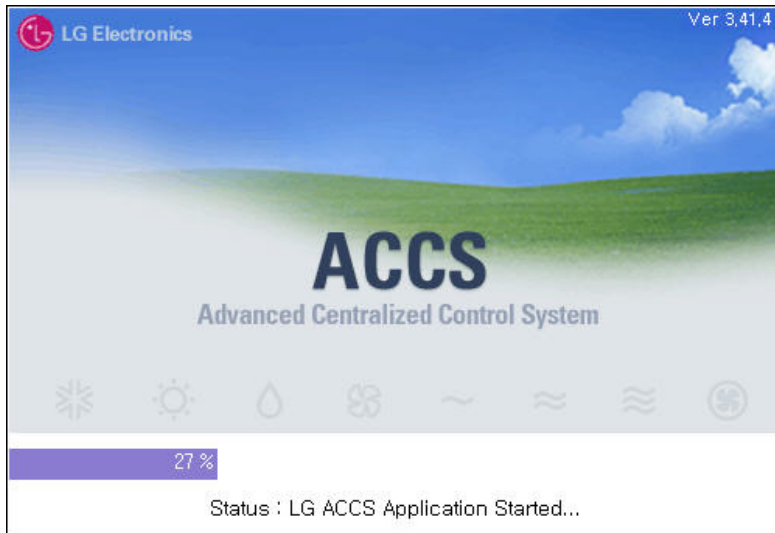

4. The initial screen of the LG ACCS is displayed as shown at the below. When you click the button of the function to control, the screen is changed to use the related function.

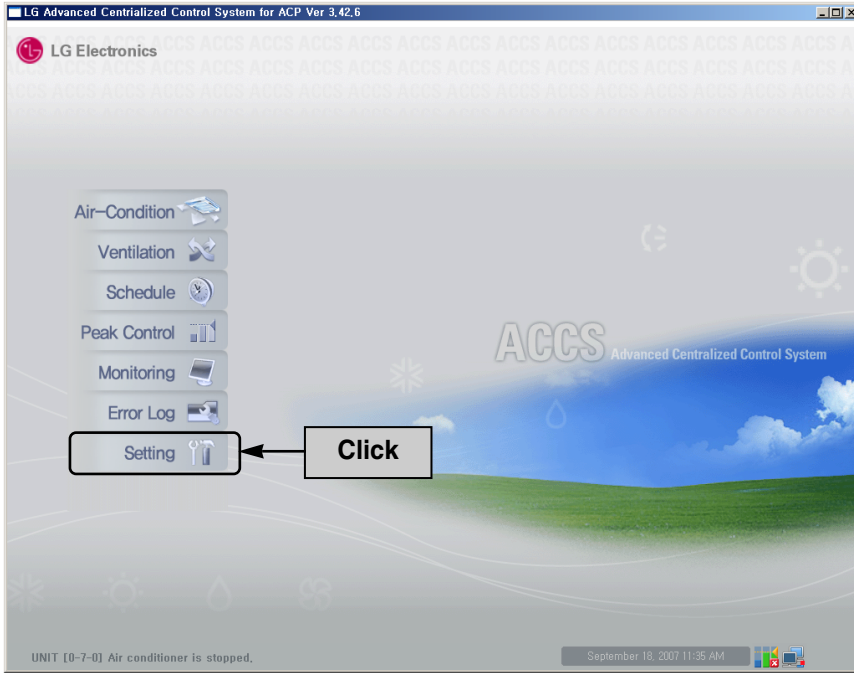

Reviewing the initial ACCS screen





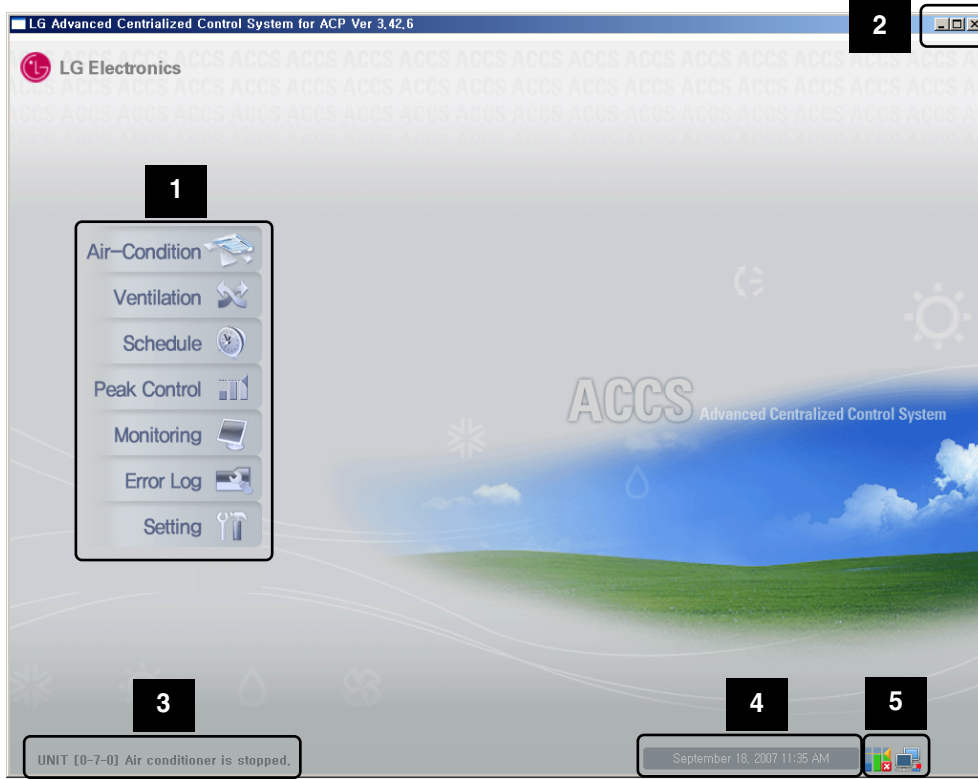



The LG ACCS(Advanced Centralized Control System) is the program which is automatically executed when accessing the ACP web server. The user can control the indoor unit and the ventilator of the air conditioner connected to the ACP and monitor various status information by using the LG ACCS.

When accessing the AG ACCS, the following LG ACCS program will be executed.

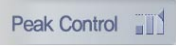

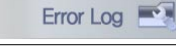

1 Menu selection buttons

You can select the menu at the menu selection button to perform the functions such as controlling and monitoring. The ACP consists of the following eight menus.

Item	Description
 Air-Condition	Air conditioner / Perform the operation change, the Lock all, and the temperature lock of the air conditioner connected to the ACP.
 Ventilation	Ventilating / Perform the operation change and the Lock all of the ventilator connected to the ACP.
 Schedule	Schedule / Start and stop the indoor unit of the air conditioner connected to the ACP according to the reserved schedule.
 Peak Control	Peak power / Set the peak operation ratio by setting the operation ratio of the whole air conditioner for the operation ratio of the air conditioner not to exceed the setting value. If this function is set to the ACP, the demand power control function can not be used simultaneously.
 Demand Control	Demand / Set the demand power control function by monitoring the whole power of the indoor unit of the air conditioner at real time not to exceed the target power. If this function is set to the ACP, the peak operation ratio control function can not be used simultaneously.
 Monitoring	Monitoring / Monitor the operation and error status of all air conditioners connected to the ACP.
 Error Log	Error history / View the history of the errors occurred at the air conditioner connected to the ACP.
 Wattmeter	Wattage / Wattage consumed at the air conditioner connected to the ACP.
 Setting	System setup / Register, change, or delete the information about the air conditioner and the ventilator connected to the ACP.

2 LG ACCS window buttons

You can exit or minimize the LG ACCS window.

Item	Description
	Minimize the LG ACCS window to be displayed at the task bar at the bottom only.
	Not used.
	Exit the LG ACCS setup and the LG ACCS window.

3 Message window







It displays the message about the operation information and the error information of the indoor unit of the air conditioner.

4 Current time window

It displays the current time (year, month, day, day of the week, time).

5 Peak operation ratio control & Network status window

It displays the execution status of the peak operation ratio control mode and the air status of the network as icon.

Item	Icon	Description
Peak operation ratio		Displayed when the peak operation ratio control mode is being executed
		Displayed when the peak operation ratio control mode is being stopped
		No icon displayed when the peak operation ratio control is not installed
Network connection status		Displayed when the error is occurred at the network connection.
		Displayed when the network is successfully connected and being normally operated.
		Displayed when trying to connect the network.

Controlling the air conditioner

You can use the LG ACCS to control the functions such as selecting the air conditioner group or the air conditioner, the operation mode, the air flow, the air direction, the lock, the temperature control, and the stop.

The air conditioner control function has the following advantages:

- Manage all installed air conditioners by using the computer screen with the central control method.
- Easily operate and monitor.
- Perform the integrated management by the group setup.

Click 'Air conditioner' menu at the top of the LG ACCS to control the air conditioner. Click 'Air conditioner' menu to display the air conditioner control screen as shown at the below.

1 Air conditioner operation status window

It displays the operation status of each air conditioner, the operation mode, the temperature of the space with the indoor unit installed, and the desired temperature.

Group name & Operation status lamp



The name of the selected group and the status of each air conditioner belonging to the group are displayed at the top of the air conditioner operation status window.

The operation status of up to 16 air conditioners is displayed at one screen. If there are more than 16 air conditioners installed, press or to check the status of the other air conditioners.

The color of the lamp displays the status of the air conditioner. The color displays the air conditioner status as follows:





Lamp color	Status	Description
(green)	On	The current air conditioner normally operates.
(red)	Blinking	The current air conditioner has the error occurred.
(grey)	On	The current air conditioner stopped.
(yellow)	On	The current air conditioner is under the peak operation ratio control status.

Operation mode



At the operation mode, if the air conditioner is currently operating, the operation mode is displayed as icon.

Item	Icon	Description
Normal operation		The current air conditioner performs the cold operation.
		The current air conditioner performs the dehumidification operation.
		The current air conditioner performs the ventilation operation.
		The current air conditioner performs the heating operation.

Item	Icon	Description
Normal operation		The current air conditioner is at the peak operation ratio control status.
		The current air conditioner performs the artificial intelligent operation. The artificial intelligent operation is the automatic operation for the air conditioner by itself to set and operate the operation mode and the air flow of the air conditioner according to the room temperature.
Error status		The current air conditioner has the error occurred.
		The error caused by the network is occurred.

Current & desired temperature

Temp (°C)	28	28	28	28
Set Temp (°C)	22	23	23	23

The temperature of the space where the air conditioner is installed is displayed at the current temperature. However, if the error lamp is turned ON, the number of the current temperature does not display the temperature, but the error code.

The desired temperature set at the air conditioner is displayed at the desired temperature. The desired temperature is not displayed if the air conditioner performs the ventilation or the dehumidification operation or at the error condition.

2 Selecting the air conditioner group or the air conditioner window

This window displays the list of the air conditioner group or the air conditioner set at the system. Also, the air group and the air conditioner for controlling the air conditioner can be selected.

Select/Deselect All button



[Select All] button and [Deselect All] button are located at 'Group' list and 'Air conditioner' list. It is convenient to select or

deselect all air conditioner groups or air conditioners at the list. However, the air conditioner group and the air conditioner located at the top of the list are selected as default.

Air conditioner group list & Air conditioner list

Groups	Units
01 GROUP [0 - 0]	01 UNIT [0-7-0]
02 GROUP [0 - 1]	02 UNIT [0-7-1]
03 GROUP [0 - 2]	03 UNIT [0-7-2]
04 GROUP [0 - 3]	04 UNIT [0-7-3]
05 GROUP [0 - 7]	05 UNIT [0-7-4]
	06 UNIT [0-7-5]
	07 UNIT [0-7-6]
	08 UNIT [0-7-7]
	09 UNIT [0-7-8]
	10 UNIT [0-7-9]
	11 UNIT [0-7-10]
	12 UNIT [0-7-11]
	13 UNIT [0-7-12]
	14 UNIT [0-7-13]
	15 UNIT [0-7-14]
	16 UNIT [0-7-15]

The list of the air conditioner group set at the ACP is displayed at 'Group.' When a specific air conditioner group is selected from the air conditioner group list, the list of the air conditioners belonging to the related air conditioner group is displayed at 'Air conditioner' located at the right side.

When the air conditioner group to select is clicked at the list, the related group is selected, and when it is again clicked, the selection of the related group is deselected. Also, more than one group can be selected by clicking more than one air conditioner group.

'Air conditioner' displays the list of the air conditioners belonging to a specific air conditioner group of the ACP.





When you click the air conditioner to select at the list, the related air conditioner is selected, and when you click it again, the related air conditioner is deselected. Also, you can select more than one air conditioner by clicking more than one air conditioner.

3 Controlling & monitoring the air conditioner window

It displays the air conditioner control setting selected from the list of the air conditioner group and the air conditioner list to control.



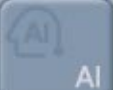

Operation mode

The operation method of the air conditioner can be set at the operation mode. The operation modes to set are as follows:

Item	Description
	<p>It operates the cold operation. The cold operation can set the desired temperature to 18°C ~ 30°C</p> <p>Note: Setting the desired temperature Because too much cooling is harmful for health, set the suitable desired temperature. About 5°C is better for the difference between the indoor temperature and the outdoor temperature. If the desired temperature is higher than the indoor temperature during the cold operation, it does not operate the cold operation, but the ventilation.</p>
	<p>It drives the heating operation. The heating operation can set the desired temperature to 18°C ~ 30°C</p> <p>Note: Setting the desired temperature The excessive heating is harmful for the health, so set the suitable desired temperature. About 5°C is better for the difference between the indoor temperature and the outdoor temperature. If the desired temperature is lower than the indoor temperature during the heating operation, it does not operate the heating operation, but the ventilation.</p>
	<p>The dehumidification eliminates moisture. It can effectively eliminate moisture during the rainy season or at the high humidity condition. When it is selected, the desired temperature can not be set.</p>
	<p>It circulates the fresh air. The ventilation only may be used in Spring and Autumn. When it is selected, the desired temperature can not be set.</p>
	<p>It evaluates the indoor condition and maintains the optimal condition automatically.</p>



Air flow

It controls the air flow. The types of air flow to set are as follows:

Air flow	Description
	It sets to ventilate with a small of air flow.
	It sets to ventilate at the medium level of air flow.
	It sets to ventilate at the high level of air flow.
	It sets to automatically ventilate at the suitable level of air flow for the environment with the indoor unit installed.





Air direction

It sets the air direction of the current air conditioner to Up & down or Left & right.



Icon	Description
	It executes the air direction operation of the air conditioner.
	It stops the air direction operation of the air conditioner.

Lock

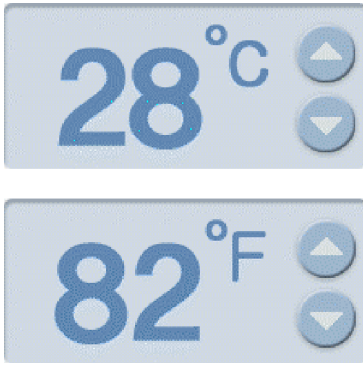

It sets the lock function of the air conditioner. When the lock function is set, the air conditioner can not be controlled by the wireless or wired remote controller. Use the lock function not for the user individually, but to centrally control the air conditioner

Type	Icon	Description
Temperature lock		Control not to set the temperature by using the wireless or wired remote controller.
		Set the temperature lock.
		Deselect the set temperature lock.
Lock all		Control not to set the entire function of the air conditioner by using the wireless or wired remote controller.
		Set the Lock All function for the entire air conditioner.
		Deselect the set Lock All function.

Desired temperature



Set the desired indoor temperature of the air conditioner. The desired temperature can be set by clicking  or .

The desired temperature can be set for both the cooling and the heating with the range of 18°C~30°C.

Click  to switch to  for displaying the temperature. The desired temperature can be set in Fahrenheit with the range of 64°F~86°F.

Starting & Stopping the operation

Click 'Start' or 'Stop' button to start or stop the air conditioner.

Icon	Description
	Operate the air conditioner according to the set value.
	Stop the operating air conditioner.

Note: Changing the control setting

After selecting more than one air conditioner with different control condition, when the control setting of the air conditioner is changed, it is applied to all of the currently operating air conditioners with the same setting. But, it is not applied to the stopped air conditioner even when the control setting is changed. However, for the case of the lock function, it is applied to the stopped air conditioner.

Note: When using each lock function at the Multi model

When using each lock function at the indoor unit (wall mounted, ART COOL, ART COOL Mirror) model of the Multi model, use the temperature lock, the mode lock and the airflow lock at a time.

Controlling the ventilator

You can use the LG ACCS to control the functions such as selecting the ventilating group and the ventilator, the operation mode, the air flow, the additional function and the lock.

The ventilation control function has the following advantages:

- It can centrally control all the installed ventilators by the computer screen.
- It can easily operate and monitor.
- It can perform the integrated control by the group setting.

Click 'Ventilating' menu at the top of the LG ACCS for controlling the ventilator. Click 'Ventilating' menu to display the following screen for controlling the ventilator.

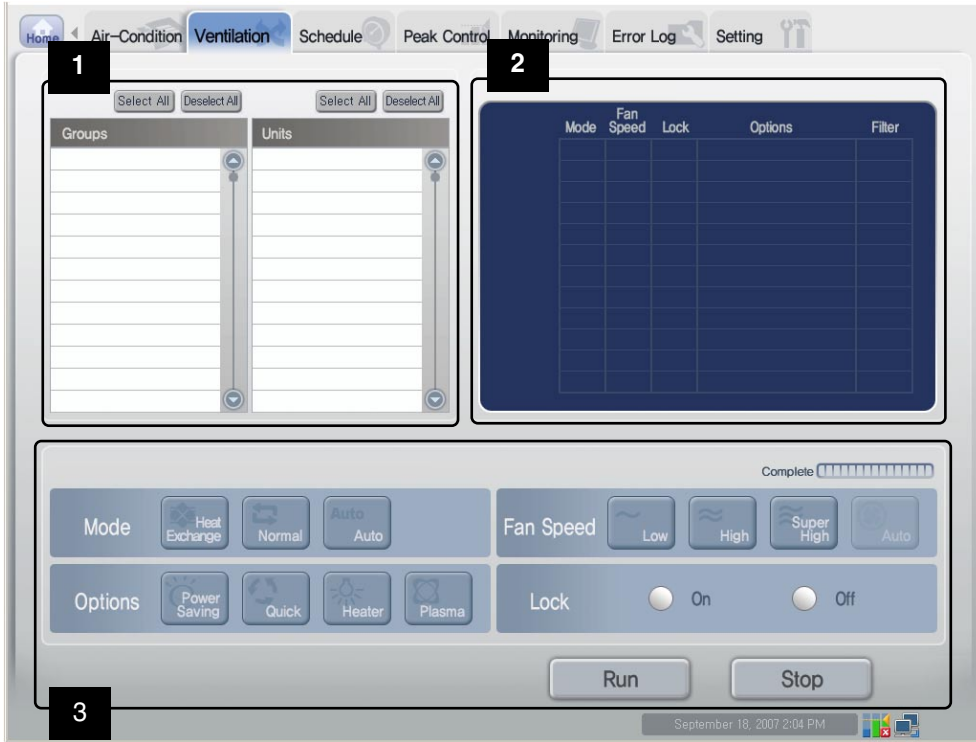

1 Select Ventilating group & Ventilator window

The list for the ventilating group and the ventilator set at the system is displayed on this window. Also, the ventilating group and the ventilator can be selected for controlling the ventilator.

Select & Deselect All button



These buttons are located at 'Group' list and 'Ventilating' list. It is convenient to select or deselect all of the ventilating groups or

ventilators from the list. However, the ventilating group and the ventilator located at the top of the list are not deselected, because they are selected as default.

Air conditioner group list and Air conditioner list

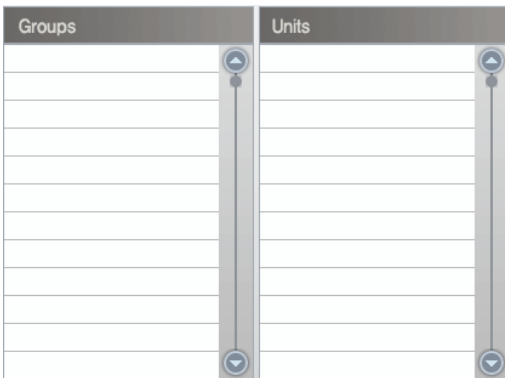

The list of the ventilating group set at the ACP is displayed at 'Group.' When you select a specific ventilating group from the ventilating group list, the list of the ventilator(s) belonging to the related ventilating group is displayed at 'Ventilator' located at the right side.

When you click the ventilating group to select from the list, the related group is selected, and when you click it again, the related group is deselected. Also, more than one group can be selected together by

clicking them. The list of the ventilator(s) belonging to a specific ventilating group of the ACP is displayed at 'Ventilating.'

When you click the ventilator to select from the list, the related ventilator is selected, and when you click it again, the related ventilator is deselected. Also, more than one ventilator can be selected together by clicking them.

2 Ventilator operation status window

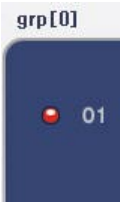

This window displays the information such as operation mode of each ventilator, air direction, lock feature and additional function.

Group name & Operation status lamp







The screenshot shows a dark blue rectangular area. At the top left, the text 'grp[0]' is displayed. Below it, a red circular lamp icon is shown next to the number '01'.

The name of the selected ventilating group and the status of each ventilator belonging to the group are displayed with the lamp at the left side of the ventilator operation status window.

The operation status of up to 12 ventilators is displayed on one screen. When more than 12 ventilators are set, the status of the other ventilators can be checked by pressing  or .

The color of the lamp displays the status of the ventilator. The color displays the ventilator status as follows:

Lamp color	Status	Description
 (green)	On	The current ventilator normally operates.
 (red)	Blinking	The current ventilator has the error occurred.
 (grey)	On	The current ventilator stopped.
 (yellow)	On	The current ventilator is under the peak operation ratio control status.
	Blinking	The current ventilator is sending data.



Operation mode



The screenshot shows a dark blue rectangular area with the word 'Mode' written in white.





At the operation mode, if the ventilator is currently operating, the operation mode is displayed as icon.

The following operation modes are displayed on the screen.

Icon	Description
	Operation at the electric heat mode.
	Operation at the normal mode.
	Operation at the automatic mode.



Air flow**Fan Speed**

The air flow from the ventilator is displayed with the icon.
The air flow icons displayed on the screen are as follows:

Icon	Description
	Weak air flow.
	Strong air flow.
	Air flow at maximum.
	Automatic air flow according to the indoor environment.

Lock**Lock**





The Lock function of the ventilator can be set not by the user individually but by centrally. The icon displays whether the lock function is set or not. The lock icons displayed on the screen are as follows:

Icon	Description
	Weak air flow.
	Strong air flow.

Additional functions**Options**

Various additional functions can be set to the ventilator. The icon displays whether the additional function is set or not.

The additional icons displayed on the screen are as follows:

Icon	Description
	Power saving in operation.
	Quick function in operation.
	Heater function in operation.
	Plasma function in operation.

Note: Additional function

It may not be performed depending on the product.

Filter



The Lock function of the ventilator can be set not by the user individually but by centrally. The icon displays whether the lock function is set or not. The lock icons displayed on the screen are as follows:

Icon	Description
	It displays when it's time to clean the filter. When this icon is displayed, the filter should be cleaned.

3 Controlling & Monitoring the ventilator window



This window displays the information such as operation mode of each ventilator, air direction, lock feature and additional function.



It displays the control setting of the ventilator selected from the ventilating group list and the ventilator list, which can be controlled.





Operation mode

It can set the operation mode of the ventilator. The operation modes to set are as follows:

Mode	Description
	Set both the air supply and the exhaust to be ventilated via the electric heat exchanger. It is used in Summer and Winter with much difference of temperature and humidity between the indoor and the outdoor.
	Set the exhausting air to be ventilated not via the electric heat exchanger. It is used in Spring and Autumn with litt difference of temperature and humidity between the indoor and the outdoor.
	Set to automatically maintain the indoor temperature and the outdoor temperature at the optimum condition by measuring them. The indoor air balance can be constantly maintained by automatically controlling the exhaust and the air supply.





Air flow

It controls the air flow. The types of air flow to set are as follows:

Air flow	Description
	It sets to ventilate with a small of air flow.
	It sets to ventilate at the high level of air flow.
	It sets to ventilate at the highest level of air flow.
	It sets to automatically ventilate at the suitable level of air flow for the environment with the indoor unit installed.

Additional functions

Various additional functions can be set to the ventilator. The types of additional functions to set are as follows:



Icon	Description
	It performs the power saving function. It finds out the best efficiency of the ventilator and operates it to save the consumed power.
	It performs the quick ventilation. It prevents the polluted air or moisture of the indoor from being dispersed to other rooms.
	It performs the heater function. It heats the air in Winter.
	It is the air cleaning function supplying anion to refresh. It treats virus or fungus as well as influenza (representative cold virus) in the room by considering the health as well as the environment.

Note: Additional function

It may not be performed depending on the product.



Lock

It sets the lock function of the ventilator. When the lock function is set, the ventilator can not be controlled by the wireless or wired remote controller. Use the lock function not for the user individually, but to centrally control the ventilator.

Icon	Description
	Set the ventilator lock.
	Deselect the ventilator lock.

Starting & Stopping the operation

Click 'Start' or 'Stop' button to start or stop the selected ventilator.

Button	Description
	Operate the ventilator according to the set value.
	Stop the operating ventilator.

Note: Changing the control setting



After selecting more than one ventilator with different control condition, when the control setting of the ventilator is changed, it is applied to all of the currently operating ventilators

with the same setting. But, it is not applied to the stopped ventilator even when the control setting is changed. However, for the case of the lock function, it is applied to the stopped ventilator.

Setting the schedule

It is the function to perform the reserved operation at the specified time by specifying the operation of the air conditioner. For example, for the case of the school, the air conditioner automatically starts and stops at the specified time by setting the schedule to attending school and returning home.

The unnecessary operation and management cost of the air conditioner can be reduced by this schedule function, and it can effectively save the energy because it is used only when necessary.

Note: Saving after the system setup



Be careful to change the system information at 'System setup' menu and save it because it initializes all schedule information.

Reference: Schedule maintenance time

When setting the schedule, 1~3 minute schedule setting is maintained for time the actual schedule is set.

For example, when you set the schedule for the unit to be turned off at 5:00, the operation is turned off from 5:00 to 5:03. Therefore even when you try to operate the unit with the wired remote controller, it may be turned off.

Reviewing the schedule setup screen

Click 'Schedule' menu at the top of the LG ACCS for setting the schedule. Click 'Schedule' menu to display the schedule setup screen as follows:

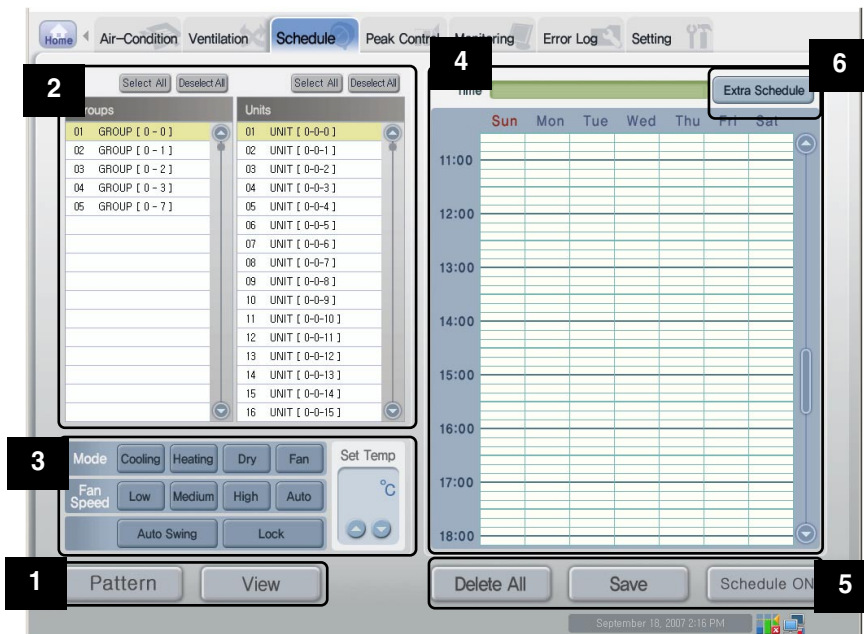

1 Pattern setup button and Mode change button

The schedule set by the user should be stored and applied as pattern. The setup mode and the view mode are classified at the schedule menu to minimize the maloperation of the user.

Pattern setup button

The schedule set by the user should be stored and applied as pattern. The setup mode and the view mode are classified at the schedule menu to minimize the maloperation of the user.

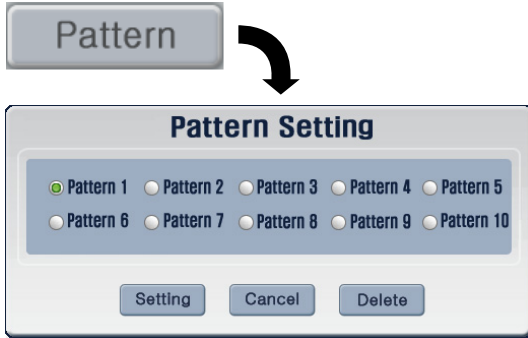

Click [Pattern setup] button to display the Pattern setup window to set the pattern.

Each pattern saves the weekly schedule set, edited and saved by the user. If there is no change after applying the schedule, following schedule that has been set (pattern) will be applied repeatedly in the following week.

If you save the pattern and select the right schedule before operating the schedule, you can operate and apply the schedule. Maximum of 10 patterns can be saved and can be utilized as shown in the following examples.

- Pattern 1: Save schedule pattern mainly used in spring/fall
- Pattern 2: Save schedule pattern mainly used in summer
- Pattern 3: Save schedule pattern mainly used in winter
- Pattern 4: Save schedule pattern used only in the morning at school during summer vacation

When the user does not designate the pattern, the default pattern of 'Pattern 1' is selected. To delete the pattern, select the pattern and click on the [Delete] button. The schedule detail saved in the applicable pattern will be initialized.

Mode change button

The schedule set by the user should be stored and applied as pattern. The setup mode and the view mode are classified at the schedule menu to minimize the maloperation of the user.



When [View mode] button is displayed at the bottom of 'Schedule' menu, the current schedule is set to the view mode. The schedule can not be set and saved at the view mode, and the functions only for checking the set schedule and applying it to the system can be performed.

It'd better use this mode except setting the schedule.



When [Setup mode] button is displayed at the bottom of the 'Schedule' menu, the current schedule is set to the setup mode. At the setup mode, the functions such as setting and saving the schedule can be performed, but the schedule can not be applied to the system. Use this mode only for setting the schedule.

Note: Checking whether to save when changing the mode



When the mode is change to the view mode during setting the schedule, all schedules being setting are cancelled. Before changing to the view mode, decide whether to save the schedule or not.

2 Select Air conditioner group & Air conditioner window

It displays the list of the air conditioner group and the air conditioner set at the system. Also, the air conditioner group and the air conditioner can be selected for setting the schedule.

Select & Deselect All button

The schedule set by the user should be stored and applied as pattern. The setup mode and the view mode are classified at the schedule menu to minimize the maloperation of the user.

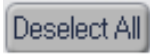

These buttons are located at 'Group' list and 'Air conditioner' list. It is convenient to select or deselect all of the air conditioner

groups or air conditioners from the list. However, the air conditioner group and the air conditioner located at the top of the list are not deselected, because they are selected as default.

Air conditioner group list and Air conditioner list

Groups		Units	
01	GROUP [0 - 0]	01	UNIT [0-0-0]
02	GROUP [0 - 1]	02	UNIT [0-0-1]
03	GROUP [0 - 2]	03	UNIT [0-0-2]
04	GROUP [0 - 3]	04	UNIT [0-0-3]
05	GROUP [0 - 7]	05	UNIT [0-0-4]
		06	UNIT [0-0-5]
		07	UNIT [0-0-6]
		08	UNIT [0-0-7]
		09	UNIT [0-0-8]
		10	UNIT [0-0-9]
		11	UNIT [0-0-10]
		12	UNIT [0-0-11]
		13	UNIT [0-0-12]
		14	UNIT [0-0-13]
		15	UNIT [0-0-14]
		16	UNIT [0-0-15]

The list of the air conditioner group and the air conditioner set at the ACP is displayed at 'Group' and 'Air conditioner.' When you select a specific air conditioner group from the air conditioner group list, the list of the air conditioner(s) belonging to the related air conditioner group is displayed at 'air conditioner' located at the right side.

If the schedule menu operates at the setup mode, when you click the air conditioner group or the air conditioner to select from the list, the related group or the air conditioner is selected, and when you click it again, the related group or air conditioner is deselected.

More than one air conditioner group or air conditioner can be selected together by clicking them. However, at the view mode, only one group or air conditioner can be selected.

3 Schedule control setup window



It displays the list of the air conditioner group and the air conditioner set at the system. Also, the air conditioner group and the air conditioner can be selected for setting the schedule.



At this window, the operation can be set for the air conditioner to be controlled at the specified time according to the schedule. The following operations can be controlled.



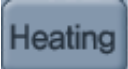

Operation mode

The operation method of the air conditioner can be set at the operation mode. The operation modes to set are as follows:

Item	Description
	<p>It operates the cold operation. The cold operation can set the desired temperature to 18°C ~ 30°C.</p> <p>Note: Setting the desired temperature Because too much cooling is harmful for health, set the suitable desired temperature. About 5°C is better for the difference between the indoor temperature and the outdoor temperature. If the desired temperature is higher than the indoor temperature during the cold operation, it does not operate the cold operation, but the ventilation.</p>
	<p>It drives the heating operation. The heating operation can set the desired temperature to 18°C ~ 30°C.</p> <p>Note: Setting the desired temperature The excessive heating is harmful for the health, so set the suitable desired temperature. About 5°C is better for the difference between the indoor temperature and the outdoor temperature. If the desired temperature is lower than the indoor temperature during the heating operation, it does not operate the heating operation, but the ventilation.</p>
	<p>The dehumidification eliminates moisture. It can effectively eliminate moisture during the rainy season or at the high humidity condition. When it is selected, the desired temperature can not be set.</p>
	<p>It circulates the fresh air. The ventilation only may be used in Spring and Autumn. When it is selected, the desired temperature can not be set.</p>

Air flow

It controls the air flow. The types of air flow to set are as follows:

Air flow	Description
	It sets to ventilate with a small of air flow.
	It sets to ventilate at the medium level of air flow.
	It sets to ventilate at the high level of air flow.
	It sets to automatically ventilate at the suitable level of air flow for the environment with the indoor unit installed.

Air direction

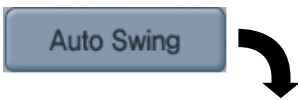

It sets the air direction of the current air conditioner. It can set the direction of the air conditioner to be changed to left & right or up & down.

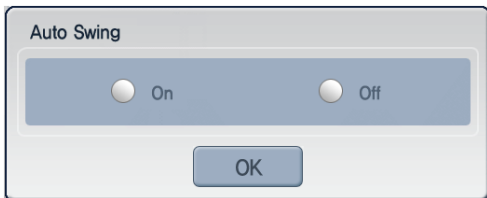

Click [Air direction setup] button to display the window to set the air direction. When you set the air direction and click [Done] butto, the air direction is set.

Lock



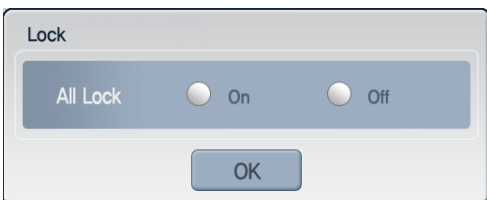

It sets the lock function of the air conditioner. When the lock function is set, the air conditioner can not be controlled by the wirless or wired remote controller. Use the lock function not for the user individually, button to centrally control the air conditioner.



Click [Lock setup] button to display the window to set the Lock function. When you set the Lock function and click [Done] button, the lock function is set.

Desired temperature

Set the desired indoor temperature of the air conditioner. The desired temperature can be set by clicking  or . The desired temperature can be set for both the cooling and the heating with the range of 18°C ~ 30°C. The desired temperature can not be set at the Dehumidification mode and the Ventilation mode.

4 Weekly operation schedule display window

It displays the weekly operation schedule and the operation time. Also, it can handle the specific date as exceptional schedule.

Operation time display

It displays the operation start time and the operation stop time of the period selected from the weekly operation schedule table.

Schedule display window

	Sun	Mon	Tue	Wed	Thu	Fri	Sat
11:00							
12:00							
13:00							
14:00							
15:00							
16:00							
17:00							
18:00							

At the view mode, the current set schedule is displayed at the schedule display window. However, at the setup mode, the period to set the schedule can be selected.

One column of the display window corresponds to 10 minutes, and, at the setup mode, more than one period can be deleted by clicking the set period again.

The time with the schedule set is displayed in sky blue while the period selected by clicking is displayed in green.

When you select the period with the schedule set, the setting of the related schedule is displayed at the schedule control setup window at the left of the screen.

5 Save the setting button & Apply/Cancel the schedule button

Use [Delete All] or [Save the setting] button to initialize the schedule or set and save the schedule at the system. Also, [Apply the schedule] and [Cancel the schedule] buttons are used to apply and cancel the saved schedule to the system.

Delete All button



Click [Delete All] button to delete all schedule information being edited at the setup mode. Also, all schedule time information displayed at the schedule display window are deleted.

Save the setting button



It saves the information set at the schedule screen. All set information can be saved only by clicking [Save the setting] button. Especially, if you click [View mode] button without pressing this button to save after setting the schedule at the setup mode, the schedule information set up to now may be cancelled, so be careful.

Apply & Cancel the schedule button

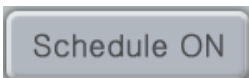

Click [Apply the schedule] button to apply the schedule saved as pattern to the system to be performed. Because applying the schedule is not performed at the setup mode on the system screen, this button cannot be pressed. When the schedule is applied, it is changed to the pattern name with [Pattern setup] button applied, and [Apply schedule] button is changed to [Cancel the schedule] button.

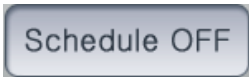

When you click [Cancel the schedule] button, the schedule operation currently being operated is stopped. Also, the button displaying the applied schedule pattern is changed to [Pattern setup] button.

6 Exception handling schedule button

The screenshot shows the 'Extra Schedule' screen. At the top left is a button labeled 'Extra Schedule' with a curved arrow pointing to the main screen. The main screen has a 'Close Extra Sch' button at the top right. Below the title bar is a table with two columns: 'Date' and 'Title'. To the left of the table is a 'Date Selection' section showing a calendar for '2007 SEP' with days of the week (Sun-Sat) and dates (1-29). Below the calendar is an 'Input Title' field and buttons for 'Add', 'Delete', 'Save', and 'Search'. At the bottom, there are controls for 'All stop' (Set/Release) and an 'OK' button.

It is the function excluding the specified date from the set weekly operation schedule. The other schedule can be set to the excluded date suitable to the related date.

When you click [Exception handling schedule] button, the exception handling schedule screen is displayed as shown at the left. At this time, [Exception handling schedule] button is changed to [Exit the exception handling] button.

In order to exit from the exception handling schedule screen to the previous screen, press [Exit the exception handling] button.

Exception handling schedule & Exit the exception handling button

Extra Schedule

When you click [Exception handling schedule] button, the exception handling schedule screen to set the exception handling schedule is displayed. At this time, [Exception handling schedule] button is changed to [Exit the exception handling] button.

Close Extra Sch

When you click [Exit the exception handling] button, it exits the current exception handling schedule screen and returns to the schedule setup screen. At this time, [Exit the exception handling] button to [Exception handling schedule] button.

Exception handling list

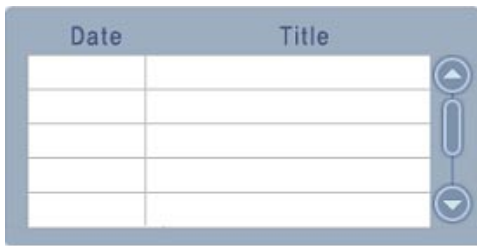

Date	Title

The exception handling list displays the currently set exception handling schedule.



Date Selection

2007 SEP

Sun Mon Tue Wed Thu Fri Sat

1

2 3 4 5 6 7 8

9 10 11 12 13 14 15



16 17 18 19 20 21 22

23 24 25 26 27 28 29

Input Title

Add Delete Save Search

You can enter the date to set the exception handling schedule and the title, and add a new one or delete/find the existing exception handling schedule.

In order to set the exception handling schedule, use ,  button at the Select date window to select the year and the month.

When you enter the title for the exception handling schedule into 'Title input' field and click [Add] button, the exception handling date is displayed on the screen. And then, when you click [Save] button, the related setting is applied to the system.

In order to delete the existing setting, after specifying the related data at the calendar, when the exceptional schedule title to delete is displayed at 'Title input' field, click [Delete] button. And then, when you click [Save] button, the related schedule is deleted from the system.

When you specify the exception handling title at the Date selection window and click [Find] button, the related exception handling schedule is displayed at the exception handling schedule display screen at the right of the screen.

Exception handling schedule display window

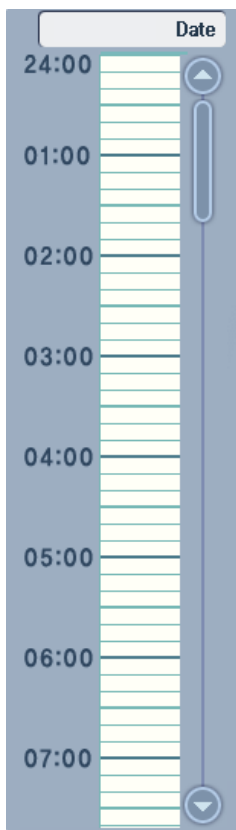

The method to specify the schedule at the exception handling date is same to the general schedule setup.

At the view mode, the schedule about the exception handling schedule is displayed at the exception handling schedule display window. While, at the setup mode, you can select the period to set the exception handling schedule.

In order to schedule for the exception handling schedule, you should check the exception handling schedule at the exception handling list and specify the related data at the Date selection window.

Make sure that the title of the exception handling schedule is displayed at 'Title input' field of the Date selection window and the related date is displayed at 'Schedule' item at the exception handling schedule display window. If the date is not displayed, you should specify the exception handling schedule by the Date selection window first.

One column of the display window corresponds to 10 minutes, and, at the setup mode, more than one period can be deleted by clicking the set period again.

You can delete the period by clicking the period again.

The time with the exception handling schedule set is displayed in sky blue while the period selected by clicking is displayed in green.

When you select the period with the exception handling schedule set, the setting of the related schedule is displayed at the schedule control setup window at the left of the screen.

Stop All window

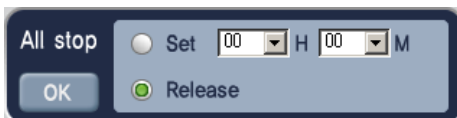

It can stop all air condition system at the specified time. It is optional, so it is not the essential item to be set for setting the exception handling schedule.

In order to perform this function, click [Setup] radio button, set the time, and click [Done] button. But, in

order to deselect this function, click [Deselect] radio button and then [Done] button.

It has the priority higher than the schedule or the exception handling schedule, so all air conditioners are stopped at the specified time even when the air conditioner operates according to the schedule.

However, it operates only when the specified schedule is applied and operates (it does not operate at the schedule stopped condition).

Example for setting the schedule

This section describes the method for setting the schedule and the exception handling schedule based on the group with the name '1st grade.'

Setting the schedule for the 1st grade class

The following example shows the procedure for applying the following setting to the system as schedule.

- Target group: '1st grade' group
- Time: 9~11, 1~3 a.m.
- Operation: Cooling, Air flow 'Middle', Temperature '23°C', Lock function set
- Saving pattern: Pattern5

1. When you click 'Schedule' menu at the LG ACCS screen, the following screen is displayed. Click [View mode] button to switch to the schedule setup mode. When you click [View mode] button, it is switched to the setup mode and the [View mode] button is changed to [Setup mode] button.

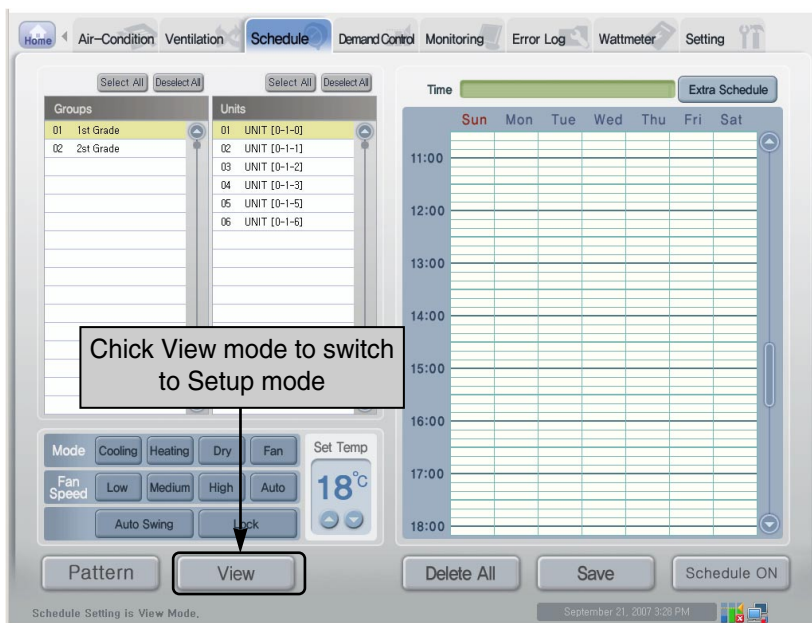

- Specify the pattern to save the schedule. In this example, the schedule is specified to the Pattern5. Click [Pattern setup] button, click Pattern5' item at the displayed Pattern setup' window, and click [Set] button. If the pattern is not selected, it is saved at Pattern1' as default.

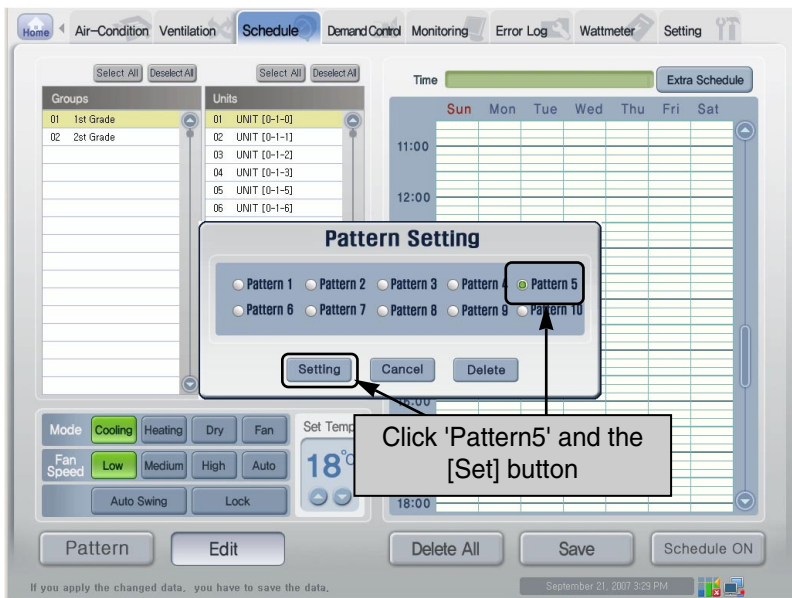

- Now, select the target to which the schedule is applied. Here, because it is applied to all '1st grade' group, all air conditioners are selected by pressing [Select All] button.

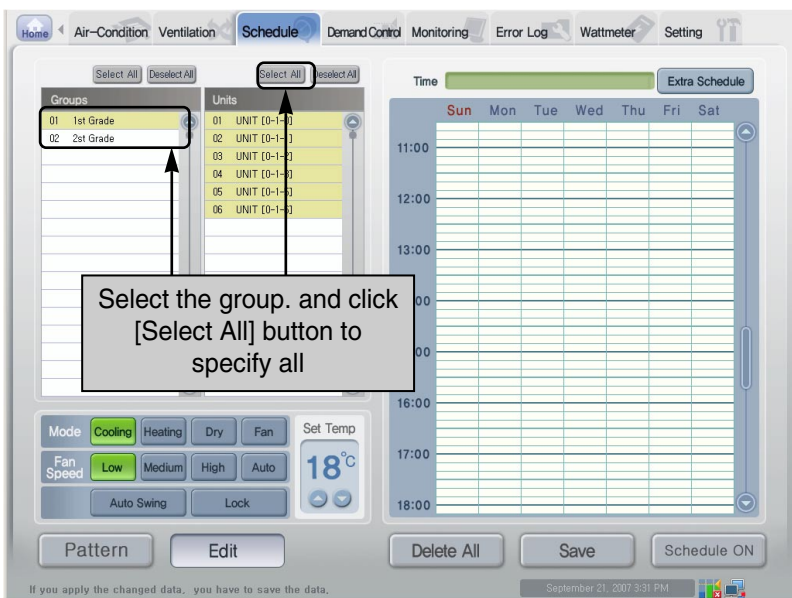

4. Now, specify the operation for the schedule to perform. Set 'Cooling operation' as operation, 'Middle' as air flow, and '23°C as desired temperature.

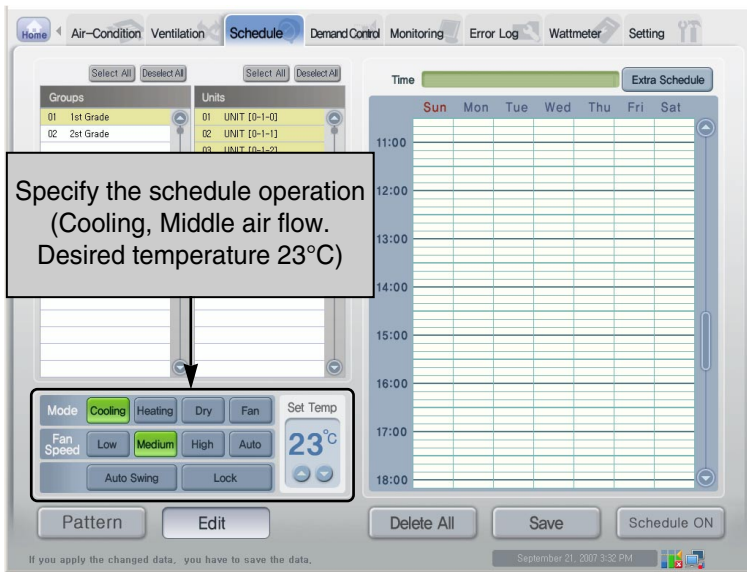

5. Set the Lock function for the user not to individually set the air conditioner. When you click [Lock setup] button, the Lock setup window to set the lock function is displayed. Click 'Set' radio button and then [Done] button.

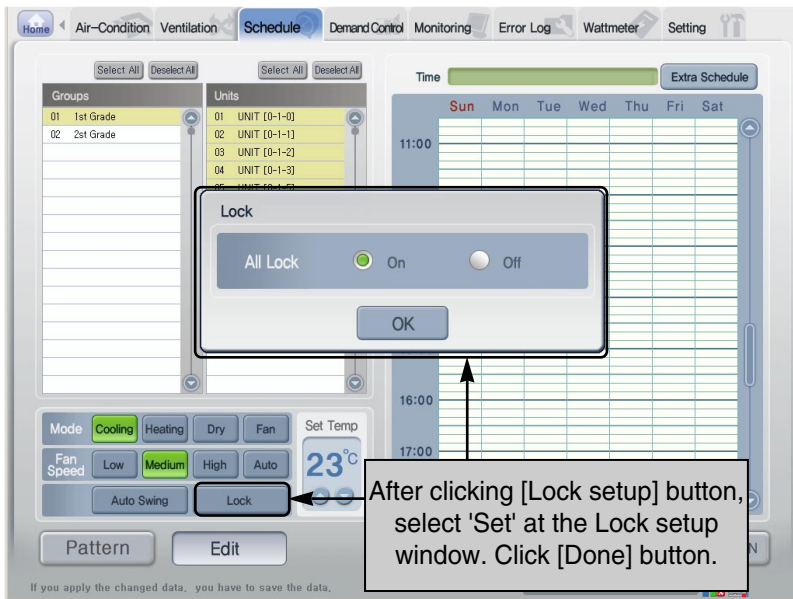

6. Select the time to apply the schedule. At the schedule setup window at the right side of the screen, select '9~11 a.m.' and '1~3 p.m.' from Monday to Friday by clicking or dragging.

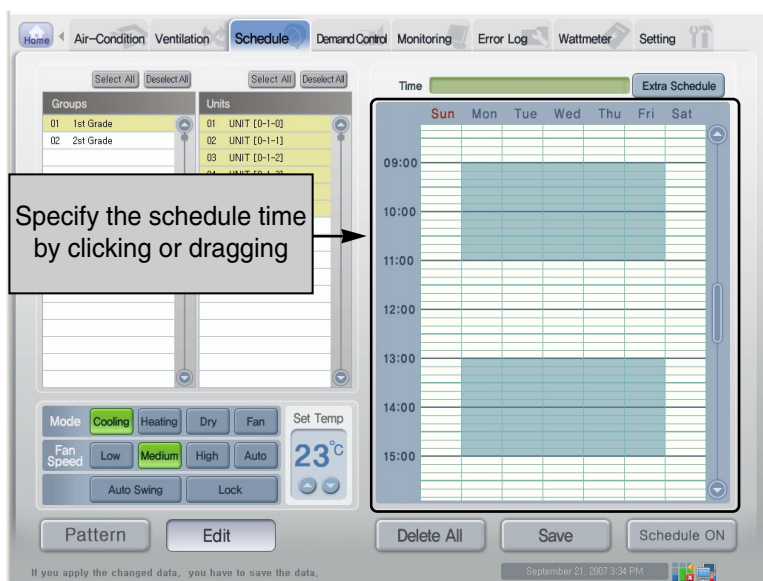

7. Now, press [Save the setting] button to save the set schedule. When you click [Save the setting] button, the window to confirm saving is displayed. Click [Done] button to save the schedule.

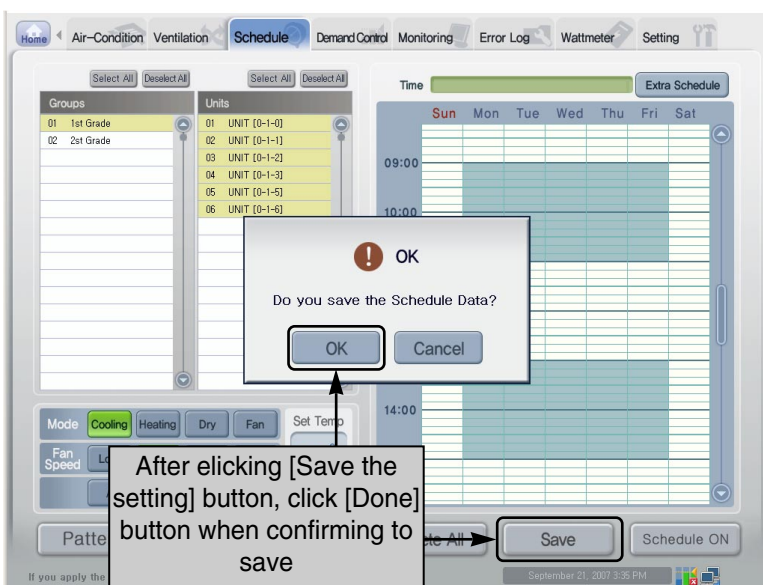

8. Now, press [Setup mode] button to switch to the view mode. When you click each air conditioner name of the 1st grade, you can find that the same schedule is applied to each group. Also, you can find which operation is set by clicking the schedule time.

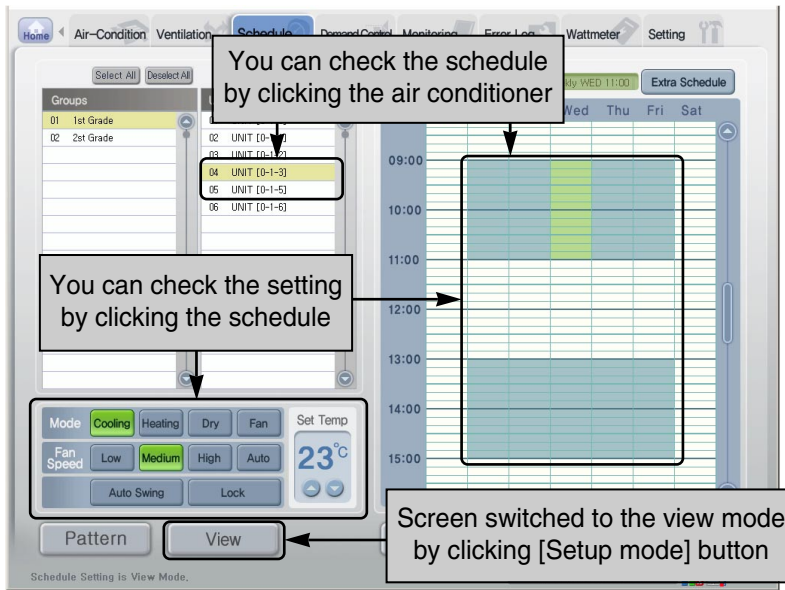

9. When you click [Apply the schedule] button, the set schedule operates. [Apply the schedule] button is changed to [Cancel the schedule] button. [Pattern setup] button is displayed with the currently applied pattern number.

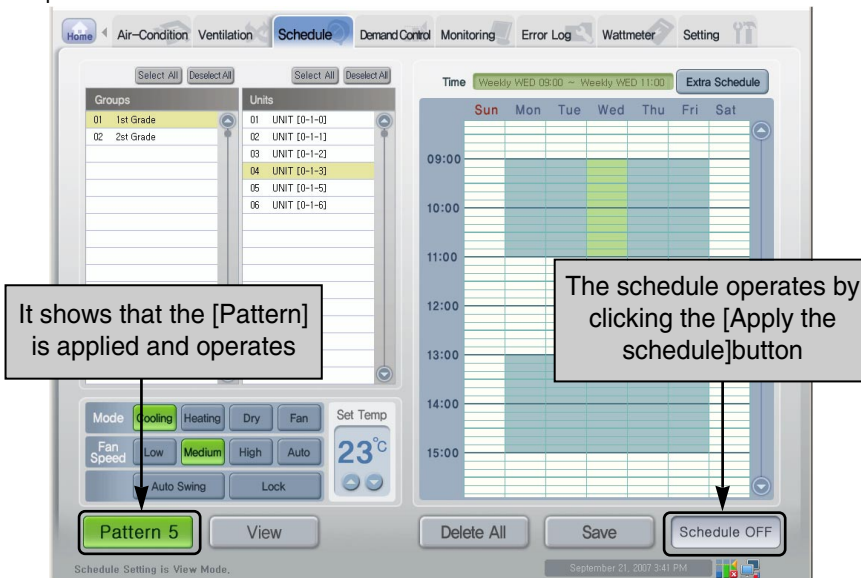

Setting the exception handling schedule

The method to set the exception handling schedule is similar to the method to set the schedule. The following example shows the procedure for applying the following exception handling schedule to the system.

- Target group: '1st grade' group
- Date: 2007. 7. 6.
- Exception handling title: 'Discretional holiday'
- Time: 9~12 a.m.
- Operation: Cooling, 'Weak' as air flow, '25°C' as temperature
- Total stopped time: 12:00

1. When you click [Exception handling schedule] button at 'Schedule' menu screen, the screen to set the exception handling is displayed. At this time, the [Exception handling schedule] button is changed to [Exit the exception handling] to exit from setting the exception handling schedule.

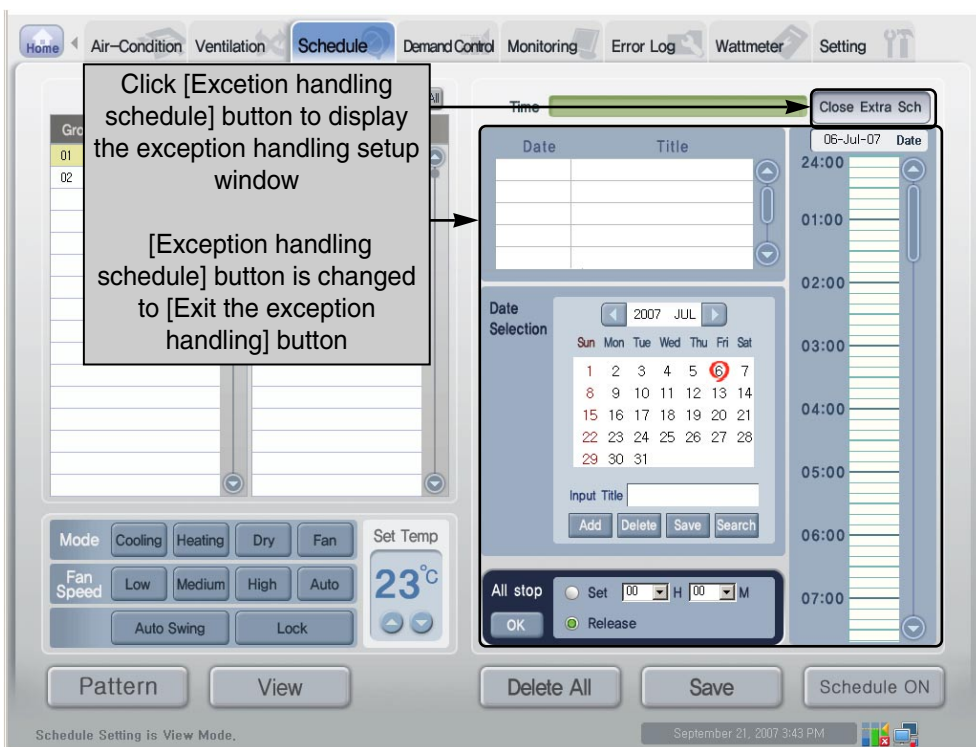

2. Select the data for adding the exceptional date from the calendar. And then, when you enter the exceptional schedule title into 'Title input' field and click [Add] button, the exception schedule is added to the list. Here, the exception schedule with the title 'Discretional holiday' to 2007.7.6.

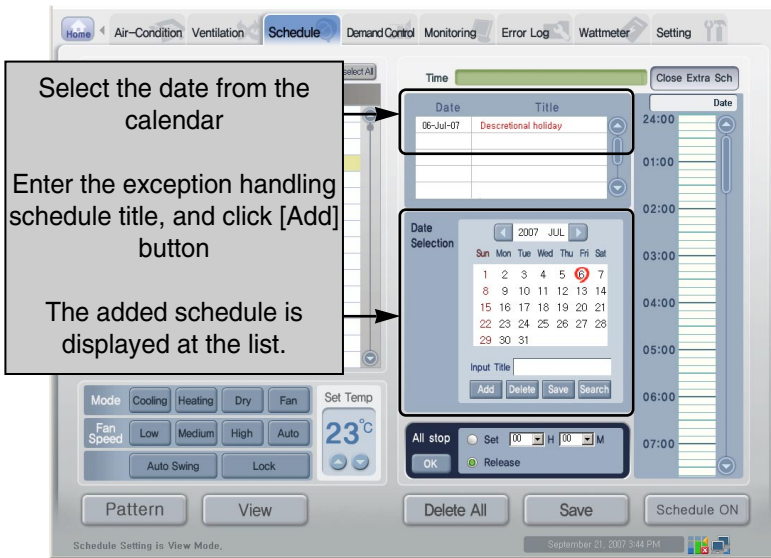

3. The exception schedule title is added to the list, but it is not saved at the system. Click [Save] button to save the exception handling title at the system. If you do not click [Save] button, the related information is deleted when switching to the other screen.

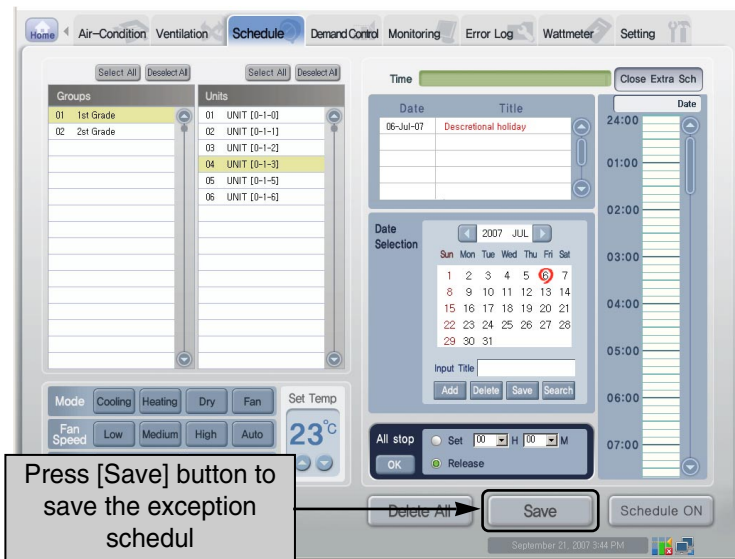

4. Now, apply the schedule to the exception handling schedule. First, check the date at the exception handling schedule list, and then select the date from the calendar. The related exception handling schedule title is displayed at 'Title input' field, and make sure that the related date is displayed at 'Schedule' field.

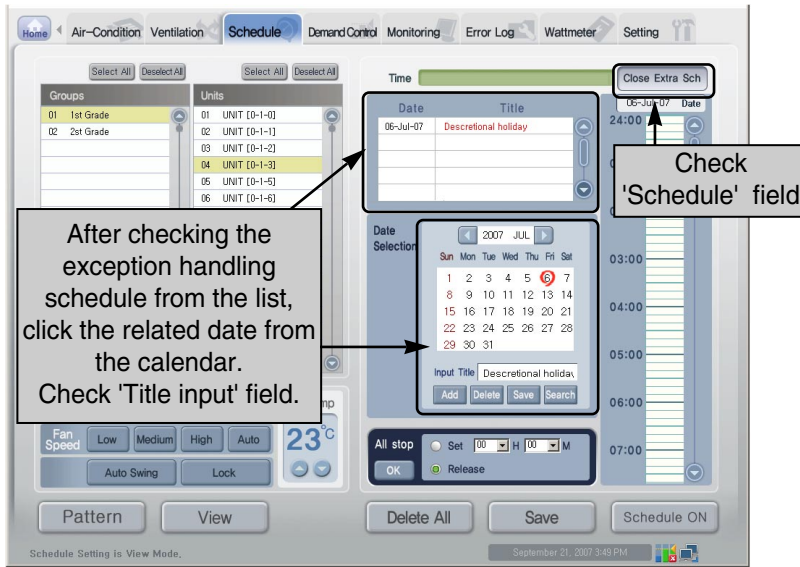

5. Click [View mode] button to switch to the schedule setup mode. When you click the [View mode] button, it is switched to the setup mode and [View mode] button to [Setup mode] button.

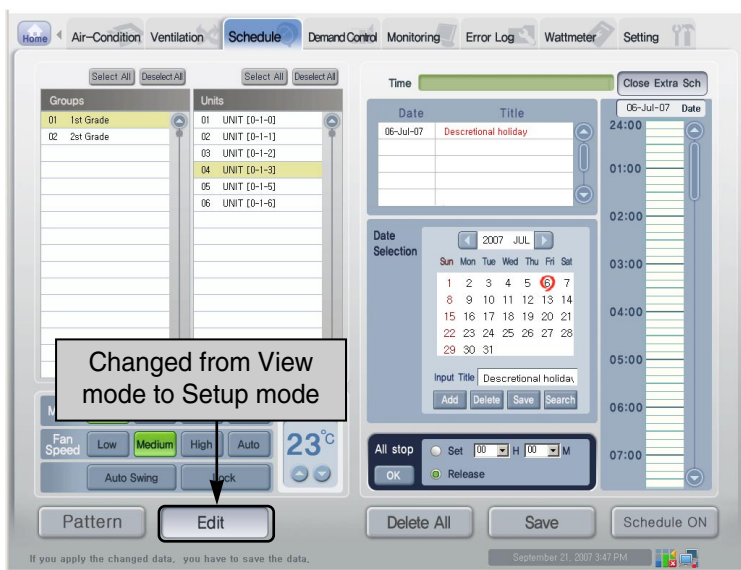

6. Select the target to which the exception handling schedule is applied. Here, because it is applied to all '1st grade' group, all air conditioners are selected by pressing [Select All] button.

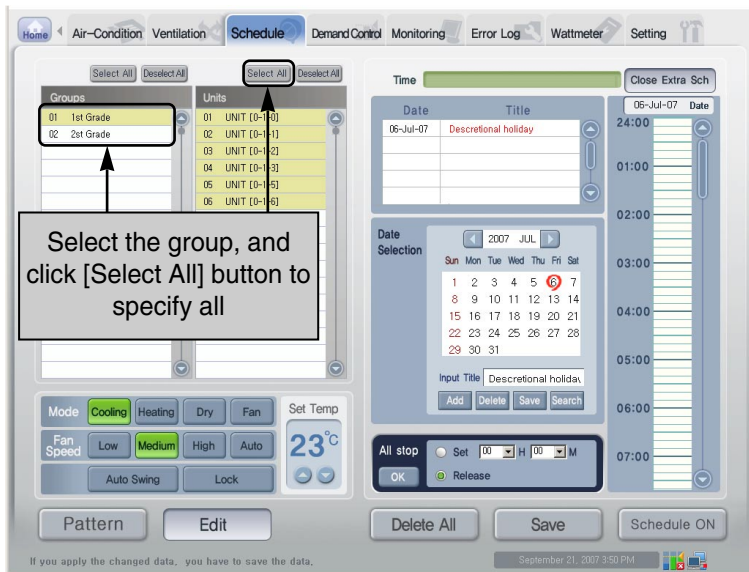

7. Now, specify the operation for the schedule to perform. Set 'Cooling operation' as operation, 'Weak' as air flow, and '25°C as desired temperature.

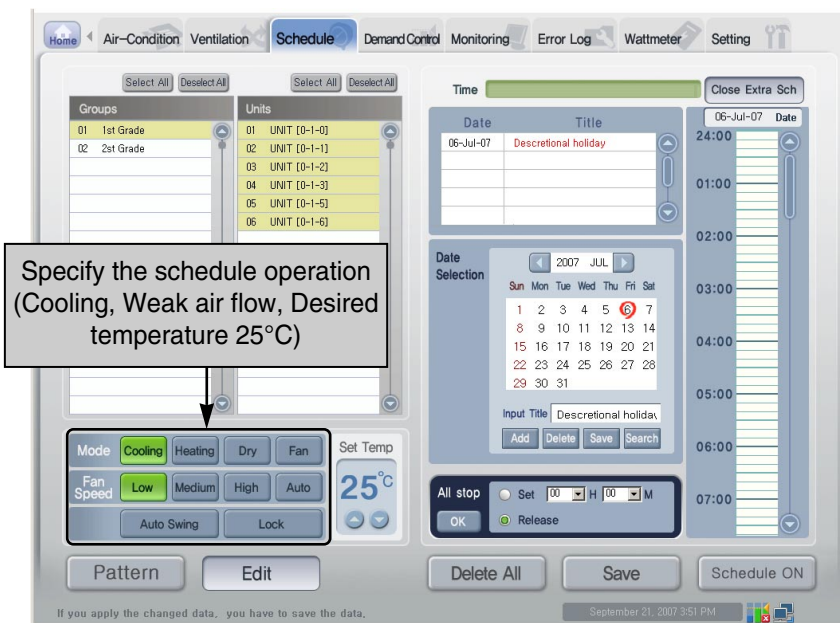

8. Select the time to apply the schedule. At the schedule setup window at the right side of the screen, select '9~12 a.m.' by clicking or dragging.

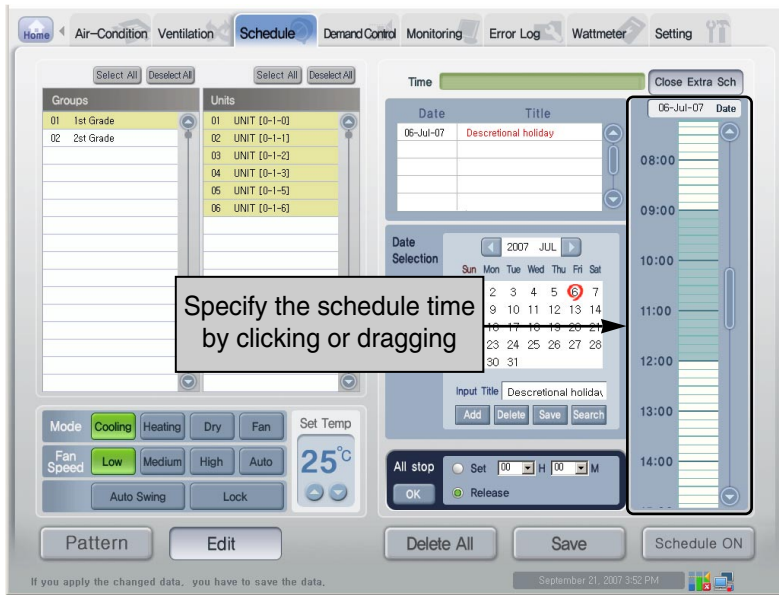

9. Set to stop all air conditioners at 12:00. Set '12:00' at 'Stop All' item and click [Done] button.

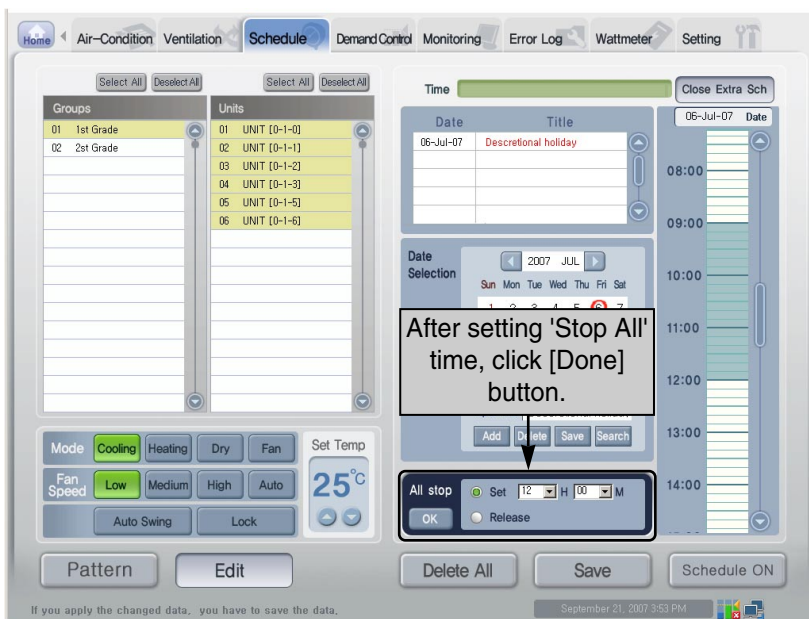

10. Now, press [Save the setting] button to save the set exception handling schedule. When you click [Save the setting] button, the window to confirm saving is displayed. Click [Done] button to save the exception handling schedule.

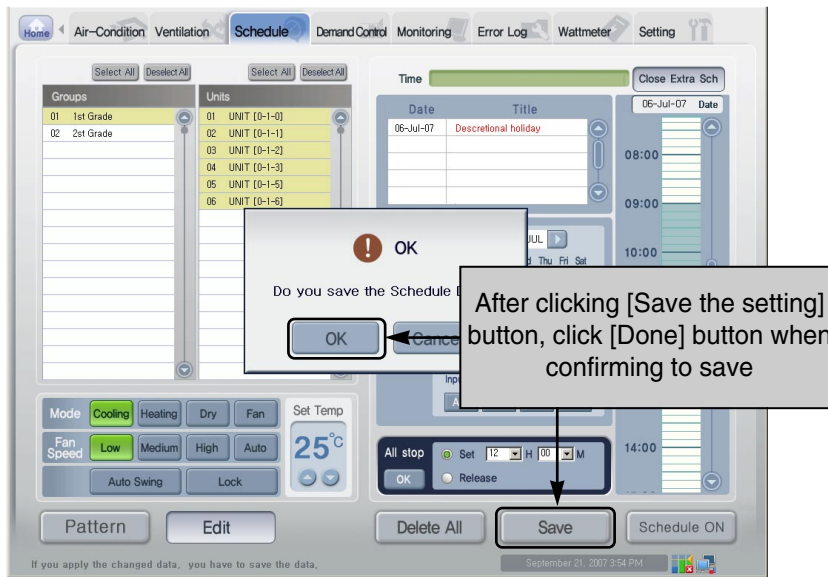

11. Now, press [Setup mode] button to switch to the view mode. When you click each air conditioner name of the 1st grade, you can find that the same schedule is applied to each group. Also, you can find which operation is set by clicking the schedule time.

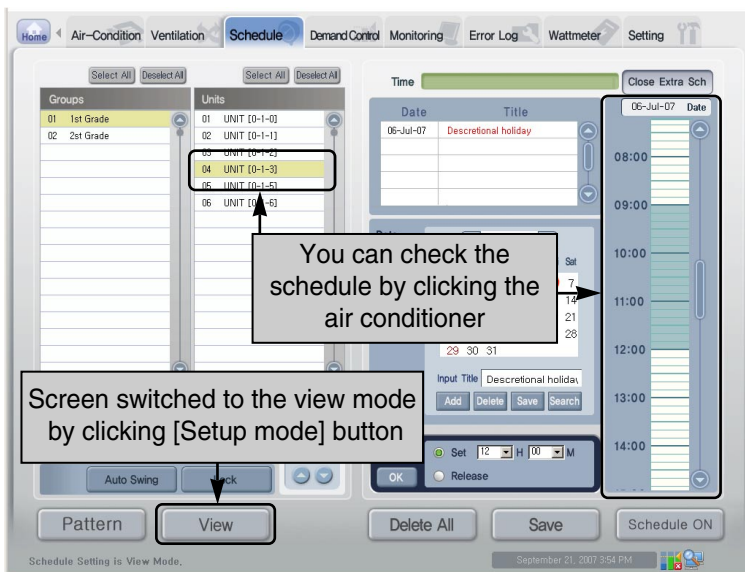

12. When setting the exception handling schedule is completed, click [Exit the exception handling] button to close the exception handling setup window and return to the previous schedule view screen.

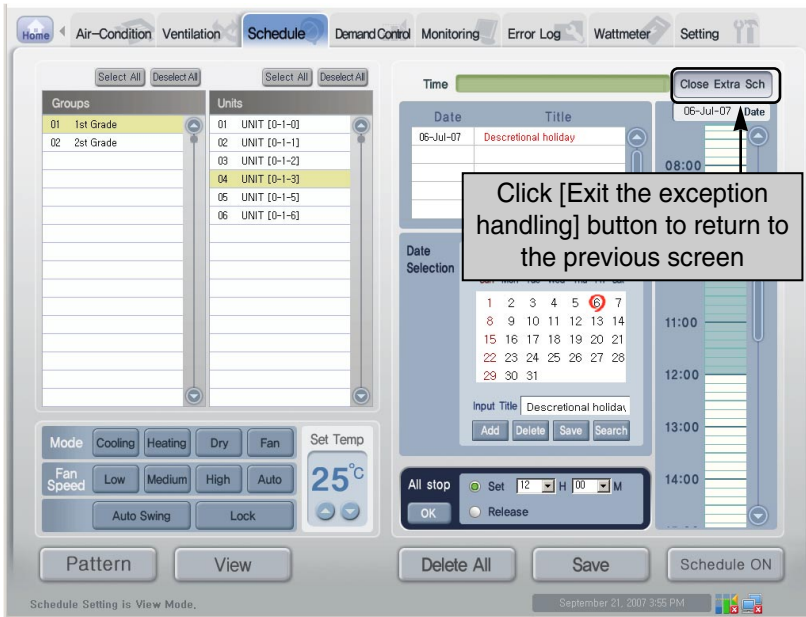

Controlling the peak operation ratio

It maintains the consumed power to be kept lower than or equal to the target power by monitoring the wattage of the air conditioner. It can control to save the energy by forcefully starting or stopping the air conditioner according to the specified peak operation rule.

It has the following advantages:

- Centrally control all installed air conditioners by using the computer screen.
- Monitor and control the peak operation ratio for 24 hours a day.
- Easily perform controlling and monitoring.
- Set the peak control function by wattage (kW) or operation ratio (%).
- Control the operation switching period (5~15 minutes) of the air conditioner.
- Set the exceptional air conditioner not to apply the peak operation ratio control function.

Note: Peak operation ratio control & Demand control

The ACCS offers the peak operation ratio control function and the demand control function to reduce the power cost by operating all air conditioners less than or equal to the permitted demand power. One of the peak operation ratio control function or the demand power control function can be used depending on the function setting of the ACP, but two functions cannot be used together.

This section describes the method for controlling the peak operation ratio. For more information about the demand control function, see Chapter 3. 'Controlling the demand power'.

The air conditioner forcefully operating by the peak operation ratio control function operates at the ventilating mode during the cooling operation while the operation stops during the heating operation. But, the user's inconvenience due to setting the peak operation period is minimized.

When the air conditioner forcefully operates by the peak operation ratio control function, the air conditioner cannot be individually managed because the automatic central control is used. However, when the current operation uses the power less than or equal to the target operation ratio setting, the air conditioner can be individually managed.

Caution: When the ACP is interconnected with the AC Manager



When the ACP is interconnected with the AC Manager, set Demand as ACP setting. The ACP operates according to the demand setting of the AC Manager.

In order to control the peak operation ratio, click 'Peak power' menu at the top of the LG ACCS. When you click 'Peak power' menu, the following air conditioner control screen is displayed.



Note: When there is no peak power menu

If the ACCS menu does not have 'Peak power' menu but 'Demand' menu, it is set for the setting of the ACP to use the demand power control function. In order to use the peak power control function, change the setting of the ACP by referring to Chapter 2. "Setting the ACP functions – Selecting Peak or Demand."

Caution: When the peak power function is used

 When the peak power function is used, the function should be used or set after the current information about 'Current operation ratio/Current power' and 'Operation stats' item. The wattage information may be delayed to be displayed according to the network environment.



1 Wattage monitor

The following peak control setting information and operation information are displayed at the wattage monitor.

- Function operation status
- Current wattage and operation ratio
- Desired wattage and operation ratio
- Operation switching period

Function operation information

At the function operation status, the operation status of the current peak control is displayed. The types of the displayed operation status are as follows:

Operation status	Description
	Displayed when the current wattage is higher than the setting value of the peak operation ratio control function. In this case, the air conditioner operates at the condition to start or stop with the peak operation period according to the peak operation ratio control function.
	Displayed when the peak operation ratio control function is stopped.
	Displayed when the setting value of the peak operation ratio control function is higher than the wattage. In this case, the air conditioner can not be operated or stopped with the peak operation period and operates at the condition for monitoring that the wattage is getting higher than the setting value.

Current wattage and operation ratio

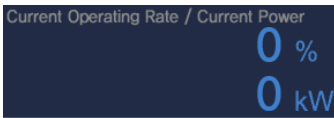

It displays to which percentage of the entire operation ratio the operation ratio of the current air conditioner reaches. Also, it displays the current wattage in kW.

Desired wattage and operation ratio



It displays to which percentage of the entire air conditioner operation ratio the operation ratio of the desired air conditioner reaches. Also, it displays the desired wattage in kW per hour.

Operation switching period

Cycle

5 min

It displays the period for stopping the peak operation. For example, if it is set to 5 minutes period, the air conditioners with the peak operation are switched every 5 minutes, which controls the time for all air conditioners to stop constantly.

The operation switching period can be controlled within the range of 5~15 minutes.

2 Setting the current operation status and the power control (graph)

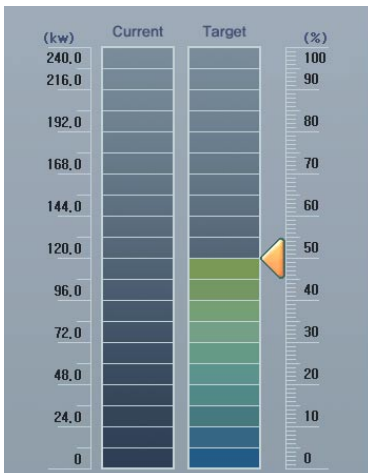

The graph for displaying the current operation status and setting the power control function is displayed at the left side of the peak operation ratio control screen. The operator can use this graph to check the power when all current installed air conditioners operate 100% and to set the target power.

In order to change the peak operation ratio, drag  to set the target power.

Note: Changing the peak operation ratio

In order to change the peak operation ratio, except the method using , it can be set by the number input method described at the following section.

3 Setting the power control (text)



The setup item to set the wattage in kW or % is displayed at the right side of the peak operation ratio control screen.

If it exceeds the setting value, the air conditioner operates with the peak operation function periodically according to the peak power operation rule.

Desired power



It sets the desired wattage in kW per hour to operate the peak operation function. It can be adjusted to the half of the maximum usage by 1kW.

When the value is set by kW, the desired operation ratio(%) is also changed according to the setting value.

Desired operation ratio



It sets the desired wattage in percentage to operate the peak operation function. It can be set within the range of 0~100% of the maximum wattage, which can be controlled by 1%.

When the value is set by %, the desired power (kW) is changed according to the setting value.

Operation switching period

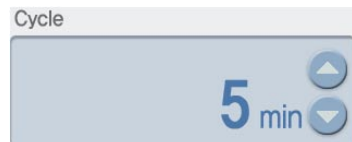

It sets the peak operation period. It can be set within the range of 5~15 minutes, which can be controlled by 1 minute.

4 Peak excluded air conditioner**Excluded Units**

Press [Peak excluded air conditioner] to set the air conditioner not to apply the peak operation control function. When you click [Peak control air conditioner] button, the following setup screen is displayed.

Applied Units		Excluded Units	
Index	Units	Index	Units
0	GROUP [0 - 0] UNIT [0-0-0]	0	GROUP [0 - 0] UNIT [0-0-0]
1	GROUP [0 - 0] UNIT [0-0-1]	1	GROUP [0 - 0] UNIT [0-0-1]
2	GROUP [0 - 0] UNIT [0-0-2]		
3	GROUP [0 - 0] UNIT [0-0-3]		
4	GROUP [0 - 0] UNIT [0-0-4]		
5	GROUP [0 - 0] UNIT [0-0-5]		
6	GROUP [0 - 0] UNIT [0-0-6]		
7	GROUP [0 - 0] UNIT [0-0-7]		
8	GROUP [0 - 0] UNIT [0-0-8]		
9	GROUP [0 - 0] UNIT [0-0-9]		
10	GROUP [0 - 0] UNIT [0-0-10]		
11	GROUP [0 - 0] UNIT [0-0-11]		
12	GROUP [0 - 0] UNIT [0-0-12]		
13	GROUP [0 - 0] UNIT [0-0-13]		

In order to set the air conditioner not to apply the peak operation control function, select the air conditioner at 'All air conditioners' at the left side of the setup screen, and click [Exclude] () button. The related air conditioner is displayed at 'Peak excluded air conditioner' at the right side of the screen.

However, in order to apply the peak operation control function to the air conditioner, select the air conditioner from 'Peak excluded air conditioner', and press [Apply] () button. The related air conditioner is displayed at 'All air conditioners' at the left side of the screen.

Note: Changing the setting value of the desired wattage and operation ratio

The setting values of the desired wattage and the desired operation ratio are changed according to the setting of the peak excluded air conditioner. As the number of the peak excluded air conditioners is getting higher, the number of air conditioners individually operated by the user may be getting higher. In this case, the other air conditioners not peak excluded may operate more frequently.

Caution: Initializaing the peak excluded air conditioner



When you execute 'Save' after setting the system information at 'System setup' menu, the existing information of the peak excluded air conditioner is initialized, so be careful.

5 Saving the setting

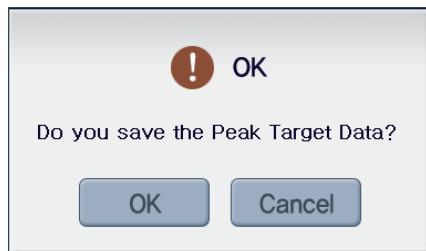

It saves the setting values of the peak operation ratio control up to now.

When you press [Save] button, the window to conform saving is displayed. When you want to save the setting, click [Done] button, but click [Cancel] button to cancel.

Note: Setting the peak

Set the peak at the peak operation condition, or perform the peak operation after setting the peak. After setting the peak, if the peak operation is not performed, the actual peak operation ratio is not set.

6 Starting & stopping

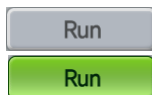

It starts the peak operation ratio control function. When the peak operation ratio control is being operated, the button is displayed in green.



It stops the peak operation ratio control function. When the peak operation ratio control is stopped, the button is displayed in green.

Controlling the demand power

It maintains the consumed power to be kept lower than or equal to the target power by monitoring the wattage of the air conditioner. It can control to save the energy by using the demand controller connected to the ACP forcefully to start or stop the air conditioner.

It has the following advantages:

- Precise management by controlling the automatic operation ratio of the air conditioner with the demand controller.
- Monitor and control the peak power for 24 hours a day.
- Easily perform controlling and monitoring.

Note: Peak operation ratio control & Demand control

The ACCS offers the peak operation ratio control function and the demand control function to reduce the power cost by operating all air conditioners less than or equal to the permitted demand power. One of the peak operation ratio control function or the demand power control function can be used depending on the function setting of the ACP, but two functions cannot be used together.

This section describes the method for controlling the demand power. For more information about the peak operation ratio function, see Chapter 3. 'Controlling the peak operation ratio'.

When the air conditioner forcefully operates by the demand power control function, the air conditioner cannot be individually managed because the automatic central control is used. However, when the current operation uses the power less than or equal to the target operation ratio setting, the air conditioner can be individually managed.

In order to control the demand power, click 'Demand power' menu at the top of the LG ACCS. When you click 'Demand power' menu, the following air conditioner control screen is displayed.



Note: When there is no demand menu

If the ACCS menu does not have 'Demand' menu but 'Peak power' menu, it is set for the setting of the ACP to use the peak control function. In order to use the demand power function, change the setting of the ACP by referring to Chapter 2. "Setting the ACP functions – Selecting Peak or Demand."



1 Wattage monitor

The following demand control setting information and operation information are displayed at the wattage monitor.

- Function operation status
- Current wattage and operation ratio
- Desired wattage and operation ratio
- Operation switching period

Function operation information

At the function operation status, the operation status of the current demand control is displayed. The types of the displayed operation status are as follows:

Operation status	Description
	Displayed when the current wattage is higher than the setting value of the demand control function. In this case, the air conditioner operates at the condition to start or stop according to the demand control function.
	Displayed when the demand control function is stopped.
	Displayed when the setting value of the demand control function is higher than the wattage. In this case, the air conditioner can not be operated or stopped and operates at the condition for monitoring that the wattage is getting higher than the setting value.

Current wattage and operation ratio

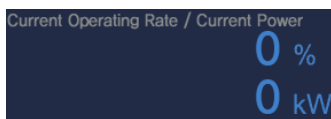

It displays to which percentage of the entire operation ratio the operation ratio of the current air conditioner reaches. Also, it displays the current wattage in kW.

Desired wattage and operation ratio

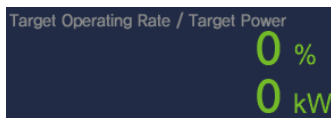

It displays to which percentage of the entire air conditioner operation ratio the operation ratio of the desired air conditioner reaches. Also, it displays the desired wattage in kW per hour.

Operation switching period

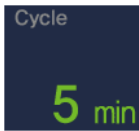

It displays the period for stopping the peak operation. For example, if it is set to 5 minutes period, the air conditioners with the peak operation are switched every 5 minutes, which controls the time for all air conditioners to stop constantly.

The operation switching period can be controlled within the range of 5~15 minutes.

2 Setting the current operation status and the power

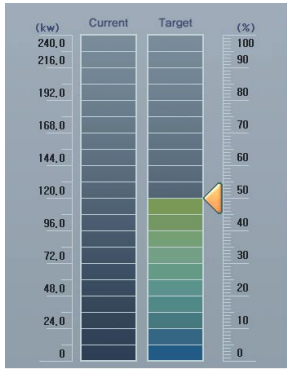

The graph for displaying the current operation status and setting the power control function is displayed at the left side of the demand control screen. The operator can use this graph to check the power when all current installed air conditioners operate 100% and to check the set target power.

Caution: Setting the demand control

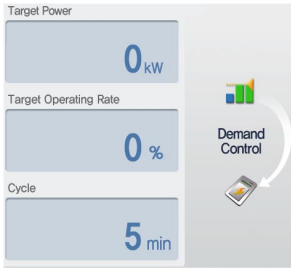

Because the demand control is set by the externally connected demand controller, the items such as desired power, desired operation ratio and operation switching period can not be set within the LG ACCS program.

3 Setting the power control (text)

The setup item to set the wattage in kW or % is displayed at the right side of the peak operation ratio control screen.

If it exceeds the setting value, the air conditioner is forcefully operated periodically according to the peak power operation rule.

Desired power

It displays the desired power in kW per hour to operate the peak operation function.

Desired operation ratio

It displays the desired power in % to operate the peak operation function.

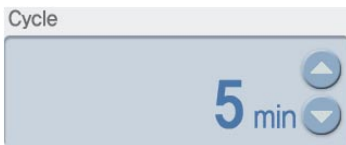
Operation switching period

It displays the period to forcefully stop the operation.

Caution: Setting the demand control

Because the demand control is set by the externally connected demand controller, the items such as desired power, desired operation ratio and operation switching period can not be set within the LG ACCS program.

Monitoring the air conditioner status

You can see the operation status and the error status of each air conditioner set all air conditioner groups at the LG ACCS at a glance. In order to view the status information of the air conditioner, click 'Monitoring' menu at the top of the LG ACCS. When you click 'Monitoring' menu, the following monitoring screen is displayed.

Units	Mode	Fan Speed	Auto Swing	All Lock	Temp Lock	Temp	Set Temp	On/Off	Details
GROUP [0 - 0] - UNIT [0-0-0]	NE								CH[244] Error is Occurred.
GROUP [0 - 0] - UNIT [0-0-1]	NE								CH[244] Error is Occurred.
GROUP [0 - 0] - UNIT [0-0-2]	NE								CH[244] Error is Occurred.
GROUP [0 - 0] - UNIT [0-0-3]	NE								CH[244] Error is Occurred.
GROUP [0 - 0] - UNIT [0-0-4]	NE								CH[244] Error is Occurred.
GROUP [0 - 0] - UNIT [0-0-5]	NE								CH[244] Error is Occurred.
GROUP [0 - 0] - UNIT [0-0-6]	NE								CH[244] Error is Occurred.
GROUP [0 - 0] - UNIT [0-0-7]	NE								CH[244] Error is Occurred.
GROUP [0 - 0] - UNIT [0-0-8]	NE								CH[244] Error is Occurred.
GROUP [0 - 0] - UNIT [0-0-9]	NE								CH[244] Error is Occurred.
GROUP [0 - 0] - UNIT [0-0-10]	NE								CH[244] Error is Occurred.
GROUP [0 - 0] - UNIT [0-0-11]	NE								CH[244] Error is Occurred.
GROUP [0 - 0] - UNIT [0-0-12]	NE								CH[244] Error is Occurred.
GROUP [0 - 0] - UNIT [0-0-13]	NE								CH[244] Error is Occurred.
GROUP [0 - 0] - UNIT [0-0-14]	NE								CH[244] Error is Occurred.
GROUP [0 - 0] - UNIT [0-0-15]	NE								CH[244] Error is Occurred.
GROUP [0 - 1] - UNIT [0-1-0]	NE								CH[244] Error is Occurred.
GROUP [0 - 1] - UNIT [0-1-1]	NE								CH[244] Error is Occurred.
GROUP [0 - 1] - UNIT [0-1-2]	NE								CH[244] Error is Occurred.
GROUP [0 - 1] - UNIT [0-1-3]	NE								CH[244] Error is Occurred.
GROUP [0 - 1] - UNIT [0-1-4]	NE								CH[244] Error is Occurred.
GROUP [0 - 1] - UNIT [0-1-5]	NE								CH[244] Error is Occurred.
GROUP [0 - 1] - UNIT [0-1-6]	NE								CH[244] Error is Occurred.
GROUP [0 - 1] - UNIT [0-1-7]	NE								CH[244] Error is Occurred.
GROUP [0 - 1] - UNIT [0-1-8]	NE								CH[244] Error is Occurred.

The following information is displayed at the monitoring screen.

Item	Description
Air conditioner name	Name of air conditioner currently registered at the system.
Operation mode	Operation mode of set air conditioner.
Air flow	Air force of set air conditioner.
Air direction	Whether to set the air direction or not.
Lock all	Whether to set Lock All or not.

Item	Description
Temperature lock	Whether to set the temperature lock function or not.
Room temperature	The indoor temperature of the place where the current air conditioner is installed.
Desired temperature	The desired temperature to set the indoor temperature.
Start/Stop	The operation status of the air conditioner.
Remarks	The error code is displayed if the error is occurred. - Network Error (NE) - System Error (SE)

Reviewing the error history

The LG ACCS saves and records the information of the error occurred from all indoor units of the air conditioners connected to the ACP. You can see this error history at 'Error history' menu of the LG ACCS.

In order to view the error history of the air conditioner, click the 'Error history' menu at the top of the LG ACCS. When you click 'Error history' menu, the following error history screen is displayed.

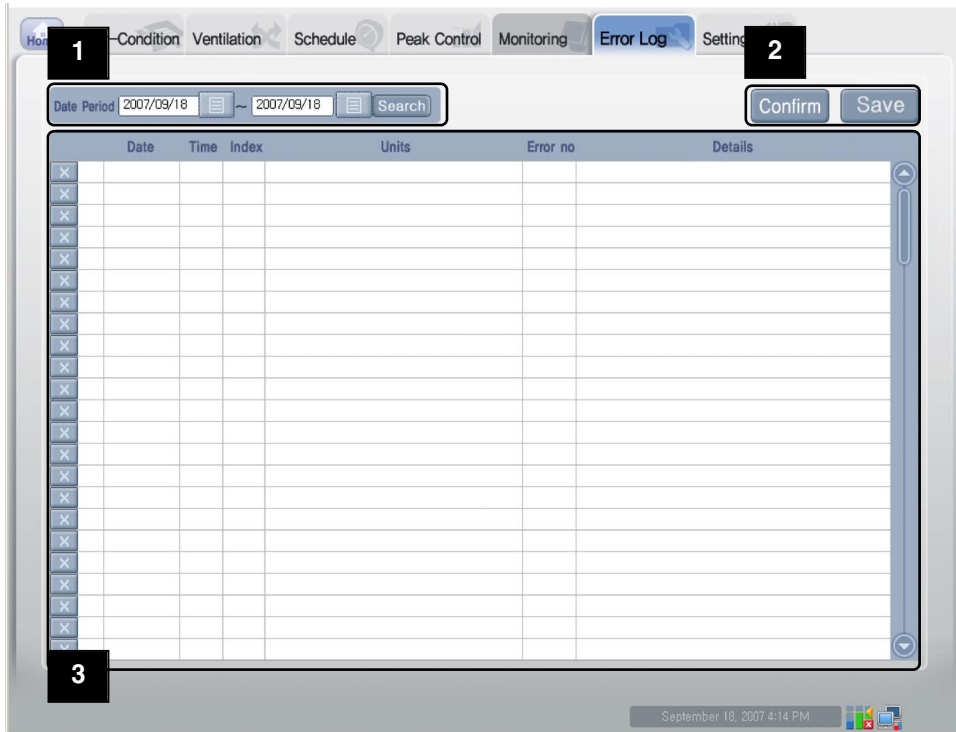

1 Querying the error history

Date Period ~

◀ 2007 SEP ▶

Sun	Mon	Tue	Wed	Thu	Fri	Sat
						1
2	3	4	5	6	7	8
9	10	11	12	13	14	15
16	17	18	19	20	21	22
23	24	25	26	27	28	29

You can set and query the information about the error occurred within the desired period. The start date and the end date of the period to query can be set by pressing each calendar button

() within the query period.

After setting the query period, when you click the [Query] button

(), the information about the error occurred within the period is displayed.

2 Saving and Printing



[Confirm to delete] button is used to safely delete the error displayed at the error history list within the system. After pressing button to delete the error displayed at the error history list, press [Confirm to delete] button to completely delete the related error within the ACP. If [Confirm to delete] button is not pressed after pressing button to delete the error, it is deleted from the current screen but it will be again displayed at the later error search.

When you press [Print] button, the queried error history can be saved as the file with the Excel format.

3 Error history list

Date	Time	Index	Units	Error no	Details
20070918	0000	0	grp[0] - UNIT [0-0-0]	242	Network Error is Occurred. : Receive Error
20070918	0000	1	grp[0] - UNIT [0-0-1]	242	Network Error is Occurred. : Receive Error
20070918	0000	2	grp[0] - UNIT [0-0-2]	242	Network Error is Occurred. : Receive Error
20070918	0000	3	grp[0] - UNIT [0-0-3]	242	Network Error is Occurred. : Receive Error
20070918	0000	4	grp[0] - UNIT [0-0-4]	242	Network Error is Occurred. : Receive Error
20070918	0000	5	grp[0] - UNIT [0-0-5]	242	Network Error is Occurred. : Receive Error
20070918	0000	6	grp[0] - UNIT [0-0-6]	242	Network Error is Occurred. : Receive Error
20070918	0000	7	grp[0] - UNIT [0-0-7]	242	Network Error is Occurred. : Receive Error
20070918	0000	8	grp[0] - UNIT [0-0-8]	242	Network Error is Occurred. : Receive Error
20070918	0000	9	grp[0] - UNIT [0-0-9]	242	Network Error is Occurred. : Receive Error
20070918	0000	10	grp[0] - UNIT [0-0-10]	242	Network Error is Occurred. : Receive Error
20070918	0000	11	grp[0] - UNIT [0-0-11]	242	Network Error is Occurred. : Receive Error
20070918	0000	12	grp[0] - UNIT [0-0-12]	242	Network Error is Occurred. : Receive Error
20070918	0000	13	grp[0] - UNIT [0-0-13]	242	Network Error is Occurred. : Receive Error
20070918	0000	14	grp[0] - UNIT [0-0-14]	242	Network Error is Occurred. : Receive Error
20070918	0000	15	grp[0] - UNIT [0-0-15]	242	Network Error is Occurred. : Receive Error

It displays the history list of the errors occurred within the query period.

Item	Description
Icon	The type of occurred error is displayed as icon.
	 Error occurred from the network.
	 Error occurred from the system (outdoor & indoor unit).
Date	Date when the error was occurred.
Time	Time when the error was occurred.
Index	Address of the indoor unit of air conditioner (the last digit of the physical address)
Air conditioner name	Name of group and air conditioner with the error occurred.
Error code	Code number for the occurred error.
Contents	Description for the occurred error.

Reviewing the wattage (interconnecting with the power display)

The LG ACCS offers the power display interconnection function to check and manage the wattage of all indoor units of the air conditioners connected to the ACP. If this function is used, when the outdoor unit is shared with office, residential-commercial building, and school, it can be effectively controlled because the wattage for each indoor unit is displayed.

Because the power display interconnection function remotely reads the wattage without the separate inspection program, it can easily check the wattage on which the billing can be done.

Caution: Power display interconnection



In order to use this function, the wattmeter should be interconnected with the PI385 connected to the ACP. For the power display interconnection function, the ACP and the wattmeter should be connected to the PI485 via the BUS. For more information about installing and using the wattmeter and the PI485, see the manual of the related product.

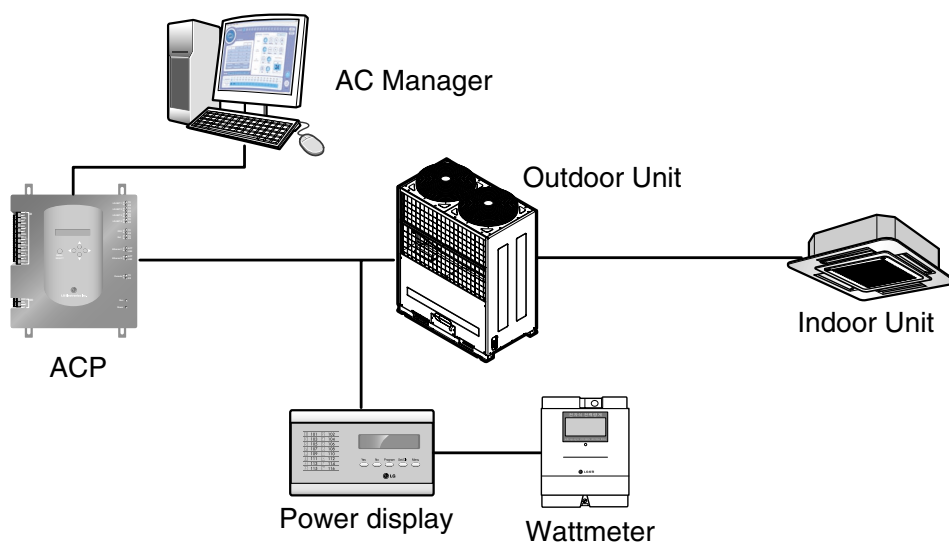

In order to use the power display interconnection function to check the wattage, click 'Wattage' menu at the top of the LG ACCS. When you click 'Wattage' menu, the following wattage screen is displayed.

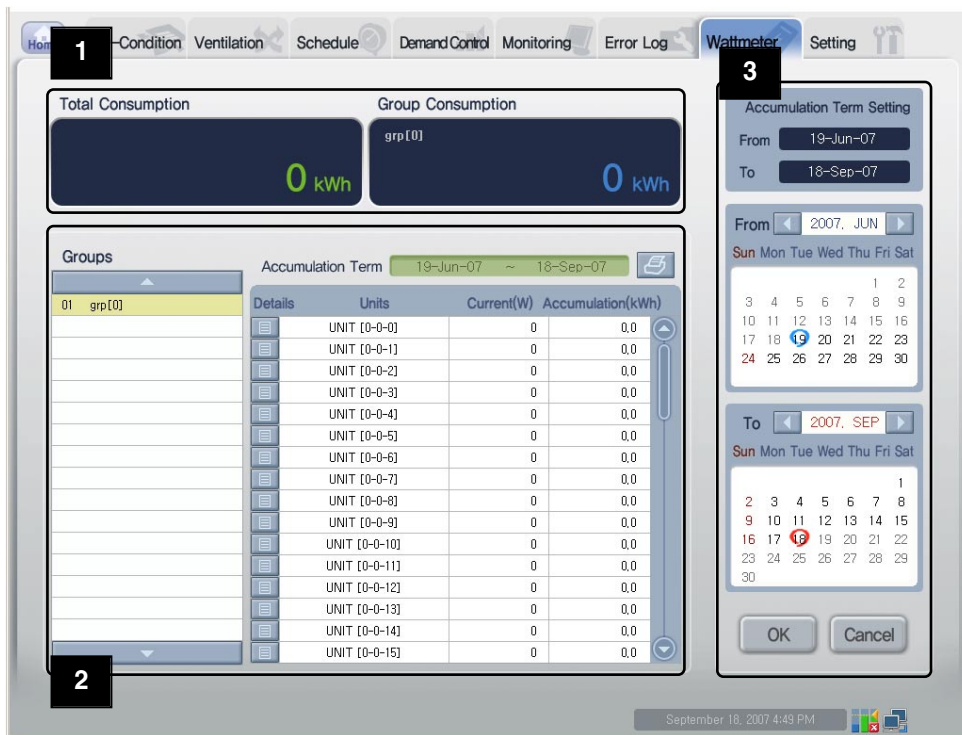

1 Wattage monitor

The wattage monitor displays the total wattage of the air conditioner groups connected to the ACP and the wattage for each group.

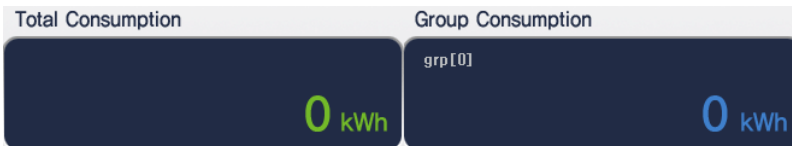

2 Wattage by group list

The wattage can be queried by group. The wattage within the specific period set by the user is classified and displayed by group.

'End' calendar



The end date of the query period can be set at 'End' calendar.

Apply & Cancel button

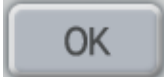

When you click [Apply] button after setting the query period, the wattage within the set query period is displayed at 'Wattage' screen.



When you click [Cancel] button, all settings up to now are cancelled and it returns to the previous screen.

Setting the system

For the following cases, the air conditioner or the ventilator should be registered at or deleted from the system by the LG ACCS.

- Installing the ACP for the first time
- Adding a new air conditioner or ventilator
- Changing the existing air conditioner or ventilator information
- Deleting the existing air conditioner or ventilator

The air conditioner can be registered or deleted at 'System setup' menu of the LG ACCS.

Caution: Setting the system



'System setup' menu is used for installing the product. Because the product should be installed by the professional engineer with knowledge about the air conditioner, the user should not operate this menu at random.

Caution: Interconnecting the ACP with the AC Manager



When the ACP is interconnected with the AC Manager, if the system is set by the LG ACCS of the ACP, it may cause the maloperation of the air conditioner. When interconnecting the ACP with the AC Manager, set the system by the AC Manager.

In order to register, delete or modify the air conditioner at the system, click 'System setup' menu of the LG ACCS. When you click 'System setup' menu, the following system setup screen is displayed.

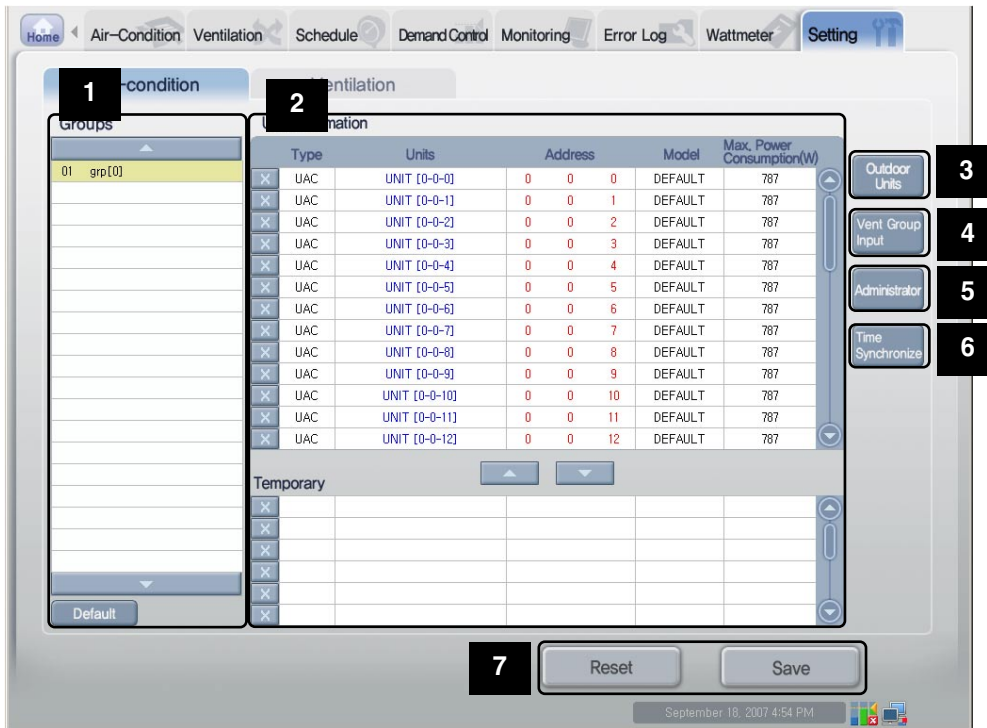

Note: Air conditioner setup and the ventilating setup

The air conditioner setup is almost same to the ventilating setup. Here, the system setup function is described based on the air conditioner setup.

2 Air conditioner (or ventilator) information input window and Temporary saving window

You can add, modify or delete the indoor unit or the ventilator.

Unit Information							
Type	Units	Address			Model	Max. Power Consumption(W)	
X	UAC	UNIT [0-0-0]	0	0	0	DEFAULT	787
X	UAC	UNIT [0-0-1]	0	0	1	DEFAULT	787
X	UAC	UNIT [0-0-2]	0	0	2	DEFAULT	787
X	UAC	UNIT [0-0-3]	0	0	3	DEFAULT	787
X	UAC	UNIT [0-0-4]	0	0	4	DEFAULT	787
X	UAC	UNIT [0-0-5]	0	0	5	DEFAULT	787
X	UAC	UNIT [0-0-6]	0	0	6	DEFAULT	787
X	UAC	UNIT [0-0-7]	0	0	7	DEFAULT	787
X	UAC	UNIT [0-0-8]	0	0	8	DEFAULT	787
X	UAC	UNIT [0-0-9]	0	0	9	DEFAULT	787
X	UAC	UNIT [0-0-10]	0	0	10	DEFAULT	787
X	UAC	UNIT [0-0-11]	0	0	11	DEFAULT	787
X	UAC	UNIT [0-0-12]	0	0	12	DEFAULT	787

Temporary							
X							
X							
X							
X							
X							
X							

Air conditioner information input

You can set a new indoor unit or ventilator information at this window.

First, in order to add a new indoor unit or ventilator, click the related input column. When it is changed to the yellow input window, enter the information of each item.

Modifying the existing indoor unit or ventilator is same. Click the information field of the indoor unit or ventilator to modify, and when it is changed to the yellow input window, modify the existing information.

In order to delete the existing indoor unit or ventilator information, click button located at the left side. The related information is deleted.

The information to set at the air conditioner (or ventilator) is as follows:

Item	Description
Type	Type of indoor unit or ventilator. The indoor unit types to set are as follows: <ul style="list-style-type: none"> • UAC: Unified air conditioner This item is not set for the ventilator.
Physical address	Enter the physical address of the indoor unit or the ventilator. When [Default input] button is pressed, it is automatically created by inheriting the higher information. The physical address consists of three numbers. The first number and the second number are the G/W number and the outdoor unit number respectively, which can be set only within the information entered from the existing [G/W information] and [outdoor unit information]. The third number is the indoor unit or ventilator number, which can not be set overlapped within the same outdoor unit number and should be set within the range of 0-15.
Model name	Enter the model name of the indoor unit or ventilator.
Maximum consumed power	Enter the maximum consumed power for the indoor unit or ventilator to use. The maximum consumed power depends on the model.

Caution: Maximum consumed power



Fi the peak/demand control function is used, the maximum consumed power for each indoor unit should be essentially entered. The consumed power of the air conditioner can be controlled not to exceed the setting value.



How to display the consumed power of indoor unit

Consumed power of the nth indoor unit

$$= \frac{(\text{Consumed power of outdoor unit} + \text{Total consumed power of indoor unit}) * \text{Consumed power of the nth indoor unit}}{\text{Total consumed power of indoor unit}}$$

Temporary saving window

It is convenient to use this window to move the indoor unit or the ventilator to the other group or to change the order.

After specifying the air conditioner or the ventilator, press  button to move it to the temporary saving window. Press  button to apply the temporarily saved air conditioner or ventilator again.

In order to delete the temporarily saved air conditioner or ventilator, click  button at the left side. The related information is deleted.















Caution: Maximum consumed power



When the system setting is saved, the temporarily saved information of the indoor unit or ventilator is deleted. So, the information of all air conditioners at the temporary saving window should be moved to the air conditioner information input window of each group before saving.

3 Entering the outdoor unit information



Outdoor Unit Setting						
G/W No.	Outdoor Unit No.	Outdoor Info	Type	Model	Max. Power Consumption(W)	
	0	0	OUTDOOR UNIT [0 - 0]	UAC	Default	9000
	0	7	OUTDOOR UNIT [0 - 7]	UAC	Default	9000
						
						
						
						
						
						
						
						
						
						
						
						
						

Default OK

Besides the information of the indoor unit and the ventilator, the outdoor unit information can be entered at 'System setup' menu.

When you click [Outdoor unit input] button located at the right side of the screen, the outdoor unit information input window is displayed.

First, in order to add a new outdoor unit, click the related input column. When the input window is changed to yellow, enter information of each item.

Modifying the existing indoor unit or ventilator is same. Click the information column of the indoor unit or ventilator to

modify, and when the input window is changed to yellow, modify the existing information.

In order to delete the existing air conditioner or ventilator information, click  button at the left side. The related information is deleted.

Caution: Deleting the outdoor unit

When the outdoor unit information is deleted, the information of the indoor unit connected the related outdoor unit is also deleted.

Item	Description
G/W Number	Leave as it is with not modified.
Outdoor unit number	Enter the outdoor unit number. It should not be set overlapped, which should be set as the number of 0~7. When [Default input] button is pressed, it is automatically created by inheriting the higher information.
Name	Enter the outdoor unit name for the user to easily recognize. (ex: 1st floor)
Type	Enter the type of the outdoor unit. The types to set are as follows: • UAC: Unified air conditioner
Model name	Enter the model name of the outdoor unit.
Maximum consumed power	Enter the maximum consumed power for the indoor unit or ventilator to use. The maximum consumed power depends on the model.

Note: Physical and Logical group

Each outdoor unit information is used as the information of physical group connecting the indoor unit.

However, the air conditioner group or the ventilating group is used as logical group information. The logical group information is used as the managerial aspect regardless to the physical connection. For example, at the school, even when air conditioners at the 1st grade classroom are connected to the different outdoor units, the user can create and manage the logical group '1st grade classroom' by editing the air conditioner group information.

4 Enter ventilator information

Vent Group
Input



You can enter the ventilator group information from the 'System setting' menu.

Group Number	Name
0	grp[0]

When you click on [Enter ventilator group] button located on the right side of the screen, ventilator group input window will be displayed.

First, to add a new ventilator group, you must click on the applicable input block. When the input window switches to yellow color, enter the information of each item.

Editing existing ventilators is applied in the same way. Click on the information block of the ventilator to edit and when it changes to yellow color, edit the existing information.

To delete the existing ventilator information, click on the X button located on the left side. The applicable information will be deleted.

Caution: Delete ventilator



When you delete the ventilator group information, the ventilator information included in the applicable ventilator group will all be deleted.

Information to center to set the ventilator group is as follows.

Item	Description
Group number	Enter the ventilator group number. The ventilator group number must not be duplicated and must be set within the range of 0~7. When you press the [Enter default value] button, you can easily create the number by receiving the higher level information.
Name	Enter the name of the ventilator group that the user can easily recognize. (Example. 1 floor)

5 Entering the administrator information

A window titled "Administrator" with a table for entering user information. The table has two columns: "ID" and "PW". There are 12 rows, each with a small "x" icon in the left margin. Below the table are three buttons: "Save", "Cancel", and "A/S".

	ID	PW
x		
x		
x		
x		
x		
x		
x		
x		
x		
x		
x		
x		

The administrator information can be entered at 'System setup' menu. The administrator information is the right to log in to the LG ACCS.

When you click [Administrator information] at the right side of the screen, the IP/PW input window is displayed.

Enter the ID for the user to access at the 'ID' field and set the user's password at the 'PW' field, and then click [Save] button to save the setting information of the ID and the password.

Click [Cancel] button to cancel without saving the setting value.

The [A/S] button is not used at present. It will be updated later.

6 Time synchronization button



[Time synchronization] button aligns (synchronizes) the time of the user's PC with the system time of ACP. The schedule function of ACP must be executed at accurate time according user setting. If you are operating ACP for the first time or when the time set for ACP is not accurate during use, click on the [Time synchronization] button to synchronize the time between the user PC and ACP.

7 Last save state button & Save button

[Last save state] button and [Save] button to set whether to apply the setting to the system or not are located at the bottom of the 'System setup' menu.

Last save state button



Click [Last save state] button not to change the information.

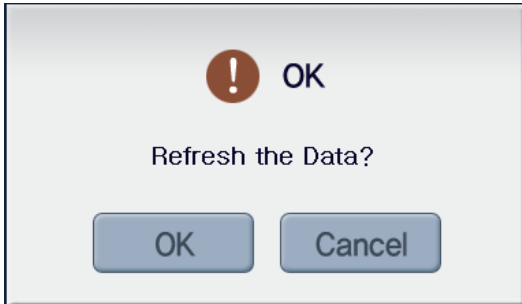

When you click [Last save state] button, the window for confirming to execute the command is displayed, and when you click [Confirm] button, all information set up to now is cancelled and it returns to the previous save state.

Caution: Deleting the indoor unit information



When you click [Confirm] button at the confirmation window, the not saved information of the setting up to now is returned to the last save status, so be careful.

Save button



Click [Save] button to change the information.

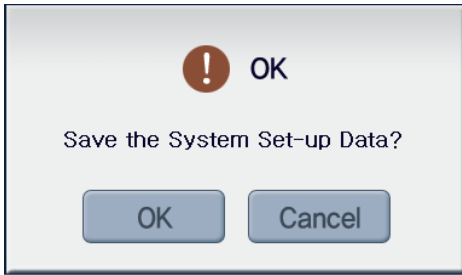

When you click [Save] button, the window for confirming to execute the command is displayed. Click [Confirm] button to confirm the command. Click [Cancel] button to cancel the command and return to the previous condition.

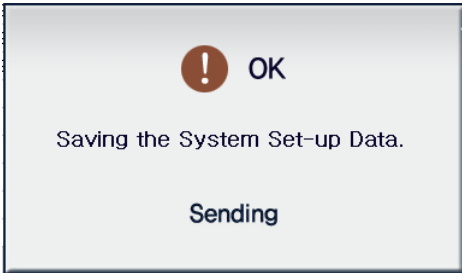

When you click [Confirm] button, all information set up to now is saved and the saving process is informed to the user by the confirmation window.

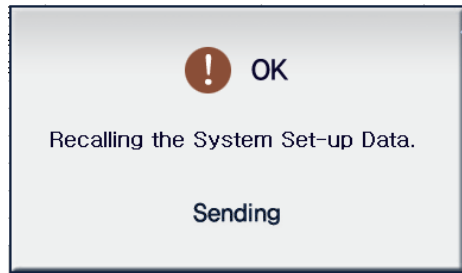

Caution: Initializing the information of other functions



When saving is done at 'System setup' menu, all existing information such as schedule, peak operation ratio control (peak excluded air conditioner) and error log are initialized.

Note: Procedure for setting the system (air conditioner and ventilator)

1. Click [Air conditioner setup] tab, and then click [Outdoor unit input] button at the right side of the screen. When you click [Default input] button at the 'Outdoor unit information input' window, the outdoor unit information (group number) is entered as default. And then, delete the number of the not-installed outdoor unit (group number), and modify the outdoor unit name for the user to easily know.
2. Press [Air conditioner setup] tab, and then press [Default input] button at the bottom left of the screen. The indoor unit information is entered as default. And then, delete the number of the not-installed indoor unit, and modify the indoor unit name for the user to easily know.
3. Click [Ventilating setup] tab, and then click [Outdoor unit input] button at the right side of the screen. When you click [Default input] button at the 'Outdoor unit information input' window, the outdoor unit information (group number) is entered as default. And then, delete the number of the not-installed outdoor unit (group number), and modify the outdoor unit name for the user to easily know.
4. Press [Ventilating setup] tab, and then press [Default input] button at the bottom left of the screen. The group number of the ventilator is entered as default. And then, delete the number of the not-installed ventilator, and modify the ventilator name for the user to easily know. Especially, because the physical address may be incorrectly entered when it is entered at the connection of the ventilator, the ventilator should be set according to the setting order.

For more information, see Chapter 2. 'Entering the Indoor unit & Ventilator information.'

4. Reference

Troubleshooting

If any unexpected problem is occurred when using the ACP, see the following list to find out the solution. If there is no solution to find, visit <http://www.lgservice.com> to let us know about it.

If Tx or RX LED of Ports 1~4 of the EE-NET is not blinking when installing the product.

When installing the product, if TX or RX LED of the ports 1~4 of the LG-NET is not blinking, set and execute the group of the indoor/outdoor unit.

If the GUI of the EE ACCS, the application program of the ACP, does not operate

If the GUI of the EE ACCS, the application program of the ACP, does not operate, close the Explorer window and execute a new Explorer to connect again.

When network error status (Code 242) is displayed on ventilator in LG ACCS of ACP

When the network error status is continuously displayed on the ventilator as shown below through LG ACCS, the web server program of ACP, check the following details.

1. Check whether the BUS_A and BUS_B of RS485 cable are connected incorrectly.
2. Check whether there is any communication error between the remote controller and indoor unit.
3. Check whether the DIP switch of PI485 is set incorrectly.
4. Check whether the indoor unit address of the central control is not set up.

Guide for Open source software

The following GPL/LGPL execution files and libraries used at this product conform to the GPL/LGPL license contract.

GPL execution file

Linux kernel 2.4	fdisk	lrzsz
Sysvinit	Inetutils	e2fsprogs
Bash	net-tools	boa http server
busybox	stupid-ftpd	
tinylogin	traceroute	

EEPL library

glibc	linuxthreads	ncurses	zlib

If you request the source code to the EE electronics via the following e-mail, you can receive the CD-ROM containing it by paying the cost including media cost and transportation cost.

da_opensource@lge.com

This proposal is valid for three years after receiving this product from the EE electronics.

The source of the GPL/LGPL license can be downloaded at <http://www.systemaircon.com>

Some of softwares used at this product conform to the following copyright.

Copyright ©1998-2002 Daniel Veillard. All Rights Reserved

UTP cable connection chart

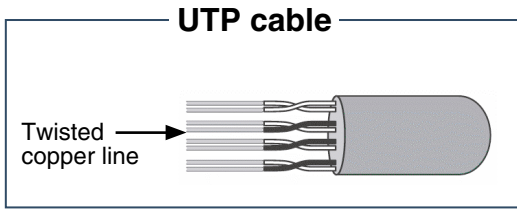

The Unshielded Twisted Pair (UTP) cable is a sort of the signal line connecting the LAN environment. Two copper lines insulated for reducing the electromagnetic induction between two lines are twisted to form the twisted pair.

The UTP cable consists of 8 wires, of which four lines (No. 1 and 2 for receiving (Rx) and No. 3 and 6 for transmitting (Tx)) are actually used for the data transmission at the general LAN environment. It can be largely classified two types according to the method for connecting the line for receiving and transmitting.

Direct cable

It is also called the 1:1 straight cable used for connecting the other equipment at the network.

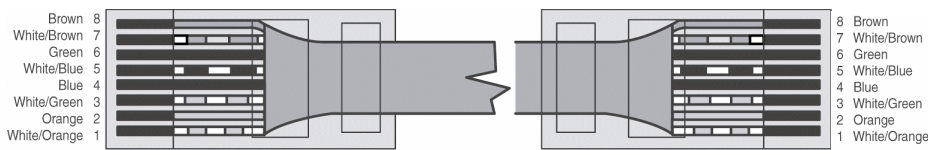

Cross cable

It is used for the 1:1 connection between the same equipments at the network.

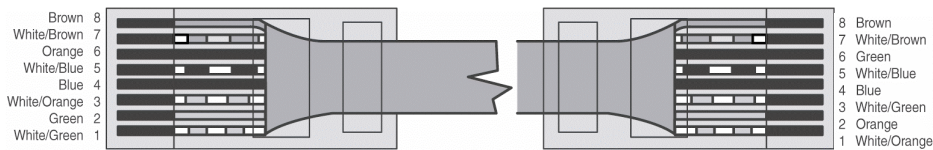



P/No.: MFL37115820

Printed in Korea

After reading this manual, keep it in a place easily accessible to the user for future reference.