

This Owner's Manual is provided and hosted by [Appliance Factory Parts](#).

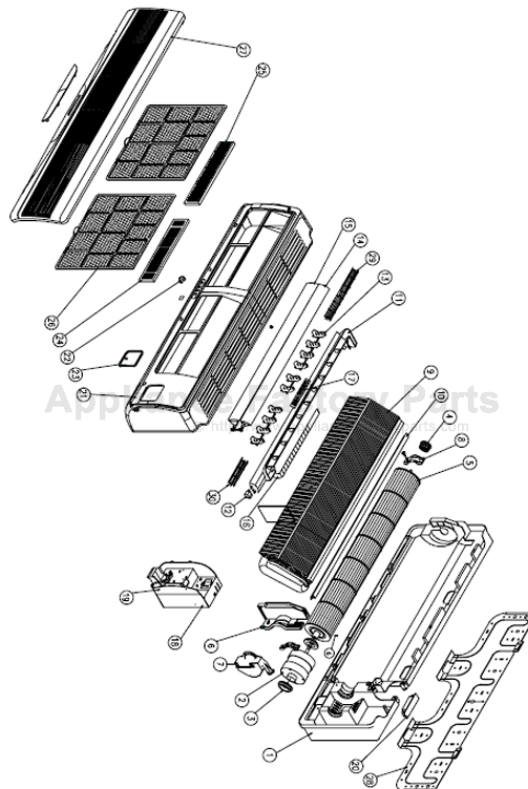

TURBO AIR TAS-24 Owner's Manual

[Shop genuine replacement parts for TURBO AIR
TAS-24](#)



[Find Your TURBO AIR Air Conditioner Parts - Select From 72 Models](#)

----- Manual continues below -----

SAFETY INSTRUCTIONS

PLEASE READ THE FOLLOWING SAFETY INSTRUCTIONS BEFORE INSTALLING AND OPERATING THE UNIT:

This air conditioner meets strict safety and operating standards. The installer of this unit must install or service this unit so it operates safely and efficiently.

IMPORTANT NOTES

- Adhere to all safety instructions and warnings throughout this manual.
- Read this manual carefully before installing or operating this unit to become familiar with its features and obtain the performance that will bring you continued enjoyment for many years.
- Follow each installation or repair step exactly as shown in the manual.
- Observe all local, state and national electric codes. Contact your local government for more information on electrical codes.



The lightning flash with the arrowhead symbol, within an equilateral triangle is intended to alert the user of the presence of uninsulated dangerous voltage within the product's enclosure that may be of sufficient magnitude to constitute a risk of electric shock to persons.



The exclamation point within an equilateral triangle is intended to alert the user to the presence of important operating and maintenance (servicing) instructions in the literature accompanying the appliance.

Contact Installer if Necessary:

The installation instructions are for a experienced installer. If you are not an experienced installer, contact a local installer for help. If you require help with service, contact your certified dealer or Turbo-Air Inc. for additional instructions.

If Unit is Installed Improperly:

The manufacturer shall in no way be responsible for improper installation or maintenance service, including failure to follow the instructions in this manual.

WARNING:

- ELECTRICAL SHOCK CAN CAUSE SEVERE PERSONAL INJURY OR DEATH. ONLY A QUALIFIED, EXPERIENCED ELECTRICIAN/INSTALLER SHOULD ATTEMPT TO WIRE THIS SYSTEM.
- THE APPLIANCE IS NOT INTENDED FOR USE BY CHILD OR INFIRM PERSONS WITHOUT SUPERVISION.
- YOUNG CHILDREN SHOULD BE SUPERVISED TO ENSURE THAT THEY DO NOT PLAY WITH THE APPLIANCE

Precautions When Wiring:

- Do not plug in the unit until all connections (tubing, drain hose, mounting, etc.) have been made and double-checked.
- High voltages are present in this unit and are very dangerous. Please refer to these instructions and diagrams when wiring. Improper connections or inadequate grounding can cause accidental injury.
- This unit must be grounded in accordance with local electrical codes.
- Connect wires and pipes securely and tightly as loose connections/wiring may cause overheating at connections and a possible fire hazard.

Precautions When Transporting:

- When transporting the unit, be very careful and get help because the units are heavy. Be careful of sharp edges on the units also.

Precautions When Installing:

- **When installing in a ceiling or wall**, make sure the ceiling/wall is strong enough to hold the unit's weight. A frame may be necessary for added support.
- **When installing in a room**, make sure the tubes become well insulated to protect the walls and furniture from sweating of the tubes.
- **When installing in moist or uneven locations**, make sure to use a raised level concrete pad or concrete blocks to provide a level, solid foundation for the outdoor unit; this prevents water damage and vibration.
- **When installing in an area of high winds**, make sure to securely anchor the outdoor unit down with bolts and a metal frame.

When Connecting Refrigerant Tubing:

- Keep all tubing as short as possible.
- Use the flare method for connecting tubing.
- Apply refrigerant lubricant to the matching surfaces of the flare and union tubes before connecting them, then tighten, making sure not to overtighten.
- Check the tubes carefully for leaks before starting the test run.

When Servicing:

- Make sure the power is off and the unit is unplugged before opening the unit to troubleshoot or repair electrical parts and wiring.
- Keep your fingers and clothing away from any moving parts.
- Clean up the sight after you finish, making sure no metal scraps and wiring are left in the unit.
- The Air conditioner shall be installed in accordance with the national wiring regulation.
- The equipment fulfills the requirements in EN 61 000-3-11 and is subject to conditional connection to the mains.
- It may be connected in consultation with the supply authority.
- The equipment may only be connected to a mains supply with a system impedance of less than 0.3 ohm.
- The system impedance in the interface point may be obtained from the supply authority.
- If the mains supply has a higher system impedance, short voltage dips may appear when the equipment is started or during operation.
- This may influence or disturb the operation of other apparatuses, e.g. flickering lamps, especially those connected to the same supply mains.

ROOM AIR CONDITIONER INSTRUCTION

Remark per EMC Directive 89/336/EEC

To prevent flicker impressions during the start of the compressor (technical process) following installation conditions do apply:

1. The power connection for the air conditioner has to be done at the main power distribution. This distribution has to be of an low impedance. Normally, the required impedance is reached at a 32A fusing point. Air conditioner fuse has to be 16A max!
2. No other equipment has to be connected to this power line.
3. For detailed installation acceptance, please refer to your contract with the power supplier.
If restrictions do apply for products like washing machines, air conditioners or electrical ovens.
4. For power details of the air conditioner refer to the rating plate of the product.

CONSIGNES D'INSTALLATION RACCORDEMENT ELECTRIQUE

Remarques relatives à la Directive EMC 89/336/CEE

Pour éviter les phénomènes de scintillements (variation de lumière) et les parasites lors du démarrage du compresseur, respecter les consignes d'installation décrites dans le mode d'emploi.

1. Le raccordement au secteur doit être fait à l'aide d'un câble de section suffisante pour éviter tout échauffement de celui-ci et les chutes de tension (section recommandée 3x4mm²)
Cette ligne doit être protégée par un fusible ou disjoncteur de 16A
2. Aucun autre appareil ne doit être connecté sur cette ligne.
3. En cas de doute ou de difficulté contactez votre agence EDF. Vérifiez qu'il n'existe pas de contraintes particulières pour l'installation et l'utilisation de ce climatiseur.
4. Pour les caractéristiques de l'appareil référez vous à sa plaque signalétique.

ISTRUCCIONES DE INSTALACION DEL AIRE ACONDICIONADO

Comentario de la Directiva 89/336 EEC de la EMC.

Para prevenir la sensación de golpeteo al arrancar el compresor (proceso técnico) debe aplicar las siguientes instrucciones de instalación

1. La conexión del aire acondicionado a la corriente eléctrica tiene que ser hecha a la distribución principal de energía. Esta distribución tiene que ser de baja impedancia. Normalmente, la impedancia requerida se alcanza en el punto de fusión de 32A. El fusible del aire acondicionado tiene que ser de 16A máximo.
2. Ningún otro equipo debe ser conectado a esta línea eléctrica.
3. Para normas detalladas de instalación por favor consulte el contrato con su suministrador eléctrico, si tiene que aplicar restricciones para productos como lavadoras, aire acondicionado u otros eléctricos.
4. Para detalles sobre la alimentación eléctrica del aire acondicionado consulte la placa de datos del aparato.

ANWEISUNGEN ZUR INSTALLATION DER RAUM-KLIMAANLAGE

Hinweis entsprechend EMV-Direktive 89/336/EEC

Um einen "Flicker-Effekt" beim Anlauf des Kompressors (kurzzeitiger Spannungseinbruch, technischer Vorgang) zu vermeiden, muß für folgende Installationsbedingungen gesorgt sein. (siehe auch "Anweisungen zur Installation.")

1. Der Stromanschluß für die Klimaanlage muß am Hauptverteiler vorgenommen werden. Die Abzweigung muß mit niedriger Impedanz ausgeführt werden. Normalerweise ist die erforderliche niedrige Impedanz bei einem Sicherungsanschlußpunkt von 32A erreicht.
2. An die gleiche Netzleitung dürfen keine anderen Geräte angeschlossen sein.
3. Seitens der lokalen Energieversorgungsunternehmen bestehen möglicherweise Einschränkungen für Produkte wie Waschmaschinen, Klimaanlage, elektrische Öfen, etc. Für Einzelheiten zur Installation sehen Sie in Ihren Vertrag mit dem Energieversorgungsunternehmen.
4. Einzelheiten über die elektrischen Daten der Klimaanlage ersehen Sie auf dem Typenschild des Gerätes.

ISTRUZIONI PER L'INSTALLAZIONE DEL CONDIZIONATORE D'ARIA PER STANZE

NOTA DELLA DIRETTIVA EMC 89/336 EEC

Allo scopo di prevenire l'effetto di FLICKER (variazione della luce) alla partenza del compressore, durante l'installazione seguire i punti sottoelencati.

1. Il collegamento dell'alimentazione, del condizionatore, deve essere fatto con una linea preferenziale direttamente al quadro principale o contatore, e deve essere a bassa impedenza.
Normalmente questa impedenza la si ottiene al punto di fusione di 32 A; per il condizionatore usare un fusibile da 16 A max.
2. Nessun altro apparecchio elettrico dovrà essere collegato alla stessa linea di alimentazione.
3. Per maggiori dettagli circa l'accettazione dell'installazione del condizionatore, fare riferimento al contratto con l'Ente erogatore dell'Energia Elettrica e verificare che non ci siano restrizioni in atto all'installazione di prodotti elettrici ad alto consumo.
4. Per le informazioni relative ai dati di alimentazione del condizionatore, fare riferimento all'etichetta posta sul prodotto.

CONTENTS

It is recommended that you read the Operating instructions fully before operating this unit.

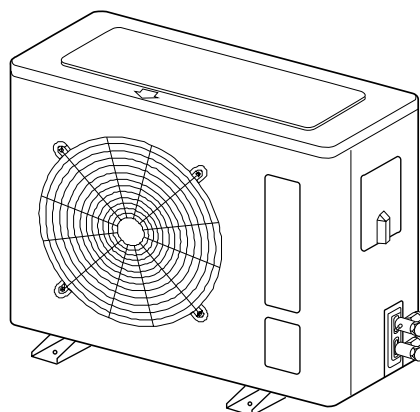
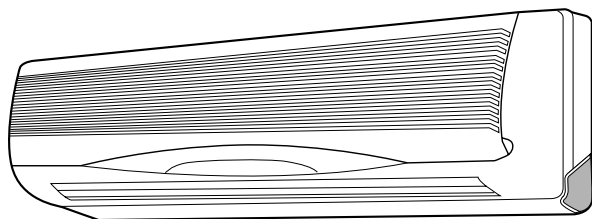

Safety Instructions	1
Contents	3
Location of Controls	4
Indoor Unit	4
Outdoor Unit	4
Indoor Unit Display	5
Remote Controller	7
Remote Display	7
Operation	9
Connecting the Cable	9
How to Install Batteries	9
Setting the Unit for Remote Operation	10
To Set Auto Mode	10
To Set Quick Mode	10
To Set Cool Mode	11
To Set Fan Only Mode	11
To Set Dehumidifier Mode	12
To Set Unit to Heat Mode	12
To Select The Fan Direction	13
To Set On Timer Mode	13
To Set Off Timer Mode	14
To Set Unit to Sleep Mode	14
To Set Turbo/Mild Mode	14
Emergency Operation	15
Changing/Cleaning the Air Filters	16
Cleaning the Indoor Cover	17
Care and Maintenance	18
Troubleshooting Guide	19
Instruction of Installation	20

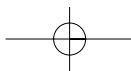

LOCATION OF CONTROLS

INDOOR UNIT

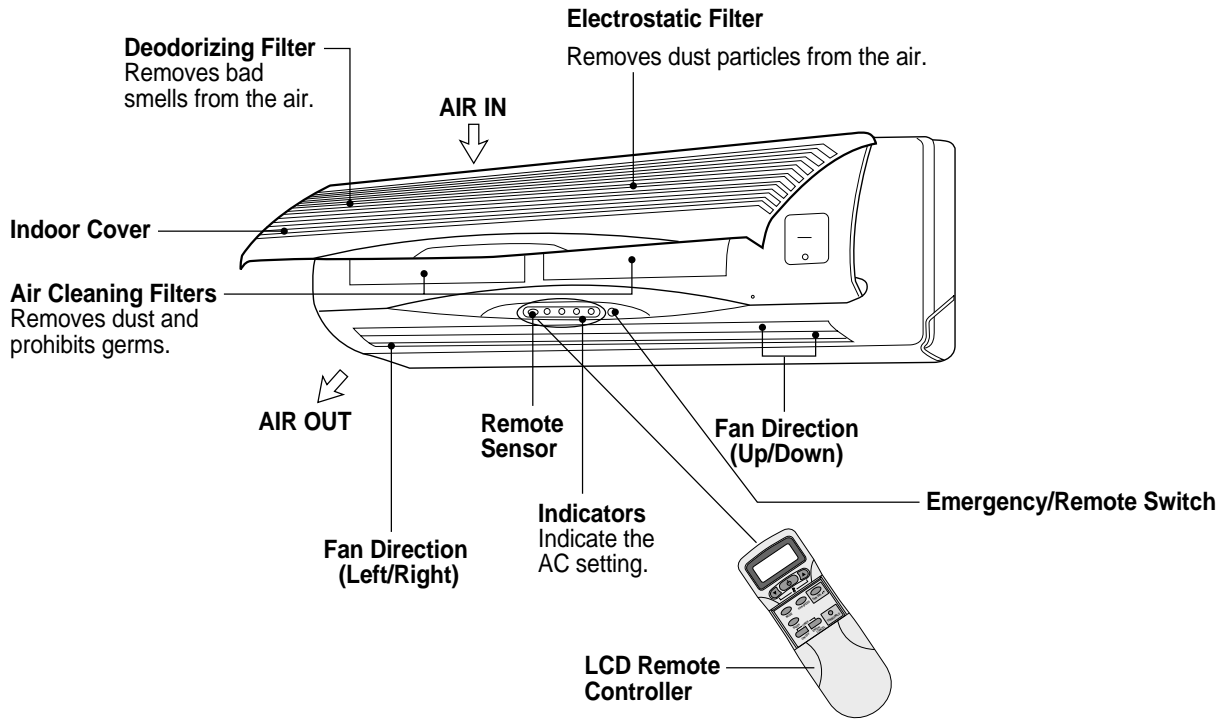

OUTDOOR UNIT

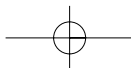
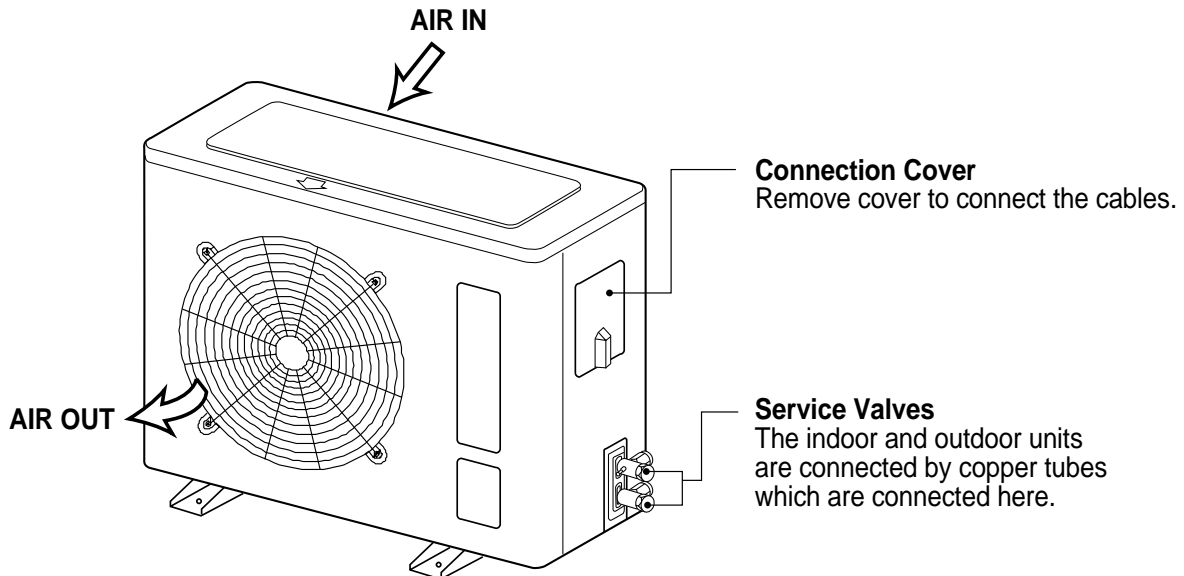

INDOOR UNIT DISPLAY (TAS-12/18/24/12H(O)/18H(O)/24H(O))

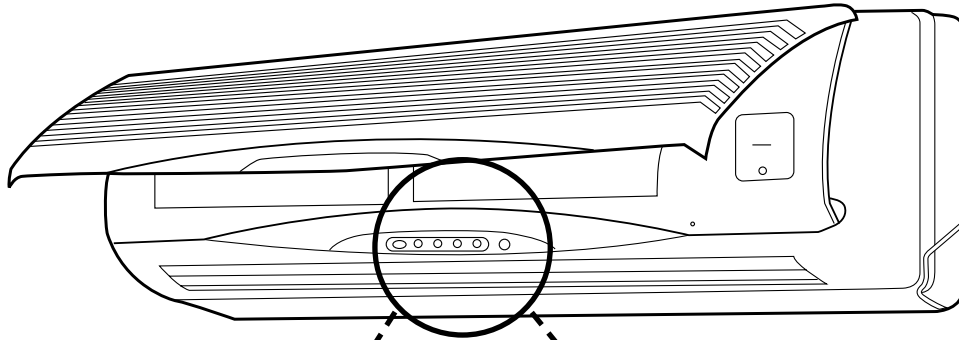

Indoor Unit Display

■ Remote Control Signal Receiver

This place is the part to receive the signal if it receives the signal, you can hear the signal "beep, beep".



ON (Red)
Lights when the operation is going on.

Air clean (Green)

Quick (Red)
Lights during the time Quick Mode.

Timer (Yellow)
Lights during the time reservation mode.

Switch Panel

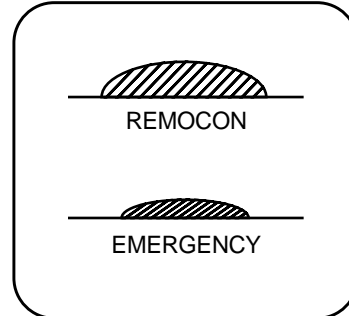

■ There is a switch panel at the inside of the Front Panel. At the time of operating, open the Front Panel.

Emergency switch can be used when the remote controller is lost or testing.

Remote switch is usually used by remote controller.

INDOOR UNIT DISPLAY (TAS-15/15H)

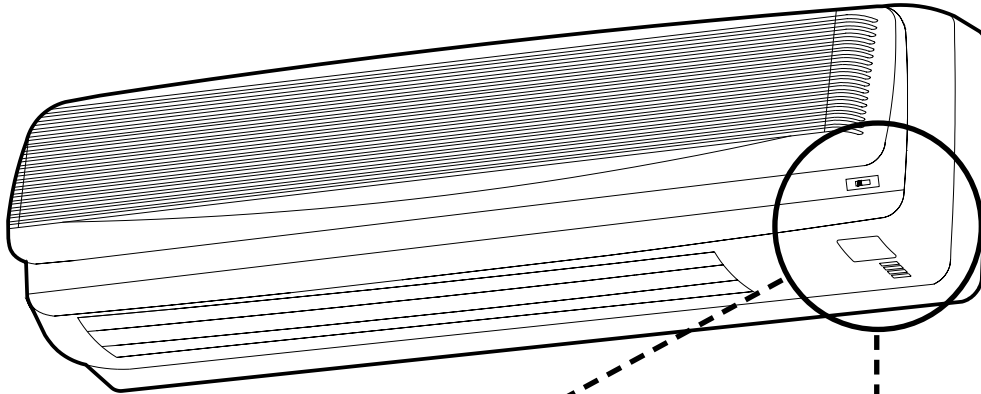

Indoor Unit Display

Remote Control Signal Receiver

This place is the part to receive the signal if it receives the signal, you can hear the signal "beep-beep".

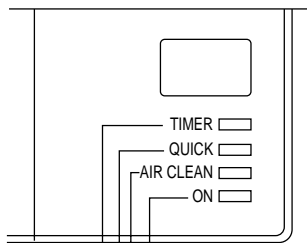

Timer (Yellow)
Light-on during the time of reservation mode.

Quick (Red)
Light-on during the time of Quick Mode.

ON (Red)
Light-on during the operation

Air clean (Green)
Light-on during the operation

Switch Panel

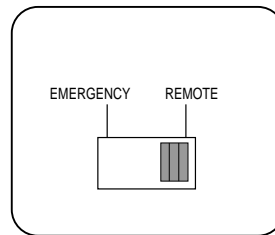

■ **When the remote controller is lost or out-of-order, put the switch on the EMERGENCY to operate by hand.**

Open the front panel on emergency operating.

Remote mode is used with remote controller.

REMOTE CONTROLLER (TAS-12/15/18/24)

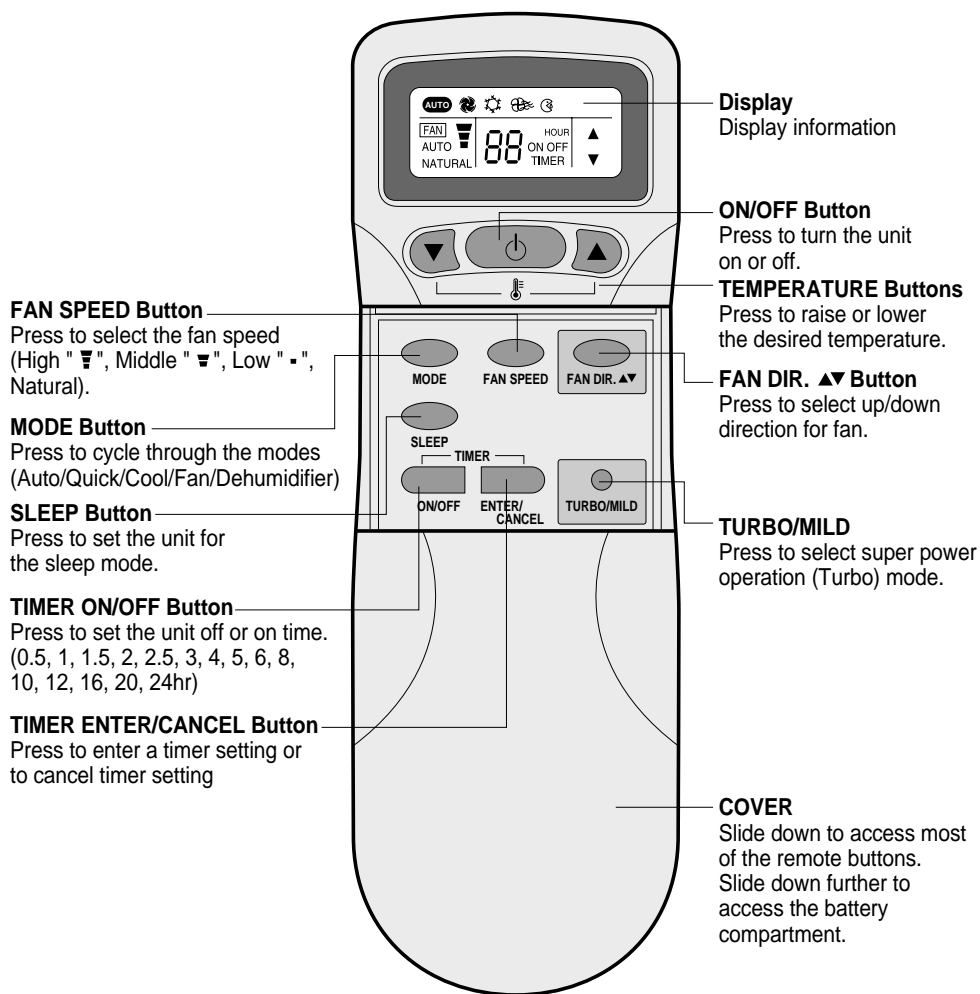

REMOTE DISPLAY

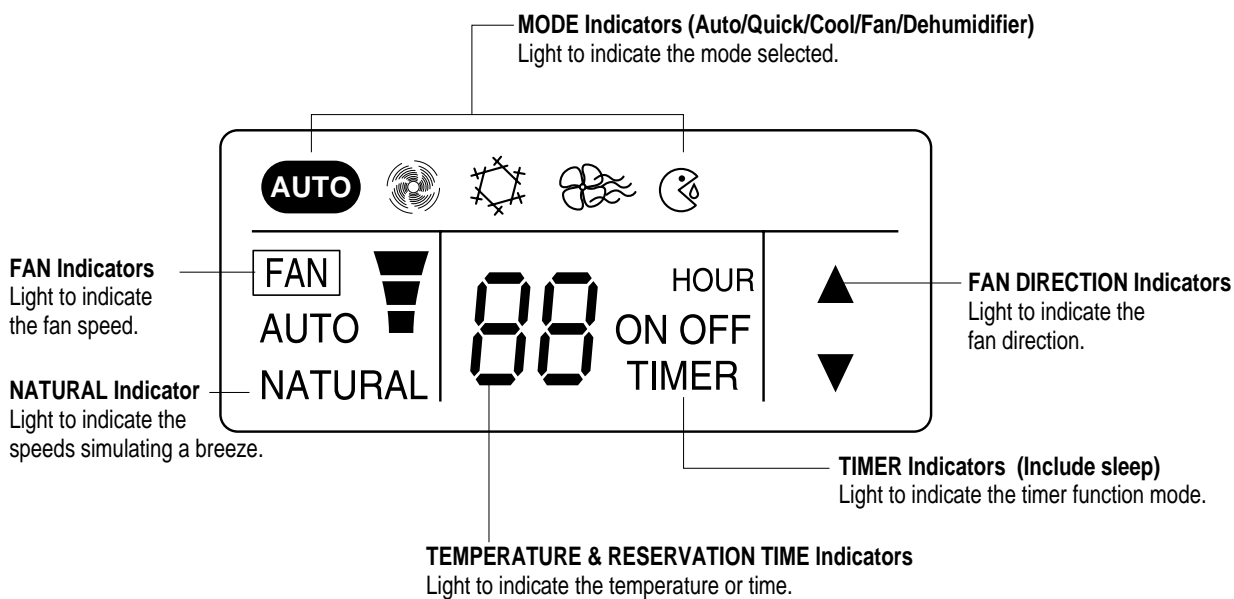

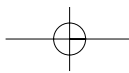

REMOTE CONTROLLER (TAS-12H(O)/15H(O)/18H(O)/24H(O))

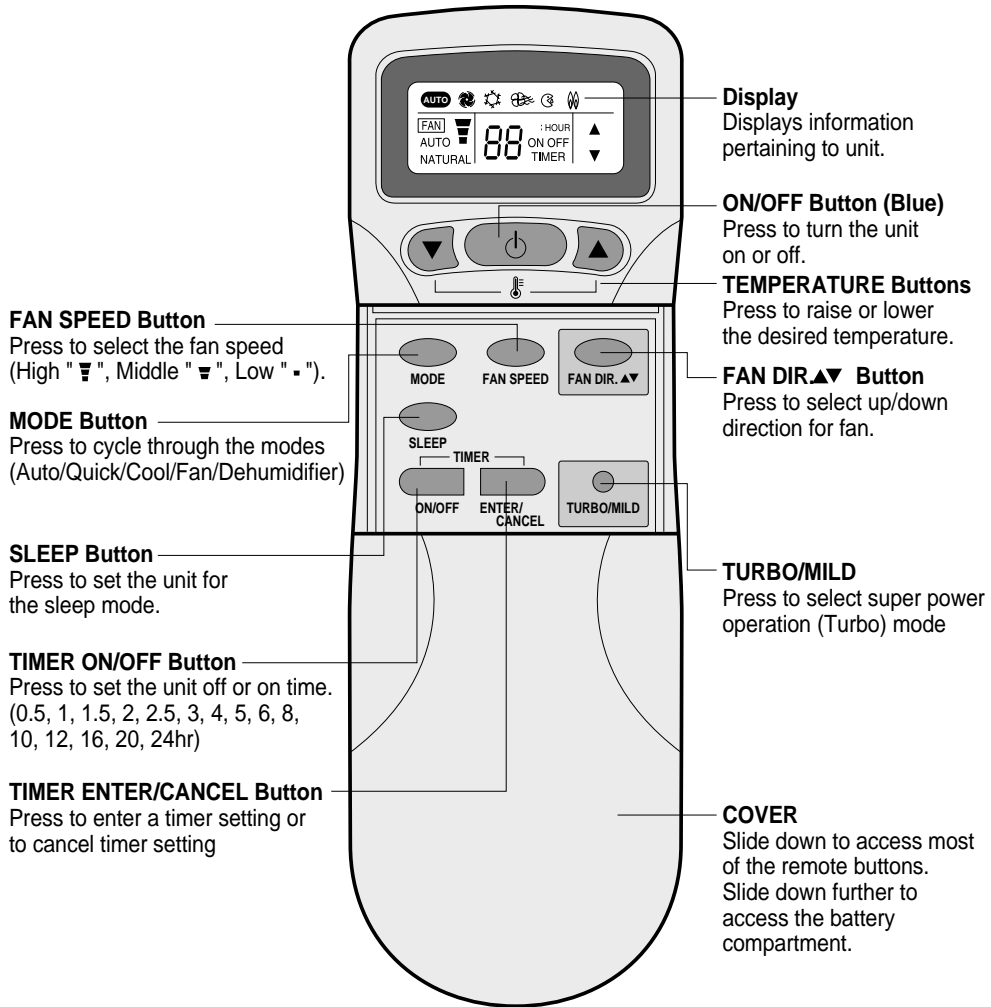

REMOTE DISPLAY

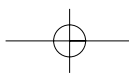
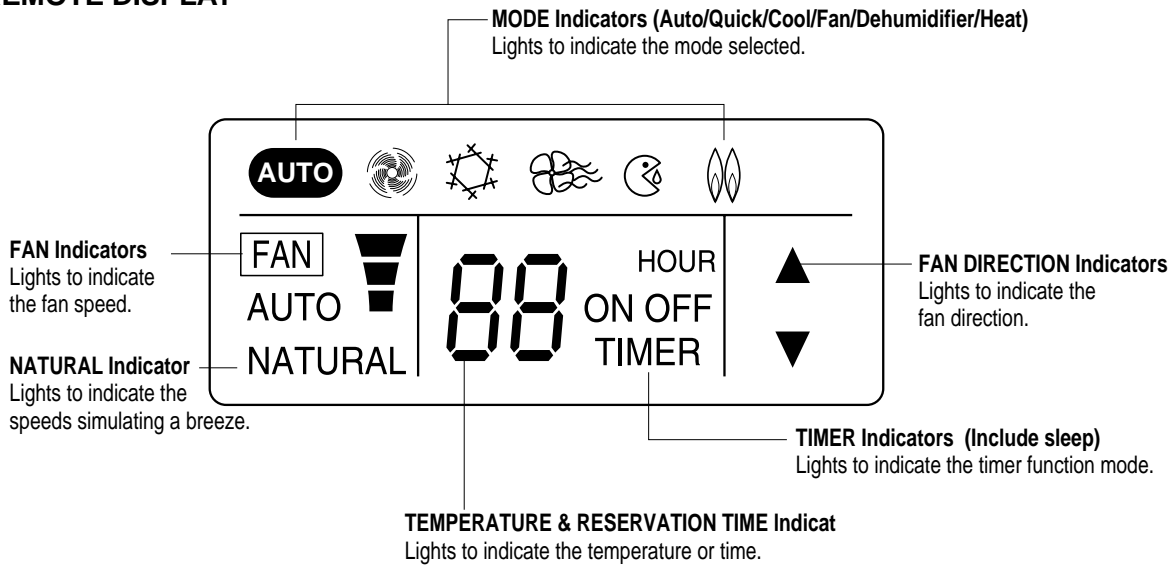

OPERATION

CONNECTING THE CABLE

One electric power cable must be connected to the outdoor unit. The indoor unit is connected to outdoor unit through the connection cable.

1. Remove the Service Cover on the side of the outdoor.
2. Connect the connection cable to terminal blocks of the indoor and outdoor unit.
 - Must be connected with the same terminal number of indoor and outdoor unit.
3. Connect the earth wires to the earth terminal.
4. Reinstall the service cover.

NOTE:

- The supply voltage must be the same as the rated voltage of the air conditioner.
- Prepare the power source for exclusive use with the air conditioner.
- A circuit breaker must be installed between the power source and the unit.

INFORMATION

- When you install or service this air conditioner, contact an authorized electrician or specialist.
- This air conditioner must be installed according to the national electric rules.
- The information for this air conditioner is as below.

ITEM	SPECIFICATIONS	
POWER CABLE	12K~15K BTU/h	3G AWG 14 SJT or SPT-3
	18K~24K BTU/h	3G AWG 12 SJT or SPT-3
CONNECTION CABLE	12K~24K BTU/h	5G AWG 16~18 SJT 3G AWG 18~20 SJT+2G AWG 16~18 SJT
	CONDUIT SIZE	0.875 inch (22.2mm)

HOW TO INSTALL BATTERIES

To install the batteries, follow the procedures below:

1. Slide the cover down to access most of the remote buttons. Slide down further to access the battery compartment.

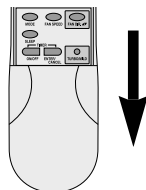

2. Insert two "AAA" size Alkaline batteries following the polarity diagram below.

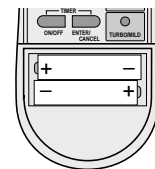

BATTERY PRECAUTIONS

The precautions below should be followed when using batteries in this device:

1. Use only the size and type of batteries specified.
2. Be sure to follow the correct polarity when installing the batteries as indicated in the battery compartment. Reversed batteries may cause damage to the device.
3. Do not mix different types of batteries together (e.g. Alkaline and Carbon-zinc) or old batteries with fresh ones.
4. If the device is not to be used for a long period of time, remove the batteries to prevent damage or injury from possible battery leakage.
5. Do not try to recharge batteries not intended to be recharged; they can overheat and rupture. (Follow battery manufacturer's directions).

- NOTES:**
- When operating the remote controller, make sure there are no obstructions between the remote controller and the remote sensor.
 - After a while the display goes blank to conserve battery power. To check the settings, press the ON/OFF button once.

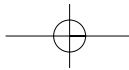

SETTING THE UNIT FOR REMOTE OPERATION

After the unit is fully connected and plugged in, it can be turned on. To turn the unit on and set it for remote operation, follow the procedures below:

1. Open the indoor unit's cover and make sure the EMERGENCY/REMOTE switch is set to the REMOTE position; this will allow the unit to operate with the remote controller.

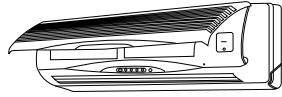

EMERGENCY/REMOTE Switch

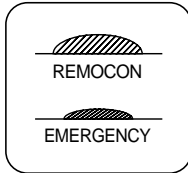

2. Press the ON/OFF button on the remote controller to turn on the unit. The On LED will light on the indoor unit and "ON" will light in the remote display. To select the various modes and settings, read the following pages.



THREE MINUTE COMPRESSOR DELAY

- After turning the indoor unit on and setting it for air conditioner operation, the compressor (outdoor unit) will not come on for three minutes. This is a feature that will protect the compressor from damage due to quick starts and stops.

TO SET AUTO MODE

This unit will automatically operate the unit according to its surroundings while in the Auto mode. All you have to set is the desired temperature and it will control the fan, coolness and dehumidifier. Follow procedures below:

1. Press the ON/OFF button on the remote control to turn the unit on; the On LED will light on the indoor unit and "ON" will light in the remote display.

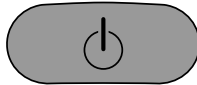

2. Make sure the AUTO indicator **AUTO** appears in the remote display. Using the TEMP. or buttons, set the desired temperature. The desired temperature can be changed up or down 1 degree from the actual room temperature. For temperature setting: 74~82°F



3. Then the unit will automatically operate.

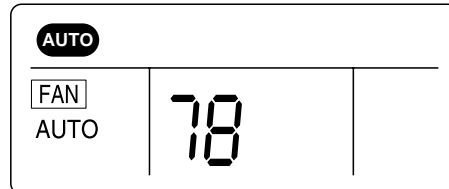

TO SET QUICK MODE

To set this unit to cool at the highest power, follow the procedures below:

1. Press the ON/OFF button on the remote control to turn the unit on; the On LED will light on the indoor unit and "ON" will light in the remote display.

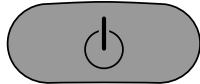

2. Press the MODE button until the Quick indicator appears in the display.

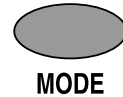

3. The unit will then start cooling the room at the highest power.

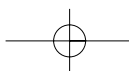

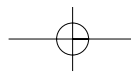



TO SET COOL MODE

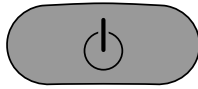

To set the unit to cool the room to a desired temperature, follow the procedures below:

1. Press the ON/OFF button on the remote control to turn the unit on; the On LED will light on the indoor unit and "ON" will light in the remote display.

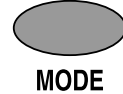

2. Press the MODE button until the Cool indicator  appears in the display.



3. Using the TEMP.  or  buttons, set the desired temperature. The desired temperature can be changed up to 90°F and down to 64°F.



4. To select the fan speed, press the FAN SPEED button until the desired speed appears in the display (see below).

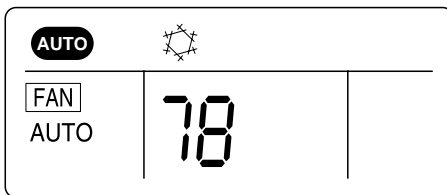

FAN SPEEDS

- "AUTO" The fan will automatically select the fan speed.
- "■" The fan will operate on low speed.
- "▼" The fan will operate on medium speed.
- "▼▼" The fan will operate on high speed.
- "NATURAL" The fan will randomly cycle through the speeds simulating a cool breeze.

TO SET FAN ONLY MODE

To operate only the fan so the unit will circulate the air, proceed as follows:

1. Press the ON/OFF button on the remote control to turn the unit on; the On LED will light on the indoor unit and "ON" will light in the remote display.

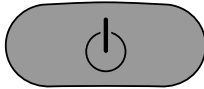

2. Press the MODE button until the Fan indicator  appears in the display.
No allowance setting temperature

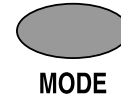

3. To select a fan speed, press the FAN SPEED button until the desired speed appears in the display (see below).

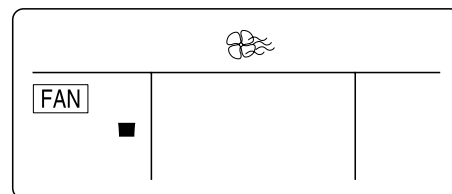

FAN SPEEDS

- "■" The fan will operate on low speed.
- "▼" The fan will operate on medium speed.
- "▼▼" The fan will operate on high speed.
- "NATURAL" The fan will randomly cycle through the speeds simulating a breeze.

NOTE:

- If "NATURAL" is selected, the "NATURAL" indicator on the indoor unit will light.

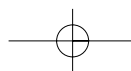

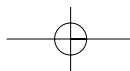



TO SET DEHUMIDIFIER MODE

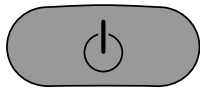

Select this mode when there is high humidity. To select, follow the procedures below.

1. Press the ON/OFF button on the remote control to turn the unit on; the On LED will light on the indoor unit and "ON" will light in the remote display.

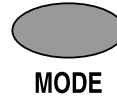

2. Press the MODE button until the Dehumidifier indicator  appears in the display.



3. Using the TEMP.  or  buttons, set the desired temperature. The desired temperature can be changed up to 90°F and down to 64°F.

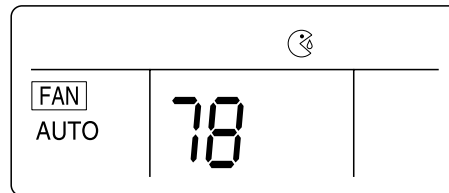

TO SET UNIT TO HEAT MODE (ONLY HEAT PUMP MODEL)

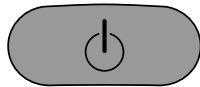

To set the unit to heat the room to a desired temperature, follow the procedures below:

1. Press the ON/OFF button on the remote control to turn the unit on; the On LED will light on the indoor unit and "ON" will light in the remote display.

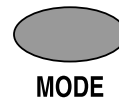

2. Press the MODE button until the Heat indicator appears  in the display. In the heat mode, the fan direction (UP, DOWN) is further downward than that in the cool mode for the good circulation.



3. Using the TEMP.  or  buttons, set the desired temperature. The desired temperature can be changed up to 32°C and down to 18°C.



4. To select the fan speed, press the FAN SPEED button until the desired speed appears in the display (see below).



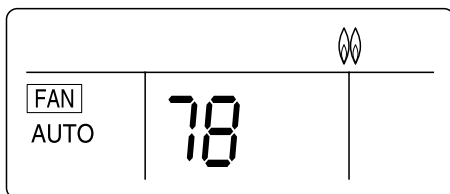

NOTE:

When the heating operation is started, hot air delivery might be delayed due to warm up period.



FAN SPEEDS

- "AUTO" The fan will automatically select the fan speed.
- "" The fan will operate on low speed.
- "" The fan will operate on medium speed.
- "" The fan will operate on high speed.
- "NATURAL" The fan will randomly cycle through the speeds simulating a cool breeze.

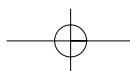

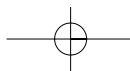

TO SELECT THE FAN DIRECTION

Regardless of the mode the unit is set for, the fan direction can be changed so it moves up and down, left and right or both. Follow procedures below to set fan direction.

1. Press the ON/OFF button on the remote control to turn the unit on; the On LED will light on the indoor unit and "ON" will light in the remote display.

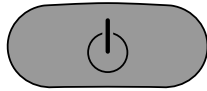

2. Press the MODE button to select the desired mode.

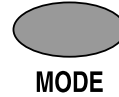

3. Press the FAN DIR. button to select the fan direction. See chart below for detailed information on each of the three settings.

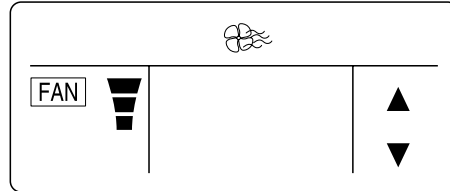

FAN DIR. ▲▼ First Press	▲▼	The air will flow up and down.
Second Press		Normal air direction.

TO SET ON TIMER MODE

This unit can be set to automatically turn on after a predetermined amount of hours (up to 24) in the order of 0.5, 1, 1.5, 2, 2.5, 3, 4, 5, 6, 8, 10, 12, 16, 20, 24.

1. Press the ON/OFF button of timer on the remote control to set the on timer mode, "HOUR" and "ON" on the remote display will be displayed and "TIMER" will be flicked. When you increase to press "ON/OFF" you will get desired time. Then, if pressing "ENTER/CANCEL" button, ON TIMER Mode will be started. If you want to stop ON TIMER Mode, please press "ENTER/CANCEL" again.

2. While the unit is off, press the TIMER ON button; the display will light waiting input for the timer, but the actual unit will not turn on.

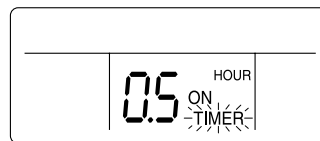
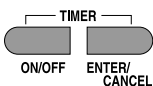

3. Repeatedly press the TIMER ON button until the desired hour that you want the unit to turn on appears on the display. For example, if it is 1:00 P.M. and you want the unit to turn on at 4:00 P.M., select 3 hours.

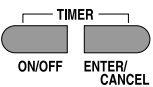

4. Press the ENTER button to input the setting into memory; the unit will beep, the TIMER indicator will light on the unit and the TIMER indicator on the remote will light to indicate the unit is in the timer mode.

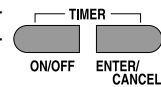

5. Place the remote controller so it is facing the unit. When the desired hour is reached, the unit will turn on to the selected mode.

NOTE : Press the ENTER button within 5 seconds of selecting the desired time. If more than 5 seconds elapse, steps 3 and 4 must be repeated.

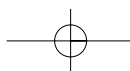
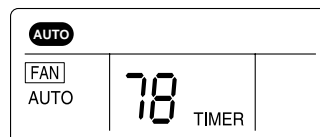

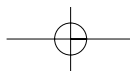

TO SET OFF TIMER MODE

This unit can be set to automatically turn off after a predetermined amount of hours (up to 12) in the order of 0.5, 1, 1.5, 2, 2.5, 3, 4, 5, 6, 8, 10, 12, 16, 20, 24.

1. Press the ON/OFF button of timer on the remote control to set the off timer mode, "HOUR" and "OFF" on the remote display will be displayed and "TIMER" will be flicked. When you increase to press "ON/OFF" you will get desired time. Then, if pressing "ENTER/CANCEL" button, OFF TIMER Mode will be started. If you want to stop OFF TIMER Mode, please press "ENTER/CANCEL" again.

2. Press the TIMER OFF button once to enter the Timer screen.

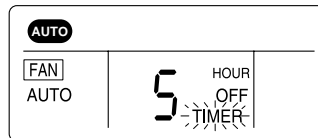
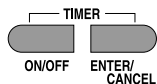

3. Repeatedly press the TIMER OFF button until the desired hour that you want the unit to shut off appears on the display.
For example, if it is 8:00 P.M. and you want the unit to turn off at 10:00 P.M., select 2 hours.

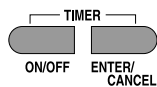

4. Press the ENTER button to input the setting into memory; the unit will beep, the TIMER indicator will light on the unit and the TIMER indicator on the remote will light to indicate the unit is in the timer mode.

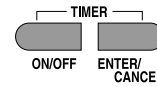

5. When the desired hour is reached, the unit will turn off.

NOTE: Press the ENTER button within 5 seconds of selecting the desired time. If more than 5 seconds elapse, steps 3 and 4 must be repeated.

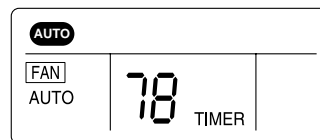

TO SET UNIT TO SLEEP MODE

When you are going to sleep, select this feature and the unit will cool off the room to the desired temperature and then increase that temperature throughout the night.

1. Press the ON/OFF button on the remote control to turn the unit on; the On LED will light on the indoor unit and "ON" will light in the remote display.



2. Press the MODE button to select the desired mode. Then, set the desired temperature using the TEMP. or

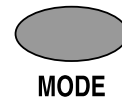

3. Press the SLEEP button on the remote controller. The unit will then be in the sleep mode and will cool the room to the desired temperature. After a while the unit will increase the temperature again. This process will then repeat.



TO CANCEL SLEEP MODE:

To cancel sleep mode, press the SLEEP button again; the SLEEP indicator will disappear in the display.

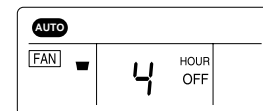

TO SET TURBO/MILD MODE

1. The unit is fixed "MILD" mode on production.
2. Press the "TURBO/MILD" button for powerful operation.
After 30 min, function returns automatically to "MILD" mode.
3. "Turbo" button does not operate in a "Head" mode.
4. When press the "TURBO/MILD" button one more time, it will be back to "MILD" mode.

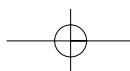
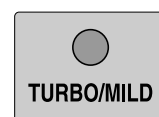

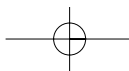

EMERGENCY OPERATION (TAS-12/18/24/12H/18H/24H)

If the remote control is lost, broken or has no batteries, follow the procedures below:

1. Open the indoor unit's cover and press the EMERGENCY/REMOTE button.

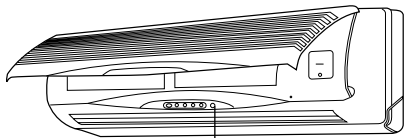

EMERGENCY/REMOTE Switch

2. The unit will then turn on and depending on the room temperature, it will select the cool or dehumidifier, fan speed and fan direction automatically.

3. To turn the unit off, press the EMERGENCY/REMOTE button again.

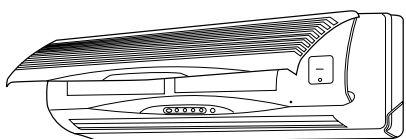

EMERGENCY/REMOTE Switch

EMERGENCY OPERATION (TAS-15/15H)

If the remote control is lost, broken or has no batteries, follow the procedures below:

1. Open the indoor unit's cover and make sure the EMERGENCY/REMOTE switch is set to the EMERGENCY position.

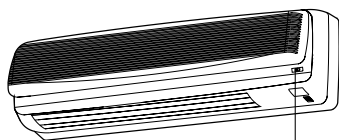

EMERGENCY/REMOTE Switch

2. The unit will then turn on and depending on the room temperature, it will select the cool or dehumidifier mode, fan speed and fan direction automatically.

3. To turn the unit off, slide the EMERGENCY/REMOTE switch to the REMOTE position.

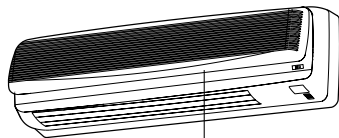

EMERGENCY/REMOTE Switch

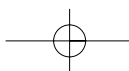

CHANGING/CLEANING THE AIR FILTERS

To change or clean the two black air filters, follow the procedures below:

1. Open the indoor unit's cover and remove both black air filters by bending them slightly backward and the lifting out.

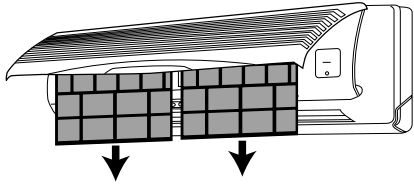

2. Remove the two small filters (Deodorizing and Electrostatic) from the indoor unit.

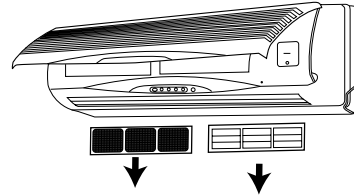

3. Examine the filters and determine if they need to be cleaned or replaced. To clean filters, use a vacuum hose and clean off dust. Use water and mild soap also if necessary.

NOTE: The filters should be changed every 6 months. If in a climate with cold winters, once a year is adequate.

4. Insert cleaned or new small filters (Deodorizing and Electrostatic) back into the unit.

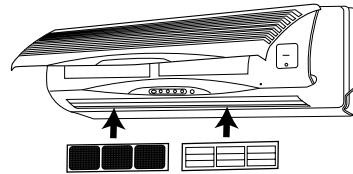

5. Insert cleaned or new black filters back into the unit.

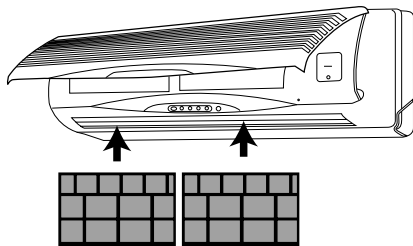

NOTES:

- Wipe the indoor cover with soft sponge or soft cloth.
- When cleaning up it in the state of opening the indoor cover, wipe it with soft cloth.
- After drying it completely in the shade, assemble it.
- If you do not so, it may cause a trouble.
- Reassembly of the indoor cover is reverse process of assembly

CLEANING THE INDOOR COVER

(TAS-12/18/24/12H/18H/24H ONLY)

To clean the indoor cover, follow the procedures below

1. Remove the left and right side to open the indoor cover upward by two hand

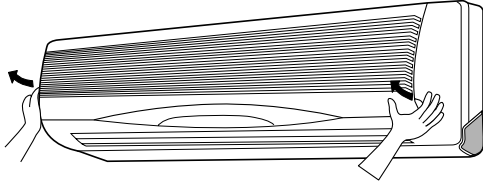

NOTE: Please remove and insert the indoor by two hand

2. Open the door until 80 degree

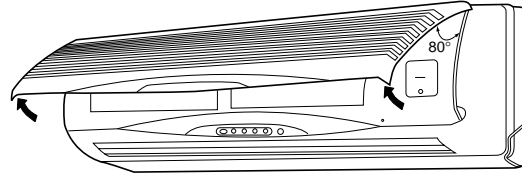

3. Pull right side to remove indoor cover hinge from frame grille hinge hole

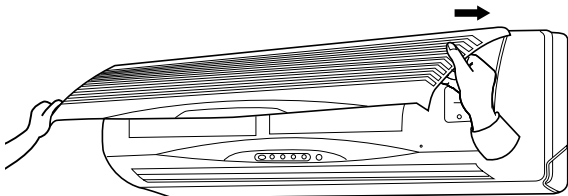

4. Remove the indoor cover

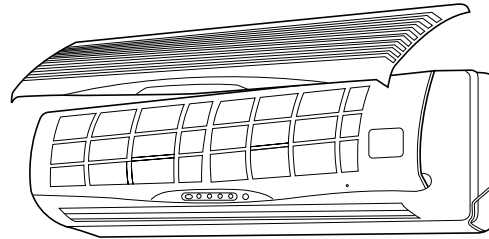

5. Cleaning the indoor

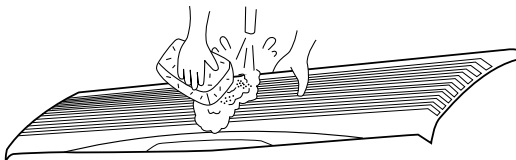

NOTES:

- Wipe the indoor cover with soft sponge or soft cloth.
- When cleaning up it in the state of opening the indoor cover, wipe it with soft cloth
- After drying it completely in the shade, assemble it.
- If you do not so, it may cause a trouble

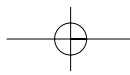

CARE AND MAINTENANCE

warning

- Make sure the AC cord is unplugged and the unit is off before cleaning.
- Do not use water on the unit to clean it. This is a shock hazard and the unit can be damaged.

Clean the casing and front of the indoor unit with a vacuum brush or wipe with a clean damp cloth.

- **NEVER USE** Solvents, harsh chemicals or hot water to clean the unit.
- Some metal edges on the unit are sharp. Be careful when cleaning or handling.
- Internal parts in the outdoor unit may need cleaning or routine maintenance from time to time. Consult your local service center for more details.

AFTER THE SEASON:

- Operate the fan, then dry the indoor unit.
- Shut off the indoor unit and then unplug it from the wall.
- Clean the air filters.
- Cover the outdoor unit with the supplied cover; this is very important to protect this unit.

BEFORE THE SEASON:

- Make sure the air filters are clean.
- Make sure the inlet and outlet on the indoor and outdoor units are not blocked by obstructions.
- Make sure the unit is grounded. Consult a serviceman for help.

PRECAUTIONS:

- Do not use this unit for animal or plant storage.
- In a lightning or thunder storm, immediately unplug it from the wall.

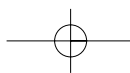

TROUBLESHOOTING GUIDE

Before requesting service, please refer to the chart below for possible solutions:

SYSPOMS	POSSIBLE CAUSE	POSSIBLE SOLUTIONS
No power.	Power failure.	Restore the power
	Line voltage too low.	Contact electrician to install new outlet.
	Unit is unplugged or not completely plugged in.	Insert plug all the way.
	Unit is off.	Turn unit on.
	Batteries in remote are weak or dead.	Replace remote's batteries.
	EMERGENCY/REMOTE switch is not set to REMOTE.	Slide EMERGENCY/REMOTE to REMOTE.
The compressor does not turn on. (no cool air at cooling) (no heat air at heating)	When the unit is first plugged in and turned on, the compressor will delay turn on for 3 minutes.	Wait 3 minutes for the unit to operate.
	If the unit is turned off and then immediately back on, the compressor will delay for 3 minutes.	Wait 3 minutes for the unit to operate.
	The air filter(s) is dirty or clogged.	Clean or replace filter(s).
	A door or window is open.	Shut door or window.
	There is an obstacle in front of intake or indoor unit.	Remove obstacle.
	The temperature has been set improperly.	Check and reset if necessary.
Strange sounds occur.	During operation, especially after turning it on or off, refrigerant flows inside the unit.	This is normal.
Strange smells occur.	The fan is bringing out the smells of the carpet, walls, etc.	The smell should go away shortly.
No remote operation.	Batteries are weak, dead or inserted improperly.	Replace batteries.
	Remote is out of range.	Move closer to unit.
	Remote not aimed at sensor.	Aim remote at sensor.
	There is an obstruction between unit and remote.	Remove obstruction.

INSTRUCTION OF INSTALLATION

Below is an overview for the connection of the Indoor unit to the Outdoor unit.

OVERVIEW

This appliance must be installed according to national power supply requirement.

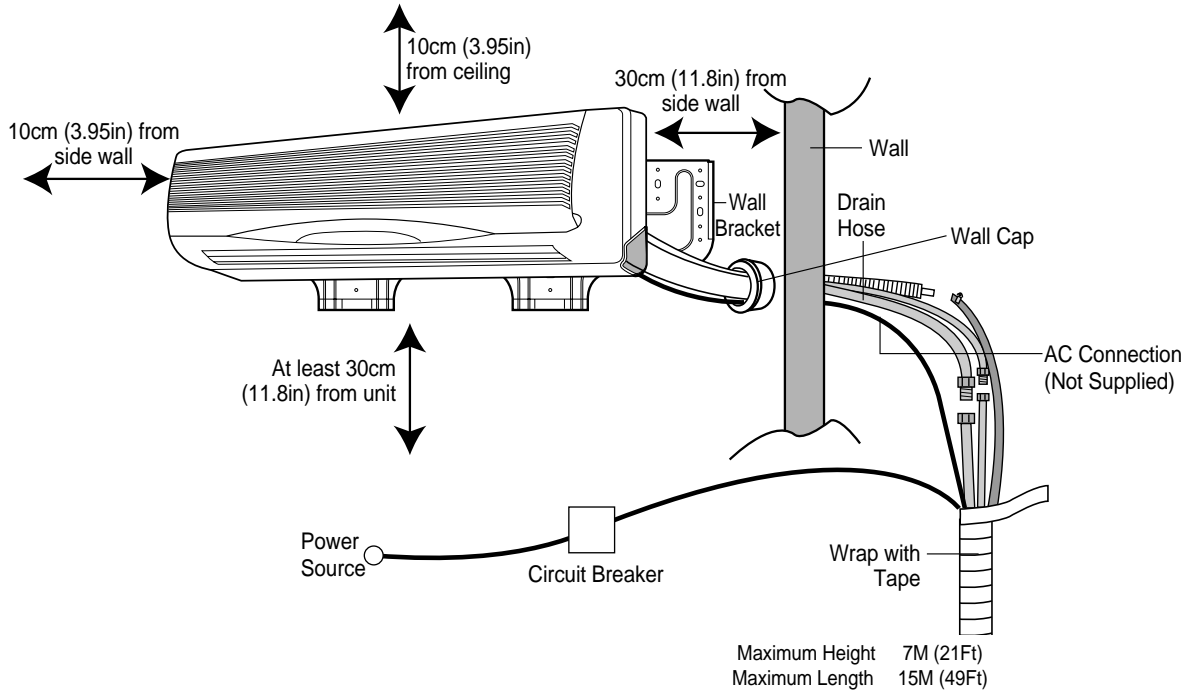

Any tube length between 7.5 and 15 meters must be precharged with freon using the following calculation:
 (Length — 7.5) x 30 grams
 Adding additional tubing will decrease efficiency.

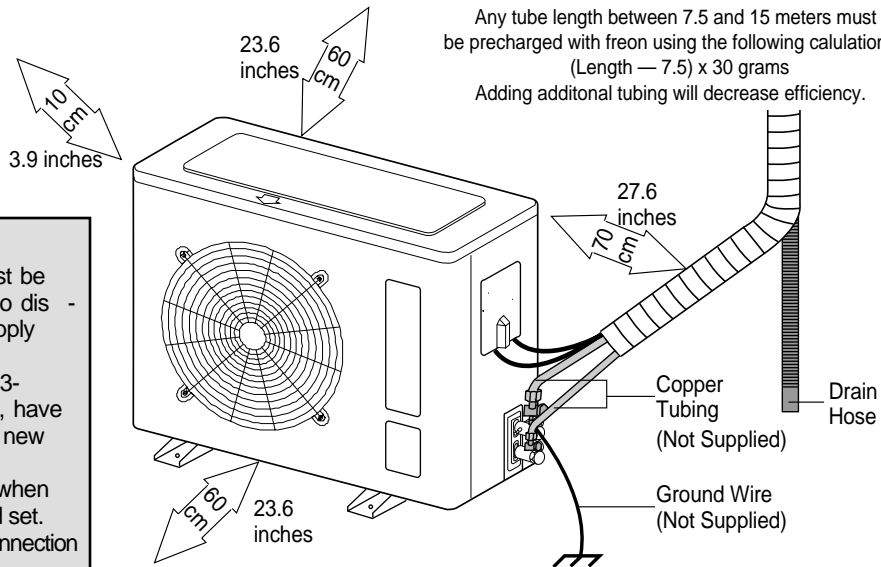

- NOTES:**
- After installation it must be possible for the user to disconnect the power supply plug.
 - If the AC outlet is a 3-pronged type or other, have an electrician install a new outlet.
 - Contact service man when replace the power cord set.
 - The specification of Connection cable is SPT-3 or SJT 16~20AWG.

AIR CONDITIONER MANUFACTURER
Turbo air

**ROOM AIR CONDITIONER
USE & CARE MANUAL
SPLIT TYPE ROOM AIR CONDITIONER**

MODEL #: **TAS-12 / TAS-12H(O)
TAS-15 / TAS-15H(O)
TAS-18 / TAS-18H(O)
TAS-24 / TAS-24H(O)**



Please read this manual carefully and thoroughly before operating the unit.
If you still have any difficulties or problems, consult your dealer for help or Turbo Air Conditioning Corp.
Please keep this manual handy.

W1