

This Owner's Manual is provided and hosted by [Appliance Factory Parts](#).

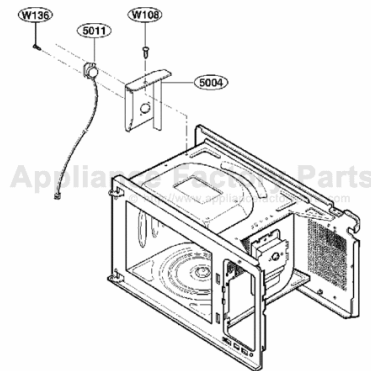

Kenmore 79153 Owner's Manual

[Shop genuine replacement parts for Kenmore 79153](#)



[Find Your Kenmore Microwave Parts - Select From 532 Models](#)

----- Manual continues below -----

Use & Care Guide
Manual de Uso y Cuidado

English / Español

Models/Modelos: 721.7915*

Kenmore®

Microwave Oven

HORNO DE MICROONDAS

* = color number, número de color

P/No.: MFL65001001

Sears Brands Management Corporation
Hoffman Estates, IL 60179 U.S.A.

www.kenmore.com
www.sears.com



Table Of Contents

Warranty	2
Sears Service	3
Microwave Oven Safety	4-6
Getting to Know Your Microwave Oven	7
How Your Microwave Oven Works	7
Radio Interference	7
For the Best Cooking Results	7
Cookware Guide	8
Operating Safety Precautions	8
Electrical Connection	8
Specifications	9
Installation	9
Parts and Accessories.....	9
Control Panel Features	10
Microwave Cooking Tips	11-12
Using Your Microwave Oven	13
Clock	13
Hold 3 Sec	13
Kitchen Timer	13
Control Lock	13
Smart Touch Sensor Operation Instruction	14
Smart Touch Sensor Table	15
Soften/Melt	16
Reheat	17
Timed Cooking	17
Custom Cook	18
Add 1 Minute	18
Control Setup	19
Custom Defrost	20
1 lb Defrost	20
Custom Defrost Table	21-22
Defrosting Tips	23
Two-Stage Cooking	23
Microwave Power Levels	24
UNDERSTANDING TrueCookPlus®	25
USING TrueCookPlus®	26
Questions and Answers	27
Troubleshooting	28
Service	Back Cover

Combination Warranty

One Year Limited Warranty

When installed, operated and maintained according to all instructions supplied with the product, if this appliance fails due to a defect in material or workmanship within one year from the date of purchase, call 1-800-4-MY-HOME® to arrange for free repair.

Five Year Limited Warranty on the Magnetron

For five years from the date of purchase, if the magnetron in this microwave oven fails due to a defect in material or workmanship, Sears will replace the magnetron. Safety regulations require the magnetron to be installed by Sears. After the first year, the customer assumes any labor costs associated with magnetron replacement.

If this appliance is used for other than private family purposes, this warranty applies for only 90 days from the date of purchase.

This warranty covers only defects in material and workmanship. Sears will NOT pay for:

1. Expendable items that can wear out from normal use, including but not limited to filters, belts, light bulbs, and bags.
2. A service technician to instruct the user in correct product installation, operation or maintenance.
3. A service technician to clean or maintain this product.
4. Damage to or failure of this product if it is not installed, operated or maintained according to all instructions supplied with the product.
5. Damage to or failure of this product resulting from accident, abuse, misuse or use for other than its intended purpose.
6. Damage to or failure of this product caused by the use of detergents, cleaners, chemicals or utensils other than those recommended in all instructions supplied with the product.
7. Damage to or failure of parts or systems resulting from unauthorized modifications made to this product.

Disclaimer of implied warranties; limitation of remedies:

Customer's sole and exclusive remedy under this limited warranty shall be product repair as provided herein. Implied warranties, including warranties of merchantability or fitness for a particular purpose, are limited to one year or the shortest period allowed by law. Sears shall not be liable for incidental or consequential damages. Some states and provinces do not allow the exclusion or limitation of incidental or consequential damages, or limitations on the duration of implied warranties of merchantability or fitness, so these exclusions or limitations may not apply to you.

This warranty applies only while this appliance is used in the United States and Canada.

This warranty gives you specific legal rights, and you may also have other rights which vary from state to state.

Sears Brands Management Corporation

Hoffman Estates, IL 60179

Sears Canada Inc., Toronto, Ontario, Canada M5B 2B8

Sears Service

Master Protection Agreement

Congratulations on making a smart purchase.

Your new Kenmore® product is designed and manufactured for years of dependable operation. But like all products, it may require preventive maintenance or repair from time to time.

The Master Protection Agreement also helps extend the life of your new product. Here's what the Agreement* includes:

- ☑ **Parts and labor** needed to help keep products operating properly **under normal use**, not just defects. Our coverage goes **well beyond the product warranty**. No deductibles, no functional failure excluded from coverage - **real protection**.
- ☑ **Expert service** by a force of more than **10,000 authorized Sears service technicians**, which means someone you can trust, will be working on your product.
- ☑ **Unlimited service calls and nationwide service**, as often as you want us, whenever you want us.
- ☑ **"No-lemon" guarantee** - replacement of your covered product if four or more product failures occur within twelve months.
- ☑ **Product replacement** if your covered product can not be fixed.
- ☑ **Annual Preventive Maintenance Check** at your request - no extra charge.
- ☑ **Fast help by phone** - we call it **Rapid Resolution** - phone support from a Sears representative on all products. Think of us as a "talking owner's manual."
- ☑ **Power surge protection** against electrical damage due to power fluctuations.
- ☑ **\$250 Food Loss Protection** annually for any food spoilage that is the result of mechanical failure of any covered refrigerator or freezer.
- ☑ **Rental reimbursement** if repair of your covered product takes longer than promised.
- ☑ **10% discount** off the regular price of any non-covered repair service and related installed parts.

Once you purchase the Agreement, a simple phone call is all that it takes for you to schedule service. You can call anytime, day or night, or schedule a service appointment online.

The Master Protection Agreement is a risk free purchase. If you cancel for any reason during the product warranty period, we will provide a full refund or a prorated refund anytime after the product warranty period expires. Purchase your Master Protection Agreement today!

Some limitations and exclusions apply. For prices and additional information in the U.S.A. call: 1-800-827-6655.

* Coverage in Canada varies on some items.
For full details, call Sears Canada: 1-800-361-6665.

Sears Installation Service

For Sears professional installation of home appliances, garage door openers, water heaters, and other major home items, in the U.S.A. or Canada call:
1-800-4-MY-HOME®

Microwave Oven Safety

IMPORTANT SAFETY INSTRUCTIONS

- The microwave oven should be serviced only by qualified service personnel. Call an authorized service company for examination, repair, or adjustment.
- See door surface cleaning instructions in the “Caring for Your Microwave Oven” section.
- To reduce the risk of fire in the oven cavity:
 - Do not overcook food. Carefully attend to the microwave oven when paper, plastic, or other combustible materials are placed inside the oven to facilitate cooking.
 - Remove wire twist-ties from paper or plastic bags before placing bags in oven.
 - If materials inside the oven ignite, keep oven door closed, turn oven off, and disconnect the power cord, or shut off power at the fuse or circuit breaker panel.
 - Do not use the cavity for storage purposes. Do not leave paper products, cooking utensils, or food in the cavity when not in use.
- This Microwave Oven is suitable for use above both gas and electric cooking and equipment.
- This Microwave Oven is intended to be used above ranges with a maximum width of 36 inches (91 cm).
- Clean Ventilating Hoods frequently - grease should not accumulate on hood or filter.
- When flaming foods under the hood, turn the fan on.
- Use care when cleaning the vent-hood filter. Corrosive cleaning agents, such as lye-based oven cleaners, may damage the filter.
- Oversized foods or oversized metal utensils should not be inserted in the microwave oven, as they may create a fire or risk of electric shock.
- Do not clean with metal scouring pads. Pieces can break off the pad and touch electrical parts, causing a risk of electric shock.
- Do not store anything directly on top of the microwave oven when the microwave oven is in operation.
- Do not cover or block any openings on the microwave oven.
- Do not store this microwave oven outdoors.
- Do not use the microwave oven near water - for example, near a kitchen sink, in a wet basement, near a swimming pool, or similar location.
- Do not immerse cord or plug in water.
- Keep cord away from heated surfaces.
- Do not let cord hang over edge of table or counter.
- Do not mount over a sink.
- Do not cover any part of the oven with metal foil. Doing so will cause overheating of the oven.
- Liquids such as water, coffee, or tea are able to overheat beyond the boiling point without appearing to be boiling due to surface tension of the liquid. Visible bubbling or boiling when the container is removed from the microwave oven is not always present. This could result in very hot liquids suddenly boiling over when a spoon or other utensil is inserted into the liquid. To reduce the risk of injury to persons:
 - 1) Do not overheat the liquid.
 - 2) Stir the liquid before and halfway through heating it.
 - 3) Do not use straight-sided containers with narrow necks.
 - 4) After heating, allow the container to stand in the microwave oven for a short time before removing the container.
 - 5) Use extreme caution when inserting a spoon or other utensil into the container.

SAVE THESE INSTRUCTIONS

Your safety and the safety of others is very important.

We have provided many important safety messages in this manual and on your microwave oven. Always read and obey all safety messages.



This is the safety alert symbol.

This symbol alerts you to hazards that can kill or hurt you and others. All safety messages will be preceded by the safety alert symbol and the word "DANGER" or "WARNING." These words mean:

DANGER

You will be killed or seriously injured if you do not follow instructions immediately.

WARNING

You can be killed or seriously injured if you do not follow instructions.

All safety messages will identify the hazard, tell you how to reduce the chance of injury, and tell you what can happen if the instructions are not followed.

IMPORTANT SAFETY INSTRUCTIONS

When using electrical appliances, basic safety precautions should be followed, including the following:

- ⚠️ WARNING:** To reduce the risk of burns, electric shock, fire, injury to persons, or exposure to excessive microwave energy:
- Read all instructions before using the microwave oven.
 - Read and follow the specific "PRECAUTIONS TO AVOID POSSIBLE EXPOSURE TO EXCESSIVE MICROWAVE ENERGY" found on page 5.
 - The microwave oven must be grounded. Connect only to properly grounded outlet. See "GROUNDING INSTRUCTIONS" found on page 5.
 - Install or locate the microwave oven only in accordance with the provided installation instructions.
 - Some products such as whole eggs in the shell and sealed containers, such as closed jars, can explode and should not be heated in the microwave oven.
 - Use the microwave oven only for its intended use as described in this manual.
 - Do not use corrosive chemicals or vapors in the microwave oven. This type of oven is specifically designed to heat, cook, or dry food. It is not designed for industrial or laboratory use.
 - As with any appliance, close supervision is necessary when used by children.
 - Do not operate the microwave oven if it has a damaged cord or plug, if it is not working properly, or if it has been damaged or dropped.

SAVE THESE INSTRUCTIONS

PRECAUTIONS TO AVOID POSSIBLE EXPOSURE TO EXCESSIVE MICROWAVE ENERGY

- (a) Do not attempt to operate this oven with the door open. Doing so can result in harmful exposure to microwave energy. It is important not to defeat or tamper with the safety interlocks.
- (b) Do not place any object between the oven front face and the door, or allow soil or cleaner residue to accumulate on sealing surfaces.
- (c) Do not operate the oven if it is damaged. It is particularly important that the oven door closes properly and that there is no damage to the:
 - (1) Door (bent)
 - (2) Hinges and latches (broken or loosened)
 - (3) Door seals and sealing surfaces
- (d) The oven should not be adjusted or repaired by anyone except for a properly qualified service technician.

ELECTRICAL REQUIREMENTS

Observe all governing codes and ordinances. A 120-Volt, 60-Hz, AC-only, 15 or 20-amp fused electrical supply is required. A time delay fuse is recommended. It is recommended that a separate circuit, serving only this appliance, is provided.

⚠ DANGER



Electrical Shock Hazard
Plug into a grounded 3 prong outlet. Do not remove ground prong. Do not use an adapter. Do not use an extension cord. Failure to follow these instructions can result in death, fire, or electrical shock.

GROUNDING INSTRUCTIONS

•**For all cord connected appliances:**
The microwave oven must be grounded. In the event of an electrical short circuit, grounding reduces the risk of electric shock by providing an escape wire for the electric current. The microwave oven is equipped with a cord having a grounding wire with a grounding plug. The plug must be plugged into an outlet that is properly installed and grounded.

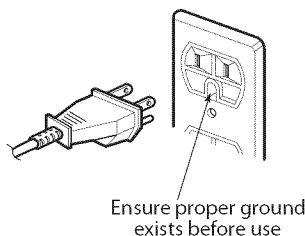

Ensure proper ground exists before use

⚠ **WARNING:** Improper grounding can result in a risk of electric shock. Consult a qualified electrician or service technician if you do not understand the grounding instructions, or if you wonder whether the appliance is properly grounded. Do not use an extension cord. If the power supply cord is too short, have a qualified electrician or service technician install an outlet near the microwave oven.

•**For a permanently connected appliance:**
This appliance has a short power supply cord to reduce the risk of anyone tripping over or becoming entangled in the cord. The microwave oven must be connected to a grounded, metallic, permanent wiring system, or an equipment grounding conductor should be run with the circuit conductors and connected to the equipment grounding terminal or lead on the microwave oven.

SAVE THESE INSTRUCTIONS

Getting to Know Your Microwave Oven

This section discusses the concepts behind microwave cooking. It also shows the basics that you need to know in order to operate your microwave oven. Please read this information before using your oven.

HOW YOUR MICROWAVE OVEN WORKS

Microwave ovens are safe. Microwave energy is not hot. It causes food to make its own heat, and it is this heat that cooks the food.

Microwaves are like TV waves, radio waves, or light waves. You cannot see them, but you can see the results of what they do.

A magnetron in the microwave oven produces microwaves. The microwaves move into the oven where they contact food as it turns on the turntable.

The glass turntable of your microwave oven lets microwaves pass through. The microwaves then bounce off a metal floor, back through the glass turntable, and are absorbed by the food.

Microwaves pass through most glass, paper, and plastics without heating them, so food absorbs the energy. Microwaves bounce off metal containers so food does not absorb the energy.

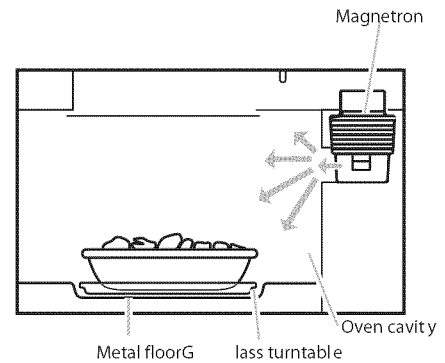

RADIO INTERFERENCE

Using your microwave oven may cause interference to your radio, TV, or similar equipment. When there is interference, you can reduce it or remove it by:

- **Cleaning** the door and sealing surfaces of the oven.
- **Adjusting** the receiving antenna of the radio or television.
- **Moving** the receiver away from the microwave oven.
- **Plug** the microwave oven into a different outlet so that the microwave oven and receiver are on different branch circuits.

FOR THE BEST COOKING RESULTS

- **Always cook food** for the shortest cooking time recommended. Check to see how the food is cooking. If needed, touch Add 30 Sec while the oven is operating, or after the cooking cycle is over (see the "Add 30 Sec" section).
- **Stir, turn over, or rearrange** the food being cooked about halfway through the cooking time for all recipes. This will help ensure that the food is evenly cooked.
- **If you do not have a cover for a dish**, use wax paper, or microwave-approved paper towels or plastic wrap. Remember to turn back a corner of the plastic wrap to vent steam during cooking.

COOKWARE GUIDE

Most heat resistant, nonmetallic cookware is safe for use in your microwave oven. However, to test cookware before using, follow these steps:

1. Place empty cookware in the microwave oven.
2. Measure 1 cup (250ml) of water in a glass measuring cup and place it in the oven beside the cookware.
3. Microwave on 100% power for 1 minute. If the dish is warm, it should not be used for microwave cooking.

NOTE:

Some dishes (melamine, some ceramic dinnerware, etc.) absorb microwave energy, becoming too hot to handle and slowing cooking time. Cooking in metal containers, not designed for microwave use, could damage the oven, as could containers with hidden metal (twist-ties, foil lining, staples, metallic glaze or trim).

OPERATING SAFETY PRECAUTIONS

- **Never** lean or allow a child to swing on the door when it is open.
- **Use hot pads.** Microwave energy does not heat containers, but the heat from the food can make the container hot.
- **Do not** use newspaper or other printed paper in the oven.
- **Do not** dry flowers, fruit, herbs, wood, paper, gourds, or clothes in the oven.
- **Do not** start a microwave oven when it is empty. This may shorten the life-span of the oven. To practice programming, put a container of water in the oven before starting. It is normal for the oven door to look wavy after the oven has been running for a while.
- **Do not** try to melt paraffin wax in the oven. Paraffin wax will not melt in a microwave oven because it allows microwaves to pass through it.
- **Do not** operate the microwave oven unless the glass turntable is securely in place and can rotate freely. The turntable can rotate in either direction. **Make sure** the turntable is correct-side up in the oven. **Handle your turntable with care** when removing from the oven to avoid breaking it.
- **When using a browning dish,** the browning dish bottom must be at least 3/16 inch above the turntable. Follow the directions supplied with the browning dish.
- **Never cook or reheat a whole egg inside the shell.** Steam buildup in whole eggs may cause them to burst, and possibly damage the oven. **Slice** hard-boiled eggs before heating. In rare cases, poached eggs have been known to explode. **Cover** poached eggs and **allow** a standing time of one minute before cutting into them.
- **For best results, stir any liquid several times during heating or reheating.** Liquids heated in certain containers (especially containers shaped like cylinders) may overheat. The liquid may splash during or after heating or when adding ingredients (coffee granules, tea bags, etc.). This can harm you or damage the microwave oven.
- **Microwaves** may not reach the center of a roast. The heat spreads from the outer to the center cooked areas, just as in regular oven cooking. This is one of the reasons for letting some foods (for example, roasts or baked potatoes) stand for a while after cooking, or for stirring some foods during the cooking time.
- **Do not deep fry in the oven.** Microwavable utensils are not suitable and it is difficult to maintain appropriate deep-frying temperatures.
- **Do not overcook potatoes.** At the end of the recommended cooking time, potatoes should be slightly firm because they will continue cooking during standing time. **After microwaving,** let potatoes stand for 5 minutes. They will finish cooking while standing.

ELECTRICAL CONNECTION

If your electric power line or outlet voltage is less than 110 volts, cooking times may be longer. Have a qualified electrician check your electrical system.

SPECIFICATIONS

Power Supply	120V AC, 60 Hz
Rated Power Consumption	1,750W
Microwave Output	*1,200W
Rated Current	14.5A
Overall Dimensions(WxHxD)	21 ^{7/8"} x 12 ^{1/2"} x 17 ^{7/32"}
Oven Cavity Dimensions(WxHxD)	15 ^{21/32"} x 10 ^{7/16"} x 15 ^{27/32"}
Capacity of Oven Cavity	1.5 cu.ft

*IEC 60705 RATING STANDARD

Specifications subject to change without prior notice.

INSTALLATION

1. Remove your Kenmore microwave oven and all packing materials from the shipping carton.
2. Place the oven on a level surface that provides at least four inches of space at the left, right, top, and rear sides for proper ventilation.
3. Place the turntable on the support. Fit the raised, curved lines in the center of the turntable bottom between the three spokes of the hub. The rollers on the support should fit inside the turntable bottom ridge. Place the glass turntable in the oven upside down. Blocking the inlet and/or outlet openings can damage the oven.

NOTE: Never place the glass turntable in the oven upside down. Blocking the inlet and/or outlet openings can damage the oven.

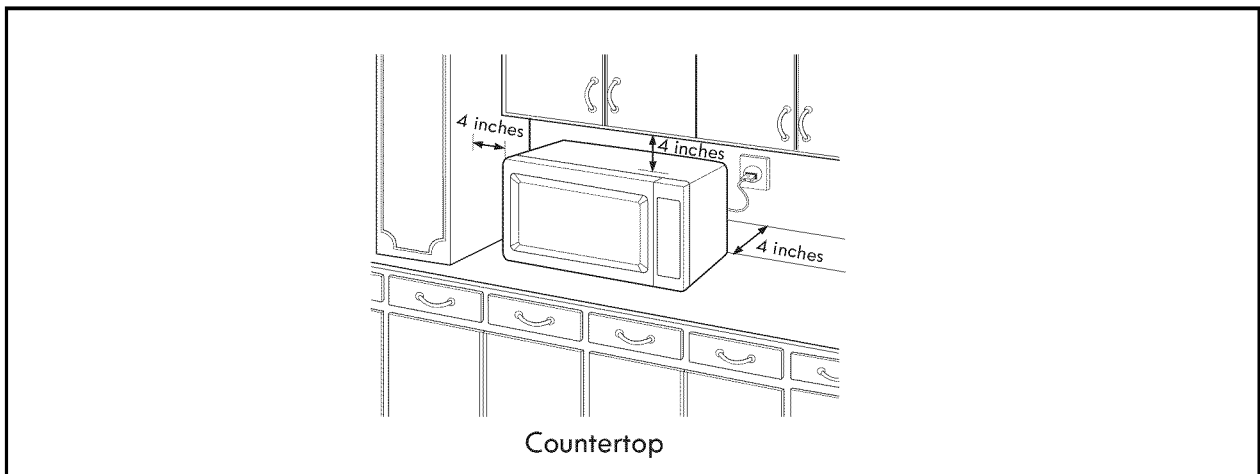

⚠️ WARNING:

To reduce the risk of fire or electric shock, do not install closer than four inches from side and back wall.

PARTS AND ACCESSORIES

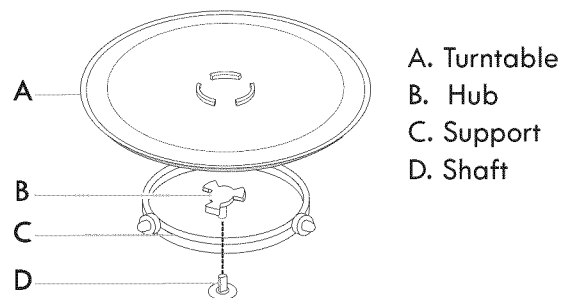
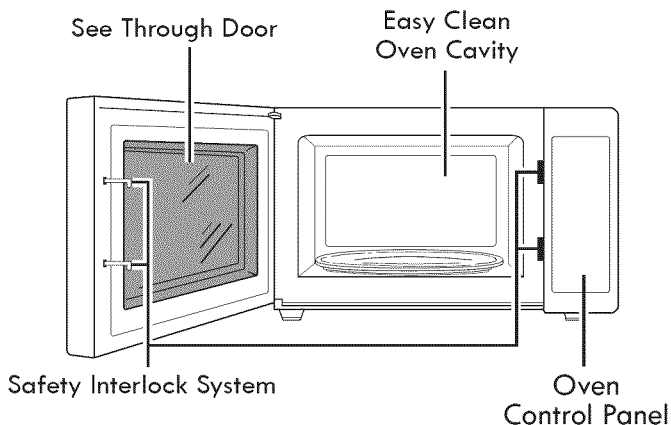

CONTROL PANEL FEATURES

Your microwave oven control panel lets you select the desired cooking function quickly and easily. All you have to do is touch the necessary Command Pad. The following is a list of all the Command and Number Pads located on the control panel. **For more information on these features, see the “Using your microwave oven” section.**

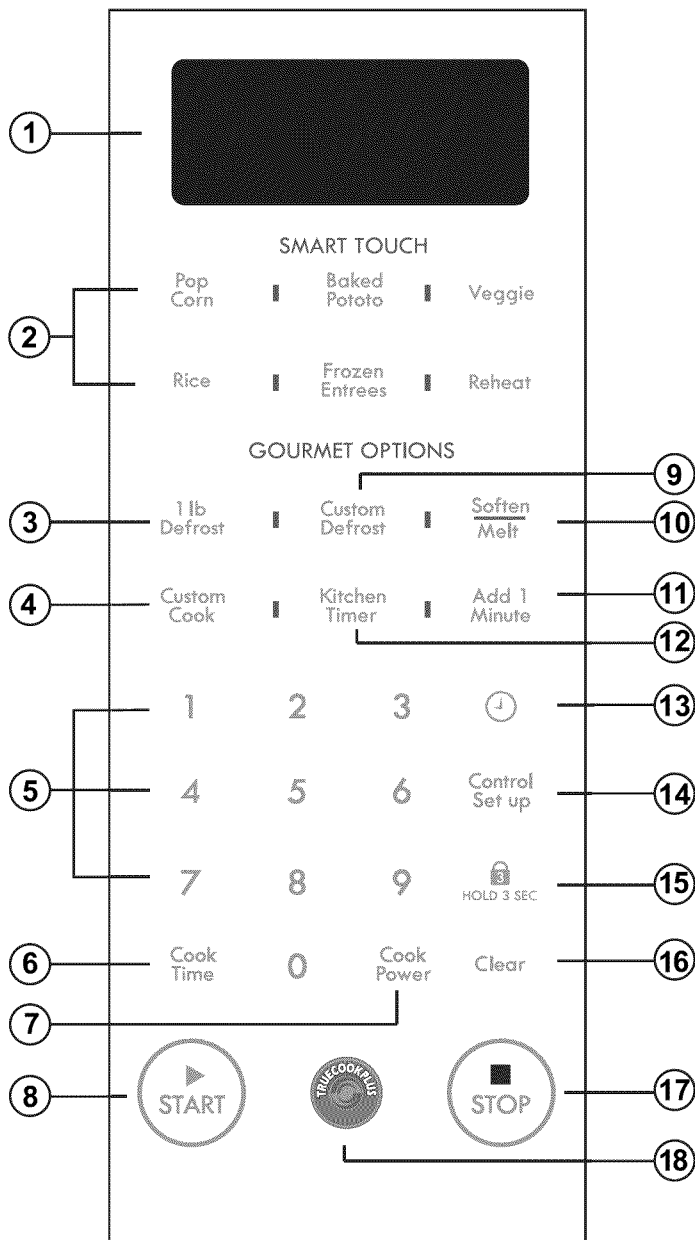

- 1. Display:** The display includes a clock and indicators that show the time of day, cooking time settings, and cooking functions selected.
- 2. Smart Touch:** This pad allows you to cook most of your favorite foods without having to select cooking times and power levels.
- 3. 1 lb Defrost:** This pad contains Exact and Auto defrosting methods. The Exact Defrost is an accurate defrosting method for frozen meat, poultry, and fish up to 6.0 lbs or 4.0 kgs.
- 4. Custom Cook:** Touch this pad to select programming food items.
- 5. Number Pads:** Touch number pads to enter cooking time, power level, quantity or weight.
- 6. Cook Time:** Touch this pad to set a cooking time.
- 7. Cook Power:** Touch this pad to set a cooking power.
- 8. START:** Touch this pad to start all entries (except for the Smart Touch Sensor, Custom Defrost and Add 1 Minute functions which start automatically).
- 9. Custom Defrost:** This pad is an accurate defrosting method for frozen meat, poultry and fish up to 6.0 lbs or 4.0 kgs.
- 10. Soften/Melt:** Touch this pad to soften ice cream, cream cheese, butter or frozen juice and melt chocolate, cheese, butter or marshmallows.
- 11. Add 1 Minute:** Touch this pad to cook for one minute, up to 99 minutes and 59 seconds, at 100% cook power.
- 12. Kitchen Timer:** Touch this pad to use your microwave oven as a kitchen timer.
- 13. Clock:** Touch this pad to enter the correct time of day.
- 14. Control Setup:** Touch this pad to change the oven default settings for sound, clock, scroll speed and lbs/kg.
- 15. Hold 3 Sec.:** Touch and hold this pad for three seconds to lock the control panel.
- 16. Clear:** Touch this pad to clear the oven entries.
- 17. STOP:** Touch this pad to stop cooking.
- 18. TrueCookPlus®:** Touch this pad to cook food according to a TrueCookPlus® code.

Microwave Cooking Tips

Amount of Food

- **If you increase or decrease** the amount of food you prepare, the time it takes to cook that food will also change. For example, if you double a recipe, add a little more than half the original cooking time. Check for readiness and, if necessary, add more time in small increments.

Starting Temperature of Food

- **The lower the temperature** of the food being put into the microwave oven, the longer it takes to cook. Food at room temperature will reheat quicker than food at refrigerator temperature.

Composition of Food

- **Food with a lot of fat and sugar** will heat faster than food containing a lot of water. Fat and sugar will also reach a higher temperature than water in the cooking process.
- **The more dense the food**, the longer it takes to heat. "Very dense" food, like meat, takes longer to heat than lighter, more porous food, like sponge cakes.

Size and Shape

- **Smaller pieces of food** will cook faster than larger pieces. Also, same shaped pieces cook more evenly than differently shaped pieces.
- **With foods that have different thicknesses**, the thinner parts will cook faster than the thicker parts. Place the thinner parts of chicken wings and legs in the center of the dish.

Stirring and Turning Foods

- **Stirring and turning foods** spreads heat quickly to the center of the dish and avoids overcooking at the outer edges of the food.

Covering Food

Cover food to reduce splattering, shorten cooking times, and keep food moist.

You can use any covering that lets microwaves pass through. See "Getting to Know Your Microwave Oven" for materials that microwaves will pass through.

Releasing Pressure in Foods

- **Several foods** (for example: baked potatoes, sausages, egg yolks, and some fruits) are tightly covered by a skin or membrane. Steam can build up under the membrane during cooking, causing the food to burst. To relieve the pressure and to prevent bursting, pierce these foods before cooking with a fork, cocktail pick, or toothpick.

Using Standing Time

- **Always allow food to stand**, either in or out of the oven, after cooking power stops. Standing time after defrosting and cooking allows the temperature to evenly spread throughout the food, improving the cooking results. For inside oven standing time, you can program "0" power second stage of the cooking cycle. See Two-Stage Cooking.
- **The length of the standing time** depends on how much food you are cooking and how dense it is. Sometimes it can be as short as the time it takes to remove the food from the oven and take it to the serving table. However, with a larger, denser food item, the standing time may be as long as 10 minutes.

Arranging Food

For best results, place food evenly on the plate. You can do this in several ways:

- **If you are cooking several items of the same food**, such as baked potatoes, place them in a ring pattern for uniform cooking.
- **When cooking foods of uneven shapes or thickness**, such as chicken breasts, place the smaller or thinner area of the food towards the center of the dish where it will be heated last.
- **Layer thin slices of meat** on top of each other.
- **When you cook or reheat whole fish**, score the skin – this prevents cracking.
- **Do not** let food or a container touch the top or sides of the oven. This will prevent possible arcing. Arcing is a spark that can cause damage to the oven interior.

Using Aluminum Foil

NOTE: Metal containers should not be used in a microwave oven. There are, however, some exceptions. If you have purchased food prepackaged in an aluminum foil container, refer to the instructions on the package. When using aluminum foil containers, cooking times may be longer because microwaves will only penetrate the top of the food. When using aluminum containers without package instructions, follow these guidelines:

- Place the container in a glass bowl and add some water so that it covers the bottom of the container; no more than 1/4 in. (.64 cm) high. This ensures even heating of the container bottom.
- Always remove the lid to avoid damage to the oven.
- Use only undamaged containers.
- Do not use containers taller than 3/4 in. (1.9 cm).
- Container must be at least half filled.
- To avoid arcing, there must be a minimum 1/4 in. (.64 cm) between the aluminum container and the walls of the oven and also between two aluminum containers.
- Always place the container on the turntable.
- Shield, with small pieces of aluminum foil, parts of food that may cook quickly; such as wing tips and leg ends of poultry.
- Heating food in aluminum foil containers usually takes up to double the time compared to reheating in plastic, glass, china, or paper containers. The time when food is ready will vary depending upon the type of container used.
- Let food stand for 2 to 3 minutes after heating so that heat is spread evenly throughout container.

Cooking you should not do in your microwave oven

- Do not put canned foods in the oven. Closed glass jars may explode, resulting in damage to the oven.
- Do not use the microwave oven to sterilize objects (baby bottles, etc.). It is difficult to keep the oven at the high temperature needed for sterilization.

Using Your Microwave Oven

This section gives instructions for operating each function. Please read this section carefully.

CLOCK

Example: To set the clock for 10:30 A.M.

Touch: **Display Shows:**

- | | |
|--|--------------------------------|
| 1. Clear | : |
| 2.  | : ENTER TIME OF DAY |
| 3.     | 10:30
TOUCH START |
| 4.  | 10:30
AM TOUCH 1 PM TOUCH 2 |
| 5.  | AM 10:30
TOUCH START |
| 6.  | AM 10:30 |

NOTE: This is a 12 hour clock. You can switch between AM and PM by touching 1 or 2 as shown in step 5.

HOLD 3 SEC

Use this safety feature to lock the control panel when you are cleaning the oven, or so that children cannot use the oven unsupervised.

To set HOLD 3 SEC lock:

Touch: **Display Shows:**

- | | |
|---|--|
| 1. Clear | Time of day. |
| 2.  | Touch and hold until
LOCKED
appears in the display
(approximately 3 seconds). |

To cancel HOLD 3 SEC lock:

Touch: **Display Shows:**





- | | |
|---|---|
| 1.  | Touch and hold until
LOCKED
disappears in the display
(approximately 3 seconds). |
|---|---|

KITCHEN TIMER

Your microwave oven can be used as a kitchen timer. You can set up to 99 minutes and 99 seconds.

Example: To set three minutes.

Touch: **Display Shows:**

- | | |
|---|----------------------------------|
| 1. Kitchen
Timer | : ENTER TIME IN MIN AND SEC |
| 2.    | 3:00
TOUCH START |
| 3.  | 3:00 TIMER
Time counting down |

SMART TOUCH SENSOR OPERATION INSTRUCTION

SENSOR OPERATING INSTRUCTIONS

Sensor cook cooking allows you to cook most of your favorite foods without selecting cooking times and power levels. The oven automatically determines required cooking time for each food item. When the internal sensor detects a certain amount of humidity coming from the food, it will tell the oven how much longer to heat. The display will show the remaining heating time. For best results by Sensor, following these recommendations:

- Food cooked with the sensor system should be at normal storage temperature.
- The glass tray and outside of the container should be dry to assure best cooking results.
- Foods should always be covered loosely with microwavable plastic wrap, waxed paper or a lid.
- Do not open the door or touch the STOP key during the sensing time. When sensing time is over, the oven beeps twice and the remaining cooking time will appear in the display window. At this time you can open the door to stir, turn or rearrange the food.

SENSOR COOKING GUIDE

Appropriate containers and coverings help assure good Sensor Cooking results.

- Always use microwavable containers and cover them with lids or vented plastic wrap.
- Never use tight-sealing plastic covers. They can prevent steam from escaping and cause food to overcook.
- Match the amount to the size of the container. Fill containers at least half way for best results.
- Be sure that the outside of the cooking container and the inside of the microwave oven are dry before placing food in the oven. Beads of moisture turning into steam can mislead the sensor.

BAKED POTATO (EXAMPLE)

Sensor Cook allows you to cook most of your favorite foods without selecting cooking times and power levels. This oven automatically determines required cooking times for each food item.

Example: To cook a potato.

Touch:

1. Clear

2. Baked
Potato

Display Shows:

Time of day.

POTATO

The oven will start automatically.

SMART TOUCH SENSOR TABLE

CATEGORY	DIRECTION		AMOUNT
Veggies	Fresh	Prepare as desired, wash, and leave residual water on the vegetables. Place in an appropriately-sized microwave container, cover with plastic wrap and vent.	1-4 cups
	Frozen	Remove from package, rinse off frost under running water. Place in an appropriately sized microwave container. Add amount of water according to the quantity. (1-2 cups: 2 tablespoons, 3-4 cups: 4 tablespoons). Cover with plastic wrap and vent. After cooking, stir and allow to stand for 3 minutes.	1-4 cups
Popcorn	Popcorn lets you pop commercially packaged microwave popcorn. Pop only one package at a time. For best results, use a fresh bag of popcorn. Place bag of prepackaged microwave popcorn on the center of turntable.		3.0-3.5 oz. package (regular size)
Baked Potato	Pierce each potato with a fork and place on the oven tray around the edge, at least one inch apart. After cooking, let stand for five minutes.		1-4 medium approximately (9 oz. each)
Frozen Entree	Remove entree from the outer display package and slit cover. If not in microwave safe container, place on a plate. Cover with plastic wrap and vent. After cooking, let stand for 3 minutes.		10 to 21 oz
Rice	Place rice and twice as much liquid (water, chicken or vegetable stock) in a 2 quart microwavable dish. Cover with plastic wrap and vent. When cooking is complete, let stand for 10 minutes. Stir for fluffier rice.		1-2 cups Use medium or long grain rice. Cook instant rice according to directions on the package.

SOFTEN/MELT

The oven uses low power to melt foods (butter, chocolate, marshmallows and cheese). See the following table.

Example: To Melt 8 oz. Chocolate.

- | | |
|--|--|
| Touch: | Display Shows: |
| 1. Clear | Time of day. |
| 2. <u>Soften</u>
Melt | SOFTEN TOUCH 1
MELT TOUCH 2 |
| 3. 2 | SELECT MENU
1 TO 4 |
| 4. 2 | CHOCOLATE TOUCH
1 TO 2 |
| 5. 2 | 8 OZ
TOUCH START |
| 6.  | Time counting down and
CHOCOLATE
will appear in display. |

MELT TABLE

Code	Category	Direction	Amount
1	Butter/ Margarine	Unwrap and place in microwavable container. No need to cover butter. Stir at the end of cooking to complete melting.	1, 2 or 3 sticks
2	Chocolate	Choose the 4 or 8 oz. (actual weight) selection to melt squares of baking chocolate. Unwrap squares and place them in a microwavable container. Stir at the end of cycle to complete melting. If using chocolate morsels, always use the 4 oz. setting. Stir at the end of the cycle to complete melting. Add time as necessary if more than 4 oz. dry measure is being melted.	4 or 8 oz.
3	Cheese	Use processed cheese only. Cut into cubes. Place in a single layer in microwavable container. Stir at the end of cooking to complete melting.	8 or 16 oz.
4	Marsh- mallows	Large or miniature marshmallows may be used. Place in microwavable container. Stir at the end of the cycle to complete melting.	5 or 10 oz.

SOFTEN TABLE

Code	Category	Direction	Amount
1	Butter	Unwrap and place in microwavable container. No need to cover butter. Butter will be at room temperature and ready for use in recipe.	1, 2 or 3 sticks
2	Ice Cream	Place container in oven. Ice cream will be soft enough to make scooping easier.	Pint, Quart, Half gallon
3	Cream Cheese	Unwrap and place in microwavable container. Cream cheese will be at room temperature and ready for use in recipe.	3 or 8 oz.
4	Frozen Juice	Remove top. Place in oven. Frozen juice will be soft enough to easily mix with water.	6, 12 or 16 oz.

REHEAT

This feature allows you to reheat precooked, room temperature or refrigerated food without selecting cooking times and power levels. This feature has four categories: Dinner Plate, Soup/Sauce, Casserole, and Pizza.

Example: To reheat Casserole.

Touch:	Display Shows:
1. Clear	Time of day
2. Reheat	SELECT MENU 1 TO 3
3. 3	CASSEROLE

The oven will reheat food automatically by sensor system.

REHEAT TABLE

Code	Category	Direction	Amount
1	Dinner Plate	Place foods to be heated on dinner plate or similar dish. Cover with plastic wrap.	Approx. 10.3-15.5 oz.
2	Soup/Sauce	Place foods to be heated in an appropriately sized microwave container. Cover with plastic wrap.	1-4 cups
3	Casserole	Cover dish containing the casserole with plastic wrap.	1-4 cups

TIMED COOKING

This feature lets you program a specific cook time and power. For best results, there are 10 power level settings in addition to HIGH (100%) power. Refer to the "Microwave Power Levels Table" for more information.

NOTE: If you do not select a power level, the oven will automatically cook at HIGH (100%) power.

Example: To cook for 5 minutes, 30 seconds at 80% power.

Touch:	Display Shows:
1. Cook Time	: ENTER COOKING TIME
2. 5 3 0	5:30 TOUCH START OR POWER LEVEL
3. Cook Power	5:30 POWER 100 ENTER POWER LEVEL 0 TO 10
4. 8	5:30 POWER 80 TOUCH START
5. START	Time counting down and POWER 80 will appear in display.

USING YOUR MICROWAVE OVEN

CUSTOM COOK

Use this function to cook food without entering a cook time or power. Refer to the Custom Cook Table below for more information.

Example: To cook 4 slices of bacon.

Touch:	Display Shows:
1. Custom Cook	SELECTION MENU 1 TO 6
2. 1	BACON TOUCH 1 - 5
3. 3	4 SLICES TOUCH START
4. 	Time counting down and BACON will appear in display.

ADD 1 MINUTE

This is a time-saving pad. It is a simplified control that lets you quickly set and start microwave cooking at 100% power without the need to touch START.

Example: To cook for 2 minutes.

Touch:	Display Shows:
1. Clear	Time of day.
2. Add 1 Minute	Time counting down and POWER 100 will appear in the display.

NOTE: Each time you touch ADD 1 MINUTE, it will add one minute up to 99 min 59 seconds.

CUSTOM COOK TABLE

CODE	CATEGORY	DIRECTION	AMOUNT
1	Bacon	Place bacon strips on microwave bacon rack for best results. (Use dinner plate lined with paper towels if rack is not available.)	2 to 6 slices
2	Frozen Roll/Muffin	Remove from display package and place on plate. (If muffins are over 3 oz. each, count as two when entering quantity.)	1 to 6 pieces (2-3 oz. each)
3	Fresh Roll/Muffin	Remove from display package and place on plate. (If muffins are over 3 oz. each, count as two when entering quantity.)	1 to 6 pieces (2-3 oz. each)
4	Beverage	Remove from display package and place on plate. (Be careful! The beverage will be very hot. Sometimes liquids heated in cylindrical containers will splash out when the cup is moved.)	1 to 2 cups
5	Chicken Pieces	Place the chicken pieces in an appropriately sized microwaveable container, cover with plastic wrap, and vent.	0.5 to 2 lbs.
6	Hot Cereal	Prepare as directed on package and cook. Stir and allow standing time before eating. Use only instant hot cereal.	1 to 6 servings

Category	Touch	Amount
Bacon	1	2 slices
	2	3 slices
	3	4 slices
	4	5 slices
	5	6 slices
Frozen Roll/Muffin	1	1 muffin
	2	2 muffins
	3	3 muffins
	4	4 muffins
	5	5 muffins
	6	6 muffins
Fresh Roll/Muffin	1	1 muffin
	2	2 muffins
	3	3 muffins
	4	4 muffins
	5	5 muffins
	6	6 muffins

Category	Touch	Amount
Beverage	1	1 cup
	2	2 cups
Chicken Pieces	Enter Weight	0.5 to 2 lbs.
Hot Cereal	1	1 serving
	2	2 servings
	3	3 servings
	4	4 servings
	5	5 servings
	6	6 servings

CONTROL SETUP

CONTROL SETUP provides four modes which make using your microwave oven quite handy. You can select SOUND ON/OFF, CLOCK ON/OFF, SCROLL SPEED and LBS/KG.

Example: To turn off sound of beeper.

Touch:	Display Shows:
1. Clear	Time of day
2. Control Setup	Four modes show in the display
3. ①	SOUND ON TOUCH 1 OFF TOUCH 2
4. ②	SOUND OFF Time of day

NOTE: To turn beep sound back on, repeat steps 1-3, then touch number one.

Example: To switch from LBS to KG.

Touch:	Display Shows:
1. Clear	Time of day
2. Control Setup	Four modes show in the display
3. ④	LBS TOUCH 1 KG TOUCH 2
4. ②	KG Time of day

NOTE: To change to LBS, repeat steps 1-3 then touch number one.

CONTROL SETUP FUNCTION TABLE

CODE	OPTION	NUMBER	RESULT
①	SOUND ON/OFF	1	SOUND ON
		2	SOUND OFF
②	CLOCK ON/OFF	1	CLOCK ON
		2	CLOCK OFF
③	SCROLL SPEED	1	SLOW SPEED
		2	NORMAL SPEED
		3	FAST SPEED
④	LBS/KG	1	LBS
		2	KG

NOTE: When the power cord is first plugged in, the default settings are SOUND ON, CLOCK ON, NORMAL SPEED and LBS.

CUSTOM DEFROST

Three defrost sequences are preset in the oven. The custom defrost feature provides you with the best defrosting method for frozen foods. The cooking guide will show you which defrost sequence is recommended for the food you are defrosting.

For added convenience, the custom defrost includes a built-in beep mechanism that reminds you to check, turn over, separate, or rearrange the food in order to get the best defrost results. Three different defrosting levels are provided:

1. MEAT
2. POULTRY
3. FISH

Available weight is 0.1 - 6.0 lbs.

Example: To defrost 1.2 lbs of ground beef.

Touch:	Display Shows:
1. Clear	Time of day
2. Custom Defrost	MEAT TOUCH 1 POULTRY TOUCH 2 FISH TOUCH 3
3. 1	MEAT ENTER WEIGHT
4. 1 and 2 to enter weight	1.2 LBS TOUCH START
5. 	Time counting down and DEFROST will appear on the display.

NOTE: TURN FOOD OVER will appear on the display in the middle of the cycle and you will hear a beep.

NOTE: When you touch the START pad, the display changes to a defrost time count down. The oven will beep during the DEFROST cycle. At this time, open the door and turn, separate, or rearrange the food. Remove any portions that have thawed. Return frozen portions to the oven and touch START to resume the defrost cycle.

OPERATING TIPS

- For best results, remove fish, shellfish, meat, and poultry from its original closed paper or plastic package (wrapper). Otherwise, the wrap will hold steam and juice close to the foods, which can cause the outer surface of the foods to cook.
- For best results, roll your ground meat into a ball before freezing. During the DEFROST cycle, the microwave will signal when it is time to turn the meat over. Scrape off any excess frost from the meat and continue defrosting.
- Place foods in a shallow container or on a microwave roasting rack to catch drippings.

This table shows food type selections and the weights you can set for each type. For best results, loosen or remove covering on food.

1 lb DEFROST

This feature should be used only when defrosting one pound of frozen ground beef.

Example: To defrost 1 lb of Ground beef.

Touch:	Display Shows:
1. Clear	Time of day
2. 1 lb Defrost	Time counting down and DEFROST will appear on the display.

NOTE: TURN FOOD OVER will appear on the display in the middle of the cycle and you will hear a beep.

CUSTOM DEFROST TABLE

NOTE: Meat of irregular shape and large, fatty cuts of meat should have the narrow or fatty areas shielded with foil at the beginning of the defrost sequence.

Meat settings

FOOD	SETTING	AT BEEP	SPECIAL INSTRUCTIONS
BEEF			
Ground Beef, Bulk	MEAT	Remove thawed portions with fork. Turn over. Return remainder to oven.	Do not defrost less than 1/4 lb. Freeze in ball shape.
Ground Beef, Patties	MEAT	Separate and rearrange.	Do not defrost less than 2 oz. patties. Depress center when freezing.
Round Steak	MEAT	Turn over. Cover warm areas with aluminum foil.	Place in a microwave safe dish.
Tenderloin Steak	MEAT	Turn over. Cover warm areas with aluminum foil.	Place in a microwave safe dish.
Stew Beef	MEAT	Remove thawed portions with fork. Separate remainder. Return remainder to oven.	Place in a microwave safe dish.
Pot Roast, Chuck Roast	MEAT	Turn over. Cover warm areas with aluminum foil.	Place in a microwave safe dish.
Rib Roast	MEAT	Turn over. Cover warm areas with aluminum foil.	Place in a microwave safe dish.
Rolled Rump Roast	MEAT	Turn over. Cover warm areas with aluminum foil.	Place in a microwave safe dish.
LAMB			
Cubes for Stew	MEAT	Remove thawed portions with fork. Return remainder to oven.	Place in a microwave safe dish.
Chops (1 inch thick)	MEAT	Separate and rearrange.	Place in a microwave safe dish.
PORK			
Chops (1/2 inch thick)	MEAT	Separate and rearrange.	Place in a microwave safe dish.
Hot Dogs	MEAT	Separate and rearrange.	Place in a microwave safe dish.
Spareribs Country-style Ribs	MEAT	Turn over. Cover warm areas with aluminum foil.	Place in a microwave safe dish.
Sausage, Links	MEAT	Separate and rearrange.	Place in a microwave safe dish.
Sausage, Bulk	MEAT	Remove thawed portions with fork. Turn over. Return remainder to oven.	Place in a microwave safe dish.
Loin Roast, Boneless	MEAT	Turn over. Cover warm areas with aluminum foil.	Place in a microwave safe dish.

CUSTOM DEFROST TABLE (CONTINUED)

Poultry setting

FOOD	SETTING	AT BEEP	SPECIAL INSTRUCTIONS
CHICKEN Whole (up to 6 lbs) Cut-up	POULTRY	Turn over (finish defrosting breast side down). Cover warm areas with aluminum foil. Separate pieces and rearrange. Turn over. Cover warm areas with aluminum foil.	Place chicken breast-side up in a microwave safe dish. Finish defrosting by immersing in cold water. Remove giblets when chicken is partially defrosted. Place in a microwave safe dish. Finish defrosting by immersing in cold water.
CORNISH HENS Whole	POULTRY	Turn over. Cover warm areas with aluminum foil.	Place in a microwave safe dish. Finish defrosting by immersing in cold water.
TURKEY Breast (up to 6 lbs)	POULTRY	Turn over. Cover warm areas with aluminum foil.	Place in a microwave safe dish. Finish defrosting by immersing in cold water.

Fish setting

FOOD	SETTING	AT BEEP	SPECIAL INSTRUCTIONS
FISH Fillets Steaks Whole	FISH FISH FISH	Turn over. Separate fillets when partially thawed, if possible. Separate and rearrange. Turn over.	Place in a microwave safe dish. Carefully separate fillets under cold water. Place in a microwave safe dish. Run cold water over to finish defrosting. Place in a microwave safe dish. Cover head and tail with foil; do not let foil touch sides of microwave. Finish defrosting by immersing in cold water.
SHELLFISH Crab meat Lobster tails Shrimp Scallops	FISH FISH FISH FISH	Break apart. Turn over. Turn over and rearrange. Separate and rearrange. Separate and rearrange.	Place in a microwave safe dish. Place in a microwave safe dish. Place in a microwave safe dish. Place in a microwave safe dish.





DEFROSTING TIPS

- When using Auto Defrost, the weight to be entered is the net weight in pounds and tenths of pounds (the weight of the food minus the container).
- Before starting, make sure to remove any and all metal twist-ties that often come with frozen food bags, and replace them with strings or elastic bands.
- Open containers, such as cartons, before placing in the oven.
- Always slit or pierce plastic pouches or packaging.
- If food is foil wrapped, remove foil and place it in a suitable container.
- Slit the skin of skinned food, such as sausage.
- Bend plastic pouches of food to ensure even defrosting.
- Always underestimate defrosting time. If defrosted food is still icy in the center, return it to the microwave oven for more defrosting.
- The length of defrosting time varies according to how solidly the food is frozen.
- The shape of the package affects how quickly food will defrost. Shallow packages will defrost more quickly than a deep block.
- As food begins to defrost, separate the pieces. Separated pieces defrost more easily.
- Use small pieces of aluminum foil to shield parts of food such as chicken wings, leg tips, fish tails, or areas that start to get warm. Make sure the foil does not touch the sides, top, or bottom of the oven. The foil can damage the oven lining.
- For better results, let food stand after defrosting. (For more information on standing time, see the "Microwave Cooking Tips" section).
- Turn over food during defrosting or standing time. Break apart and remove food as required.

TWO-STAGE COOKING

For best results, some recipes call for different power levels during a cook cycle. You can program your oven for two power level stages during the cooking cycle.

Example: To set a 2-stage cook cycle.

- | Touch: | Display Shows: |
|--|--|
| 1. Cook Time | : ENTER COOKING TIME |
| 2. 
To set a 3 minute cook time for first stage. | 3:00
TOUCH START OR
POWER LEVEL |
| 3. Cook Power | 3:00
POWER 100
ENTER POWER LEVEL 0 TO 10 |
| 4. 
To set an 80% cook power for the first stage. | 3:00
POWER 80 TOUCH START |
| 5. Cook Time | : ENTER COOKING TIME |
| 6. 
To set a 7 minute cook time for second stage. | 7:00
TOUCH START OR
POWER LEVEL |
| 7. Cook Power | 7:00
POWER 100
ENTER POWER LEVEL 0 TO 10 |
| 8. 
To set a 50% cook power for the second stage. | 7:00
POWER 50 LEVEL 0 TO 10 |
| 9.  | Time counting down and
POWER 80
will appear in the display |

NOTE: You can program a 0 power second stage for standing time inside the oven.

10. When the first stage is over, you will hear two short tones as the oven begins the second cook stage.

MICROWAVE POWER LEVELS

For best results, some recipes call for different cook powers. The lower the cook power, the slower the cooking. Each number from 1 to 9 stands for a different percentage of full cook power.

The following chart gives the percentage of cook power each number pad stands for, and the cook power name usually used.

It also tells you when to use each cook power. Follow recipe or food package instructions if available.

COOK POWER	LEVEL	WHEN TO USE IT
100% of full power	High	<ul style="list-style-type: none"> •Boiling water. •Making candy. •Cooking poultry pieces, fish and vegetables. •Cooking tender cuts of meat. •Whole poultry.
9 = 90% of full power		<ul style="list-style-type: none"> •Reheating rice, pasta and vegetables.
8 = 80% of full power		<ul style="list-style-type: none"> •Reheating prepared foods quickly. •Reheating sandwiches.
7 = 70% of full power	Medium-High	<ul style="list-style-type: none"> •Cooking egg, milk and cheese dishes. •Cooking cakes and breads. •Melting chocolate.
6 = 60% of full power		<ul style="list-style-type: none"> •Cooking veal. •Cooking whole fish. •Cooking puddings and custard.
5 = 50% of full power	Medium	<ul style="list-style-type: none"> •Cooking ham, whole poultry and lamb. •Cooking rib roast and sirloin tip.
4 = 40% of full power		<ul style="list-style-type: none"> •Thawing meat, poultry and seafood.
3 = 30% of full power	Medium-Low, Defrost	<ul style="list-style-type: none"> •Cooking less tender cuts of meat. •Cooking pork chops, roast.
2 = 20% of full power		<ul style="list-style-type: none"> •Taking chill out of fruit. •Softening butter.
1 = 10% of full power	Low	<ul style="list-style-type: none"> •Keeping casseroles and main dishes warm. •Softening butter and cream cheese.
0 = 0% of full power	None	<ul style="list-style-type: none"> •Standing time.

NOTE: Once the cook time has been entered, you can also use the Cook Power pad as a second Kitchen Timer by entering "0" for the Cook Power. The oven will count down the cooking time you set without cooking.

Understanding *TrueCookPlus*®

HOW TO USE TrueCookPlus®

TrueCookPlus is a registered trademark of Microwave Science JV LLC. USA and world wide.

WHAT IS TrueCookPlus® ?

TrueCookPlus® is the first way ever developed to microwave cook using a code found on packaged food.

TrueCookPlus® SETUP

After unpacking and plugging in your TrueCookPlus® oven, take a few moments to tell TrueCookPlus® your zip code.

Example : Setup your ZIP code

Clear

1. Press the Clear button.



2. Press the TrueCookPlus® button three times.

3. Enter your five digit U.S. Post Office zip code.



4. Press the Start button.

Once TrueCookPlus® knows your zip code, every time you enter a TrueCookPlus® code, TrueCookPlus® will automatically adjust for your elevation above sea level.

NOTE: In case of a power failure, your zip code does not need to be reset. Your zip code is saved in the microwave oven memory. If the microwave oven is moved into a new zip code, the oven must be set up for the new zip code.

EXAMPLE: USING TrueCookPlus®

Clear

1. Press the Clear button.



2. Find the simple TrueCookPlus® code on your favorite food package or at <http://www.TrueCookPlus.com>. On your food package, your TrueCookPlus® code will appear on the TCP logo.



3. Press the TrueCookPlus® button on your microwave oven keypad.

4. You will hear a tone, then enter the TrueCookPlus® code on your microwave oven keypad.

1 2 3 4

5. For example, enter 1 2 3 4. The display shows:
[1 2 3 4 TOUCH START



6. Press the Start button.

7. TrueCookPlus® now manages your microwave cooking automatically. When TrueCookPlus® is done, you will hear a tone to indicate the cooking is done.

8. You must enter the TrueCookPlus® code exactly as it appears on the food package or at <http://www.TrueCookPlus.com>. If you enter an invalid TrueCookPlus® code, your oven will display **CODE ERROR**.



If you make a mistake while entering the numeric code or fail to press the TrueCookPlus® button before entering the code, your food may undercook, overcook or even burn.

Using *TrueCookPlus*®

CUSTOMIZING TrueCookPlus®

You may find that you prefer TrueCookPlus® to cook your food more or less.

TrueCookPlus® can adjust to your tastes - to cook your food hotter or cooler - automatically:

Example	
Clear	1. Press the Clear button.
	2. Press the TrueCookPlus® button twice.
1	3. If you want less cooking time when you enter a TrueCookPlus® code, press 1. This will decrease the time by 6%.
3 4 5	4. If you want more cooking time when you enter a TrueCookPlus® code: Press 3 for 3% more cooking time. Press 4 for 6% more cooking time. Press 5 for 9% more cooking time.
2	5. Press 2 to reset TrueCookPlus® to factory setting default time.
	6. Press the Start button.
Note:	
1: Shorter (6%)	
2: Normal (Default)	
3, 4 or 5: Longer (3%, 6%, 9%)	

Questions and Answers

QUESTIONS	ANSWERS
Can I operate my microwave oven without the turntable or turn the turntable over to hold a large dish?	No. If you remove or turn over the turntable, you will get poor cooking results. Dishes used in your oven must fit on the turntable.
Can I use either metal or aluminum pans in my microwave oven?	You can use aluminum foil for shielding (use small, flat pieces), small skewers, and shallow foil trays (if tray is no taller than 3/4 in. [1.9 cm] deep and is filled with food to absorb microwave energy). Never allow metal to touch walls or door.
Is it normal for the turntable to turn in either direction?	Yes. The turntable reverses rotation each time the microwave oven door is opened and closed. This helps cook food evenly.
Sometimes the door of my microwave oven appears wavy. Is this normal?	This appearance is normal and does not affect the operation of your oven.
What are the humming noises that I hear when my microwave oven is operating?	You may hear the sound of the transformer when the magnetron tube cycles on.
Why does the dish become hot when I microwave food in it? I thought that this should not happen.	As the food becomes hot it will conduct the heat to the dish. Be prepared to use hot pads to remove food after cooking.
What does "standing time" mean?	"Standing time" means that after the timed cooking period ends, food should be allowed to stand either inside or outside of the oven to completely finish cooking. Outside oven standing time will allow the oven to be available for other use. For inside oven standing time, you can program a "0" power second stage of the cooking cycle. See Two-Stage Cooking.
Why does steam come out of the air exhaust vent?	Steam is normally produced during cooking. The microwave oven has been designed to vent this steam.
Can I pop popcorn in my microwave oven? How do I get the best results?	Yes. Pop packaged microwave popcorn while following the manufacturer's guidelines. Do not use regular paper bags. Do not re-pop unpopped kernels. Do not pop popcorn in glass cookware.

Troubleshooting

Most cooking problems often are caused by little things that you can find and fix without tools of any kind. Check the lists below and on the next page before calling for assistance or service. If you still need help, call Sears Service at 1-800-4-MY-HOME.

MICROWAVE OVEN DOES NOT WORK

PROBLEM	CAUSE
Nothing works.	<ul style="list-style-type: none">•The power supply cord is not plugged into a grounded 3 prong outlet. (See the "Electrical Requirements" and "Electrical Connection" sections)•A household fuse has blown or a circuit breaker has tripped.•The electric company has had a power failure.
The microwave oven will not run.	<ul style="list-style-type: none">•You are using the oven as a timer. Touch STOP to cancel the Kitchen Timer.•The door is not firmly closed and latched.•You did not touch START.•You did not follow directions exactly.•An operation that you set earlier is still running. Touch STOP to cancel that operation.

COOKING TIMES

PROBLEM	CAUSE
Food is not cooked enough.	<ul style="list-style-type: none">•The electric supply to your home or wall outlets is low or lower than normal. Your electric company can tell you if the line voltage is low. Your electrician or service technician can tell you if the outlet voltage is low.•The cook power is not at the recommended setting.•Refer to Cooking Tip chart.
The display shows a time counting down but the oven is not cooking.	<ul style="list-style-type: none">•The oven door is not closed completely.•You have set the controls as a Kitchen Timer. Touch STOP to cancel the Kitchen Timer.

TURNTABLE

PROBLEM	CAUSE
The turntable will not turn.	<ul style="list-style-type: none">•The turntable is not correctly in place or the turntable could be in the turntable "OFF" mode. The glass plate should be correct-side up and sitting firmly on the center shaft.•The support is not operating correctly. Remove the turntable and restart the oven. If the support still does not move, call Sears Service at 1-800-4-MY-HOME®. Cooking without the turntable can give you poor results.

TONES

PROBLEM	CAUSE
You do not hear the programming or end-of-cycle tone.	<ul style="list-style-type: none">•You have not entered the correct command.

Get it fixed, at your home or ours!

Your Home

For troubleshooting, product manuals and home solutions advice:



www.managemylife.com

For repair - **in your home** - of **all** major brand appliances, lawn and garden equipment, or heating and cooling systems, **no matter who made it, no matter who sold it!**

For the replacement parts, accessories and owner's manuals that you need to do-it-yourself.

For Sears professional installation of home appliances and items like garage door openers and water heaters.

1-800-4-MY-HOME[®] (1-800-469-4663)

Call anytime, day or night (U.S.A. and Canada)

www.kenmore.com

www.sears.com

Our Home

For repair of carry-in items like vacuums, lawn equipment, and electronics, call anytime for the location of your nearest

Sears Parts & Repair Service Center

1-800-488-1222 (U.S.A.) **1-800-469-4663** (Canada)

www.kenmore.com

www.sears.com

To purchase a protection agreement on a product serviced by Sears:

1-800-827-6655 (U.S.A.) **1-800-361-6665** (Canada)

Para pedir servicio de reparación a domicilio, y para ordenar piezas:

1-888-SU-HOGAR[®]

(1-888-784-6427)

www.kenmore.com

Au Canada pour service en français:

1-800-LE-FOYER^{MC}

(1-800-533-6937)

www.sears.com

The Sears logo, featuring the word "Sears" in a large, bold, stylized serif font with a shadow effect.

® Registered Trademark / TM Trademark of KCD IP, LLC in the United States, or Sears Brands, LLC in other countries

® Marca Registrada / TM Marca de Fábrica de KCD IP, LLC en Estados Unidos, o Sears Brands, LLC in otros países

^{MC} Marqye de cinnerce / ^{MD} Marque déposée de Sear Brands, LLC.