

This Owner's Manual is provided and hosted by [Appliance Factory Parts](#).



SOLEUSAIR WA2-02-50 Owner's Manual

[Shop genuine replacement parts for SOLEUSAIR
WA2-02-50](#)



[Find Your SOLEUSAIR Water Cooler Parts - Select From 3 Models](#)

----- Manual continues below -----



Aqua Sub Easy Load Water Cooler

Model No: WA2-02-50



3092402

WA2-02-50

© 2009 Soleus Air International

Thank you for choosing a Soleus Air Water Cooler. This owner's manual will provide you with valuable information necessary for the proper care and maintenance of your new product. Please take a few moments to thoroughly read the instructions and familiarize yourself with all the operational aspects of your new water cooler.

For your own records, please attach a copy of your sales receipt to this manual. Also, write the store name/location, date purchased, and serial number below:

Store Name: _____

Location: _____

Date Purchased: _____

Serial Number (located on back of unit): _____

IMPORTANT SAFETY INSTRUCTIONS

When using electrical appliances, basic safety precautions should be followed to reduce the risk of fire, electric shock, and injury to persons or property. Read all instructions before using any appliance.

1. Do not let hot water touch bare skin. Keep combustible material such as furniture, bedding, pillows, clothes, and/or papers away from the back of the unit.
2. Do not operate this, or any other appliance, with a damaged power cord. No other appliance should be plugged into the same outlet. Be sure that the plug is fully inserted into the outlet.
3. Do not run the power cord over carpeting or other heat insulators. Do not cover the cord. Keep cord away from high traffic areas, and do not submerge in water.
4. We do not recommend the use of extension cord as it may overheat and cause a risk of fire.
5. Exercise caution and use reasonable supervision when the appliance is used by or near children.
6. Do not use your water dispenser outdoors. Place the water dispenser away from direct sunlight and make sure that there is at least 4 inches (10cm) of space between the back of your unit and wall. Keep a minimum of 2 inches (5cm) on each side of your unit free.
7. Do not use this product to dispense anything other than water.
8. To avoid a hazard due to instability of the appliance, it must be placed on even and flat surface.
9. If the supply cord is damaged, the manufacturer or its service agent or a similarly qualified person must replace it in order to avoid a hazard.
10. This water cooler must be positioned so that the plug is accessible.
11. Disconnect the plug from the outlet when not in use.
12. Remove power plug or disconnect from the main power source before servicing the appliance.

PLEASE SAVE THESE INSTRUCTIONS.

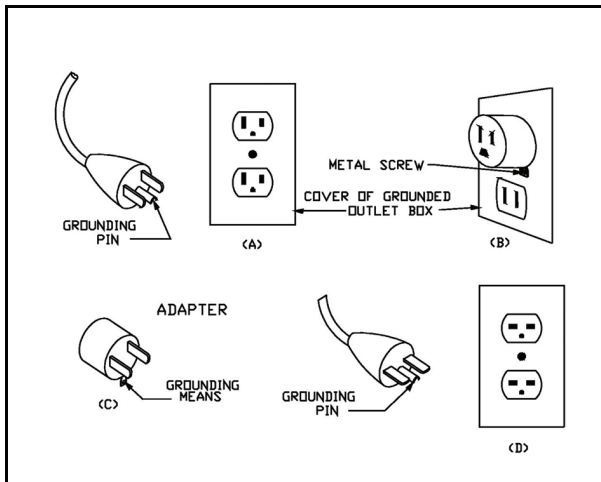

WARNING: This water cooler is for use on 120 volt outlets only. The cord has a plug as shown in A. An adapter as shown in C is available for connecting three-blade grounding-type plugs to two-slot receptacles. The grounding lug extending from the adapter must be connected to a permanent ground such as a properly grounded outlet box. The adapter should not be used if a three-slot grounded receptacle is available.

DO NOT DEFEAT THE SAFETY PURPOSE OF THE GROUNDED PLUG.

TECHNICAL SPECIFICATIONS

Model	WA2-02-50
Power Supply	115V, 60Hz
Electrical Rating	6.0 Amps, 580 Watts
Refrigerant and Quantity	R134a, 37g
Design Pressure (High Side)	188psig
Design Pressure (Low Side)	88psig
Dimensions	13.5"W x 17"D x 42" H

PRODUCT DIAGRAM

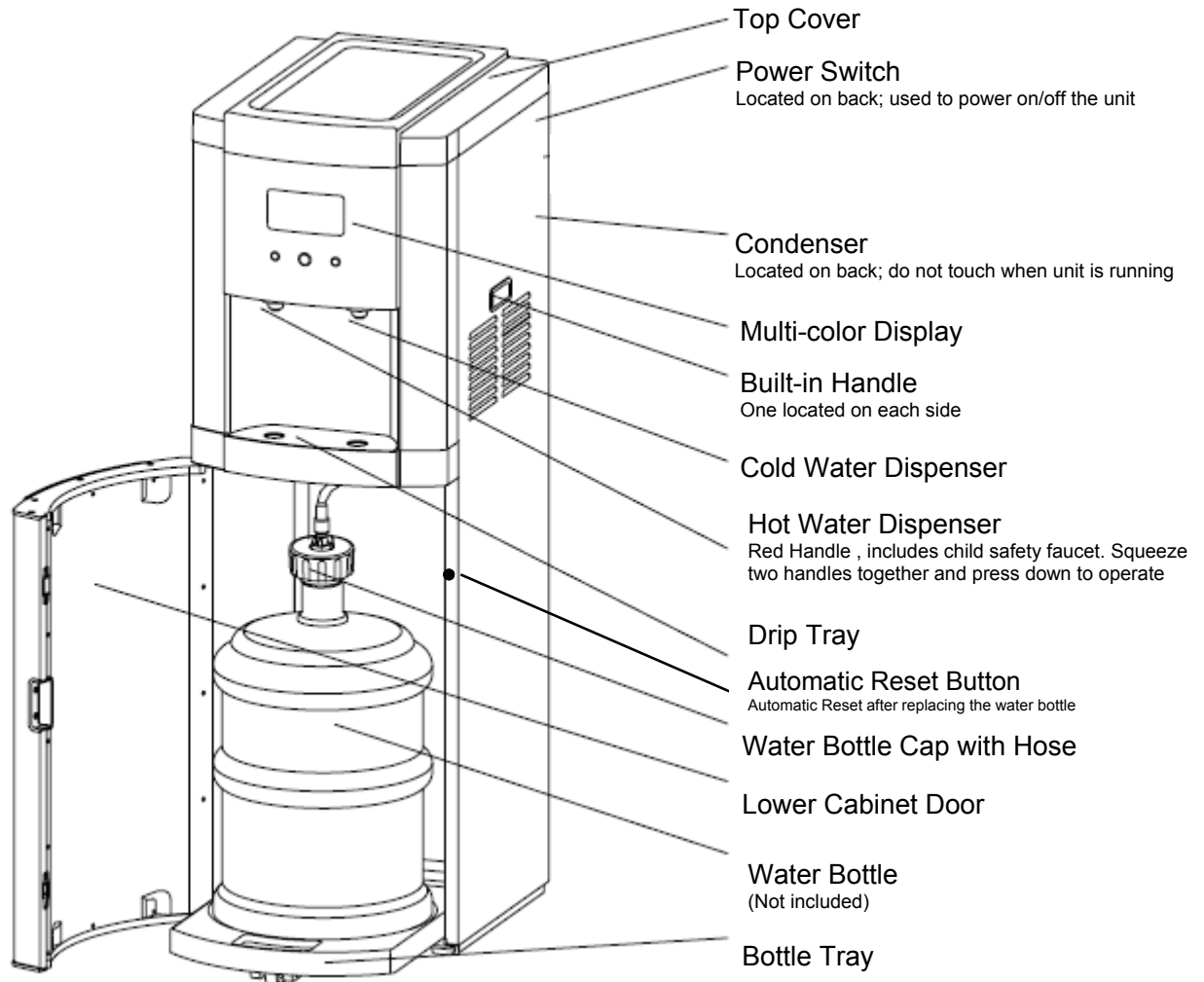

CONTROL PANEL AND MULTI-COLOR DISPLAY

CONTROL PANEL

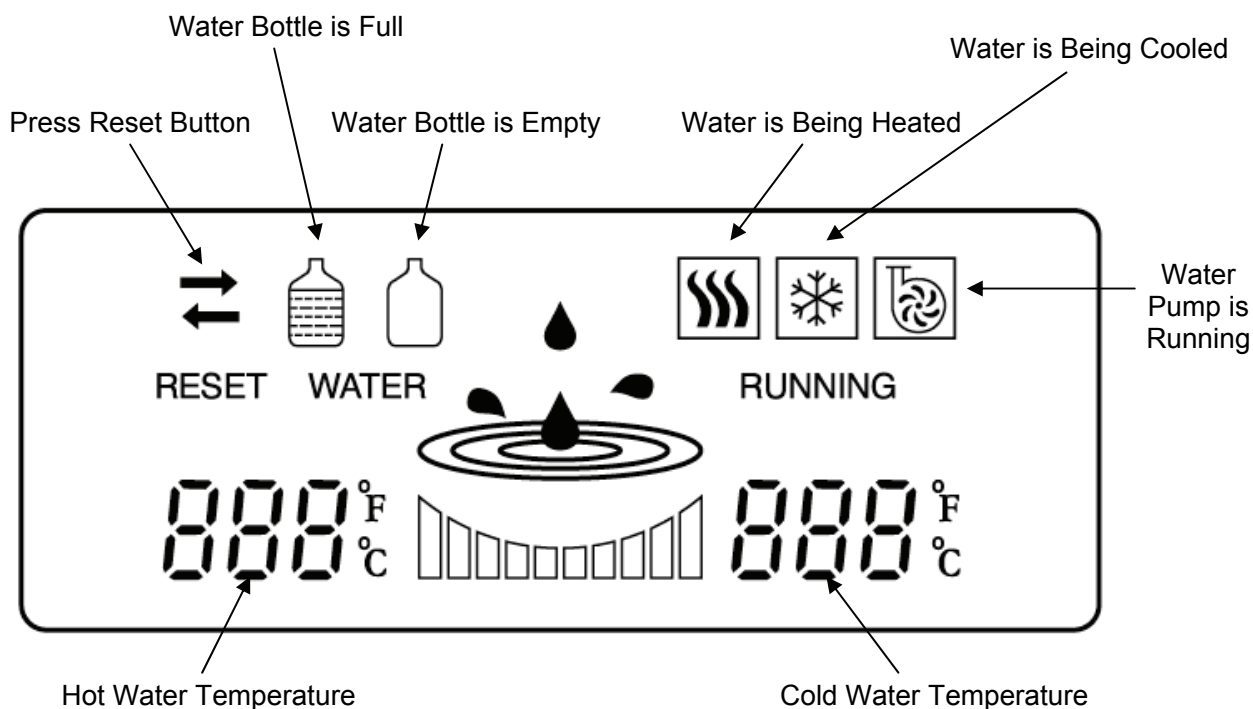
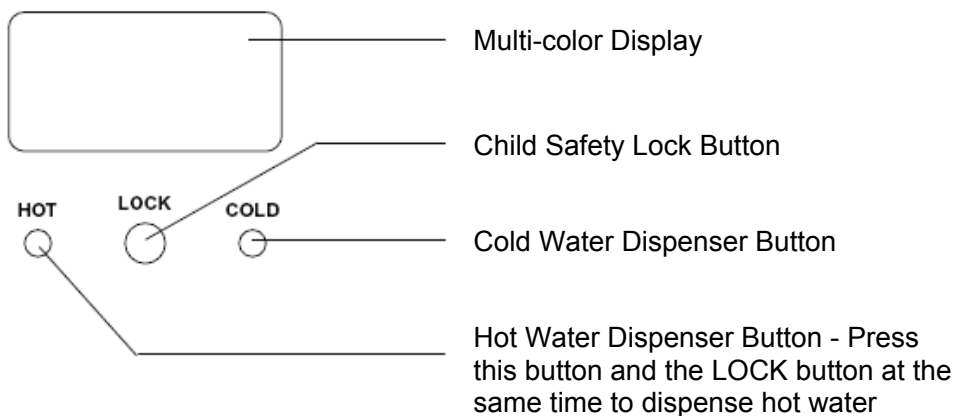

UNPACKING THE WATER COOLER

1. Cut and remove the straps from the box. **DO NOT** turn the box upside down, or lay it on its side. The bottom of the box is separate from the top section. Lift straight up on the top box section to remove the top box section. Remove the Styrofoam packaging and plastic bag. Lift the water cooler off the bottom of the box. Wipe it clean if necessary.
2. Place the machine on a hard, flat surface. Make certain the unit is level. The unit should not be close to direct sunlight or other source of heat.
3. It is best to place the water cooler in an area with good air circulation. Make sure there is at least 4 inches (10cm) of space between the back of your water cooler and the wall. Keep a minimum distance of 2 inches (5cm) on each side of your water cooler.

WARNING: The drain cap on the back of the unit may become loose during shipping. Fasten the drain cap tightly before you start to operate the unit. If the drain cap is loose, the unit may leak and cause floor damage.

PREPARING THE WATER COOLER FOR USE

The Aqua Sub is different from a traditional water cooler. The water bottle does not need to be placed upside down on the top of the unit. The water bottle is placed in the lower cabinet of the unit, and then a pump draws the water up to the dispenser.

Much like a new refrigerator with an ice maker or water dispenser, it is recommended to run 1 or 2 water bottles full of water through the system before use.

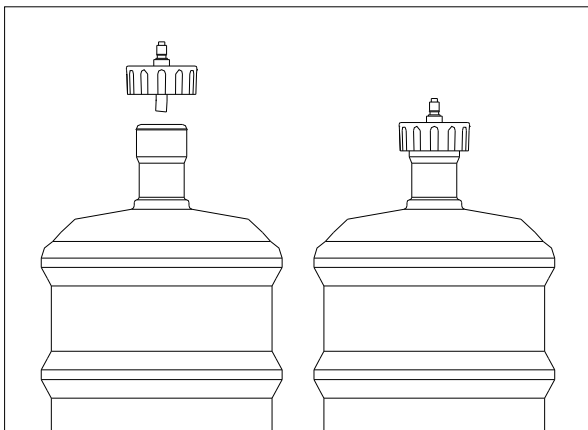

Figure 1

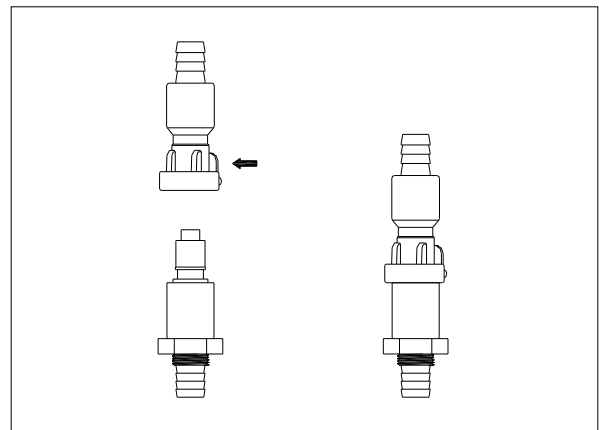
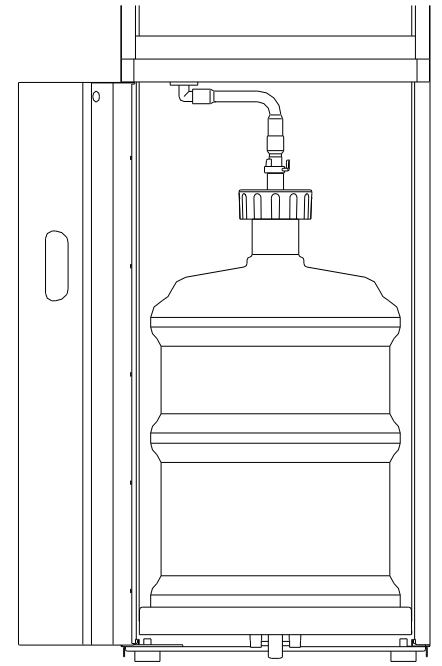

Figure 2

1. Make sure the water dispenser is not plugged into an electrical outlet.
2. Open the door of the lower cabinet and pull the tray out from the cabinet.
3. Place a full water bottle on the tray. Remove the plastic cover over the mouth of the water bottle.
4. Put the hose inside the water bottle and place the water bottle cap firmly over the mouth of the water bottle. (Figure 1)
5. Attach the hose to the water cooler by pressing in on the knob of the hose cap and sliding over the connector at the top of the cabinet. (Figure 2)
6. Push the tray inside the cabinet and close the lower cabinet door.
7. Plug the water cooler into a grounded power outlet and turn on the power switch located on the back.
8. The unit will start to operate, but you should wait at least half an hour before using the water cooler.



NOTE: If there is not a secure connection between the hose cap and the connector on the water cooler, the water pump will operate but the water cooler will not dispense water. Make sure the hose is connected to the water cooler correctly.

NOTE: Please wait until the water pump stops running before using the unit. If the water tank is not full, no water will dispense from the cold water faucet and the hot water faucet.

OPERATION

After the water bottle has been connected to the water cooler, the unit is ready for use. Turn the power switch on the back of the unit to ON. The water cooler will start running. First the unit will pump the water from the water bottle into the cooling and heating tanks, and then the unit's compressor and heater will start to operate. It will take approximately 30 minutes for the water cooler to provide hot and cold water when first plugged in to an outlet.

- **Cold Water** - To dispense cold water, press the **COLD** water button on the control panel.
- **Hot Water** - To dispense hot water, press the **HOT** water button and the **LOCK** button on the control panel.
- **Reset** - Once you have replaced an empty water bottle with a new full water bottle, the water cooler will reset itself and begin pumping water as soon as the door closes.

CLEANING & MAINTENANCE

1. To avoid accidents, turn off and unplug the water cooler from the outlet before cleaning.
2. A soft damp cloth may be used to clean the surface of the water cooler. When necessary, a mild detergent may be used. DO NOT use erosive chemical solvents to clean the unit, as this may damage the surface of the water cooler.
3. DO NOT pour water on the exterior of the unit to avoid getting the internal electrical system damp. DO NOT immerse the unit in water when cleaning.
4. The **water bottle cap, hose, and drip tray** may be washed in a dishwasher (**top rack only**).
5. Keep the water cooler 6 inches (15cm) away from the wall so it can work properly. Make certain all ventilation openings are clear of obstruction.
6. Do not damage the heating or cooling system, paying particular attention to the black condenser or heat radiator on the back of the water cooler.
7. If you will not use the water cooler for a long period of time, please unplug the power cord and drain the water cooler. Drain the water from all faucets, then remove the drain cap on back and allow it to drain. Make certain the drain cap is fastened tightly when finished.

TROUBLESHOOTING

Please check the troubleshooting chart below. It includes several common problems, which you can correct at home, making a customer service call unnecessary.

Problem	Possible Cause	Remedy
Unit does not dispense hot and cold water.	Unit is unplugged.	Plug the power cord into an outlet.
	Main power supply is off.	Reestablish main power supply.
	The hose cap is not attached properly to the connector on the water cooler.	Connect properly. There will be a give when the hose cap slides properly over the connector.
Unit does not dispense cold water.	The cold water thermostat is set at too high a temperature.	Adjust the thermostat.
	Over consumption of cold water in a short time.	Wait a moment for the water to cool.
	The ventilation around the unit is insufficient.	Space the unit from the wall by more than 15 cm.
	The temperature of water in the water bottle is too high. (When the bottle is exposed to direct sunlight for a long time.)	Place the water bottle in a cool location out of direct sunlight.
Unit does not dispense hot water.	Over consumption of hot water in a short time.	Wait a moment for the water to heat.
Unit is noisy during operation.	The appliance is not level.	Place the unit on a level, flat surface.
	Unit is touching other objects.	Move the unit away from other objects.
Water leaks from the faucet.	The top portion of the faucet has become loose.	Tighten the top threaded portion of the faucet.
	The faucet has been damaged.	Call the customer service telephone number to repair the faucet.
	The bottle may have small pinholes.	Replace with a new water bottle.
Water is dripping out of the water cooler and onto the floor.	The drain cap on the back is not fastened properly.	Tighten the drain cap. If the sealing silicon material inside the drain cap is torn or damaged, then replace with a new one.
The water being dispensed has a strange taste.	This is not uncommon with new water coolers. Do not worry, this is not dangerous to your health. This water cooler is FDA approved.	Clean the hose in the dishwasher (top rack only) or let it soak in dish soap. The strange taste usually goes away after the first bottle has been used up.

WARRANTY

One Year Limited Warranty

Soleus International Inc. warrants the accompanying Soleus Air Water Cooler to be free of defects in material and workmanship for the applications specified in its operation instruction for a period of ONE (1) year from the date of original retail purchase in the United States.

If the unit exhibits a defect in normal use, Soleus International Inc. will, at its option, either repair or replace it, free of charge within a reasonable time after the unit is returned during the warranty period.

As a condition to any warranty service obligation, the consumer must present this Warranty Certificate along with a copy of the original purchase invoice.

THIS WARRANTY DOES NOT COVER:

- Damage, accidental or otherwise, to the unit while in the possession of a consumer not caused by a defect in material or workmanship.
- Damage caused by consumer misuse, tampering, or failure to follow the care and special handling provisions in the instructions. This includes dents, accidental or otherwise, to the base and head of the unit.
- Damage to the finish of the case, or other appearance parts caused by wear.
- Damage caused by repairs or alterations of the unit by anyone other than those authorized by Soleus International Inc.
- Freight and Insurance cost for the warranty service.

ALL WARRANTIES, INCLUDING ANY IMPLIED WARRANTY OF MERCHANT ABILITY ARE LIMITED TO ONE-YEAR DURATION OF THIS EXPRESS LIMITED WARRANTY. **SOLEUS INTERNATIONAL INC.** DISCLAIMS ANY LIABILITY FOR CONSEQUENTIAL OR INCIDENTAL DAMAGES AND IN NO EVENT SHALL SOLEUS INTERNATIONAL INC'S LIABILITY EXCEED THE RETAIL VALUE OF THE UNIT FOR BREACH OF ANY WRITTEN OR IMPLIED WARRANTY WITH RESPECT TO THIS UNIT.

This warranty covers only new products purchased from our authorized dealers or retailers. It does not cover used, salvaged, or refurbished products.

As some states do not allow the limitation or exclusion of incidental or consequential damages, or do not allow limitation on implied warranties, the above limitations and exclusions may not apply to you. This warranty gives you specific legal rights, and you may also have other rights that vary from state to state.

For Technical Support & Warranty Service

Please Call (888) 876-5387

Or Write To:

Soleus International Inc.

20035 E Walnut Dr. North

City of Industry, CA 91789 USA

www.soleusair.com