

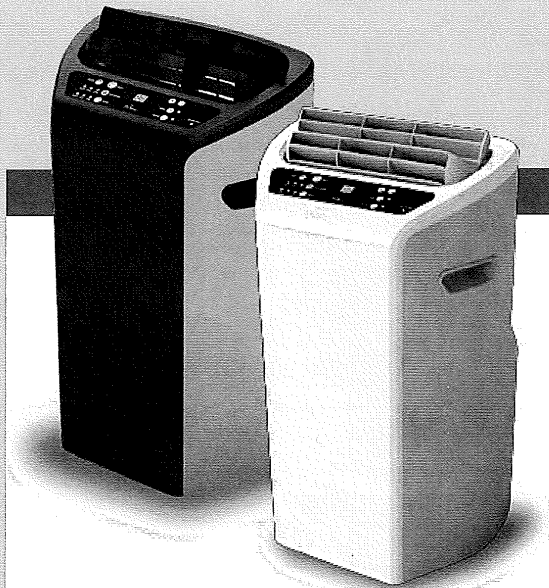

OWNER'S MANUAL

ARP-1400BLS, 1400WW
PORTABLE AIR CONDITIONER

ARP- 1400BLS, 1400WW



PORTABLE AIR CONDITIONER
ACONDICIONADOR DE AIRE PORTÁTIL

Página en Español 17
Page en Français 33

Read and retain these instructions for future reference

**For any Customer Support needs, please choose
the Support tab on www.royalsovereign.com**

Royal Centurian Inc.

PORTABLE AIR CONDITIONER

Model ARP-1400BLS, 1400WW

INTRODUCTION

Thank you for choosing Royal Sovereign to provide you and your family with all of the "Home Comfort" requirements for your home, apartment, or office. This Portable Air Conditioner can be set-up in just minutes and can be easily moved from room to room. It is a multi-functional room air comfort system that offers you Air Conditioning, Dehumidification and Air Circulation modes. This manual will provide you with valuable information necessary for the proper care and maintenance for your new appliance. Please take a few moments and read the instructions thoroughly. If properly maintained, your appliance will give you many years of troublefree operation.

CONTENTS

	Page
Precautions for use	4
Notes on operation and identification of parts	5
Installation instructions	6~7
Operation	8~9
Remote control	10~11
Maintenance	12
Troubleshooting	13
Specifications	14
Warranty	15
Contact information	16
Página en Español	17
Page en Français	33



PRECAUTIONS FOR USE

Electrical Specifications and Power Cord

Check to ensure that the electrical service being used is adequate for the model you've chosen. The electrical rating of your new air conditioner is defined on the serial plate of the unit. Please refer to the rating when checking electrical requirements to ensure they meet the electrical codes of your location.

- Install the air conditioner according to the installation instructions supplied.
- Do not modify any part of this product.
- Do not insert any objects into the product or block the airflow in any way.
- Ensure that the power supply you use has an appropriate voltage rating.
- Only use a properly installed 3 pin, grounded AC socket that is rated 115V, 60Hz, 15 amps or more.
- If the electrical outlet you intend to use is not adequately grounded or protected by a time delay fuse or circuit breaker, you should have a qualified electrician install the proper outlet.
- This unit uses a plug with a built-in fuse. Conduct a Power Plug Check (see page 9) before use to confirm normal operation.
- **Do not use this unit with any extension cords or adapter plugs.**
- If the cord or plug is damaged in any way, please call the Royal Sovereign Service Department (see page 16.)
- Do not plug this cord into a loose electrical outlet.
- Turn the unit off and unplug, when cleaning the air conditioner, removing the filter or when the air conditioner will not be used for an extended time period.

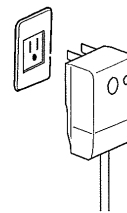

General Use

- Do not block air outlets or intake with obstacles.
- Do not insert any objects into the air conditioner.
- Do not splash or pour water on the housing or control panel.
- Do not place heavy items or sit on unit.
- Make sure the drainage plug is installed on bottom of machine.
- Drain the unit when moving the air conditioner or when storing the unit.

NOTES ON OPERATION

If you turn the air conditioner off and immediately restart it, allow 3 minutes for the compressor to restart cooling. In the event of a power failure, wait 3 minutes before restarting unit.

IDENTIFICATION OF PARTS

1. Air outlet
2. Display panel
3. Air intake (evaporator)
4. Air inlet hose
5. Air filter
6. Air outlet hose(heat exchange)
7. Water outlet drain
8. Caster
9. Power supply cord

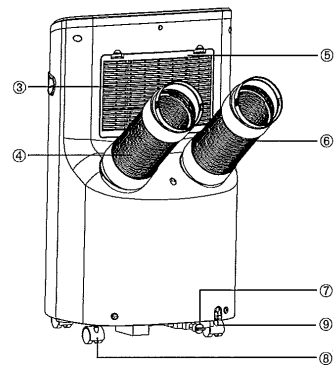
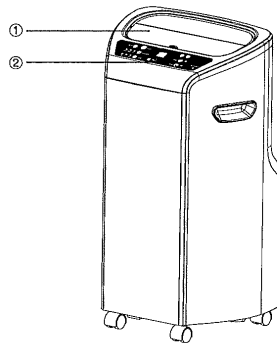



INSTALLATION

Unpack your New Portable Air Conditioner and let the machine stand upright for 2 hours before starting.
Unpack all parts listed below. If any parts are missing do not return this product to the place of purchase.
Please visit our website www.royalsovereign.com and click on the "Support" tab .

Accessories Include

- 1. Window slider kit..... 3 Set
- 2. Fixture..... 2 Piece
- 3. Screws..... 8 Pieces
- 4. Exhaust hose connector 4 Pieces
- 5. Exhaust hose..... 2 Piece
- 6. Cover..... 2 Piece

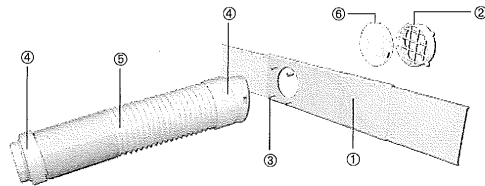

A. Exhaust Hose and Connector : Fig 1.

- 1. Attach the threaded nozzles of exhaust hose connector to the end of the exhaust hose by turning clockwise.
- 2. Repeat for other end.

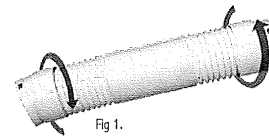

Fig 1.

B. Attach Hose Fixture : Fig 2.

- 1. Line up the screw holes on the hose fixture to the front of the window slider kit.
- 2. Using the 8 screws provided, attach the hose fixtures to the window panel of the slider kit.

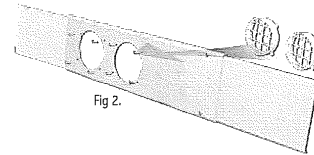
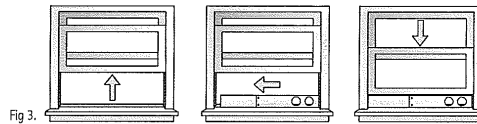

Fig 2.

ARP-1400BLS, 1400WW

C. Install the Window Slider Kit : Fig 3.

1. Open the window and place the window slider kit on the inside edge of the window.
2. Adjust the window slider by adjusting it to the width of the window.
3. Close the window to secure.
4. Tighten the four screws to lock the window slider in place.



D. Connecting the Exhaust Hose to the PAC : Fig 4.

1. Connect the hose connector to the air outlet by aligning the tabs on the hose to the PAC and snap it into place.
2. Repeat for other hose.

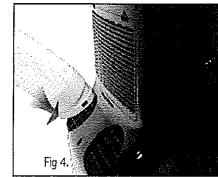

E. Connect the Exhaust Hose to Window Slider Kit : Fig 5.

1. Move the Portable Air Conditioner within 4 feet of the window.
2. Extend hose to desired length by pulling open.
3. Align the tabs on the hose and the window panel fixture and snap them into place.

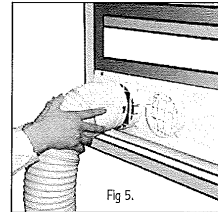

• Do not use this unit with any extension cords or adapter plugs.

Operation

Control Panel

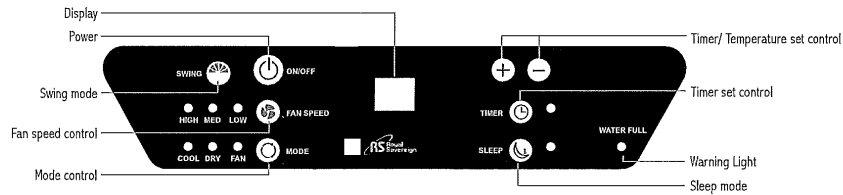

Power Control

The power control turns the unit on and off. When you press the control, the unit begins to operate.

Warning Light

Condensed water may accumulate in the unit. If the internal tank fills, the Warning Light will shine and the unit will not operate until the unit has been drained.

Mode Control

The Mode Control has 3 settings: Cool → Dehumidify → Fan → Cool

The settings are adjusted with the Mode Control button. The green light will indicate which setting is currently being used.

Fan Mode

When the fan mode is selected, the indicator light will shine green. The Air is circulated throughout the room with no cooling.

Swing Mode

The oscillation feature moves the air louvers from left to right to allow the air to reach more areas in the room. Press the SWING button to start this feature.

Sleep Mode

By pressing sleep button, the set temperature will increase 2°F/1°C in the first hour, another 2°F/1°C in the second hour and then remains at that temperature.

Dehumidify / Dry Mode

Press the Mode button to select dehumidify mode. When the dehumidify mode is on, the temperature buttons and fan speed buttons do not function and the fan will operate on medium speed. The dehumidify indicator light will illuminate and stay solid while unit is dehumidifying.

Cool Mode

When in Cool mode the indicator light will shine green.

1. During operating, the unit displays "present room temperature."
2. When setting the temperature, the unit will display the temperature set. Temperature range is 61°F to 89°F
3. In Cool mode, use the "+" or "-" button to adjust and set the desired temperature for the room. After 5 seconds the display will revert back to the current room temperature. Temperature can only be adjusted in Cool mode. The time is adjustable between 1~24 hours.

Fan Speed Control

The Fan speed has 3 settings: High, Medium, and Low

Changing Temperature Reading from Celsius to Fahrenheit

Press the Timer and Temperature set buttons at the same time to display the temperature reading you would like to use.

Timer

There are 2 different timer programs. You can set the number of hours before the air conditioner automatically turns OFF or you can set the number of hours that will elapse before the unit turns ON.

When the air conditioner is turned off, you can choose to turn it on in one hour intervals.

1. Press the  button on the remote to turn on the timer function
2. Press the + or - button on the remote to set the desired hour.
3. The unit will turn on when the set time elapses.

When the air conditioner is turned on, you can choose to turn it off in one hour intervals.

1. Press the  button on the remote to turn on the timer function
2. Press the + or - button on the remote to set the desired hour.
3. The unit will turn off when the set time elapses.

Automatic Restart:

In the event of a power failure: The settings will return to the previously set operating modes once the power is restored.

Power Plug Check

1. Press the RESET button.
2. Insert the power plug into the electrical outlet.
3. Press the TEST button. If the circuit breaker is working you'll hear a click.
4. Press the RESET button until you hear another click. The circuit breaker in the plug is now activated.
5. Do not use the air conditioner if the above procedure cannot be successfully performed.

After switching the air conditioner off, wait 3 minutes before switching it back on again.

Remote Control

The functions of the remote work the same as your air conditioner's touch controls.

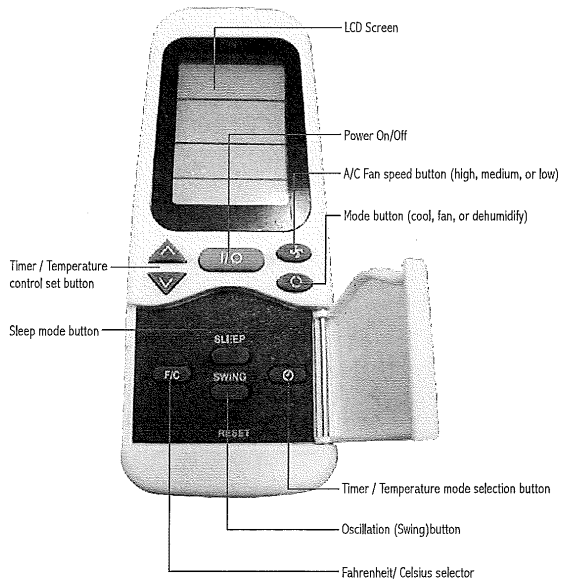

Timer Program

There are 2 different timer programs. You can set the number of hours before the air conditioner automatically turns OFF or you can set the number of hours that will elapse before the unit turns ON.

When the air conditioner is turned off, you can choose to turn it on in one hour intervals.

1. Press the button on the remote to turn on the timer function.
2. Press the or button on the remote to set the desired hour.
3. The unit will turn on when the set time elapses.

When the air conditioner is turned on, you can choose to turn it off in one hour intervals.

1. Press the button on the remote to turn on the timer function.
2. Press the or button on the remote to set the desired hour.
3. The unit will turn off when the set time elapses.

Oscillating Mode

Press the (SWING) button on the remote control to oscillate air movement from left to right and right to left.

Dehumidification Mode

Press the Mode button to select dehumidify mode. When the dehumidify mode is on, the temperature buttons and fan speed buttons do not function and the fan will operate on medium speed. The dehumidify indicator light will illuminate and stay solid while unit is dehumidifying.

Fahrenheit/ Celsius selector

Press the Fahrenheit/ Celsius selector button to display temperature reading you would like to use.

ARP-1400BLS, 1400WW

Remote Control Operation

- The remote control uses two AAA (IEC RO# 1.5V) batteries which have been included for your convenience.
- Remove the battery cover on back of the remote.
- Insert the batteries, making sure the (+) and (-) polarity is aligned correctly.
- Replace the battery cover.

Notes:

- When replacing batteries, always change both batteries at the same time.
- Remove the batteries if the remote control is not used for a month or longer.
- Do not dispose of batteries in a fire.

Battery replacement

Remove the cover on the back of the remote control and insert the batteries with (+) and (-) poles pointing in the proper direction.

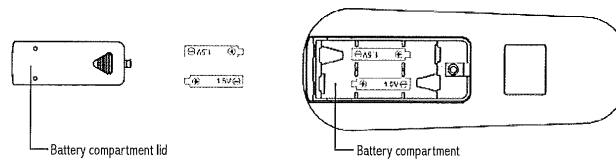



MAINTENANCE

Drainage

Occasionally, you may need to drain the unit.

1. Drain the unit if the Warning Light on the display panel of the air conditioner is on.
2. Turn off the power to the unit and unplug.
3. Place a shallow dish under the drainage plug to collect water.
4. Remove the drainage plug.
5. Replace the plug, when drainage water stops flowing.

Cleaning the filter

The filter should be cleaned every 2 weeks or 100 hours of use in order to maintain proper airflow.

1. Remove the filter. Gently pull the filter assembly from the back of the unit and then remove the filter from the assembly.
2. Clean the filter by vacuuming or a soft cloth. If the filter is very dirty, it can be easily washed with a mild detergent and rinsed thoroughly with clean water. Dry the filter before replacement.
3. Reinstall the filter in the filter assembly.
4. Replace the filter assembly on the back of the machine.

Note : Never operate the air conditioner without the filter in place. This may damage the unit.

Cleaning and maintaining the air conditioner

Turn the air conditioner off and remove the electrical plug. Wipe with a soft, dry, or damp cloth. A mild detergent can be used. Be sure to remove any residue and dry completely. Do not use harsh chemicals, abrasive cleaners or volatile substance (such as gasoline). Avoid splashing water on the air conditioner as this can seriously damage the unit.

Storing the air conditioner

If the unit will not be used for a long time, be sure to drain the air conditioner, clean the air filter, pull out the power supply plug, and remove the batteries from the remote control before storage. After draining, keep the air conditioner running on FAN mode for at least 8 hours to dry the unit completely to prevent mold.

TROUBLESHOOTING

Problem	Possible Reasons
Air Conditioner does not operate	<ul style="list-style-type: none"> - Check and reset the power plug. Wait 3 minutes and try to run the unit again. - The batteries in the remote may need to be replaced. Replace the batteries and try to run the unit again. - Make sure the plug is properly plugged into the outlet. - The set temperature may be too close to room temperature. Lower the set temperature. - The air outlet may be blocked. Check the air outlet and remove any items that may be found.
Air Conditioner runs but does not cool	<ul style="list-style-type: none"> - Check the room for open doors or windows and close them. - There may be another appliance in the room giving off heat. Check the room and turn off the appliance. - The air filter may be dirty. Check the filter and clean if necessary. - The air exhaust or intake may be blocked. - The set temperature may be too high. Check the set temperature and reduce it if necessary.
Air Conditioner does not run and water full indicator is lit	<ul style="list-style-type: none"> - There may be excess water in the unit. Drain the unit.



SPECIFICATIONS

- Figures noted in the contents are for reference only; variation may result due to the application in different countries or regions, and shall be based on practical operation.

Description of product	Air Conditioner
Model	ARP-1400BLS, 1400WW
Voltage/Frequency	AC 115V~60Hz
Input power	1700W
Current	15A
Cooling Capacity	13,500BTU/hr
Dehumidifying Capacity	100.8 pints/day
Coolant	R-22
Timer	24 hour
Dimension (w) X (h) x (d)	18.8 x 33.4 x 17.1 inches
Weight	77lbs

"Electrical waste products should not be disposed of with household waste.
Please recycle where facilities exist. Check with your local authority or retailer for recycling advice."



ARP-1400BLS, ARP-1400WW

REFURBISHED PORTABLE AIR CONDITIONER – 90 DAY WARRANTY

Royal Sovereign warrants each Portable Air Conditioner to be free from defects in material and workmanship. Our obligation under this warranty is limited to the repair or replacement, free of charge, when delivered to an authorized Royal Sovereign service center, of any defective part(s) thereof, other than parts damaged in transit. This warranty is in effect to the original purchaser, for a period of 90 days from the date of purchase and is not transferable. This warranty shall apply only if the air conditioner is used on Alternating Current (AC) circuit, in accordance with the factory provided instructions which accompany it.

To request services, please go to www.royalsovereign.com - Customer Support to submit a request or call 1-800-397-1025

EXCLUSIONS

This warranty excludes and does not cover defects, malfunctions or failures of your Royal Sovereign Portable Air Conditioner, caused by repairs by unauthorized persons or service centers, mishandling, improper installation, modification or unreasonable use including incorrect voltage, acts of God, or failure to provide reasonable and necessary maintenance. This warranty is in lieu of any and all expressed warranties. In no event shall Royal Sovereign be liable for consequential or incidental damages. This limitation would not apply if you live in a location that does not permit the exclusion of limitation of incidental or consequential damages. This warranty gives you specific legal rights and you may also have other rights which vary from state to state.

Please visit www.royalsovereign.com - USA - Customer Support for out of warranty service or to view frequently asked questions.

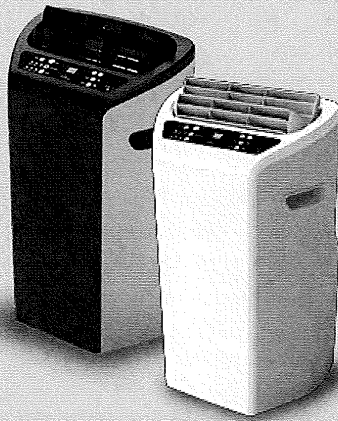

ROYAL SOVEREIGN INTERNATIONAL, INC.
2 Volvo Drive Rockleigh, NJ 07647 USA
TEL : +1) 800-397-1025 FAX : +1) 201-750-1022

ROYAL SOVEREIGN INC.
1001, World Meridian II, 426-5, Gasan-dong, Gancheon-gu, Seoul, 153-759, KOREA
TEL : +82)2-2025-8800 FAX : +82)2-2025-8830

RS INTERNATIONAL AUSTRALIA PTY. LTD.
30 Prime Drive, Seven Hills, NSW 2147, AUSTRALIA
TEL : +61) 2-9674-2127 FAX : +61) 2-9674-2027

RS CANADA INC.
1025 Westport Cresc. Mississauga ON L5T 1E8
TEL : +1) 905-461-1095 Fax : +1) 905-461-1096

RS Holland B.V.
Industrieweg 6R, 4104AR, Culemborg, The Netherlands
Tel : +31 (0)345 473 097 Fax : 31 (0)345 519 811

Royal Sovereign Mexico, S.A. de C.V.
24 de Abril de 1860 No. 8 Col. Leyes de Reforma Mexico D.F. C.P. 09310
Tel : +52) 55-5600-0757, 55-5600-7848 Fax : +52) 55-5600-0748