

This Owner's Manual is provided and hosted by [Appliance Factory Parts](#).

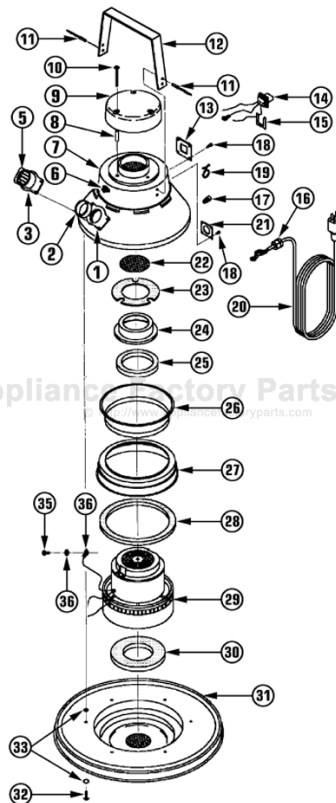

# SOOTMASTER 660M Owner's Manual

[Shop genuine replacement parts for SOOTMASTER  
660M](#)



[Find Your SOOTMASTER Vacuum Cleaner Parts - Select From 6 Models](#)

----- Manual continues below -----

**SAVE THESE INSTRUCTIONS**

**SOOTMASTER®**



**FURNACE DRY  
VACUUM CLEANERS**

**SAFETY, OPERATION  
& MAINTENANCE  
MANUAL  
W/PARTS LIST**

*This unit is intended for commercial Use.*

**READ AND FOLLOW ALL INSTRUCTIONS,  
WARNINGS & CAUTIONS BEFORE USING THIS  
VACUUM CLEANER**

This vacuum cleaner will afford you many years of trouble-free operating satisfaction, provided it is given proper care. All parts have passed rigid quality control standards prior to being assembled to produce the finished product. Prior to packaging, the vacuum was again inspected for assurance of flawless assembly.

Your vacuum is protectively packed to prevent damage in shipment. We recommend that upon delivery, unpack the vacuum and inspect it for any possible

damage. Only a visual examination will reveal damage that may have occurred.

If damage is discovered, immediately notify the transportation company that delivered your vacuum. As a shipper, we are unable to report claims for concealed damage. You must originate any claims within 5 days.

This manual is for your protection and information. **PLEASE READ CAREFULLY** since failure to follow precautions could result in discomfort or injury.

**PLEASE READ  
CAREFULLY  
BEFORE  
OPERATING**

Treat this vacuum as you would any other high grade precision made product. Dropping, unreasonable bumping across thresholds and other misuses may result in a damaged unit which will not be covered by warranty.

When not in use, power cord should be wrapped around the motor head for storage.

Read this manual completely before operating the vacuum. It is important to follow instructions in this manual to prevent the possibility of injury or damage to the user and/or vacuum.

**CARE OF THIS  
VACUUM CLEANER**

# IMPORTANT SAFETY INSTRUCTIONS

## WARNING



**To Reduce the Risk of Fire, Electric Shock or Injury:  
Dry Vacuums  
Electric shock could occur if used on wet surfaces.  
DO NOT expose to rain - Store Indoors**

When using this electric vacuum, basic precautions should always be followed, including the following:

- 1) **DO NOT** leave the vacuum when plugged in. Unplug it from the outlet when not in use and before servicing.
- 2) This is **NOT** a toy. Close attention is necessary when used around or near children.
- 3) Use only as described in this safety manual. Use only manufacturer's recommended attachments and accessories.
- 4) **DO NOT** use this vacuum with damaged cord or plug. If the vacuum is not working as it should, because it has been dropped, damaged, left outdoors or dropped into water, contact an authorized service center or factory.
- 5) **DO NOT** pull the vacuum by the cord, use cord as a handle, close a door on the cord or pull cord around sharp edges and corners. **DO NOT** run the vacuum over the cord. Keep cord away from heated surfaces.
- 6) **DO NOT** handle the vacuum plug or the vacuum with wet hands.
- 7) **DO NOT** unplug the vacuum by pulling on the cord. To unplug, grasp the plug, not the cord.
- 8) **DO NOT** put any objects into openings. **DO NOT** use with any openings blocked; keep free of dust, lint, hair, and anything that may reduce air flow.
- 9) Keep hair, loose clothing, fingers, and all parts of body away from the openings and moving parts.
- 10) **DO NOT** pick up anything that is smoking or burning such as cigarettes, matches, or hot ashes.
- 11) **DO NOT** use without dust bag and/or filters in place.
- 12) Turn **OFF** all the controls before unplugging.
- 13) **DO NOT** use where anesthetics or oxygen is used.
- 14) Use extra care when cleaning on stairs.
- 15) **DO NOT** use this vacuum to pick up flammable or combustible liquids such as gasoline or use in areas where they may be present.
- 16) Replace damaged or worn parts immediately with genuine original equipment parts to maintain safety and to protect your limited warranty.
- 17) **DO NOT** use an extension cord unless absolutely necessary. If an extension cord is used, then the wire size must be #14 gauge or larger and should not exceed 50 feet in length. The extension cord must be three-wire type to insure **GROUNDING** protection.

This vacuum must be connected to a properly grounded outlet only. See grounding instructions below. If your vacuum has an outlet for a motorized power nozzle, always turn it **OFF** before connecting or disconnecting the motorized nozzle.

## DANGER

**Improper use of the grounding plug can result in a risk of electric shock.**

## GROUNDING INSTRUCTIONS

Electrical equipment must be grounded. If it should malfunction or breakdown, grounding provides a path of least resistance for electrical current to reduce the risk of electric shock. This vacuum is equipped with a cord having an equipment-grounding conductor and grounding plug. The plug must be inserted into an appropriate outlet that is properly installed and

grounded in accordance with all local codes and ordinances.

If repair or replacement of the cord or plug is necessary, **DO NOT** connect the grounded wire to either flat blade terminal. The wire with insulation having an outer surface that is green with or without yellow stripes is the grounding wire.

## GROUNDING METHODS

This electric equipment is for use on a nominal 120 volt circuit, and has a grounded plug that looks like the plug illustrated in (Fig A). A temporary adaptor that looks like the adaptor illustrated in (Fig B & C) may be used to connect this plug to a 2-pole receptacle as shown in (Fig B) if a properly grounded outlet is not available.

The temporary adaptor should be used only until a properly grounded outlet (Fig A) can be installed by a qualified electrician. The green color rigid ear, lug or the like extending from the adaptor must be connected to a permanent ground such as a properly grounded outlet box cover. Whenever the adaptor is used, it must be held in place by a metal screw. (Fig C)

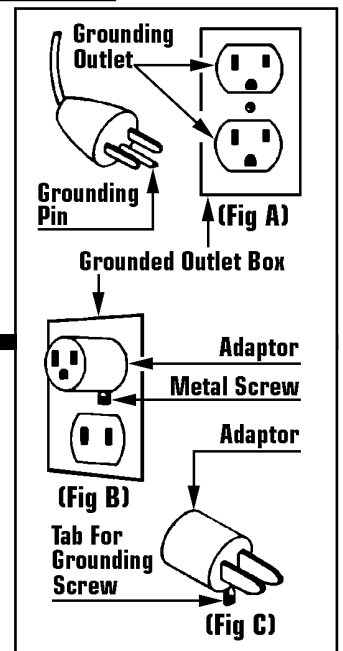

## WARNING

Improper connection of the equipment-grounding conductor can result in risk of electric shock. Check with qualified electrician or service person if you are in doubt as to whether the outlet is properly grounded. **DO NOT** modify the plug provided with the equipment. If it will not fit the outlet, have a proper outlet installed by a qualified electrician.

**Note:** In Canada, the use of a temporary adaptor is not permitted by the Canadian Electrical Code.

## LIRE TOUTES LES INSTRUCTIONS AVANT DE FAIRE FONCTIONNER (CET APPAREIL)

### AVERTISSEMENT:

Pour réduire les risques d'incendie, de choc électrique ou de blessure:

#### POUR APPAREIL SEC

Pour réduire les risques de choc électrique, ne pas aspirer de matières humides, ne pas exposer à la pluie et garder l'aspirateur à l'intérieur.

*L'utilisation d'un appareil électrique demande certaines précautions:*

1. Ne pas laisser l'appareil sans surveillance lorsqu'il est branché. Débrancher lorsque l'appareil n'est pas utilisé et avant l'entretien.

2. Ne pas permettre aux enfants de jouer avec l'appareil. Une attention particulière est nécessaire lorsque l'appareil est utilisé par des enfants ou à proximité de ces derniers.

3. N'utiliser que conformément à cette notice avec les accessoires recommandés par le fabricant.

4. Ne pas utiliser si le cordon ou la fiche est endommagé. Retourner l'appareil à un atelier de réparation s'il ne fonctionne pas bien, s'il est tombé ou s'il a été endommagé, oublié à l'extérieur ou immergé.

5. Ne pas aspirer de matières en combustion ou qui dégagent de la fumée, comme des cigarettes, des allumettes ou des cendres chaudes.

6. Ne pas tirer, soulever ou traîner l'appareil par le cordon. Ne pas utiliser le cordon comme une poignée, le coincer dans l'embrasure d'une porte ou l'appuyer contre des arêtes vives ou des coins. Ne pas faire rouler l'appareil sur le cordon. Garder le cordon à l'écart des surfaces chaudes.

7. Ne pas débrancher en tirant sur le cordon. Tirer plutôt la fiche.

8. Ne pas toucher la fiche ou l'appareil lorsque vos mains sont humides.

9. N'insérer aucun objet dans les ouvertures. Ne pas utiliser l'appareil lorsqu'une ouverture est bloquée. S'assurer que de la poussière, de la peluche, des cheveux ou d'autres matières ne réduisent pas le débit d'air.

10. Ne pas utiliser l'appareil si le sac à poussière ou le filtre n'est pas en place.

11. Maintenir les cheveux, les vêtements amples, les doigts et toutes les parties du corps à l'écart des ouvertures et des pièces mobiles.

12. Mettre toutes les commandes à la position ARRET avant de débrancher l'appareil.

13. User de prudence lors du nettoyage des escaliers.

14. Ne pas aspirer des liquides inflammables ou combustibles, comme de l'essence, et ne pas faire fonctionner dans des endroits où peuvent se trouver de tels liquides.

15. Toujours mettre l'interrupteur de l'appareil à la position ARRET avant de brancher ou de débrancher la brosse à moteur.

16. Ne brancher qu'à une prise de courant avec mise à la terre. Voir les instructions visant la mise à la terre.

## INSTRUCTIONS VISANT LA MISE À LA TERRE

Cet appareil doit être mis à la terre. En cas de défaillance ou de panne éventuelles, la mise à la terre fournit au courant un chemin de moindre résistance qui réduit le risque de choc élec-

trique. Cet appareil est pourvu d'un cordon muni d'un conducteur de terre et d'une fiche avec broche de terre. La fiche doit être branchée dans une prise appropriée correctement installée et

mise à la terre conformément aux règlements et ordonnances municipaux.

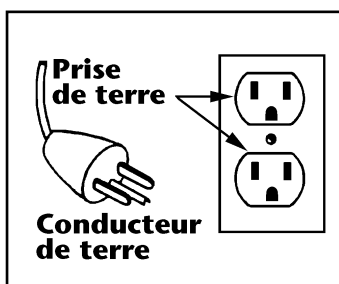

Cet appareil est destiné à un circuit de 120V et est muni d'une fiche de mise à la terre semblable à celle illustrée par le croquis A de la figure "A". S'assurer que l'appareil est branché à

une prise de courant ayant la même configuration que la fiche. Aucun adaptateur ne devrait être utilisé avec cet appareil.

### AVERTISSEMENT

Un conducteur de terre mal raccordé peut entraîner un risque de choc électrique. Consulter un électricien ou un technicien d'entretien qualifié si vous n'êtes pas certain que la

prise soit correctement mise à la terre. Ne pas modifier la fiche fournie avec l'appareil si elle ne peut être insérée dans la prise, faire installer une prise adéquate par un électricien qualifié.

## VACUUM ASSEMBLY

### 3 & 4 Caster Vacuums

These vacuums require some assembly.

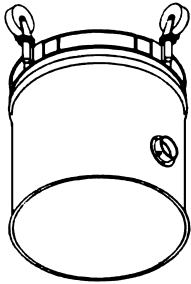

1) Carefully remove and set aside the motor head and filter assembly.

2) Turn the canister upside down. Insert casters into caster mount assemblies and press down to lock in position.

### Glidemobile w/Handle Vacuums

The vacuum's handle is in the storage position when shipped and must be moved to the operating position.

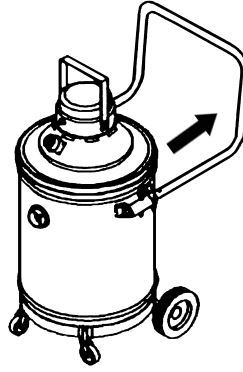

1) Firmly grasp the speed pins on each side of the handle and pull up and out.

2) Pull handle slowly away from tank and align front handle holes in handle bracket.

3) Insert speed pins through holes on both sides, locking handle in position.

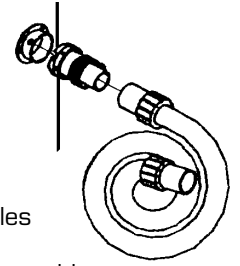

### Hose & Swivel Connector

The hose and swivel connector are pre-assembled at the factory and attaches to the canister intake.

1) Line up the swivel connector slots with the retaining rivets on the intake.

2) Insert swivel connector and twist clockwise until rivets rest against slot ends.

## FILTER INSTALLATION, REMOVAL AND MAINTENANCE

The Sootmaster vacuums are designed for dry pickup. The 660M and 661M can be converted to a wet vacuum providing you use the optional wet pickup adaptor (305987).

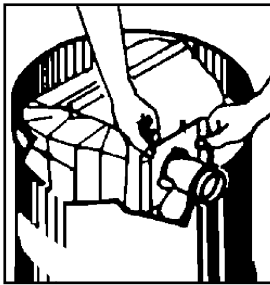

### To Install Paper Filter Bag & Cloth Filter:

1) Remove the motor head and set aside. Empty filters, hose and other attachments that may be packed in the tank.

2) Expand filter bag pleats, then grasp scored ends of cardboard and pull forward completely onto inlet tube as close to tank wall as possible.

3) Position the cloth filter assembly on top of the tank, replace motor head on tank and close the clamps.

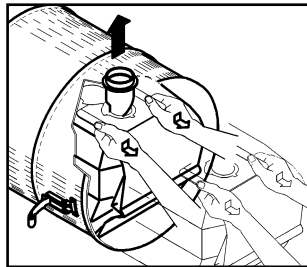

### To Remove Loaded Filter Bag:

1) Remove motor head and cloth filter assembly and set aside. Lay cleaner on its side with inlet tube on top.

2) Pull bag out of tank, using care not to puncture bag with inlet tube.

3) Reseal cardboard flap that covered filter bag opening.

Install a fresh **NEW** paper filter bag.

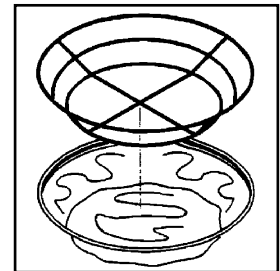

### Cloth Filter Maintenance:

In order to maintain maximum efficiency of the vacuum cleaner it is important to clean the cloth filter each time the tank is emptied. To clean the cloth filter, shake off loose particles and brush exposed surface with a soft bristle brush.

**NOTE: DO NOT WASH**, shrinkage to the cloth and damage to the gasket can occur.



### CAUTION

**Exercise caution when handling the motor head.  
Dropping the motor head may cause permanent damage to internal components.**

## 654M/655M/ (16") 1 HP Air-Thru Motor Head

## MOTOR HEAD

## REPLACEMENT PARTS LIST

| Ref No | Part Description          | Qty | Part No |
|--------|---------------------------|-----|---------|
| 1      | Complete Head Assembly    | 1   | 341444  |
| 2      | Push-In Cap Plug          | 1   | 312509  |
| 3      | Switch Assembly           | 1   | 306940  |
| 4      | #10-24 X 3/4" Screw       | 1   | 337315  |
| 5      | Strain Relief             | 1   | 318329  |
| 6      | 30 Ft, 18/3 Line Cord     | 1   | 318647  |
| 7      | 16" Cover Assembly        | 1   | 320617  |
| 8      | Gasket                    | 1   | 365394  |
| 9      | Orange Wire Connector     | 1   | 398985  |
| 10     | Insulation Tube           | 1   | 363685  |
| 11     | Yellow Wire Connector     | 2   | 350648  |
| 12     | Small Purse Lock          | 1   | 365491  |
| 13     | Large Purse Lock          | 1   | 365483  |
| 14     | Motor Guard               | 1   | 422398  |
| 15     | 1 HP Air-Thru Motor       | 1   | 350699  |
| 16     | Ground Lead w/Terminals   | 1   | 307440  |
| 17     | #12 Int Tooth Lockwasher  | 3   | 364037  |
| 18     | #10-32 X .31 Ground Screw | 1   | 393258  |
| 19     | Screw Protector           | 6   | 341649  |
| 20     | #10-32 X 5/8" Screw       | 4   | 310913  |
| 21     | #12 X 1/2" Screw          | 6   | 314595  |

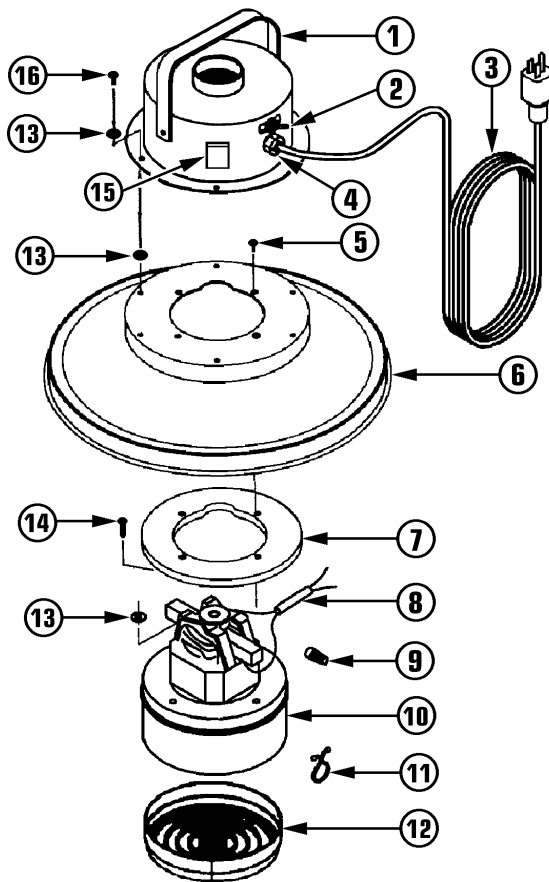
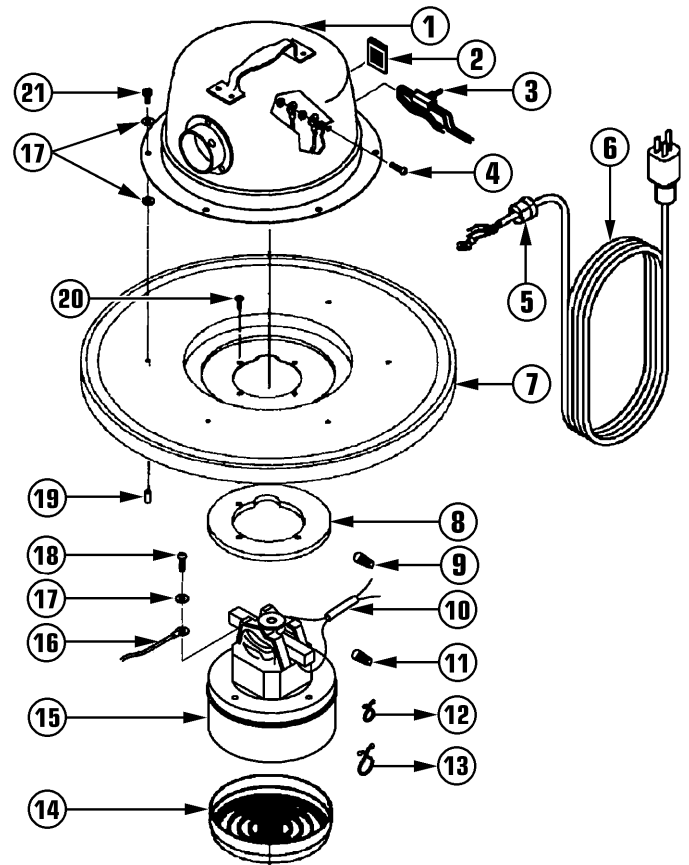

## 641M/652M/653M - 14" 1 HP Motor Head

| Ref No | Part Description         | Qty | Part No |
|--------|--------------------------|-----|---------|
|        | Complete Head Assembly   | 1   | 341037  |
| 1      | Dome Assembly            | 1   | 310832  |
| 2      | Switch Assembly          | 1   | 306940  |
| 3      | 30 Ft, 18/3 Line Cord    | 1   | 318647  |
| 4      | Strain Relief            | 1   | 318329  |
| 5      | #10-32 X 5/8" Screw      | 4   | 310913  |
| 6      | 14" Cover                | 1   | 310565  |
| 7      | Circle Gasket            | 1   | 365394  |
| 8      | Insulation Tube          | 1   | 363685  |
| 9      | Orange Wire Connector    | 3   | 398985  |
| 10     | 1 HP, Air-Thru Motor     | 1   | 350699  |
| 11     | Purse Lock               | 1   | 365483  |
| 12     | Motor Guard              | 1   | 422398  |
| 13     | #12 Int Tooth Lockwasher | 3   | 364037  |
| 14     | #10-32 X 5/16" Screw     | 1   | 393258  |
| 15     | Cap Plug                 | 1   | 312509  |
| 16     | #10 X 1/2" Screw         | 6   | 310824  |

# MOTOR HEAD

## REPLACEMENT PARTS LIST

### 660M/661M (16" Dia) 16" - 2<sup>1</sup>/<sub>4</sub> HP Motor Head

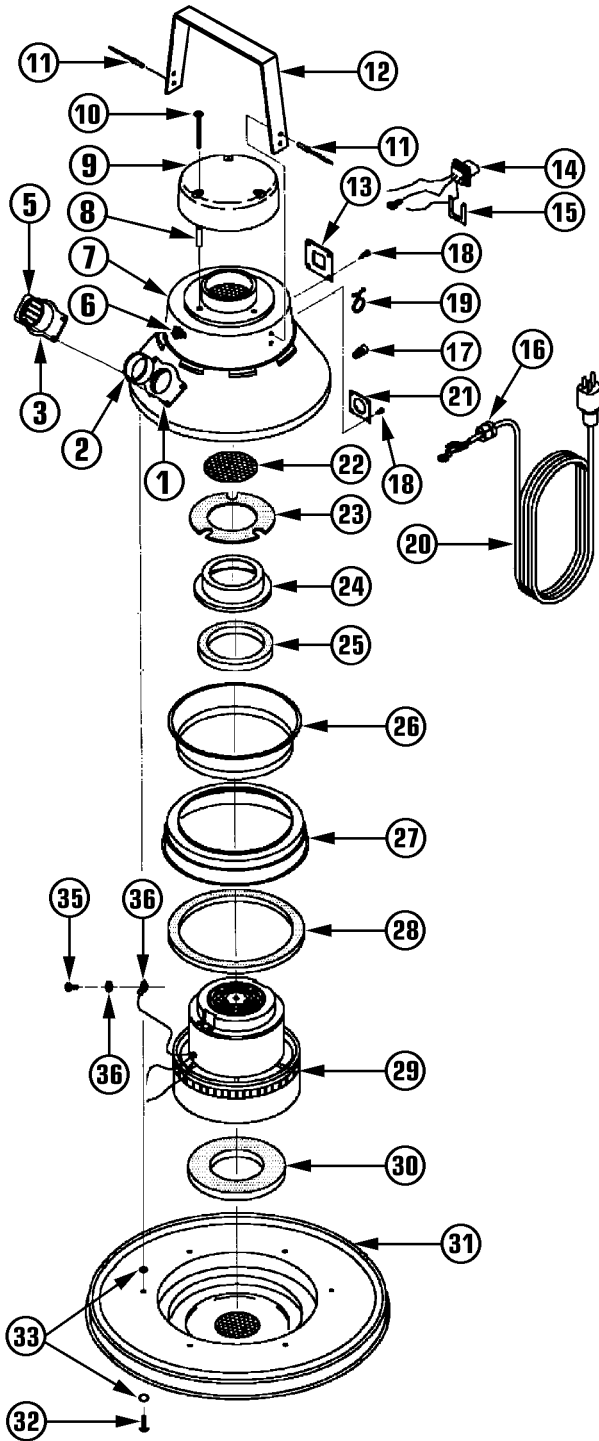

| Ref No | Part Description                               | Qty | Part No |
|--------|--|-----|---------|
|        | Complete Head Assembly                         | 1   | 369896  |
| 1      | Exhaust Connector Gasket                       | 1   | 364606  |
| 2      | Flat Gasket                                    | 1   | 368008  |
| 3      | Air Deflector Exhaust                          | 1   | 367958  |
| 5A     | Exhaust Assembly                               | 1   | 346764  |
| 5B     | Exhaust Connector w/Pins                       | 1   | 364665  |
| 6      | Switch   | 1   | 324140  |
| 7A     | Dome Assembly                                  | 1   | 369551  |
| 7B     | Dome   | 1   | 367818  |
| 8      | Steel Spacer                                   | 3   | 367842  |
| 9      | Dome Cover                                     | 1   | 367850  |
| 10     | #10-24 X 1 <sup>3</sup> / <sub>4</sub> " Screw | 3   | 366676  |
| 11     | Handle Pop Rivets                              | 4   | 318906  |
| 12     | Carrying Handle                                | 1   | 367834  |
| 13     | Receptacle Mounting Plate                      | 1   | 367990  |
| 14     | Convenience Outlet                             | 1   | 341746  |
| 15     | Retainer Clips                                 | 1   | 341932  |
| 16     | Strain Relief                                  | 1   | 318329  |
| 17     | Yellow Wire Connector                          | 4   | 350648  |
| 18     | #6-32 X 1 <sup>1</sup> / <sub>4</sub> " Screw  | 8   | 349402  |
| 19     | Large Purse Lock                               | 2   | 365483  |
| 20     | 30 Ft, 14/3 Line Cord                          | 1   | 312789  |
| 21     | Strain Relief Mounting Plate                   | 1   | 367982  |
| 22     | Disc Screen                                    | 1   | 367893  |
| 23     | Pyrell Gasket                                  | 1   | 367885  |
| 24     | Air Conductor Spinning                         | 1   | 367974  |
| 25     | Top Motor Gasket                               | 1   | 317446  |
| 26     | Motor Holddown Spinning                        | 1   | 367915  |
| 27     | Air Collector Assembly                         | 1   | 367931  |
| 28     | Flat Gasket                                    | 1   | 379158  |
| 29     | 2 <sup>1</sup> / <sub>4</sub> HP By-Pass Motor | 1   | 304301  |
| 30     | Motor Gasket                                   | 1   | 378607  |
| 31     | 16" Cover Assembly                             | 1   | 373206  |
| 32     | #10-24 X 1 <sup>1</sup> / <sub>2</sub> " Screw | 6   | 372633  |
| 33     | #12 Internal Tooth Lockwasher                  | 2   | 364037  |
| 34     | Electrical Terminal                            | 1   | 319724  |
| 35     | #10-24 X 3 <sup>3</sup> / <sub>4</sub> " Screw | 1   | 337315  |
| 36     | #10-24 Hex Nut w/Lockwasher                    | 3   | 331201  |

**641M / 652M / 653M (14" Dia)  
654M / 660M (16" Dia) Tanks w/Casters**

| Ref No | Part Description                        | Qty | Part No |
|--------|---|-----|---------|
| 1A     | 641M 14" Tank w/Hardware                | 1   | 341010  |
| 1B     | 652M 14" Tank w/Hardware                | 1   | 341045  |
| 1C     | 653M 14" Tank w/Hardware                | 1   | 341053  |
| 1C     | 654M/660M 16" Tank w/Hardware           | 1   | 341436  |
| 2      | Inlet Fitting                           | 1   | 325406  |
| 3      | 1 1/2" Hose Connector                   | 1   | 349445  |
| 4      | 2 1/2" Swivel Casters (641M 3 Casters)  | 4   | 307408  |
| 5A     | 3-Socket 14" Wire Dolly (641M)          | 1   | 374881  |
| 5B     | 4-Socket 14" Wire Dolly (652M / 653M)   | 1   | 374903  |
| 5C     | 4-Socket 16" Wire Dolly (654M / 660M)   | 1   | 374911  |
| 6      | #12-14 X 1" Screw                       | 1   | 335169  |
| 7      | #10-12 Hex Nut                          | 1   | 311243  |
| 8      | Holdown Clamps                          | 3   | 358312  |
| 9      | Lift Handles (Except 641M / 652M)       | 2   | 374261  |
| 10A    | Disposable Filter Bags (641M-5/Pk)      | 1   | 356212  |
| 10B    | Disposable Filter Bags (652M/653M-5/Pk) | 1   | 356891  |
| 10C    | Disposable Filter Bags (654M/660M-5/Pk) | 1   | 333115  |
| 11A    | 14" Pancake Filter Assembly             | 1   | 306428  |
| 11B    | 16" Deep Dish Filter Assembly           | 1   | 306444  |
| 12A    | 14" Cloth Filter w/Gasket               | 1   | 306452  |
| 12B    | 16" Cloth Filter w/Gasket               | 1   | 306479  |
| 13A    | 14" Filter Frame                        | 1   | 304158  |
| 13B    | 16" Filter Frame                        | 1   | 304107  |

**VACUUM TANK  
REPLACEMENT PARTS LIST**

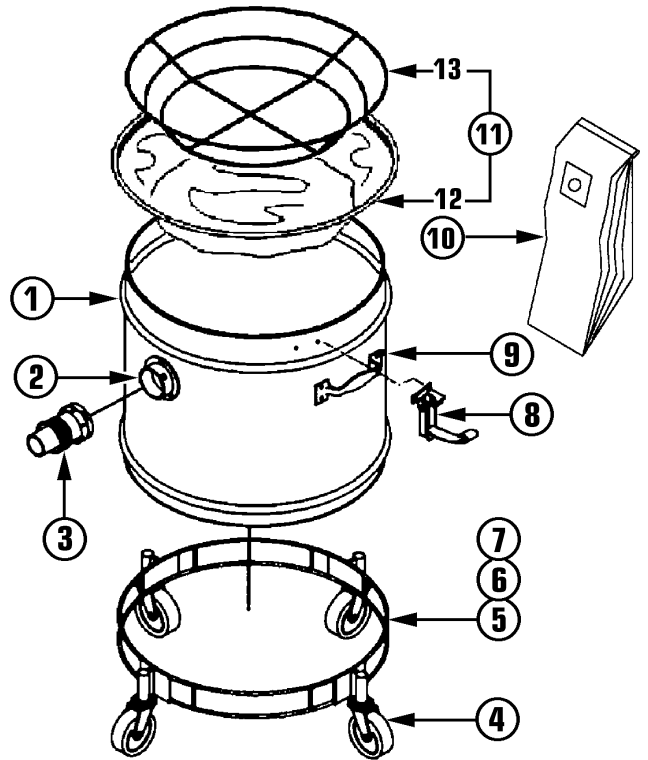

**655M / 661M (16" Dia)  
Tank w/Glidemobile**

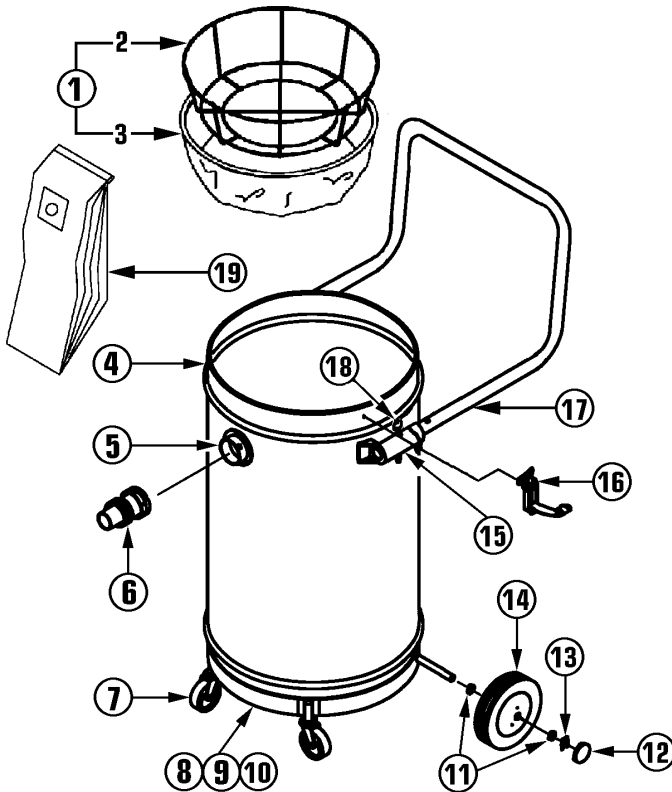

| Ref No | Part Description              | Qty | Part No |
|--------|-------------------------------|-----|---------|
| 1      | 16" Deep Dish Filter Assembly | 1   | 306444  |
| 2      | 16" Filter Frame              | 1   | 304107  |
| 3      | 16" Cloth Filter W/Gasket     | 1   | 306479  |
| 4      | Tank Assembly                 | 1   | 326232  |
| 5      | Inlet Fitting                 | 1   | 325406  |
| 6      | 1 1/2" Hose Connector         | 1   | 349445  |
| 7      | 2 1/2" Swivel Caster          | 4   | 307408  |
| 8      | Glidemobile Dolly             | 1   | 319783  |
| 9      | 1/4 - 20 Hex Nut              | 1   | 338966  |
| 10     | 1/4 - 20 X 1 1/2" Bolt        | 1   | 345555  |
| 11     | Steel Washer                  | 4   | 315435  |
| 12     | Chrome Hub Cap                | 2   | 319317  |
| 13     | 1/2" X 1" Palnut              | 2   | 319619  |
| 14     | 8" Wheels                     | 2   | 319309  |
| 15     | Handle Brackets               | 2   | 376949  |
| 16     | Holdown Clamps                | 3   | 358312  |
| 17     | Push Handle                   | 1   | 376906  |
| 18     | Speed Pin Assembly            | 2   | 385182  |
| 19     | Disposable Filter Bags (5/Pk) | 1   | 333115  |

# TOOLS, ACCESSORIES AND OPTIONAL FILTERS

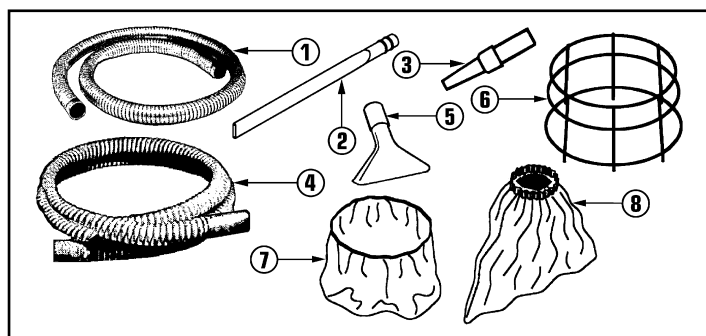

| Ref No                  | Description                    | Part No |
|-------------------------|--------------------------------|---------|
| 1                       | 6 Ft Flexible Metal Hose       | 304409  |
| 2                       | 27" Crevice Tool               | 304352  |
| 3                       | Blower Nozzle                  | 304425  |
| 4                       | 10 Ft Rubber Lined Canvas Hose | 344923  |
| 5                       | Upholstery Tool                | 386413  |
| 6                       | 14" Hose Cage (For 14" Tanks)  | 313408  |
| <b>Optional Filters</b> |                                |         |
| 7A                      | 14"-2 Ply Intermediate Filter  | 347515  |
| 7B                      | 16"-2 Ply Intermediate Filter  | 363375  |
| 8A                      | 14" Dacron Filter Bag          | 300861  |
| 8B                      | 16" Dacron Filter Bag          | 300888  |

## Optional Filters

The use of the Intermediate or Dacron Bag Filter gives added protection to the motor head and life to the cloth filter.

### Dacron Filter Bag

- 1) Install a disposable paper filter bag on to the vacuum inlet fitting.
- 2) Install the Dacron Filter Bag in around the outside of the cloth filter assembly so the elastic top sits on the filter's gasket.
- 3) Position the filter assembly on top of the tank, replace the motor head on tank and close the clamps.

### 2 Ply Intermediate Filter

- 1) Install a disposable paper filter bag on to the vacuum inlet fitting.
- 2) Place the 2 Ply Intermediate Filter in position on top of tank,
- 3) Folding the filter over the outside of tank. Overlap it approximately one inch.

- 4) Place the cloth filter assembly on the the tank, being carefully not to move 2 ply filter. The filter's gasket must sit evenly on the tank rim so that an air tight seal will be obtained.
- 5) Replace motor head assembly on top of the filter assembly, and resnap holdown clamps.

# TROUBLE SHOOTING GUIDE



**Mastercraft**

Address:

777 South Street, P. O. Box 2310  
Newburgh NY 12500-0606

Tel:

(800) 835-7812 • (845) 565-8850

Fax:

(800) 752-6883 • (845) 565-9392

E-Mail

sootmaster@mastercraftusa.com

## PROBLEM: Loss of Vacuum.

### CAUSE:

- 1) Full paper filter bag.
- 2) Dry filter clogged or gasket worn
- 3) Clogged hose or wand.
- 4) Canister rim dented.
- 5) Loose or broken fan.
- 6) Motor not working.

### SOLUTION:

- 1) Replace paper filter bag.
- 2) Clean cloth filter or replace gasket.
- 3) Remove obstruction.
- 4) Replace canister.
- 5) Contact manufacturer or service center.
- 6) Contact manufacturer or service center.

## PROBLEM: Motor is not running.

### CAUSE:

- 1) Faulty ON/OFF switch.
- 2) Power cord defective.
- 3) Loose connection or wiring.
- 4) Motor defective.
- 5) Blown fuse or tripped circuit breaker.

### SOLUTION:

- 1) Contact manufacturer or service center.
- 2) Contact manufacturer or service center.
- 3) Contact manufacturer or service center.
- 4) Contact manufacturer or service center.
- 5) Replace fuse or reset circuit breaker.

## PROBLEM: Dust blowing from vacuum when running.

### CAUSE:

- 1) Paper filter bag full or torn.
- 2) Paper filter bag not installed properly.

### SOLUTION:

- 1) Replace filter bag.
- 2) Reinstall or replace paper filter bag properly or off inlet tube.