

MASTERCRAFT 1505D Owner's Manual

[Shop genuine replacement parts for MASTERCRAFT
1505D](#)

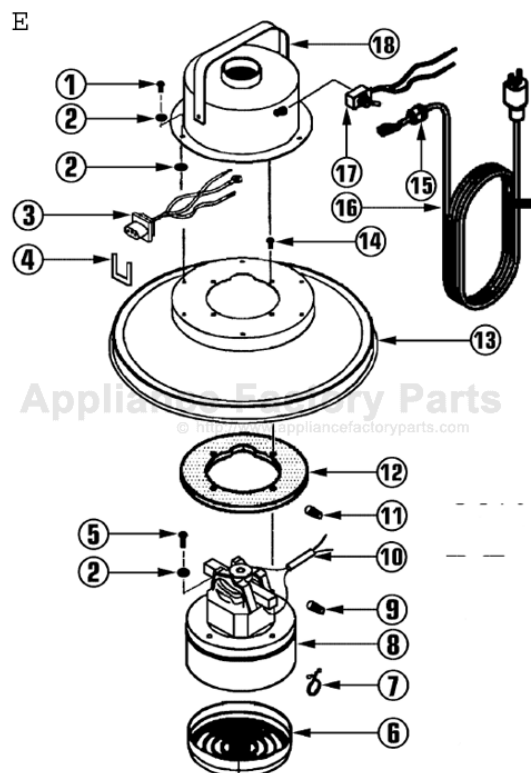

[Find Your MASTERCRAFT Vacuum Cleaner Parts - Select From 99 Models](#)

----- Manual continues below -----

SAFETY, OPERATION & MAINTENANCE MANUAL



POLY & STEEL DRY & WET/DRY VACUUM CLEANERS

This unit is intended for commercial use.

**READ AND FOLLOW ALL INSTRUCTIONS,
WARNINGS & CAUTIONS
BEFORE USING THIS VACUUM/BLOWER**



This vacuum cleaner will afford you many years of trouble-free operating satisfaction, provided it is given proper care. All parts have passed rigid quality control standards prior to being assembled to produce the finished product. Prior to packaging, the vacuum was again inspected for assurance of flawless assembly.

Your vacuum is protectively packed to prevent damage in shipment. We recommend that upon delivery, unpack the vacuum and inspect it for any possible dam-

age. Only a visual examination will reveal damage that may have occurred.

If damage is discovered, immediately notify the transportation company that delivered your vacuum. As a shipper, we are unable to report claims for concealed damage. You must originate any claims within 5 days.

This manual is for your protection and information. **PLEASE READ CAREFULLY** since failure to follow precautions could result in discomfort or injury.

**READ ALL
INSTRUCTIONS
BEFORE
OPERATING**

SAVE THESE INSTRUCTIONS

IMPORTANT SAFETY INSTRUCTIONS

WARNING:



To Reduce the Risk of Fire, Electric Shock or Injury:

Dry Vacuums

Electric shock could occur if used on wet surfaces.

DO NOT expose to rain - Store Indoors

Wet Vacuums

To avoid electric shock **DO NOT** expose to rain. Store Indoors
Electric shock could occur if power nozzle is used on wet surfaces.

When using this electric vacuum, basic precautions should always be followed, including the following:

- 1] **DO NOT** leave the vacuum when plugged in. Unplug it from the outlet when not in use and before servicing.
- 2] This is **NOT** a toy. Close attention is necessary when used around or near children.
- 3] Use only as described in this safety manual. Use only the manufacturer's recommended attachments and accessories.
- 4] **DO NOT** use this vacuum with damaged cord or plug. If the vacuum is not working as it should, because it has been dropped, damaged, left outdoors or dropped into water, contact an authorized service center or factory.
- 5] **DO NOT** pull the vacuum by the cord, use cord as a handle, close a door on the cord or pull cord around sharp edges and corners. **DO NOT** run vacuum over the cord. Keep the cord away from heated surfaces.
- 6] **DO NOT** unplug the vacuum by pulling on the cord. To unplug, grasp the plug, not the cord.
- 7] **DO NOT** handle the vacuum plug or vacuum with wet hands.
- 8] **DO NOT** put any objects into openings. **DO NOT** use with any openings blocked; keep free of dust, lint, hair, and anything that may reduce air flow.
- 9] Keep hair, loose clothing, fingers, and all parts of body away from openings and moving parts.
- 10] **DO NOT** pick up anything that is smoking or burning such as cigarettes, matches, or hot ashes.
- 11] **DO NOT** use without dust bag and/or filters in place for dry operation and wet adaptor for wet operation.
- 12] Turn **OFF** all the controls before unplugging.
- 13] Use extra care when cleaning on stairs.
- 14] **DO NOT** use this vacuum to pick up flammable or combustible liquids such as gasoline or use in areas where they may be present.
- 15] **DO NOT** use where anesthetics or oxygen are used.
- 16] Replace damaged or worn parts immediately with genuine original equipment parts to maintain safety and to protect your limited warranty.
- 17] **DO NOT** use an extension cord unless absolutely necessary. If an extension cord is used, then wire size must be #14 gauge or larger and should not exceed 50 feet in length. The extension cord must be three-wire type to insure **GROUNDING** protection.

This vacuum must be connected to a properly grounded outlet only. See grounding instructions (Page 3). If your vacuum has an outlet for a motorized power nozzle, always turn the vacuum **OFF** before connecting or disconnecting the motorized nozzle.

SAVE THESE INSTRUCTIONS

DANGER



GROUNDING INSTRUCTIONS

Improper use of the grounding plug can result in a risk of electric shock.

Electrical equipment must be grounded. If it should malfunction or breakdown, grounding provides a path of least resistance for electrical current to reduce the risk of electric shock. This vacuum is equipped with a cord having an equipment-grounding conductor and grounding plug. The plug must be inserted into an appropriate outlet that is properly installed and

grounded in accordance with all local codes and ordinances.

If repair or replacement of the cord or plug is necessary, **DO NOT** connect the grounded wire to either flat blade terminal. The wire with insulation having an outer surface that is green with or without yellow stripes is the grounding wire.

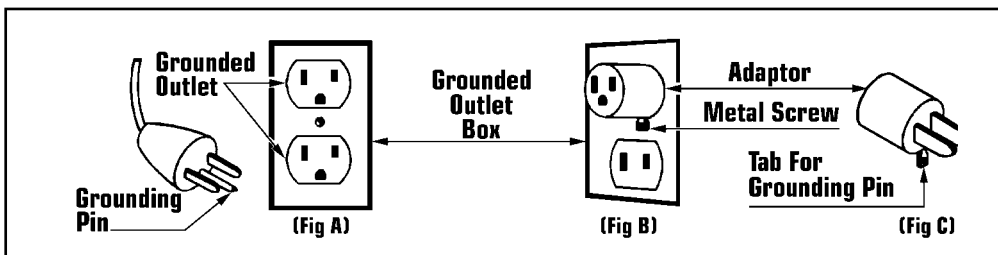

GROUNDING METHODS

This electric equipment is for use on a nominal 120 volt circuit, and has a grounded plug that looks like the plug illustrated in (Fig A). A temporary adaptor that looks like the adaptor illustrated in (Fig B & C) may be used to connect this plug to a 2-pole receptacle as shown in (Fig B) if a properly grounded outlet is not available.

The temporary adaptor should be used only until a properly grounded outlet (Fig A) can be installed by a qualified electrician. The green color rigid ear, lug or the like extending from the adaptor must be connected to a permanent ground such as a properly grounded outlet box cover. Whenever the adaptor is used, it must be held in place by a metal screw (Fig C).

WARNING:



Improper connection of the equipment-grounding conductor can result in a risk of electric shock. Check with a qualified electrician or service person if you are in doubt as to whether the outlet is properly grounded. **DO NOT** modify the plug provided with the equipment. If it will not fit the outlet, have a proper outlet installed by a qualified electrician.

Note: In Canada, the use of a temporary adaptor is not permitted by the Canadian Electrical Code.

Treat this vacuum as you would any other high grade precision made product. Dropping, unreasonable bumping across thresholds and other misuses may result in a damaged unit which will not be covered by warranty.

When not in use, the power cord should be wrapped around the motor head for storage.

Read this manual completely before operating this vacuum. It is important to follow instructions in this manual to prevent the possibility of injury or damage to the user and/or vacuum.

CARE OF THIS VACUUM

LIRE TOUTES LES INSTRUCTIONS AVANT DE FAIRE FONCTIONNER (CET APPAREIL)

1] Ne pas laisser l'appareil sans surveillance lorsqu'il est branché. Débrancher lorsque l'appareil n'est pas utilisé et avant l'entretien.

2] Ne pas permettre aux enfants de jouer avec l'appareil. Une attention particulière est nécessaire lorsque l'appareil est utilisé par des enfants ou à proximité de ces derniers.

3] N'utiliser que conformément à cette notice avec les accessoires recommandés par le fabricant.

4] Ne pas utiliser si le cordon ou la fiche est endommagé. Retourner l'appareil à un atelier de réparation s'il ne fonctionne pas bien, s'il est tombé ou s'il a été endommagé, oublié à l'extérieur ou immergé.

5] Ne pas débrancher en tirant sur le cordon. Tirer plutôt la fiche.

6] Ne pas toucher la fiche ou l'appareil lorsque vos mains sont humides.

INSTRUCTIONS VISANT LA MISE À LA TERRE

Cet appareil doit être mis à la terre. En cas de défaillance ou de panne éventuelles, la mise à la terre fournit au courant un chemin de moindre résistance qui réduit le risque de choc électrique. Cet appareil est pourvu d'un cor-

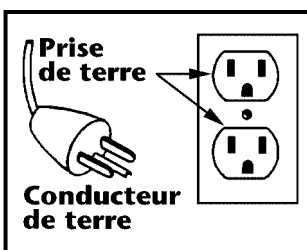

Un conducteur de terre mal raccordé peut entraîner un risque de choc électrique. Consulter un électricien ou un technicien d'entretien qualifié si vous n'êtes pas certain que la prise soit cor-

rectement mise à la terre. Ne pas modifier la fiche fournie avec l'appareil-si elle ne peut être insérée dans la prise, faire installer une prise adéquate par un électricien qualifié.

AVERTISSEMENT



Pour réduire les risques d'incendie, de choc électrique ou de blessure:

POUR APPAREIL SEC

Pour réduire les risques de choc électrique, ne pas aspirer de matières humides, ne pas exposer à la pluie et garder l'aspirateur à l'intérieur.

POUR APPAREIL HUMIDE

Pour réduire les risques de choc électrique, ne pas exposer à la pluie et garder l'aspirateur à l'intérieur.

L'utilisation d'un appareil électrique demande certaines précautions:

11] Ne pas utiliser l'appareil si le sac à poussière ou le filtre n'est pas en place.

12] Mettre toutes les commandes à la position ARRET avant de débrancher l'appareil.

13] User de prudence lors du nettoyage des escaliers.

14] Ne pas aspirer des liquides inflammables ou combustibles, comme de l'essence, et ne pas faire fonctionner dans des endroits où peuvent se trouver de tels liquides.

15] Toujours mettre l'interrupteur de l'appareil à la position ARRET avant de brancher ou de débrancher la brosse à moteur.

16] Ne brancher qu'à une prise de courant avec mise à la terre. Voir les instructions visant la mise à la terre.

AVERTISSEMENT

rectement mise à la terre. Ne pas modifier la fiche fournie avec l'appareil-si elle ne peut être insérée dans la prise, faire installer une prise adéquate par un électricien qualifié.

CONSERVER CES INSTRUCTIONS

VACUUM TANK ASSEMBLY

4-Caster Tanks

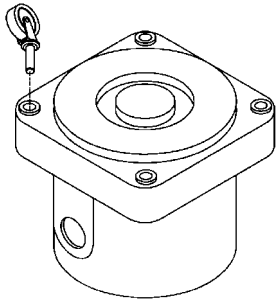

This vacuum requires some assembly.

1] Carefully remove and set aside motor head and filter assembly

2] Turn tank upside down.

Poly Tanks: Press caster into plastic socket until bottom of stem fits flush against plastic socket.

Steel Tanks: Insert casters into caster mount assemblies.

Glidemobile Tank w/Handle

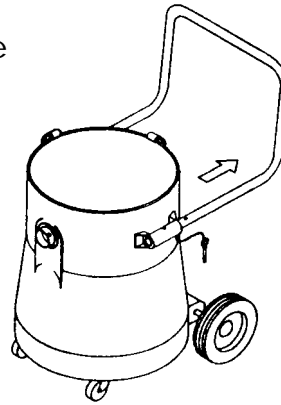

This vacuum is shipped with the handle in the storage position and must be moved to the operating position

1] Firmly grasp speed pin on each side of handle and pull up and out.

2] Pulling handle slowly away from the tank, align front handle holes with holes in handle bracket.

3] Insert speed pins through holes on both sides, locking handle in position. Attach tool caddy. (Not included with all models).

HOSE, WAND & TOOL ASSEMBLY

Hose & Swivel Connector

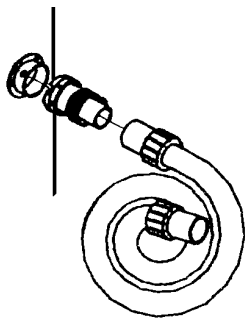

The hose and swivel connector are pre-assembled at the factory. To attach the swivel connector to intake fitting on vacuum tank:

1] Line up swivel connector slots with retaining rivets on the intake.

2] Insert swivel connector and twist clockwise until rivets reset against slot end.

1 1/4" Tool Kit Assembly

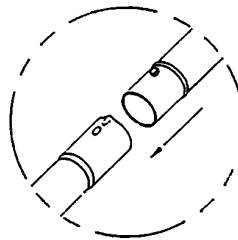

Wand Assembly: Both sections are exactly the same. Slide the tapered end of one section into the slotted end of the other wand section.

Attach Hose: Slide curved elbow on hose into wand end with slots on the side.

Install Tool: Insert tool into the tapered end of the wand.

1 1/2" Tool Kit Assembly

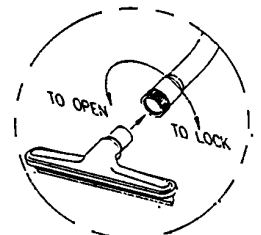

Wand Assembly: Align button lock of upper wand section with the opening for button lock in the lower wand section and push sections together.

Attach Hose: Slide free end of hose into the grooved end of upper wand.

Install Tool: Turn wand nut counter-clockwise approximately (4) complete turns. Insert the tool into wand nut and coupling. While holding tool in place, turn nut clockwise until wand nut is fully locked.



CAUTION:

Exercise caution when handling the motor head.
Dropping the motor head may cause permanent damage to internal components.

DRY OPERATION

WARNING:



Electric shock could occur if used on wet surfaces
DO NOT expose to rain - Store Indoors.

Dry (only) vacuums are equipped with an air-thru motor are designed for dry pick-up only.

Wet/dry vacuums are equipped with a bypass motor can be used for dry and wet pick-up. When ordered to be used as a dry vacuum, the unit is shipped with a dry filter only.

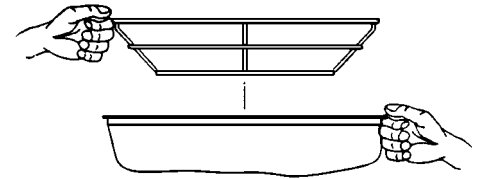

Dry Filter Installation

1] Remove the motor head and set aside. Empty filters, hose and other attachments that may be packed in the tank.

2] Install a disposable paper filter bag as illustrated on the bag, attach cloth filter to wire filter frame, set filter assembly on tank, replace motor head and snap down holddown clamps.

Dry Filter Maintenance

In order to maintain maximum vacuum cleaner efficiency it is important to clean the cloth filter each time the tank is emptied. To clean the cloth filter, shake off loose particles and brush exposed surface with a soft bristle brush.

NOTE: DO NOT WASH, shrinkage to the cloth and damage to the gasket can occur.

WET/DRY OPERATION

WARNING:

To avoid electric shock DO NOT expose to rain. Store Indoors.
Electric shock could occur if power nozzle is used on wet surfaces.

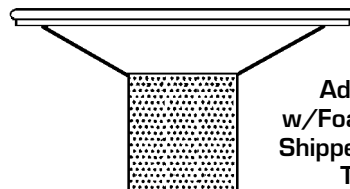

Adaptor
w/Foam Filter
Shipped w/Poly
Tank
Vacuums

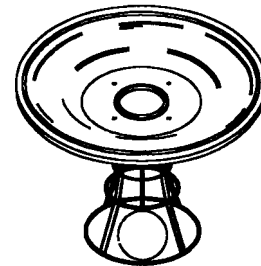

Adaptor w/Wire
Cage Shipped
w/Steel Tank
Vacuums

When ordered as a wet/dry vacuum, this unit is shipped with a dry filter for dry pick-up and wet adaptor for liquid recovery. Follow instructions on page 5 for dry operation

Wet Pick-Up Adaptor Installation

The safety float located in the protective frame of the wet adaptor stops the vacuum action of motor head when maximum recovery of liquid is reached.

1] Disengage the three (3) clamps that hold the motor head to the tank and carefully set aside.

2] Remove the dry filter assembly and disposable paper filter bag.

3] Set the wet adaptor on the tank, replace the motor head and snap down the holddown clamps.

Note: The wet pickup adaptor on some motor head are permanently mounted and are not removed for dry pickup.

Paper Bag & Cloth Filters Installation

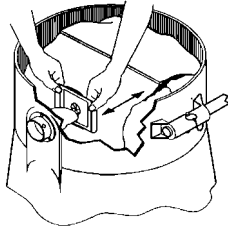

1] Expand paper filter bag pleats, then grasp scored ends of cardboard and pull forward completely onto inlet tube as close to tank wall as possible.

2] Position cloth filter assembly on the tank, then place motor head on tank and close clamps.

Loaded Filter Bag Removal

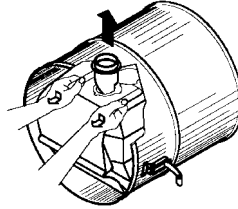

1] Remove motor head and cloth filter assembly and lay cleaner on its side with inlet tube on top.

2] Remove filter bag from inlet and pull bag out of tank, using care not to puncture bag with inlet tube.

3] Reseal cardboard flap that covered filter bag opening. Install a new paper filter bag.

FILTER INSTALLATION & REMOVAL

The foam filter on the wet adaptor for the poly tanks **MUST** be washed after each use or the vacuum's performance will be greatly reduced, and also checked for clogging, wear and tear. If the filter is clogged with dirt, lint, etc., it won't work.

To Clean Foam Filter:

1] Remove the motor head assembly from the tank.

2] Slide foam sleeve down off the plastic float cage.

3] Wash out the foam sleeve with water and a mild detergent, rinse out with clean water until the water is clear.

4] After cleaning the foam filter, check it for signs of wear and tear. Replace if there are holes in the foam material large than a normal pore size. Reorder part no 365300 from your distributor.

To Install Foam Filter:

1] Gently pull the foam filter up and over the plastic float cage until it covers all the cage openings.

CARE OF WET ADAPTOR W/FOAM FILTER

REMOVAL OF LIQUIDS FROM VACUUM TANKS

Important

DO NOT store the vacuum with any liquids inside the tank. Before storing or converting over for dry pickup run the emptied vacuum for approximately 5 minutes to eliminate moisture in the tank hose and tools.

Tanks without Drain Valves

1] Disengage clamp from tank, remove motor head and wet pickup adaptor. Carefully set aside.

2] Pour liquid from tank into suitable drain.

Steel Tanks w/Drain Valves

1] Center the drain valve over a drain in the floor.

2] Open drain valve by turning the valve counterclockwise and continue turning until the desired flow is reached.

3] After the tank is drained, and before closing the drain valve make sure that there are no obstructions that will prevent the valve from sealing. Turn valve clockwise until it is fully closed and sealed.

Poly Tanks w/ Gate Valves

1] Center the tank's gate valve over a floor drain.

2] Pull up on the gate valve handle to empty the tank.

TROUBLE SHOOTING GUIDE



Address:
777 South Street
P.O. Box 2310
Newburgh, N Y 12550-0606

TEL:
(800) 835-7812
(845) 565-8850

FAX:
(800) 752-6883
(845) 565-9392

URL:
www.mastercraftusa.com

E-mail:
mail@mastercraftusa.com

CAUTION:



Always disconnect power cord before servicing vacuum.

PROBLEM: Loss of Vacuum.

CAUSE:

- 1] Full disposable paper filter bag.
- 2] Dry filter assembly clogged.
- 3] Clogged hose or wand.
- 4] Tank rim damaged.
- 5] Loose or broken fan.

- 6] Motor not working.
- 7] Float not functioning.
- 8] Gasket worn.

SOLUTION:

- 1] Replace disposable paper filter bag.
- 2] Clean cloth filter.
- 3] Remove obstruction.
- 4] Replace tank.
- 5] Contact manufacturer or authorized service center.
- 6] Contact manufacturer or authorized service center.
- 7] Check to see if ball on rod moves freely or tank is full.
- 8] Replace gasket.

PROBLEM: Motor is not running.

CAUSE:

- 1] Broken switch.
- 2] Power cord defective.
- 3] Motor defective.
- 4] Blown fuse or tripped circuit breaker.

SOLUTION:

- 1] Contact manufacturer or authorized service center.
- 2] Contact manufacturer or authorized service center.
- 3] Contact manufacturer or authorized service center.
- 4] Replace fuse or reset circuit breaker.

PROBLEM: Dust blowing from vacuum when running.

CAUSE:

- 1] Full disposable paper filter bag.
- 2] Disposable paper filter bag not installed properly or off inlet tube.
- 3] Cloth filter bag dirty.
- 4] Cloth or paper filter bag is torn.
- 5] Paper filter bag is not installed.

SOLUTION:

- 1] Replace disposable paper filter bag.
- 2] Reinstall properly or replace disposable paper filter bag.
- 3] Clean cloth filter bag.
- 4] Replace.
- 5] Install paper filter bag.

PROBLEM: Water blowing from vacuum when running.

CAUSE:

- 1] Tank is full of liquid.
- 2] Sudsy or foamy liquid is being picked up.

SOLUTION:

- 1] Empty tank.
- 2] Add defoamer to tank.

WARNING:



Repairs should only be performed by an authorized service center.