

This Owner's Manual is provided and hosted by [Appliance Factory Parts](#).



ADAMS KAS200 Owner's Manual

[Shop genuine replacement parts for ADAMS KAS200](#)



[Find Your ADAMS HVAC Parts - Select From 98 Models](#)

----- Manual continues below -----

Uni-Pak™



**The unique
unit heater from
ADAMS**

Uni-Pak delivers the heat.

Because warm air rises, a lot of expensive heat is hovering around the ceiling instead of warming the floor below. But a Uni-Pak unit heater captures that hot air and directs it anywhere — across or down — to make any space more comfortable.



Sturdy cabinet has protective baked enamel finish.

All units are AGA design certified.

Front or bottom air discharge with individual adjustable louvers can be changed in field to suit application.

Hangers attached to the unit permit easy installation.



Top mounted fan increases overall efficiency of unit by pulling warm air from ceiling.

Fan motor assembly is mounted to unit using rubber isolators. Ensures quiet performance.

Fan motor is permanently lubricated and has thermal overload protection.

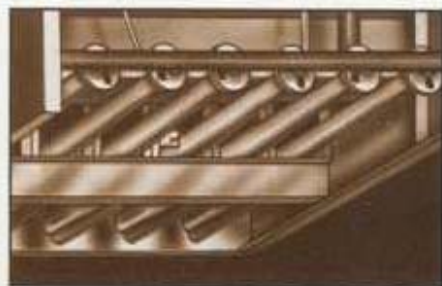

Patented non-linting burners for natural or propane gas. Self-locking for exact alignment with heat exchanger; easily removed.

Controls and manifold are totally enclosed for improved protection.

Service and maintenance for burners, pilot and controls is convenient from bottom and rear of unit.



Fan switch is time on and time off.

Safety limit switch is included with each unit.

Automatic, redundant gas valve on all models. Standing pilot models have 100% safety shutoff.



Sectionalized heat exchanger is die formed and electric welded. Designed to be free from expansion and contraction noise.

exactly where you want it.

The unique Uni-Pak unit heater features attractive styling over plenty of power. Available in standing pilot or electric-pilot from 65,000 to 200,000 BTU input.

The permanently lubricated fan motor has thermal overload protection, and features a time on / time off fan switch. (200,000 BTU model has two fan motors.)

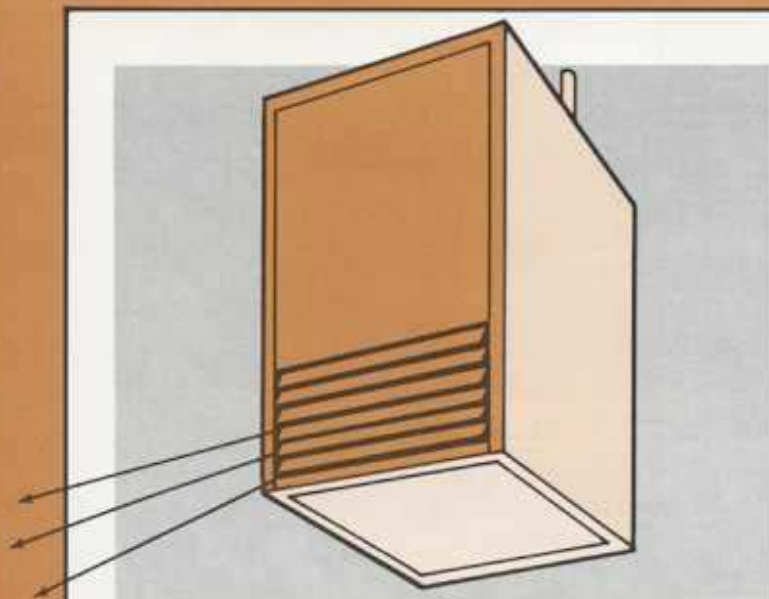

The Uni-Pak unit heater's interchangeable louvers and panels permit air to be discharged horizontally or downward to meet area heating requirements. Panels can be field changed easily as needed.

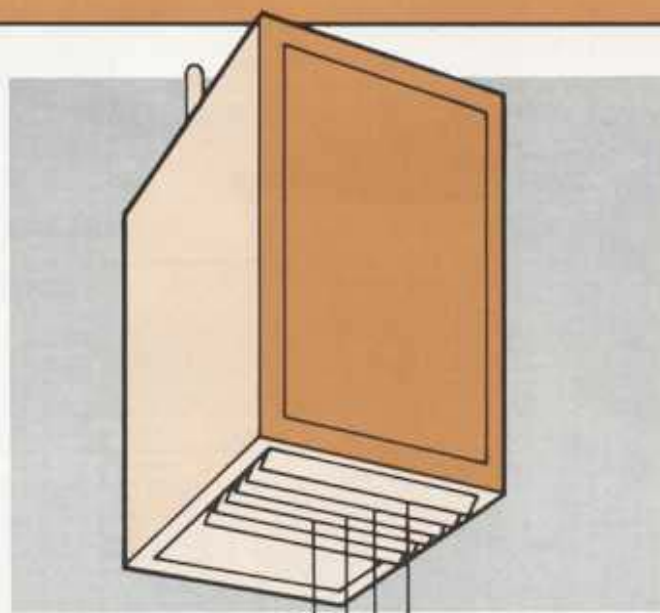

Achieve even better heat specifying two, three or on the work area to be distribution by four units, depending heated.

Versatile

Uni-Pak patented design burners work equally well on either natural or propane gas and may be easily removed for cleaning when necessary. For further versatility, Uni-Pak can be used with either a 24 volt or 110 volt thermostat without any changes or additions to the basic unit.

Durable

Aluminized steel heat exchanger resists corrosion. Uni-Pak heat exchangers are over 30% heavier than some other manufacturer's and are backed by a 10 year warranty.

Quiet

The fan motor assembly is cushioned in rubber to ensure quiet performance. Sectionalized heat exchanger is die formed and electric welded, designed to be free of expansion and contraction noise.

Safe

Every Uni-Pak unit is fire tested to ensure proper ignition; the electrical control circuit and components are thoroughly checked; and the heat exchanger is tested for leaks prior to assembly in the furnace. A safety limit switch is included with each unit.

Unit should be installed a minimum of 7 ft. above floor.



Design Certified for
Natural Gas or LPG

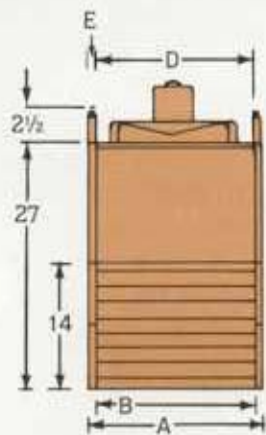

KAS 65-80-100-130-160

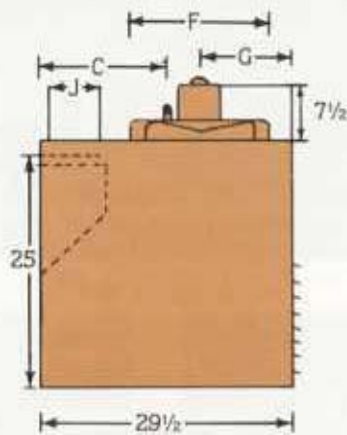

ALL KAS

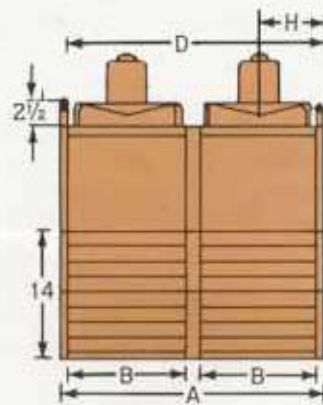

KAS 200

DIMENSIONS

MODEL	CABINET WIDTH A	LOUVER WIDTH B	HANGER SPACING			FAN DIMENSIONS			FLUE DIA. J	PIPE SIZE		APPROX. SHIP. WT.
			DEPTH C	WIDTH D	CENTER E	DIA. F	CENTER G	CENTER H		PROPANE	NAT.	
KAS65	14	10 1/2	14 9/16	13 3/8	3/16	12 1/2	15 1/16	7	4	1/2	1/2	110
KAS80	17	13 1/2	15 9/16	15 1/4	7/8	14 1/2	11 1/16	8 1/2	5	1/2	1/2	130
KAS100	20	16 1/2	15 9/16	18 1/4	7/8	16 1/2	12 15/16	10	5	1/2	1/2	150
KAS130	26	22 1/2	15 9/16	24 1/4	7/8	20 1/2	10 13/16	13	6	1/2	1/2	190
KAS160	32	28 1/2	15 9/16	30 1/4	7/8	20 1/2	10 19/16	16	7	1/2	3/4	230
KAS200	38	15 1/2	15 9/16	36 1/4	7/8	16 1/2	12 15/16	10	7	3/4	3/4	290

NOTE: Cabinet height does not include motor projection.

SPECIFICATIONS

MODEL NUMBER		A.G.A. INPUT	A.G.A. OUTPUT	FAN DIA.	H.P.	MOTOR TYPE	R.P.M.	C.F.M.	THROW FT.
STANDING PILOT	ELECTRIC IGNITION								
KAS65	EKAS65	65,000	49,400	12	1/12	S. P.	1050	800	55
KAS80	EKAS80	80,000	60,000	14	1/12	S. P.	1050	970	60
KAS100	EKAS100	100,000	75,000	16	1/12	S. P.	1050	1200	65
KAS130	EKAS130	130,000	97,000	20	1/8	S. P.	1050	1600	75
KAS160	EKAS160	160,000	121,000	20	1/3	S. P.	1050	2000	85
KAS200	EKAS200	200,000	150,000	2-16	2-1/12	S. P.	1050	2400	95

CAUTION — KAS unit heaters are not intended for residential use.

Hangers — 3/16 rod for KAS65.

1/2 in. threaded pipes for all other models.

OIL FIRED MODELS AVAILABLE.

CLEARANCE TO COMBUSTIBLE MATERIALS

Area	Front Discharge	Bottom Discharge
SIDES	6"	6"
CASING TOP	12"	12"
BOTTOM	6"	8"
FRONT	8"	6"

NOTE: EKAS models available for natural gas use only.

ADAMS Uni-Pak™

9790 Midwest Ave. • Cleveland, Ohio 44125-2497
(216) 587-6801