

This Owner's Manual is provided and hosted by [Appliance Factory Parts](#).



ADAMS HP-225 Owner's Manual

[Shop genuine replacement parts for ADAMS HP-225](#)



[Find Your ADAMS HVAC Parts - Select From 98 Models](#)

----- Manual continues below -----

ADAMS

SPEEDFLAME

POWER GAS BURNERS

Certified for Natural & LP Gases

Installation, Operation, Maintenance Manual

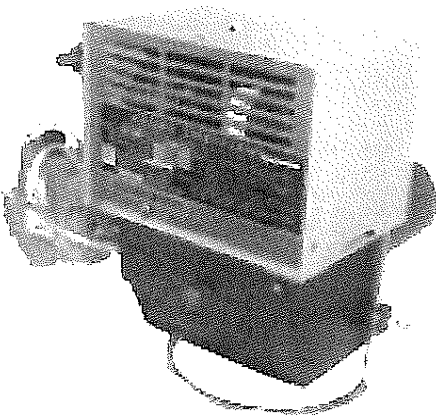

HP Series

WARNING !

If the information in these instructions are not followed exactly a fire or explosion may result, causing property damage, personal injury or death.
Code compliance is the sole responsibility of the installer.

If You Smell Gas!

- Do not try to light any appliance.
- Do not touch any electrical switch.
- Do not use any phone in your building.
- Immediately call your gas supplier from a neighbor's phone.
- If you cannot reach your gas supplier call the fire department.

CAUTION !

Do not store gasoline flammable liquids or vapors in the vicinity of this or any other fuel burning appliance.

Installation and service must be performed by a qualified installer, service agency or the gas supplier



Installer: Affix this manual adjacent to the burner!

Inform and demonstrate the correct operation and maintenance of the burner.

GENERAL INFORMATION

The Models HP-(225,400)B(PS) conversion burners are adjustable to most heating appliances that have a suitable combustion chamber. Do not use in sectional type heating appliances or on revertible (diving) flue design applications.

This design series of gas conversion burners are certified by the Canadian Standards Association to the ANS Z21.17/CSA 2.7-1998 Gas Conversion Burner Standards.

The installation must conform to local codes, with the Standard for the Installation of Domestic Gas Conversion Burners, ANSI Z21.8, the National Fuel Gas Code, ANSI Z223.1, or the CAN/CGA-B149, Installation Codes.

If an external electrical source is utilized, the conversion burner, when installed must be electrically grounded in accordance with local codes or, in the absence of local codes, with the National Electrical Code, ANSI/NFPA 70, or the Canadian Electrical Code, C22.1.

These publications are available from the Canadian Standards Association or from the National Fireprotection Association.



⚠ WARNING
CARBON MONOXIDE
POISONING HAZARD

CARBON MONOXIDE IS A COLORLESS, ODORLESS GAS THAT CAN KILL. FOLLOW THESE RULES TO CONTROL CARBON MONOXIDE.

- ▲ Do not use this burner in an unvented, enclosed area. Carbon monoxide may accumulate.
- ▲ Do not adjust the pressure regulator. High pressures produce carbon monoxide.
- ▲ Check flue gases for carbon monoxide. This check requires specialized equipment.
- ▲ Allow only qualified burner service persons to adjust the burner. Special instruments and training are required.



⚠ WARNING
OVERHEATING HAZARD

SHOULD OVERHEATING OCCUR:

- (1) Shut off the manual gas control to the appliance.
- (2) Do not shut off the control switch to the pump or blower.

SPECIFICATIONS HP - SERIES

MODEL	HP-225	HP-400
Max. Input BTU/Hr.	225,000	400,000
Min. Input BTU/Hr.	50,000	100,000
Burner Tube Dia.	4" (10.2cm)	4" (10.2cm)
Inlet Pressure: Nat. LPG	5.5" - 10.5" W.C. 1.37 - 2.61 kPa 11.0" - 14" W.C. 2.74 - 3.48 kPa	5.5" - 10.5" W.C. 1.37 - 2.61 kPa 11.0" - 14" W.C. 2.74 - 3.48 kPa
Manifold Pressure: Nat. LPG	3.5" W.C. ; 0.87 kPa 10.0" W.C. ; 2.50 kPa	3.5" W.C. ; 0.87 kPa 10.0" W.C. ; 2.50 kPa
Voltage	120V 60 Hz	120V 60 Hz
Ignition System	Standing Pilot or Electronic	Standing Pilot or Electronic

STANDARD EQUIPMENT

- Precision balanced centrifugal blower.
- Cast iron combustion head.
- Low voltage automatic gas valve.
- Low voltage motor relay and transformer.
- Adjustable pedestal.
- EPI - 2 (Nat.) or EPI - 100 - 2 (LPG) ignition model.

COMBUSTION AIR AND VENTILATION

Successful operation of any fuel burning heating systems depends on a continuous and adequate supply of air for both combustion and draft divider dilution. Open basements and below grade utility rooms or crawl spaces without storm windows or tight doors will generally permit adequate air infiltration.

If the heating system is located in a separate room with a tight door, ventilation must be provided to an open area within the building or to the outside. If the openings are within the building two open grills must be installed, one near the floor and one close to the ceiling. The open (non-adjustable) grills must have a free area of at least one square inch (6.45sq. cm) per 1,000 BTU of burner input. The area of each grill shall not be less than 100 square inches (645 sq. cm).

If the building is of unusually tight construction or has a large exhaust fan installed, on a basement, crawl space or slab home, provisions must be made for outside air supply that is ducted into the furnace room. It must have a permanent (non-adjustable) opening of at least one square inch (6.45 sq. cm) of free area per 1,000 BTU input. The area of each grill shall not be less than 100 square inches (645 sq. cm). Consult the National Fuel Gas Code latest edition, or the CAN/CGA-B149 Installation Codes for more detailed information.

With either standing pilot or electronic ignition systems the burner performs well under slight or momentary back draft conditions. However, it is not intended for operation under sustained reverse draft conditions. This condition is fairly common in buildings with large ventilation fans. The fans can create a sub-atmospheric pressure in the building causing a down draft in the chimney. This will cause hazardous flue gas products to be drawn into the building from the draft diverter. The conditions must be corrected promptly.

PREPARATION OF THE HEATING APPLIANCE

During the preparation and installation of the burner be sure to provide adequate clearances for servicing the burner and an unobstructed flow of combustion air for proper operation.

- The heating appliance must be in good repair and have adequate capacity to heat the structure.
- Keep materials, combustible or otherwise, at least two feet (.61m) from the heating appliance.
- Thoroughly clean the heat exchanger and inspect for cracks or other defects - the installer must determine if the appliance is safe to upgrade.
- The combustion chamber must be free from deterioration and adequately sized.
- Domestic hot water coils in fire pots should be removed or disconnected. If disconnected, the ends must be left opened.
- Remove all soot, scale and ash inside the furnace or boiler, particularly in the flue passages. If any cracks cannot be repaired, the part should be replaced.
- Stainless steel chambers must be lined with ceramic fiber material to prevent deterioration.
- All ceramics used for the gas combustion chambers should be capable of withstanding temperatures of at least 2,300°F (1261°C) in order to prevent disintegration.

COAL FIRED UNITS (See Figure 1)

To convert an appliance that was coal fired, the following consideration needs to be observed:

- Select feed door or ash-pit door for burner mounting.

- **Ash-pit:** Remove grates, shaker base, ash pit door and install combustion chamber.
- **Feed Door:** Fill bottom with suitable material (vermiculite, etc.). Fasten or cement feed door slide in the closed position. File latch on the feed door so that it can be opened with reasonable pull without being lifted.

WARM AIR FURNACES

- Ceramic or fire bricks inside the fire box should be inspected. Look for leaks in the fire pot and radiator.
- Remove part of the outer casing at two or three points. Insert an electric lamp inside the fire box and observe. Light will disclose any loose joints, cracks or holes.
- Under no circumstances should refractories be installed in an attempt to repair a cracked fire pot. Bad cracked or broken castings should be replaced.
- Seal all joints and cracks with boiler putty or furnace cement. Do not use asbestos.
- If combustion chamber upgrade is necessary, do not reduce the original height of outlet configuration.

BOILERS, CAST IRON & STEEL, STEAM OR HOT WATER

- Inspect for water leaks and repair any that are found.
- Inspect refractory liner and/or fire brick combustion chambers. Replace if not in good condition. **NOTE - Do not** remove the chamber from a dry base boiler.
- Clean the gauge glass on steam boilers so that all safety devices and controls are operating to the manufacturer's specifications.
- Make sure safety valve is in good operating condition.

OIL - FIRED FURNACES & BOILERS (See Figure 1)

- Inspect refractory liner. Repair or replace if damaged. The combustion chamber must be left in the dry leg of boilers.
- Where there is space between the combustion chamber, it will be necessary to provide a tube between the two so that the combustion air must go into the combustion chamber.

INSTALLING VENT (FLUE) PIPE AND DRAFT DIVERTER/DOUBLE ACTING BAROMETRIC DAMPER

Select the proper size of galvanized vent pipe from Table I. Any reduction of the vent pipe size must be made at the furnace vent outlet by means of a fixed collar reducer. Flue pipe should be 24 gauge or heavier steel.

NOTE: If the vent pipe is more than 10 feet (3.04m) long or contains more than two elbows, use next larger vent pipe and draft diverter

NOTE: Where local codes permit, install a double acting barometric damper, rather than a draft diverter. Less heated air is lost up the chimney with a barometric damper than with a draft diverter.

WARNING: SPILL SWITCH

A device which will automatically shut off gas to the burner in the event of sustained backdraft is required. It shall be of the listed manual reset type and installed and adjusted by a qualified service technician in accordance with the manufacturer's instructions.

For revertible or diving type furnace (down draft type), use one size larger vent pipe and draft diverter.

Figure 1

1" = 2.54cm

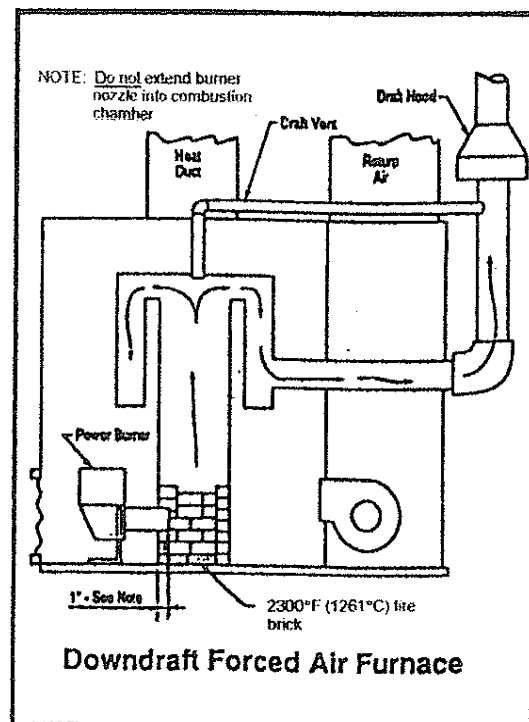
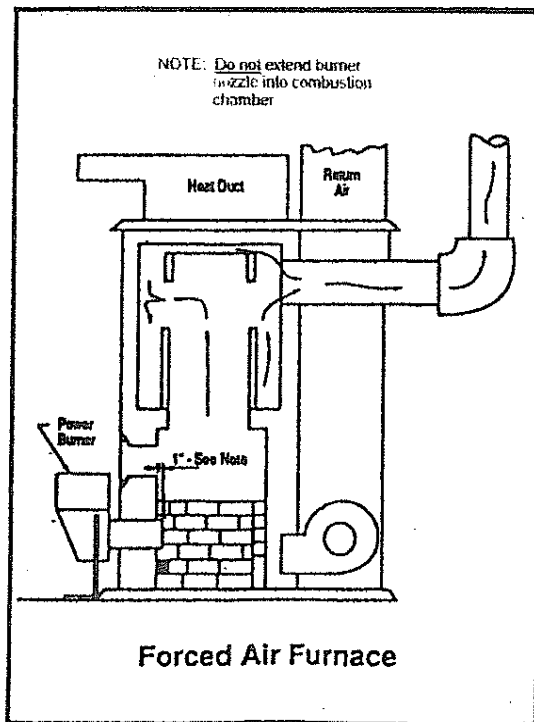
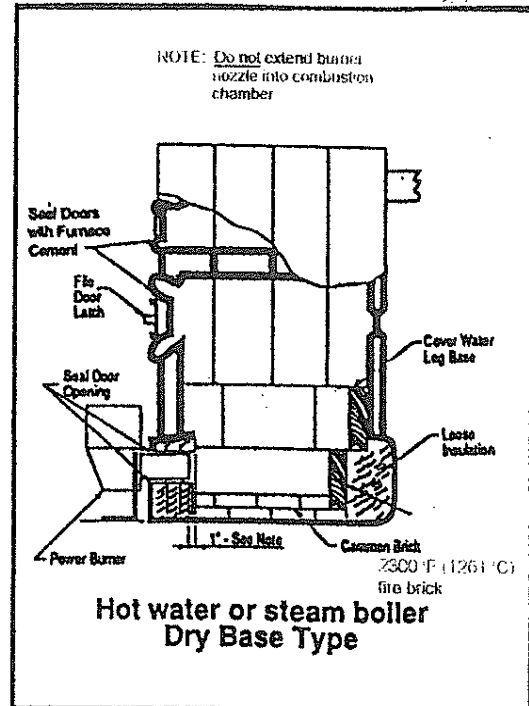
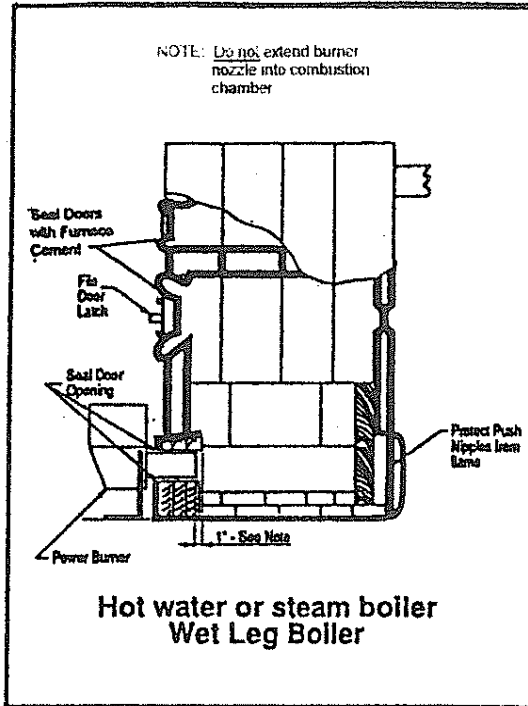

TABLE I

6,500 BTU per square inch (cm) of flue area is the maximum allowed.	
BURNER INPUT BTU/HR	DRAFT DIVERTER AND/OR VENT SIZE
Up to 120,000	5 Inch (12.7cm)
120,000 -160,000	6 Inch (15.2cm)
160,000 - 250,000	7 Inch (17.8cm)
250,000 - 325,000	8 Inch (20.3cm)
325,000 - 400,000	9 Inch (23.0cm)

Flue pipe should be spaced at least 6 inches (15.2cm) from any combustibles. If flue pipe passes through a combustible partition, a ventilated thimble should be used. Consult the local codes in your area. Flue pipe should be firmly cemented into the chimney but must not extend past inner wall surface. All vent pipe should slope upward toward the chimney at least 1/4 inch (.64cm) per foot of length.

The draft diverter must be CSA certified. Draft diverters should be galvanized and the size should correspond to that of the vent pipe. Horizontal diverters should be placed as close to the outlet of the furnace or boiler as possible.

On reverted type furnaces or boilers the diverter should be above the highest flue passage.

Vertical draft diverters should have two pipe diameters between the skirt and any surface under it. This spacing can be reduced to one diameter for horizontal or horizontal to vertical diverters.

Reverted flue furnaces sometimes have a knockout between the combustion chamber and the heat exchanger. This should be removed when converting to gas. If the reversion creates an unvented pocket an opening should be cut and a pipe run directly to the flue pipe ahead of the draft diverter. This vent line should be at least 1 inch (2.54cm) pipe and connected between the furnace. The relief pipe must be gas tight.

After the diverter and flue pipe are in place, secure all sections together with self-tapping metal screws. Any draft or check doors or other openings in the vent pipe or chimney should be sealed shut.

CHIMNEYS

A chimney of adequate draft and in good condition is essential to the proper operation of your heating plant. If the chimney does not meet the following standards, we suggest that the necessary changes be made.

Each central heating plant should have its own flue without any other vent pipe or vent pipe connections to the same chimney. The suggestions outlined in detail 4 of figure 2 should be followed.

All joints of the chimney must be tightly cemented. The inside of the chimney should be free of all obstructions, such as, loose bricks and broken pieces of tile.

Be sure there are no openings in the partition separating flues. All cleanout doors must fit tightly.

A thimble (detail 3) should be used to connect the chimney so that the vent pipe is readily removable.

Where the chimney is inadequate, a chimney liner should be installed in accordance with local codes and regulations.

The internal construction of the chimney should be corrosion resistant tile, stainless steel or some other material that will withstand flue gas products. If the chimney is unlined, consult the local gas company for their recommendations.

Many prefabricated chimneys on either slab construction or basement homes, terminate near the ceiling level. During rainstorms it is common for water to run down the heating appliance flue pipe. Many warm air heating appliances have a flue outlet directly above the burner. There is always a possibility that the water from the flue pipe will drain out upon the burner and its controls. This condition must be corrected by installing a cap or rain shield on top of the chimney. See Figure 3 for common Chimney troubles and their corrections.

INSTALLING ELECTRICAL WIRING

All wiring should conform to the National electrical Code ANSI/NFPA 70 or, the Canadian Electrical Code CSA C22.2, or the legally authorized code in your area. Use multiple conductor wiring not lighter than 14 gauge for line voltage. The conversion burner must be grounded.

If an external electrical source is utilized, the conversion burner, when installed, must be electrically grounded in accordance with local codes or, in the absence of local codes, with the National electrical Code, ANSI/NFPA, or the Canadian Electrical Code, CSA C22.1.

Failure to exercise extreme care in the wiring may result in damaged controls and failure of the burner to operate.

Each burner contains its own 20VA, 24 volt transformer. Under no circumstances should any other equipment be run off of that transformer. Electrical damage to the conversion burner may result.

CAUTION: Label all wires prior to disconnection when servicing controls. Wiring errors can cause improper and dangerous operation.

Verify proper operation after servicing.

A Spill Switch device will automatically shut off gas to the burner in the event of sustained backdraft is required. It shall be of the listed manual reset type and installed and adjusted by a qualified service technician in accordance with the

manufacturer's instructions.

See Figure 4 for wiring diagrams.

FIGURE 4 - WIRING DIAGRAMS

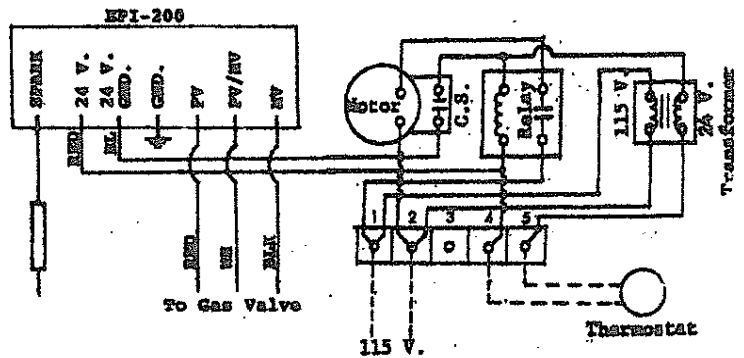
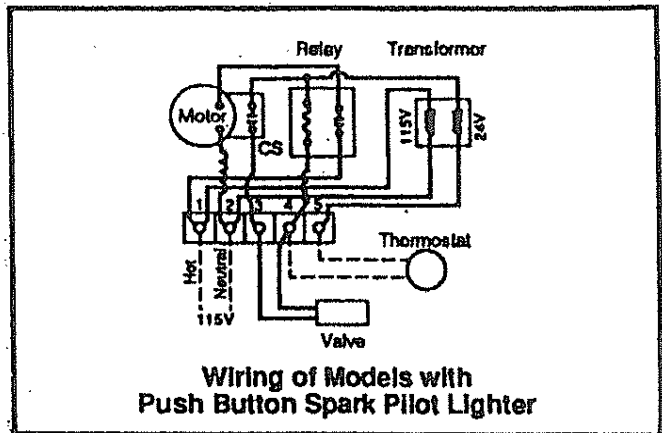

If any of the original wires as supplied with the conversion burner must be replaced, it must be replaced with type 105°C wire or its equivalent.

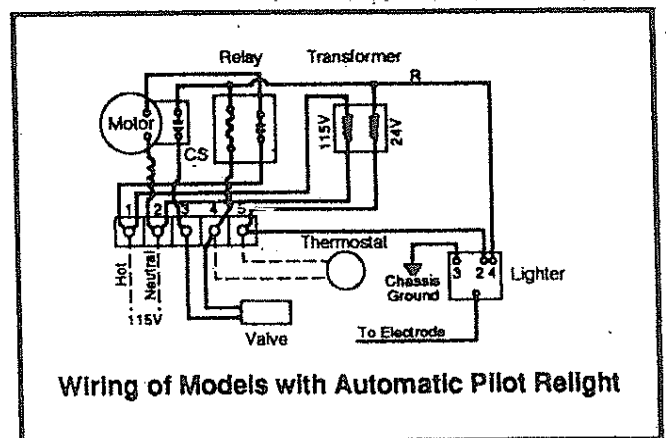

**FIGURE 2
CHIMNEYS**

24" = .61m
12" = .30m

1) The chimney height will be determined by surrounding roof and trees. Chimney should extend at least 24-in. above high point of roof with no obstructions from nearby roofs, trees.

AREA OF FLUE IN CHIMNEY MUST AT LEAST EQUAL THE LARGEST FLUE PLUS 50% OF THE AREA OF THE ADDITIONAL FLUES.

4) If chimney is used for a tank heater, in addition to boiler or furnace, smoke pipe from tank heater must connect into chimney above smoke pipe from boiler or furnace.

2) Trim or remove any nearby trees that would interfere with the chimney draft.

5) In cases where flue extends to basement floor, draft can usually be improved by filling base of chimney with sand to within 12 inches of smoke pipe and relocating cleanout door.

3) Vent pipe should extend only to (and not beyond) inside wall of chimney. Cement vent pipe tightly into chimney opening.

6) Gas-fired units will require less draft than coal-fired, however, a chimney flue of adequate draft and capacity is required. An CSA draft diverter must be installed on all gas-fired heating units.

**FIGURE 3
COMMON CHIMNEY TROUBLES AND THEIR CORRECTIONS**

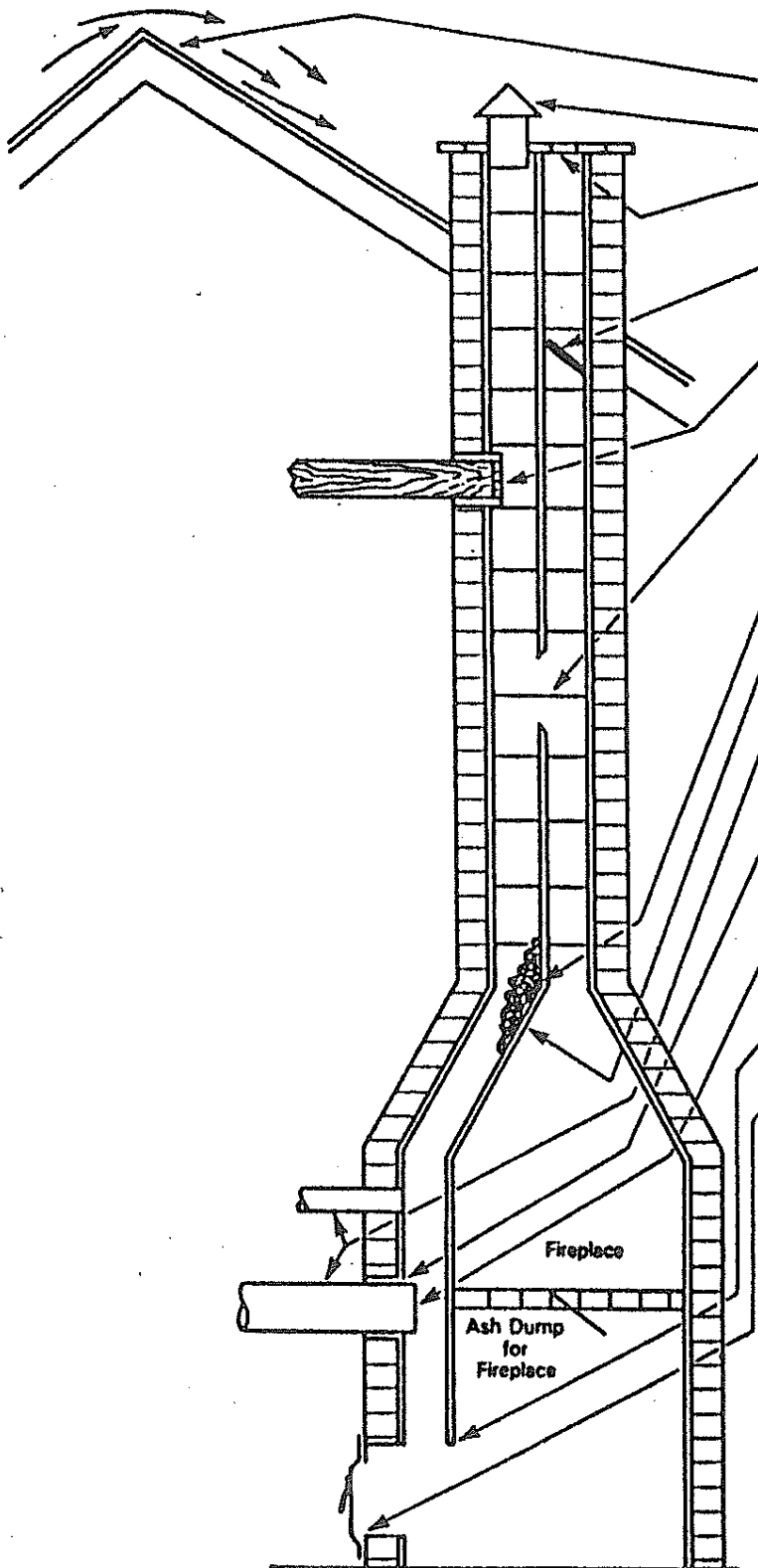

Troubles	Examination	Corrections
Top of chimney lower than surrounding objects.	Observation.	Extend chimney above all objects within 30 feet.
Chimney cap or ventlator.	Observation.	Remove.
Coping restricts opening.	Observation.	Make opening as large as inside of chimney.
Obstruction in chimney.	Can be found by light and mirror reflecting conditions in chimney.	Use weight to break and dislodge.
Joint projecting into chimney.	Lowering a light on extension cord.	Must be handled by a competent brick contractor.
Break in chimney lining	Smoke test/build smudge fire blocking off other opening, watching for smoke to escape.	Must be handled by a competent brick contractor.
Collection of soot at narrow space in flue opening.	Lower light on extension cord.	Clean out with weighted brush or bag of loose gravel on end of fire.
Offset.	Lower light on extension.	Change to straight or to long offset.
Two or more openings into same chimney.	Found by inspection from basement.	The least important opening must be closed, using same other chimney flue.
Loose seated pipe in flue opening.	Smoke test.	Leaks should be eliminated by cementing all pipe openings.
Smoke pipe extends into chimney.	Measurement of pipe from within or observation of pipe by means of a lowered light.	Length of pipe must be reduced to allow end of pipe to be flush with inside of flue.
Failure to extend the length of flue partition down to the floor.	By inspection or smoke test.	Extend partition to floor level.
Loose-fitted clean-out door.	Smoke test.	Close all leaks with cement.
Severe down draft condition.	By draft meter test.	Install a Bridort type roof cap.

30' = 9.1m

ROOM THERMOSTAT: Regulates operation of burner to maintain set temperature.

Locate the thermostat where it will sense the natural air circulation within the building usually on an inside wall of a room at a height of five (5) ft. (1.5m) above the floor. Place it where, at all times, it will reflect the average room temperature.

It is not recommended that a thermostat be installed on an outside wall, in front of a fireplace or at the base of an open stairwell.

When the current draw cannot be determined accurately by the above method, measure the current with an ampere meter using the 1 AMP scale. Connect the meter leads in series with one of the thermostat leads for the accurate reading. By adding the primary control current to the gas valve current, the result is the anticipator setting. (Example: $.2 + .6 = .8$ amps)

LIMIT CONTROL

Limits temperature that may develop in a warm air furnace or hot water boiler and limits pressure in a steam boiler.

Locate limit control where it will quickly be affected by temperature or pressure of the furnace or boiler.

1.) WARM AIR

Located on furnace plenum.

2.) HOT WATER

For gravity forced circulation; locate on vertical flow pipe directly above boiler if the control is a surface or clamp type.

Immersion types should be on top or upper part of front boiler section.

3.) STEAM

Located at top of boiler.

Recommendations of the control manufacturer should be followed. Also, the heating plant should be checked out to be sure all of the controls are operating properly.

INSTALLING GAS PIPING

It is recommended that a separate line be run from the meter to the burner in accordance with table 2.

TABLE 2

Burner Firing Rate in BTUH	IRON PIPE SIZES FOR NATURAL				
	Feet (m) of Pipe from Meter to Burner				
	10 (3)	20 (6)	30 (9)	40 (12)	50 (15)
50,000	1/2" (.01)	1/2" (.01)	3/4" (.02)	3/4" (.02)	3/4" (.02)
100,000	3/4" (.02)	3/4" (.02)	3/4" (.02)	3/4" (.02)	1" (.02)
150,000	3/4" (.02)	1" (.02)	1" (.02)	1" (.02)	1-1/4" (.03)
200,000	3/4" (.02)	1" (.02)	1" (.02)	1" (.02)	1-1/4" (.03)
250,000	1" (.02)	1" (.02)	1-1/4" (.03)	1-1/4" (.03)	1-1/4" (.03)
300,000	1" (.02)	1-1/4" (.03)	1-1/4" (.03)	1-1/4" (.03)	1-1/4" (.03)
350,000	1" (.02)	1-1/4" (.03)	1-1/4" (.03)	1-1/4" (.03)	1-1/4" (.03)
400,000	1" (.02)	1-1/4" (.03)	1-1/4" (.03)	1-1/4" (.03)	1-1/4" (.03)

Minimum and Maximum inlet supply pressures are as follows:

Natural gas - 5.5" w.c. (1.37kPa) - 10.5" w.c. (2.61kPa).

Propane (LP) gas - 10" w.c. (2.49kPa) - 14" w.c. (3.48kPa).

The pipe diameter may be reduced one size if propane (LP) gas is used. Use steel pipe and Malleable iron fittings for gas service lines.

Provide rigid supports for the pipe. If pipe size must be reduced use reducing couplings only.

Avoid the use of reducing bushings. Remove all burrs and inspect the pipe for dirt or other foreign material.

A manual main gas shutoff valve is to be installed approximately 5 feet (1.5m) above the floor level. A tee is located on the vertical drop at an appropriate level to attach the burner gas valve. The gas line extends down to the floor with a cap on the end (See figure 5). Connect the gas pipe to the burner manifold with a ground joint union. Pipe dope that is resistant to the action of LP gases must be used. Be sure to provide a 1/8 inch (.32cm) NPT plugged tapping accessible for test gauge connection immediately upstream of the gas supply connection to the conversion burner.

FIGURE 5 - PIPING CONNECTION

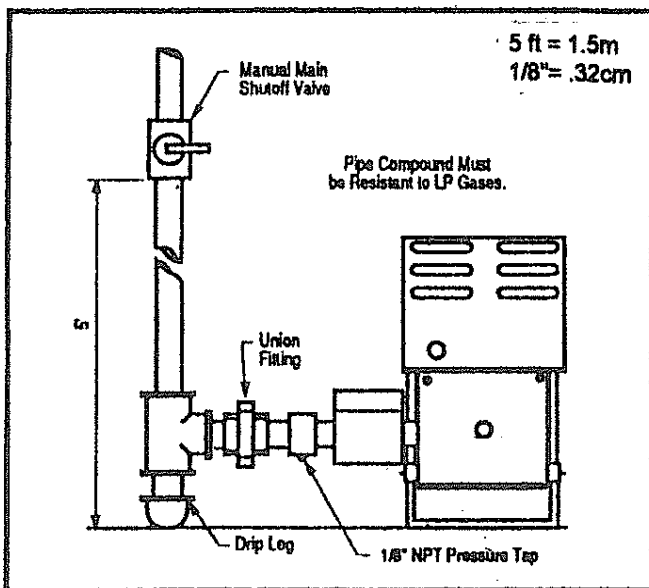

The appliance and its individual shutoff valve must be disconnected from the gas supply piping system during any pressure testing of that system at test pressures in excess of 1/2 PSIG (3.45kPa).

The appliance must be isolated from the gas supply piping system by closing its individual manual shutoff valve during any pressure testing of the gas supply piping at tests pressures equal to or less than 1/2 PSIG (3.45kPa).

WARNING: Explosion Hazard! the control can malfunction if it gets wet. Never try to use one that has been - replace it.

Never use a match or open flame for leak detection. Only use soap solution.

MOUNTING AND PLACEMENT OF BURNER

Coal Fired (See Figure 1)

A 16 gage steel plate backed with 2 inches (5.1cm) of fire brick should be installed over the ash pit opening. A 4-1/2 inch (11.5cm) diameter hole should be provided for the burner. The tip of the burner should be pulled back 1 inch (2.54cm) from inside the surface of the fire brick.

All openings which may leak air into the combustion chamber must be sealed with furnace cement or other means. Do not use asbestos.

Oil fired Furnaces - Boilers (See figure 1)

When installing in blast tube openings most oil burner openings have mounting lugs that will fit the gas burner mounting flange.

All openings which may leak air into the combustion chamber must be sealed with furnace cement or other permanent means. Do not use asbestos.

CHECK-OUT PROCEDURE BEFORE LIGHTING

Preliminary Steps

Be sure all valves are closed. Turn on electric power and gas at the meter. Check for leaks using a soap solution. Bleed the gas line to let the air out. This can be done by disconnecting the pilot line from the valve and setting the valve on "pilot". Except for models with intermittent ignition, bleed air out the 1/8 inch (.32cm) NPT pressure tap upstream of the gas valve (See Figure 6). Depress the red button on the VR8300A control and a controlled gas flow will come from the pilot line opening. Be sure to burn the escaping gas. Watch the meter until one cubic foot (.03 cubic meters) is bled out and then seal the line carefully again. Check for leaks by using a soap solution.

FIGURE 6

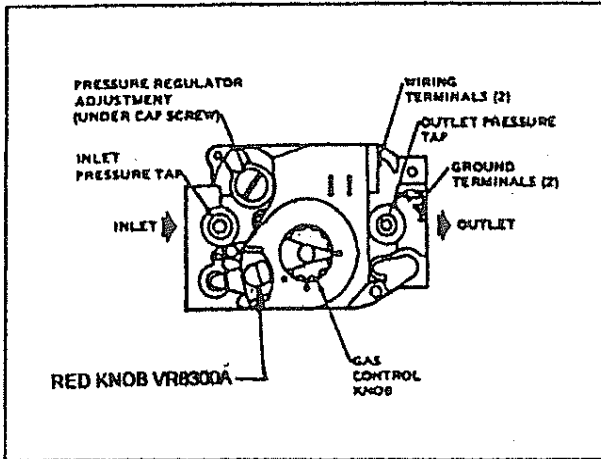

Note: For best pilot ignition be sure that the spark from the ignition electrode goes to the pilot burner head which is adequately grounded for this purpose. A 1/8 inch (.32cm) gap should be maintained. If not, adjustment may be accomplished by use of thin pliers (See Figure 7).

FIGURE 7

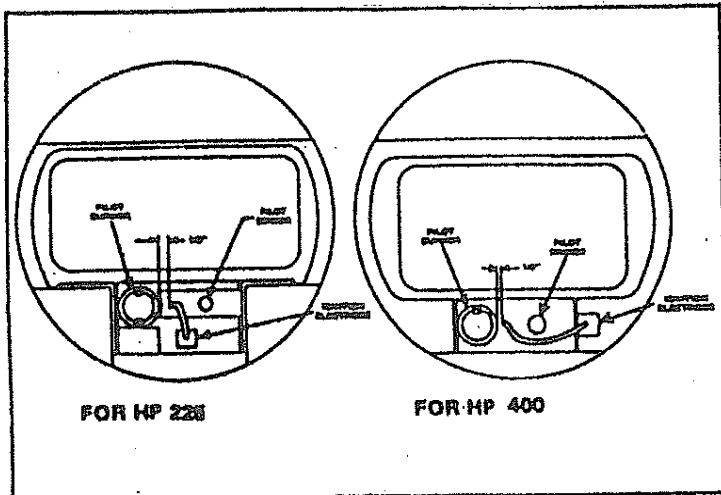

LIGHTING AND SHUT-DOWN INSTRUCTIONS FOR "B" SUFFIX MODELS

A.) Standing pilot with piezo ignition

- 1.) Set room thermostat below room temperature.
- 2.) Be sure gas cock on the combination control is in "OFF" position for five minutes.
- 3.) Turn combination controls gas cock to "Pilot" position and depress the red button.

- 4.) Press button on the spark ignitor repeatedly (See Figure 8) until pilot lights. Continue to depress red button for one minute.
- 5.) Turn gas cock to "ON" position.
- 6.) Set room thermostat above room temperature and turn on electric switch.
- 7.) Set room thermostat to temperature desired.

B.) Automatic Pilot Lighter

- 1.) Set room thermostat below room temperature.
- 2.) Be sure gas cock on combination control is in "OFF" position for five minutes.
- 3.) Turn on main electric switch. Ignitor should spark at the rate of one or two times per second.
- 4.) Turn combination controls gas cock to "Pilot" and depress red button. Hold red button for one minute after sparking noise stops indicating pilot is lit.
- 5.) Turn gas cock to "ON" position. Set thermostat above room temperature. Burner will light.
- 6.) Set thermostat to desired room temperature.

To Shut Off Burner

- 1.) Turn gas knob on combination control to "OFF".
- 2.) Turn off electric switch.

LIGHTING AND SHUT-DOWN INSTRUCTIONS FOR "PS" MODELS

- 1.) Be sure gas cock on combination control is in "OFF" position for five minutes.
- 2.) Open gas cock on combination control to "ON" position.
- 3.) Turn electric switch on.

4.) Set room thermostat above room temperature.
Burner will light.

5a.) Burners equipped with an EPI ignition system (identified by the presence of one relay on the printed circuit board on the underside of the air housing) will light-off almost immediately with no lockout time involved.

IMPORTANT: This burner system must not under any circumstances be used with any liquefied petroleum or other heavier than air gases, otherwise a dangerous operating condition will result.

5b.) Burners equipped with an EPI-100 ignition system (identified by the presence of two relays on the circuit board on the underside of the air housing) will light-off almost immediately. If no ignition happens, 100 percent lockout occurs. This ignition system may be used with both natural and liquefied petroleum gases.

6.) Set room thermostat to temperature desired.

To Shut Off Burner

1.) Turn gas knob on valve to "OFF".

2.) Turn off electric switch.

DETERMINING GAS RATE

To check the input rate, clock the meter for one cubic foot. The best way is to clock the fastest turning dial for one revolution and then divide by the number of feet per revolution. This time in seconds "T" should be used in the following formula:

$$3600 \times \text{H.V. of gas} \div T = \text{BTU/HR.}$$

Heating value "H.V." may be from your local gas company. Fine adjustment of rate can be made with the regulator adjustment on the combination valve.

Be sure to turn off all other appliances when determining gas input rating.

Coal Fired

In order to determine approximately the needed Btu per hour input required for a particular house, multiply the number of rooms (not including hallways, closets and bathrooms) by 25,000. For example: a home having 6 rooms - three bedrooms, dining room, living room and kitchen - would require an input of approximately 150,000 Btu per hour. It must be understood that the above method is an approximate one.

Boilers are usually rated by square feet (meters square) of radiation. Input ratings for steam boilers are figured at 400 Btu per square foot (meters square) radiation while hot water boilers are figured at 240 Btu per square foot (meters square) of radiation. Burner rating should not exceed 650 Btu per Square inch (centimeters square) of grate or combustion floor area.

Oil Fired

Obtain oil firing rate from the furnace name plate or burner nozzle, this will give the Btu per hour input of gas required.

Example:

2 gals. of oil rating
2 x 120,000 = 240,000 Btu per hour gas input rate.

SETTING GAS INPUT RATE

Fixed Orifice

Orifice Size and Capacity - in BTU/HR
If an input that is not shown in Table II is desired, drill out the closest smaller orifice to a size referred to in Table 3. Burner designed for LP gases will have one minimum rate orifice installed. This should be removed and drilled out to the desired rate.

TABLE 3

BTU/HR	NAT. GAS 3.5" W.C. (.87kPa)	LPG 10" W.C. (2.5kPa)
50,000	No. 30DMS	5/64" (.20cm)
75,000	No. 20DMS	No. 40DMS
100,000	3/16" (.48cm)	No. 33DMS
125,000	No. 4DMS	1/8" (.32cm)
150,000	No. 1DMS	No. 29DMS
175,000	D	No. 25DMS
200,000	17/64" (.44cm)	5/32" (.40cm)
225,000	9/32" (.71cm)	No. 20DMS
250,000	19/64" (.75cm)	11/64" (.44cm)
275,000	5/16" (.79cm)	No. 14DMS
300,000	21/64" (.83cm)	No. 10DMS
325,000	11/32" (.87cm)	No. 7DMS
350,000	S	No. 5DMS
375,000	23/64" (.91cm)	No. 4DMS
400,000	U	7/32" (.55cm)

These are approximate drill sizes and will vary with local heating values supplied.

Adjustable Orifice

The HP225 model can be supplied with an adjustable orifice in place of a fixed orifice. This cap is located on the back of the cast iron manifold. This cap must be removed with the burner in operation. Inside the uncovered fitting is a needle with a screwdriver slot. This is turned to the right for less gas and to the left for more gas.

Insert screwdriver and turn clockwise until the pin seats in the orifice. Do not force. Refer to Table 4 for approximate rating. Do not attempt to seat needle in orifice as it will go thru and fall.

Always check meter for final adjustment.

TABLE 4

No. Turns	225 Model
1	36,500
2	70,500
3	98,000
4	135,000
5	165,000
6	187,500
7	205,000
8	215,000
9	220,000
10	225,000

AIR ADJUSTMENT FOR PROPER COMBUSTION

To properly set up a conversion burner a CO₂ analyzer is essential.

1. Select air setting with air adjustment screw on the conversion burner so that the flame is blue with a slight orange and yellow tipping at the outer edges (See figure 8).
2. Check CO₂. If lower than 8.5%, insert a baffle assembly as shown in figure 9. Set this baffle assembly to obtain approximately 9.0% CO₂ for natural gas or 10.0% CO₂ for LPG.
3. Check flue gas temperatures ahead of the draft diverter. These should be between 450°F (232°C) and 550°F (288°C).

FIGURE 8

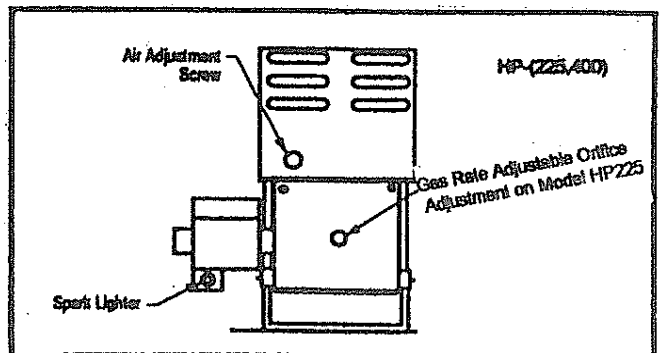
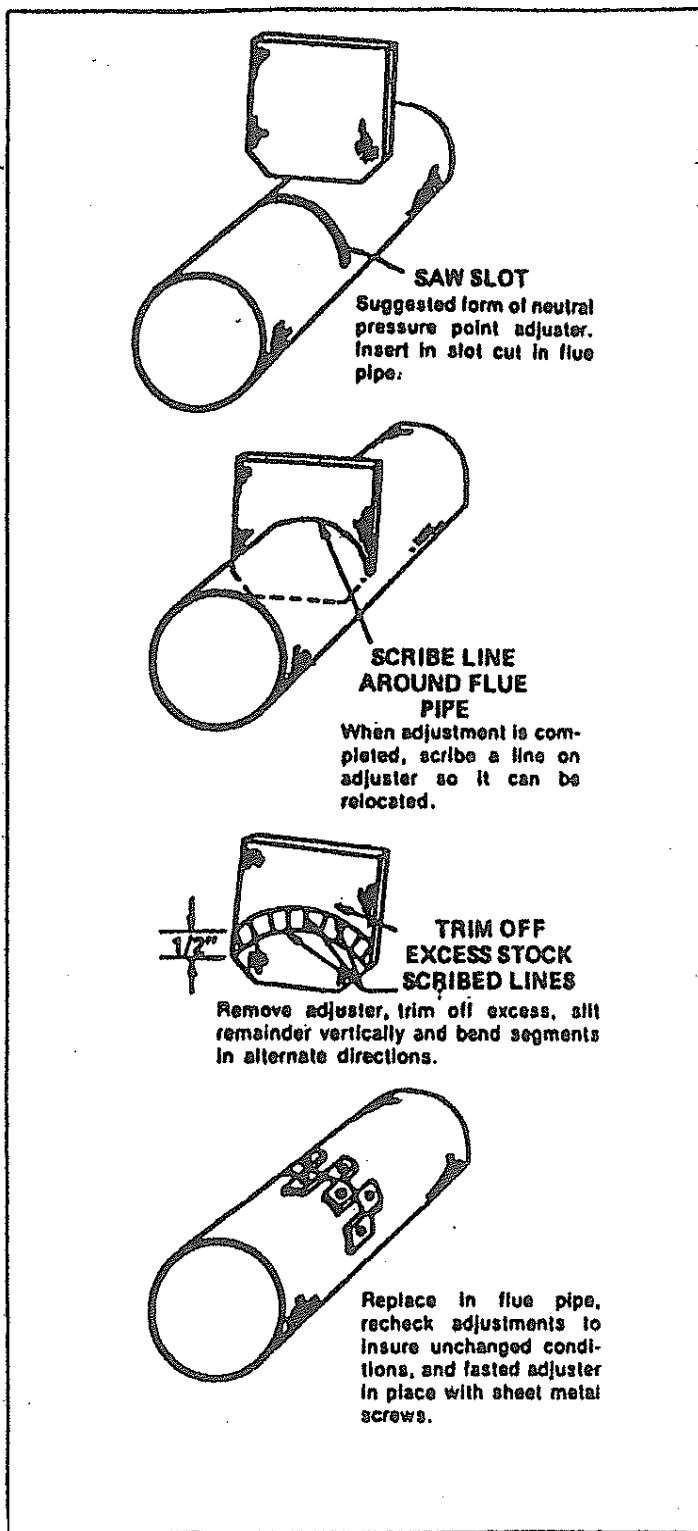

FIGURE 9 SUGGESTED CONSTRUCTION OF A NEUTRAL PRESSURE POINT ADJUSTER



SERVICE AND MAINTENANCE

Make sure gas and electricity have been turned off before servicing.

A qualified gas service agency must be contacted once a year for complete servicing including the appliance in which it is installed and for other than routine maintenance.

To remove the venturi burner, the lower back panel must be removed. The union in the gas line must be opened so that the manifold can slide out. Remove the thumb screw at the rear of the venturi and disconnect the pilot line, thermocouple or sensor/electrode leads and electrical leads that are connected to gas valve.

To Remove the slide tray, both back panels must be removed.

Keep area around the conversion burner clear and free from combustible materials, gasoline and other flammable vapors and liquids.

Do not obstruct the flow of combustion/ventilation air.

Periodically check burner and pilot flame (Constant burning pilot only). See third paragraph above for removing burner. Use vacuum cleaner and soft cleaning cloth to clean burner.

Lubricate the motor with several drops of SAE 20 oil every 3-6 months.

Clean the outer painted surface with a soft cloth and soap solution.

TO ADJUST PILOT FLAME: Adjust pilot flow adjustment screw to give a soft, steady flame enveloping the thermocouple as shown in figure 10.

FIGURE 10

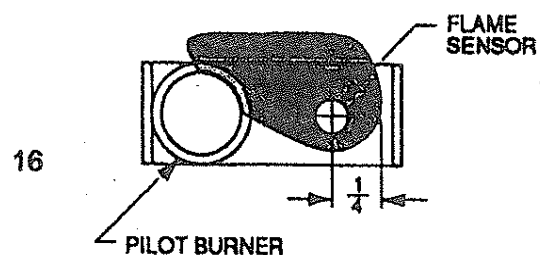

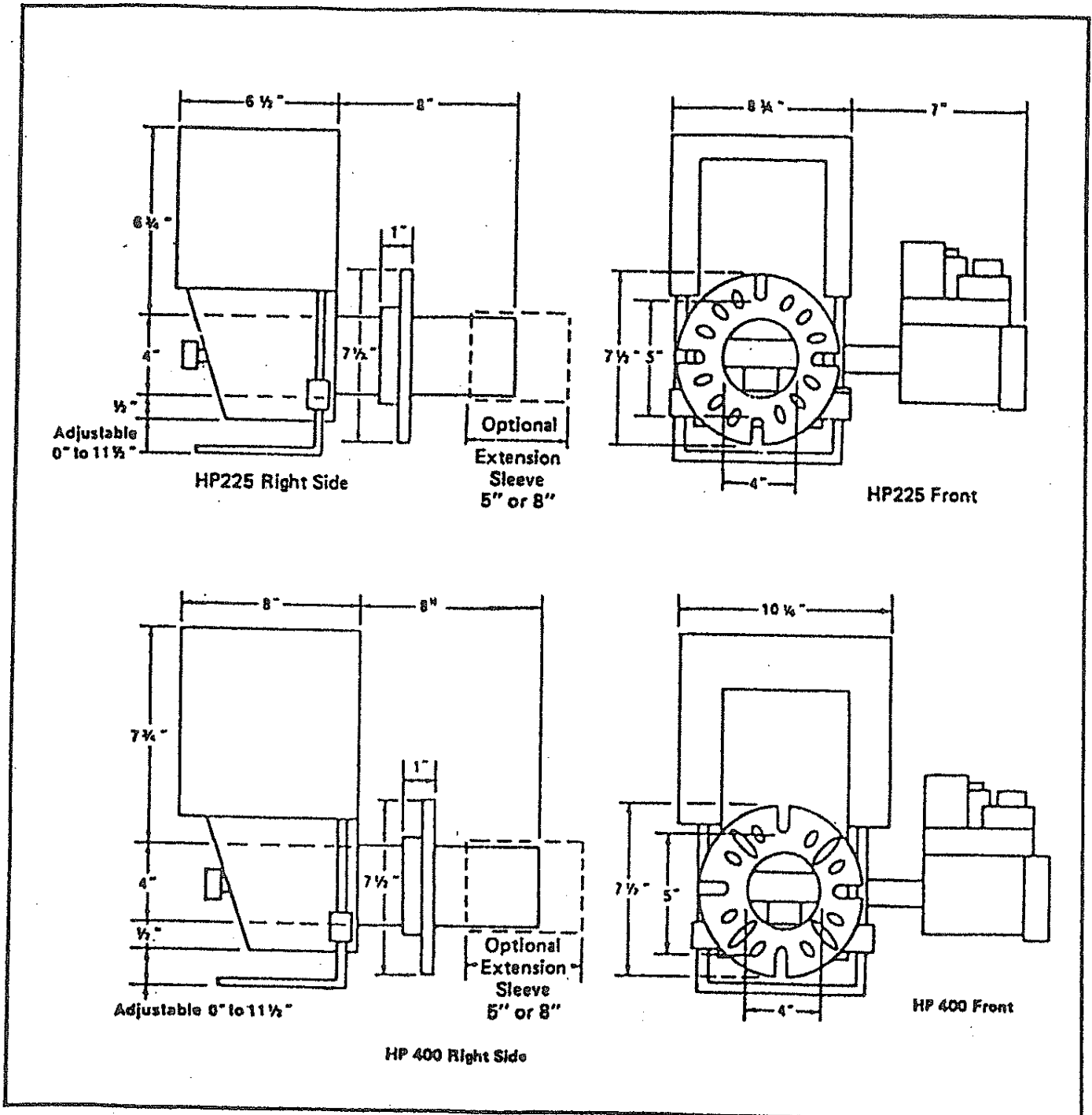

0" = 0 cm	5" = 12.7 cm	7 1/2" = 19 cm	10 1/4" = 26 cm
1/2" = 1.3 cm	6 1/2" = 16.5 cm	7 3/4" = 19.7 cm	11 1/2" = 29.2 cm
1" = 2.54 cm	6 3/4" = 17.1 cm	8" = 20.3 cm	
4" = 10.2 cm	7" = 17.8 cm	8 1/4" = 20.9 cm	

PARTS LIST

R E F	DESCRIPTION	CONSTANT BURNING PILOT MODLES		GAS SAVER MODELS WITH CYCLING PILOT	
		HP-225B	HP-400B	HP-225BPS	HP-400BPS
1	Top Housing	7582-GN	7602-GN	7582-GN	7602-GN
2	Thermocouple	K16CA	K16CA		
2	Sensor Probe				
3	Pilot Burner	J124DDA	J997DDA	J124DDA	J124DDA
4	Pilot Orifice (Nat.)	5221 (.021)	7221 (.021)	5221 (.029)	5221 (.029)
4	Pilot Orifice (LP)	3215 (.015)	3215 (.015)	5221 (.021)	5221 (.021)
5	Ignition System	MPR-1-17	MPR-1-17	EPI-200-2	EPI-200-2
6	Transformer (20VA)	AT20A	AT20A	AT20A	AT20A
7	Relay	R8222A1002	R8222A1002	R8222A1002	R8222A1002
8	Terminal Block	7586-3	7586-3	7586-3	7586-3
9	Air Door	7582A	7608A	7582A	7608A
10	Bottom Access Door	7587B	7607A	7587B	7607A
11	Side Tray Assembly	7586C	7606B	7586D	7606C
12	Manifold	7015D-6	7015D-8	7015D-6	7015D-8
13	Pedestal (Not Shown)	7584	7584	7584	7584
14	Burner Casting	7583-1	7603-1	7583-1	7603-1
15	Insulating Boot	846	846	846	846
16	Pilot Shield	2D12-7	2D12-96-MS-1	12005	2D12-96-PS-1
17	Electrode (3 Inch)	7583-5A	7583-5A	7583-5A	7583-5A
18	Combination Valve (Nat.)	VR8300A4003	VR8300A4003	VR8304M3103	VR8304M3103
18	Combination Valve (LP)	VR8300A4003LP	VR8300A4003LP	VR8304M3103LP	VR8304M3103LP
19	Pipe Nipple	50001-6-3 1/2	50001-6-3 1/2	50001-6-3 1/2	50001-6-3 1/2
20	Main Orifice (Specify Size)	172	172	172	172
21	Adjustable Orifice Assembly	6481		6481	
22	Bottom Housing Assembly	7581B	7601A	7581B	7601A
23	Mounting Plange (Optional)	7585	7585	7585	7585
24	Motor/Blower Assembly	7586-2A	7606A-2	7586-2A	7606A-2
25	APR Module (Optional)	APR-1	APR-1		
26	Extension Sleeve (Not shown)	7581-1A-BL	7581-1A-BL	7581-1A-BL	7581-1A-BL
27	Ignition Wire (30 Inch)			7803	7803
28	Sensor Wire (30 Inch)			7852-2	7852-2

HP Series

